

# BRYSTON

**3BSST<sup>2</sup>**  
**4BSST<sup>2</sup>**  
OWNER'S MANUAL

## IMPORTANT SAFETY INSTRUCTIONS



The lightning flash with arrowhead symbol within an equilateral triangle, is intended to alert the user to the presence of un-insulated "dangerous voltage " within the product's enclosure that may be of sufficient magnitude to constitute a risk of electric shock to persons.



The exclamation point within an equilateral triangle is intended to alert the user to the presence of important operating and maintenance (servicing) instructions in the literature accompanying the product.

1. Read these instructions.
2. Keep these instructions.
3. Heed all warnings.
4. Follow all instructions.
5. Do not use this apparatus near water.
6. Clean only with dry cloth.
7. Do not block any ventilation openings. Install in accordance with the manufacturer's instructions.
8. Do not install near any heat sources such as radiators, heat registers, stoves, or other apparatus (including amplifiers) that produce heat.
9. Do not defeat the safety purpose of the polarized or grounding-type plug. A polarized plug has two blades with one wider than the other. A grounding type plug has two blades and a third grounding prong. The wide blade or the third prong are provided for your safety. If the provided plug does not fit into your outlet, consult an electrician for replacement of the obsolete outlet.
10. Protect the power cord from being walked on or pinched particularly at plugs, convenience receptacles, and the point where they exit from the apparatus.
11. Only use attachments/accessories specified by the manufacturer.
12. Use only with the cart, stand, tripod, bracket, or table specified by the manufacturer, or sold with the apparatus. When a cart is used use caution when moving the cart/apparatus combination to avoid injury from tip-over.
13. Unplug this apparatus during lightning storms or when unused for long periods of time.
14. Refer all servicing to qualified service personnel. Servicing is required when the apparatus has been damaged in any way, such as power-supply cord or plug is damaged, liquid has been spilled or objects have fallen into the apparatus, the apparatus has been exposed to rain or moisture, does not operate normally, or has been dropped.



**WARNING: TO REDUCE THE RISK OF FIRE OR ELECTRIC SHOCK, DO NOT EXPOSE THIS APPARATUS TO RAIN OR MOISTURE.**

**DO NOT EXPOSE THIS EQUIPMENT TO DRIPPING OR SPLASHING AND ENSURE THAT NO OBJECTS FILLED WITH LIQUIDS, SUCH AS VASES, ARE PLACED ON THE EQUIPMENT.**

**TO COMPLETELY DISCONNECT THIS EQUIPMENT FROM THE AC MAINS, DISCONNECT THE POWER SUPPLY CORD PLUG FROM THE AC RECEPTACLE.**

**THE MAINS PLUG OF THE POWER SUPPLY CORD SHALL REMAIN READILY OPERABLE.**

## BRYSTON LIMITED WARRANTY

Bryston analog audio products are warranted to be free from manufacturing defects for twenty (20) years from the original date of manufacture. The warranty includes parts and labour.

Bryston digital products and cables are warranted for five years from the original date of manufacture. The warranty includes parts and labour.

Bryston products having motorized moving parts, excluding motorized volume controls, are warranted for three years from the original date of manufacture. The warranty includes parts and labour.

Bryston will remedy the problem by repair or replacement, as we deem necessary, to restore the product to full performance. Bryston will pay return shipping only for the full length of the specific product's warranty.

In the event of a defect or malfunction, contact Bryston's repair centers for return authorization. Products must be returned using original packaging material only. Packing material may be purchased from Bryston if necessary. This warranty is considered void if the defect, malfunction or failure of the product or any component part was caused by damage (not resulting from a defect or malfunction) or abuse while in the possession of the customer. Tampering by persons other than factory authorized service personnel or failure to fully comply with Bryston operating instructions voids the warranty.

This warranty gives you specific legal rights and you may also have other rights which may vary from province to province and country to country.

As of 2006-02-22 Bryston will only warranty Bryston products purchased through authorized Bryston dealers. Bryston products with a date code of 0608 or higher (date code format is "yyww", where "yy" is the two least significant digits of the year and "ww" is the week of the year) must be accompanied by a copy of the bill-of-sale from a Bryston authorized dealer to qualify for warranty service. The warranty is transferable from the original owner to a subsequent owner as long as a copy of the bill-of-sale from the original authorized Bryston dealer accompanies the re-sale. The copy of the bill of sale to any subsequent owner need ONLY include the Name of the Bryston Authorized Dealer and the Model and Serial number of the Bryston product. The warranty will only be honored in the country of the original purchase unless otherwise pre-authorized by Bryston.

### BRYSTON SERVICE in CANADA:

Postal address: **PO. BOX 2170, Stn. Main  
PETERBOROUGH, ONTARIO  
CANADA K9J 7Y4**

Courier address: **677 NEAL DRIVE  
PETERBOROUGH, ONTARIO  
CANADA K9J 6X7**

PHONE: 705-742-5325  
FAX: 705-742-0882  
E-mail: [cdnser@bryston.com](mailto:cdnser@bryston.com)

### BRYSTON SERVICE in the USA:

**79 COVENTRY ST., Suite 5  
NEWPORT, VERMONT  
U.S.A. 05855-2100**

PHONE: 802-334-1201  
FAX: 802-334-6658  
E-mail: [usaser@bryston.com](mailto:usaser@bryston.com)

### BRYSTON SERVICE outside Canada and the USA:

contact your local distributor or

CHECK OUR WEB SITE: [www.bryston.com](http://www.bryston.com)  
E-MAIL BRYSTON DIRECTLY: [cdnser@bryston.com](mailto:cdnser@bryston.com)  
FAX BRYSTON DIRECTLY: 01-705-742-0882  
PHONE BRYSTON DIRECTLY: 01-705-742-5325

# TABLE of CONTENTS

Safety Instructions, Warranty and Contact Information .....	<b>Opposite</b>
<b>General Information .....</b>	<b>Page 1</b>
Introduction	
3Bsst <sup>2</sup> Description	
4Bsst <sup>2</sup> Description	
Shipping & Packing Materials	
Ventilation	
Wiring the Amplifier	
A/C Power	
Power Conditioners	
<b>Front Panel .....</b>	<b>Page 2</b>
Power Switch	
LED Indicators	
<b>Rear Panel &amp; Inputs/Outputs .....</b>	<b>Page 3</b>
Input Select Switch	
Balanced Input Connector	
Single-ended Input Connector	
Input Sensitivity Switch	
MODE Switch (Bridged vs. Individual mode)	
Level Control	
Outputs (Binding Post Connectors)	
Circuit Breaker.....	<b>Page 4</b>
A/C Power Inlet	
External Control Voltage Power-Up	
<b>Bridged Mode .....</b>	<b>Page 5</b>
<b>Technical Specifications.....</b>	<b>Page 6</b>
<b>3Bsst<sup>2</sup> Exterior Dimensions.....</b>	<b>Page 7</b>
<b>4Bsst<sup>2</sup> Exterior Dimensions.....</b>	<b>Page 8</b>

## GENERAL INFORMATION

### INTRODUCTION

Thank you for choosing an **SST<sup>2</sup> SERIES Stereo Power Amplifier**.

Bryston welcomes any suggestions you may have, or comments regarding the operation of your amplifier. We consider you, our customer, to be Bryston's most important resource, and your opinion is very much appreciated.

### DESCRIPTION 3BSST<sup>2</sup>

The **3BSST<sup>2</sup>** is a *dual mono* design audio power amplifier with two channels of 150W each. Each channel has switch selectable balanced and single ended inputs and independent gain selections of 29dB or 23dB. These SST<sup>2</sup> amplifiers also have *SoftStart* power control circuitry to eliminate high inrush currents when A/C power is applied. The power-up or turn-on of the 3BSST<sup>2</sup> may be activated by the push-button switch located on the front panel or by hard wired remote control voltage.

### DESCRIPTION 4BSST<sup>2</sup>

The **4BSST<sup>2</sup>** is a *dual mono* design audio power amplifier with two channels of each. Each channel has switch selectable balanced and single ended inputs. Each channel also has switch selectable gains of 29dB(1v) or 23dB(2v). The 4BSST<sup>2</sup> includes *SoftStart* power control circuitry to eliminate high inrush currents when A/C power is applied. The power-up or turn-on of the 4BSST<sup>2</sup> may be activated by the push-button power switch on the front panel or via hard wired remote control voltage.

### SHIPPING BOX & PACKING MATERIAL

Please keep the original shipping box and all packing material. This will ensure the amplifier is protected in future transport. In the unlikely event you have a problem and must return it for service you must use the proper packing material. Ship the amplifier only in the original packing material, as the unit is not insurable by carriers otherwise. Replacement packing materials, consisting of a shipping carton with plastic foam inserts, is available from Bryston.

### VENTILATION

The most important installation consideration is ventilation. All SST<sup>2</sup> amplifiers are convection cooled. Unrestricted air-flow across its heat sinks is a must. For this reason do not install anything directly above it. Allow at least 3.5 inches (2 rack units of 1.75" each) of space above and 1" to either side of this amplifier. Do not install directly above other heat generating equipment. Should your installation conditions be constricted, then additional forced air-cooling may be necessary. Bryston can provide an optional fan package if required. Any SST<sup>2</sup> channels thermally shutting down during operation indicates insufficient air flow, and a remedy must be found for cooling the amplifier. Provide a minimum 6" space to the rear of the amplifier for ventilation and dressing cables to and from the amplifier.

***Never operate the amplifier in a vertical position.***

### WIRING THE SST<sup>2</sup> AMPLIFIER (also see rear panel description)

**Speaker wires** should be as short as practical. Use quality wire, and if runs are more than 3 meters use at least 12 gage wire. The speaker binding posts will accept wire up to 3 gage in size. Bryston will custom build cables for your application.

### A/C POWER

Before plugging in the power cord be sure your SST<sup>2</sup> amplifier is specified for the **correct a/c voltage** for your locality. The voltage is listed on the label found at the upper right of the rear panel. The circuit feeding the 4B SST<sup>2</sup> should be sufficient so as not to cause the circuit breaker to trip. For example, the 4B SST<sup>2</sup> when operated with both channels delivering maximum power into 4 ohm loads will consume all the available power in a normal North American residential circuit (15 Amps), therefore a dedicated electrical circuit may be necessary with this situation. Never lift the safety ground to the amplifier nor remove the ground pin from the plug.

### POWER CONDITIONERS

Bryston urges caution in choosing a power conditioner for your audio/video system. Large power amplifiers can draw very substantial current from the wall plug, and many so-called power conditioners can in fact hinder the supply of current by inserting resistances in series with the line cord. However, there are now power conditioners that can reduce or eliminate RF and 'hash' from the AC supply and may actually improve current delivery to your system. This type of power conditioner (exemplified by 'TORUS' Power Conditioners) uses the energy storage in a large toroidal transformer to provide high instantaneous power and reduce the substantial AC output resistance of the wall socket and house wiring. This resistance can be in the range of 0.5 to 1 Ohm and is typically reduced to only a few milli-ohms by the Power Conditioner. That in turn considerably reduces Voltage drop in the power line on high current surges and quite substantially increases the stability of the power line improving audio (and video) focus, precision and clarity.



### 1. POWER SWITCH

The front panel label  is a push-on/push-off type push-button power switch used to apply or remove a/c line power to the *SoftStart* circuitry. Note that the rear circuit breaker must be on for the amplifier to power-up.

### 2. L·E·D INDICATORS

Each SST<sup>2</sup> channel has a LED indicator to monitor the following conditions:

- UNLIT - indicates channel has no power.
- RED - indicates channel is muted (power-up)
- GREEN - indicates channel operation is normal.
- FLASHING RED - indicates channel clipping.
- ORANGE - indicates channel thermal shutdown.

#### POWER UP SEQUENCE

After pushing the power switch (① in the picture above), each channel LED will turn from unlit to red (mute). When the power supplies have stabilized the channel will come out of mute and the LED will change to green (normal operation).

#### UNLIT L·E·D ( No power )

The SST<sup>2</sup> channel LED when unlit indicates no A/C mains power is present at the channel. If both channel LED indicators are unlit the amplifier probably needs only to be powered on.

#### CLIPPING ( flashing red )

Clipping occurs when the channel output level no longer can follow the level increase at the input (Over driven input condition). When an SST<sup>2</sup> channel is driven into clipping the channel LED will change from green to red then back to green when the level is reduced ( Flashing Red ). Momentary clipping can be tolerated, however it indicates that maximum undistorted power has been surpassed and potential speaker damage may result if overload conditions persist. Any amplifier that is constantly operated into clipping indicates a more powerful amplifier is needed for that application.

#### THERMAL SHUTDOWN ( orange )

Each channel has thermal shutdown circuitry to prevent damage due to overheating. Should thermal shutdown occur, the channel will mute, and the channel LED will turn orange indicating this condition. When the channel has cooled to a safe operating condition the channel will return to normal operation. Persistent Thermal shutdown indicates steps need to be taken to increase airflow across the channel or channels heat sink. ( Also see installation section on ventilation ).

N.B. In some markets the LED indicators, which are normally red/green, may be red/blue instead. When red/blue LEDs are supplied green is replaced with blue and orange is replaced with magenta in the above descriptions.

## REAR PANEL & INPUT/OUTPUT CONNECTIONS

### 1. INPUT SELECT SWITCH

Each SST<sup>2</sup> channel gives the user the option of switching between either balanced input or single ended input.

### 2. BALANCED INPUT CONNECTOR

This input connector accepts standard XLR (pin 1=Gnd, pin 2=Positive, pin 3=Negative) or 1/4" Phone plugs (sleeve=Gnd, tip=Positive, ring=Negative). Use quality, 100% shielded cables with gold plated connectors.

### 3. SINGLE ENDED INPUT

This input connector accepts standard 'RCA' or 'Phono' connectors. Use quality, 100% shielded cables with gold plated connectors.

#### **Balanced input Vs Single ended input:**

The balanced input requires a balanced pre-amp source. Balanced systems provide noise rejection from external electrical interference, so cable length can be very long ( 50m or longer ). The single ended or unbalanced input is provided for pre-amps without balanced output. Single-ended cables should be kept to 20' (7m) or less. In general never use longer cables than necessary, never coil excess cable length, and keep signal wires away from AC power or speaker cables.

### 4. INPUT SENSITIVITY (GAIN) SWITCH

The optimum gain setting will depend upon the source pre-amp operating level, and or personal preference.

The 29dB setting is used when the source is *single-ended*, or from a transformer coupled *balanced* source. This is the *home theatre* setting for *single ended* or un-balanced operation. The **29dB** setting provides the most amplifier gain and equates to 100w @ 8 ohms output for a 1v input. (noise -110 dB)

The 23dB setting is used when the sources output is actively *Balanced*. This is the *home theatre* setting for balanced operation Or use this setting wherever less gain is required. The **23dB** setting equates to an output of 100w @ 8 ohms for 2v input. ( noise -113 dB )

The noise is referenced in dB below rated output. Different input configurations result in slightly different noise readings. The above noise ratings represent minimum readings, actual readings may be better.

### 5. MODE SWITCH (individual or bridge mode)

The individual setting is for two channel operation. Bridge mode is for mono operation.

### 6. LEVEL CONTROL (PRO models only)

The level control will attenuate the input signal level from 0dB through -14dB.

### 7. OUTPUT BINDING POSTS

The **RED** binding post is connected to the **amplifier output**. Connect to this post the (+) terminal on the loudspeaker for normal (non-bridged or *individual*) operation.

The **BLACK** binding post is connected to **signal ground**. Connect to this post the (-) terminal on the loudspeaker for normal (non-bridged or *individual*) operation.

The Output binding posts provide three different interconnect options. Combinations may be used when bi-wiring. Cables should be kept as short as practical and should never be terminated with connectors that may become confused for AC power connectors. Cables should be dressed away from input and power cables.

**Banana plugs** offer a quick disconnect option. Before inserting a banana plug into the binding post be sure to tighten the post nut to avoid rattling and to provide full insertion of the banana plug. Gold plated locking banana plugs are available from Bryston.

**Spade lugs** provide high contact area and secure fastening. Lugs should be gold plated. Post diameter is 5/16" (8mm ), lug width 5/8" (16 mm). Gold plated spade lugs are available from Bryston.



**Stripped bare wire** up to 3 gage can be inserted through the hole in the binding post and held in place by tightening the post knob. Additional tightening pressure can be achieved using a **coin** in the slots of the knob. Do not over tighten or the binding post may become damaged. Note that copper wire is malleable and may require further tightening after the initial installation.

### 3Bsst<sup>2</sup>/4Bsst<sup>2</sup> REAR PANEL

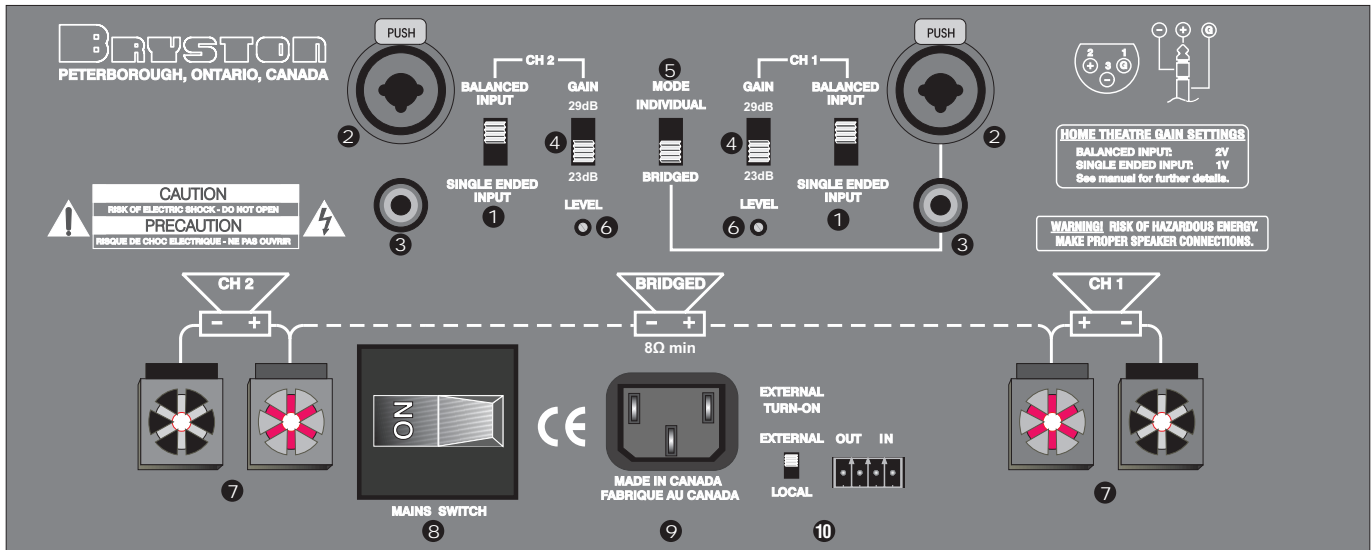

#### 8. MASTER CIRCUIT - BREAKER

The SST<sup>2</sup> amplifier uses a magnetic-trip circuit breaker to protect the amplifier. This switch should be **OFF** during installation. When switched **OFF** all A/C power is removed from the amplifier, including standby power. The circuit breaker is not the power switch and should be switched and left **ON** after the installation is complete. Use the front panel push-button power switch or an external control voltage to power-up or power-down the amplifier. Should the breaker trip, lower or remove the amplifier input signals. Switch the breaker to the 'ON' position. Then power the unit up normally.

**N.B. The circuit breaker must be 'ON' at all times for the SST<sup>2</sup> amplifier to operate.**

#### 9. A/C POWER INPUT

An IEC-320 C14 power inlet provides for connection of an IEC-320 C13 equipped power cord. Before connecting the power cord to the amplifier check that the voltage rating on the data plate or ratings label conforms with your locality. With the circuit breaker 'OFF' insert the power cord into the SST<sup>2</sup> amplifier, then plug the other end to an appropriate A/C power outlet.

#### 10. EXTERNAL CONTROL VOLTAGE POWER UP ( Local / External switch)

A) To power-up the SST<sup>2</sup> amplifier using an external control voltage and supply a 4v to 12v (AC or DC) control voltage to the 'IN' terminals of connector ( 5 ). Use paired wire of 22 to 18 gage between the source device and the SST<sup>2</sup> amplifier. The appropriate mating connector (Bryston part number: 110A-11104 ) is supplied with each amplifier.

Set the *External Turn-On* switch to "External". The amplifier will now power-up only when the control voltage is present (on). Immediately following power-up, the control voltage will appear at the 'OUT' terminals of connector for the control of other equipment. The removal of the control voltage (0v) causes the amplifier to turn 'off' and the control voltage at the 'OUT' terminals is interrupted.

B) In the "Local" setting of the *External Turn-On* switch (#10) the SST<sup>2</sup> amplifier will ignore the control voltage and power up only by using the front panel push-button power switch. If a control voltage is present at the 'IN' terminals it will still be available at the 'OUT' terminals after the power-up sequence.

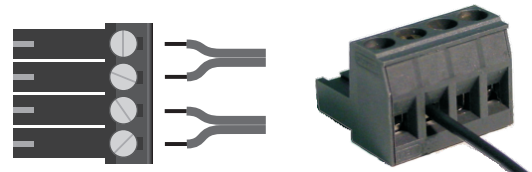

#### REMOTE POWER TURN-ON PLUG-IN CONNECTOR

Insert stripped ends of insulated wires revealing approx. 1/4" of bare, stranded copper wire between 24 and 12AWG (.5mm to 2mm dia.) into open elevator style wire clamps & tighten with a slot screw driver. Do not over tighten or wires may eventually come lose. Maximum tightening torque is 4.5 lb-in (0.5Nm)

Note:

The 'OUT' terminals are connected to the 'IN' terminals once the SST<sup>2</sup> amplifier has powered-up. The control current is determined by the **source** equipment. The carrying current of the 'OUT' relay is 2 amps. The SST<sup>2</sup> control circuitry itself draws less than 2 mA from the control current when operating.

## BRIDGED MODE

"Bridged mode" refers to the combining or "bridging" of two amplifier channels in series to form a single amplifier channel. The primary reason for doing this is to achieve a single amplifier channel with much greater output power. When two 3B channels or two 4B channels are bridged the combined single channel will output up to 2 times the voltage and therefore, theoretically, 4 times the power of a single non-bridged channel. In practice the actual output power achieved is limited by the capability of the power supply as well as the ability of the amplifier to dissipate the increased heat that is generated. It should be noted that the usual minimum load connected to a pair of bridged 3B or 4B channels should be twice the minimum of 4 Ohms, or  $\geq 8$  Ohms.

- Only one input is used: Channel #1 (also referred to as the LEFT input).
- The single input can be either balanced or un-balanced.
- Only the two RED binding post connectors are used (i.e. the black ones are NOT used). The LEFT (Ch. 1) binding post is the *positive* polarity connector and the RIGHT (Ch. 2) RED binding post is *negative*.
- The bridged output is *floating* or un-grounded. **DO NOT CONNECT EITHER OUTPUT TERMINAL TO GROUND.**
- To engage bridged mode, put the MODE switch, located on the rear panel, into the BRIDGED position, but before doing so make sure all input and output connections are correct for bridged mode operation.

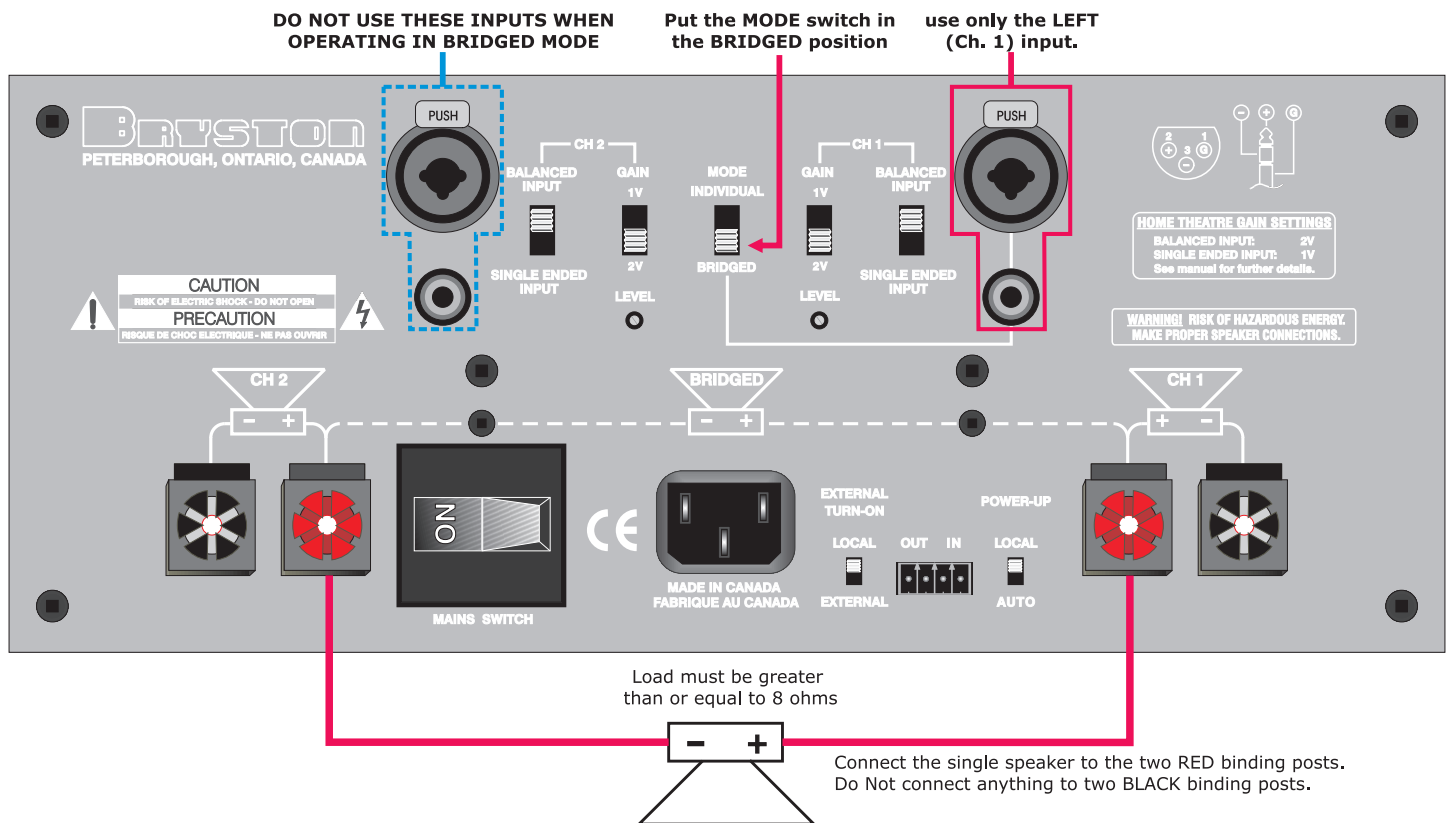



<b>Power Output:</b>	150 watts per channel into 8 ohms 250 watts per channel into 4 ohms
<b>Gain:</b>	High: 29dB = 28.28V/V Low: 23dB = 14.14V/V
<b>Sensitivity:</b>	High: 1.0V <sub>in</sub> = 100W out with an 8Ω load 1.3V <sub>in</sub> = 150W out with an 8Ω load Low: 2.0V <sub>in</sub> = 100W out with an 8Ω load 2.6V <sub>in</sub> = 150W out with an 8Ω load
<b>Input Impedance:</b>	Individual mode: Single ended ≈ 60K Ohms Balanced ≈ 20K Ohms Bridged mode: Single ended ≈ 15K Ohms Balanced ≈ 10K Ohms
<b>IMD or THD + noise:</b>	< 0.005% 20Hz to 20kHz at 150 watts into 8 W < 0.007% 20Hz to 20kHz at 250 watts into 4 W
<b>Noise:</b>	Measured with input shorted, 20 Hz to 20K Hz. >110dB below rated output 29dB gain (- 75 dBu) >113dB below rated output 23dB gain (- 78 dBu)
<b>Slew Rate:</b>	> 60 volts per microsecond
<b>Power Bandwidth:</b>	< 1 Hz to over 100 kHz
<b>Damping Factor:</b>	Over 500 at 20 Hz, ref. 8 ohms
<b>Footprint:</b>	19" version with handles: 48.3cmL x 32.2cmD x 16cmH 19"L x 12.7"D x 6.3"H 17" version: 43.2cmL x 28.3cmD x 16cmH 17"L x 11.2"D x 6.3"H
<b>Weight:</b>	approx. 19.1 Kg (42 lbs)
<b>Power Consumption &amp; Heat Load:</b>	At Idle: 127 Watts Max. Heat Dissipation: 433 BTU/Hr.  2 channels @ 150W @ 8 ohms: 668 Watts Max. Heat Dissipation: 1255 BTU/Hr.  2 channels @ 250W @ 4 ohms: 1096 Watts Max. Heat Dissipation: 2033 BTU/Hr.  Bridged @ 450W @ 8 ohms: 1053 Watts Max. Heat Dissipation: 2057 Btu/Hr.

<b>Power Output:</b>	300 watts per channel into 8 ohms 500 watts per channel into 4 ohms
<b>Gain:</b>	29dB position = 28.28V/V 23dB position = 14.14V/V
<b>Sensitivity:</b>	High: 1.0V <sub>in</sub> = 100W out with an 8Ω load 1.8V <sub>in</sub> = 300W out with an 8Ω load Low: 2.0V <sub>in</sub> = 100W out with an 8Ω load 3.6V <sub>in</sub> = 300W out with an 8Ω load
<b>Input Impedance:</b>	Individual mode: Single ended ≈ 60K Ohms Balanced ≈ 20K Ohms Bridged mode: Single ended ≈ 15K Ohms Balanced ≈ 10K Ohms
<b>IMD or THD + noise:</b>	< 0.005% 20Hz to 20kHz at 300 watts into 8 W < 0.007% 20Hz to 20kHz at 500 watts into 4 W
<b>Noise:</b>	Measured with input shorted, 20 Hz to 20K Hz. >110dB below rated output 29dB gain (- 75 dBu) >113dB below rated output 23dB gain (- 78 dBu)
<b>Slew Rate:</b>	> 60 volts per microsecond
<b>Power Bandwidth:</b>	< 1 Hz to over 100 kHz
<b>Damping Factor:</b>	Over 500 at 20 Hz, ref. 8 ohms
<b>Footprint:</b>	19" version with handles: 48.3cmL x 40.6cmD x 16cmH 19"L x 17.5"D x 6.3"H 17" version: 43.2cmL x 37.6cmD x 16cmH 17"L x 16"D x 6.3"H
<b>Shipping Weight:</b>	approx. 28.6 Kg (63 lbs)
<b>Power Consumption &amp; Heat Load:</b>	At Idle: 170 Watts Max. Heat Dissipation: 580 BTU/Hr.  2 channels @ 300W into 8 ohms: 1280 Watts Max. Heat Dissipation: 2320 BTU/Hr.  2 channels @ 500W into 4 ohms: 2100 Watts Max. Heat Dissipation: 3750 BTU/Hr.  Bridged @ 900W @ 8 ohms: 2040 Watts Max. Heat Dissipation: 3890 BTU/Hr.

# 3Bsst C-Series Power Amplifier EXTERIOR DIMENSIONS

FILE: 3BSST-C-Series-EXTERIOR-DIM  
 PART No: 1  
 REVISION: 2008-02-07  
 Created: 2003-04-29  
 BY: 

**BRYSTON** LTD  
 P.O. BOX 2170, 677 NEAL DRIVE, PETERBOROUGH, ONTARIO, CANADA K9J 7Y4  
 PHONE: 705-742-5329 FAX: 705-742-0882 INTERNET: www.bryston.ca

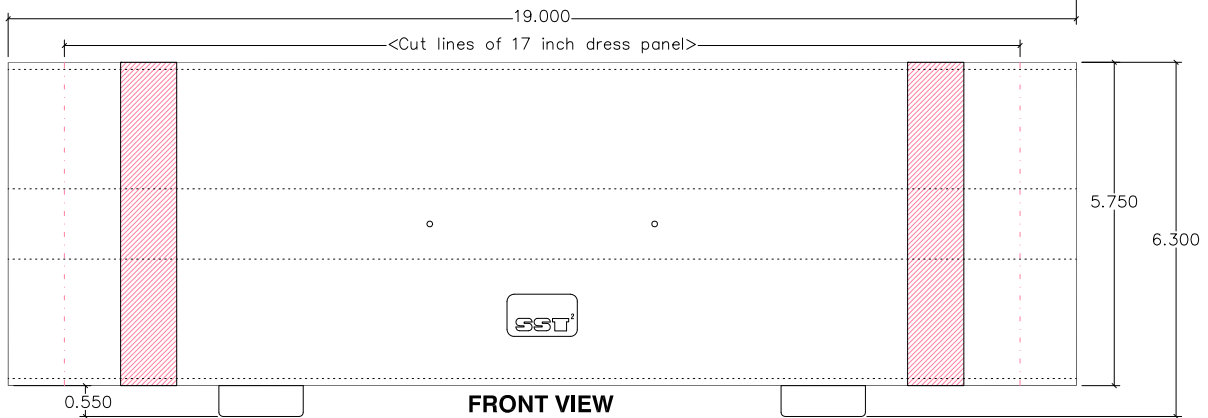
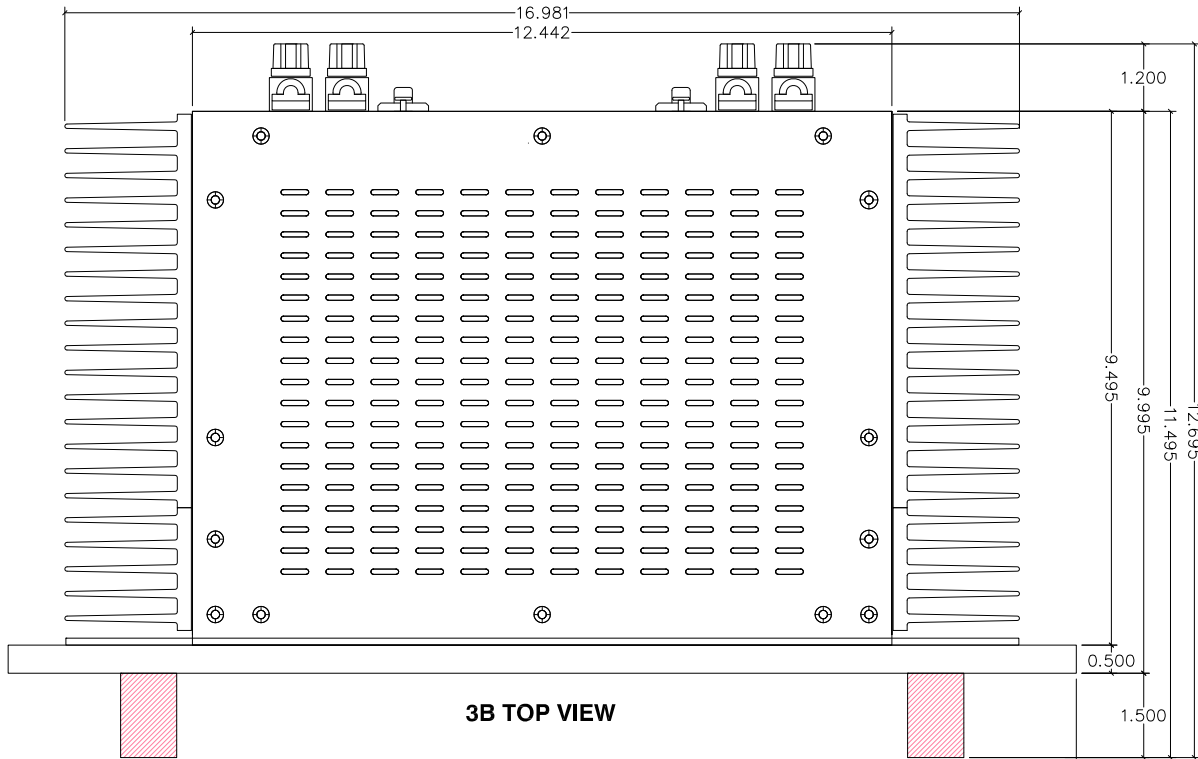
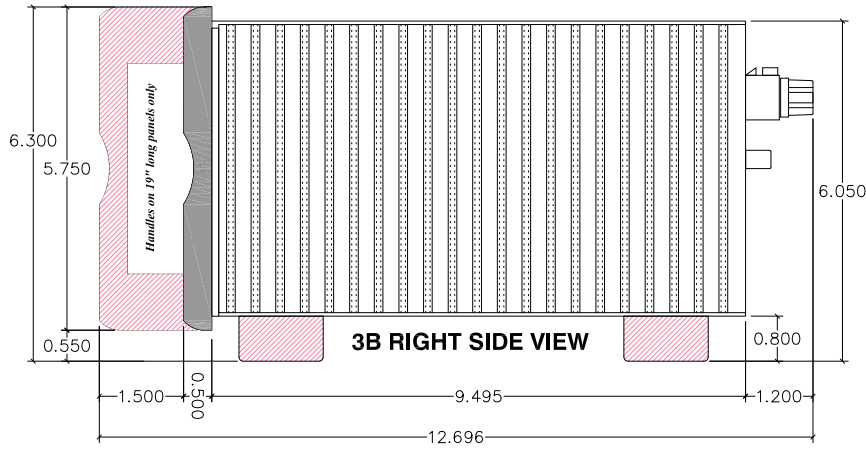

# 4B/7B SST C-Series POWER AMPLIFIERS EXTERIOR DIMENSIONS

FILE: 4B7Bsst-C-Series-EXTERIOR-DIMENSIONS.dwg  
 PART No: -  
 REVISION: 1  
 Revised: 2008-02-20  
 Created: 2003-04-29  
 BY: 

**BRYSTON** LTD  
 P.O. BOX 2170, 677 NEAL DRIVE, PETERBOROUGH, ONTARIO, CANADA K9J 7Y4  
 PHONE: 705-742-5325 FAX: 705-742-0882 INTERNET: www.bryston.ca

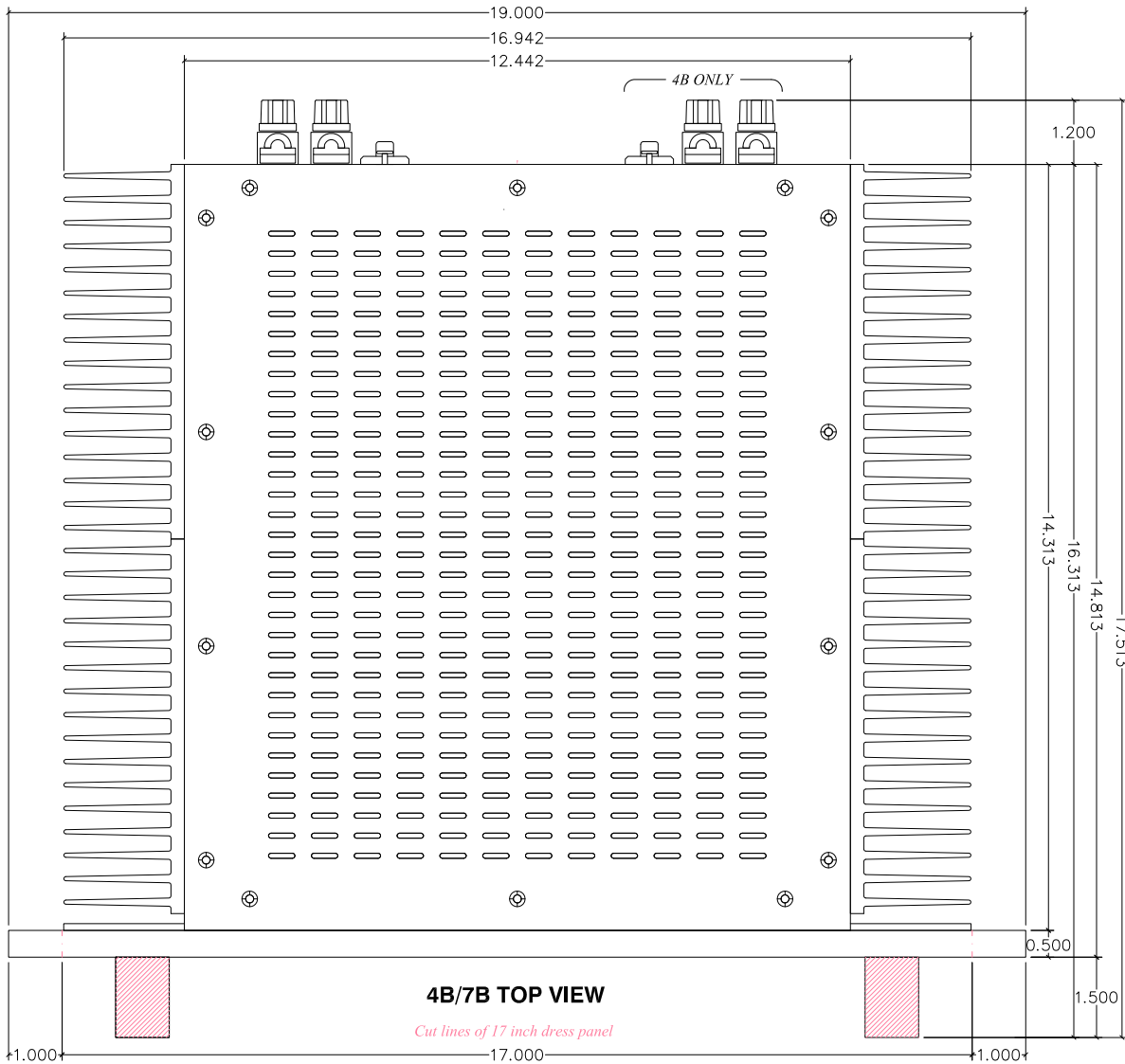
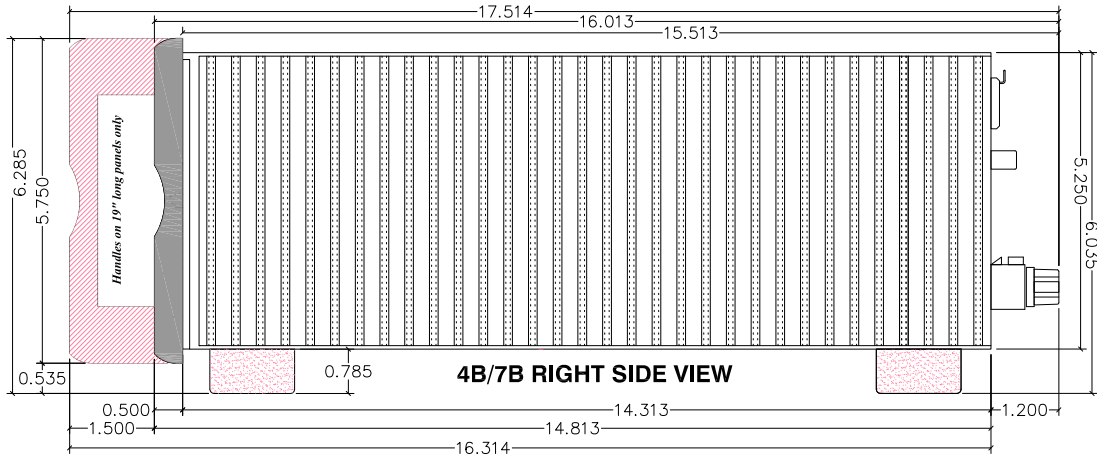

**On 17 inch units the dress panel is 2 inches shorter than the 19" panel (1 inch is removed from either end) and there are no handles.**  
 N.B. Height of rubber feet may vary by  $\pm 0.032$ "

ALL DIMENSIONS IN INCHES

