

Price: \$5.00

MODEL D-115 POWER AMPLIFIER
OWNER'S MANUAL

9-9-83

audio research corporation

6801 SHINGLE CREEK PARKWAY
MINNEAPOLIS, MINNESOTA 55430

TABLE OF CONTENTS

| <u>TITLE</u> | <u>PAGE</u> |
|--|-------------|
| INTRODUCTION | 1 |
| WARRANTY STATEMENT | 1 |
| WARRANTY REGISTRATION CAUTION | 1 |
| USE CAUTIONS | 2 |
| PACKAGING | 2 |
| ACCESSORIES INCLUDED | 3 |
| UNPACKING | 3 |
| PREPARATION FOR USE (INSTALLING TUBES, ETC.) | 3-4 |
| TUBE LOCATION CHART | 4 |
| INSTALLATION | 5 |
| CONNECTION INSTRUCTIONS | 5-6 |
| OPERATING INSTRUCTIONS | 7 |
| ADJUSTMENT PROCEDURE AND DISCUSSION | 7-10 |
| WARRANTY TERMS | 10-11 |
| WARRANTY EXTENSION TERMS | 11 |
| D115 SPECIFICATIONS | 12 |
| ADDENDUM: D115 SCHEMATIC | |

INDEX

| <u>TITLE (ALPHABETICAL)</u> | <u>PAGE</u> |
|--|-------------|
| ACCESSORIES INCLUDED | 3 |
| ADDENDUM: D115 SCHEMATIC | |
| ADJUSTMENT PROCEDURE AND DISCUSSION | 7-10 |
| CONNECTION INSTRUCTIONS | 5-6 |
| D115 SPECIFICATIONS | 12 |
| INSTALLATION | 5 |
| OPERATING INSTRUCTIONS | 7 |
| PACKAGING | 2 |
| PREPARATION FOR USE (INSTALLING TUBES, ETC.) | 3-4 |
| TUBE LOCATION CHART | 4 |
| UNPACKING | 3 |
| USE CAUTIONS | 2 |
| WARRANTY EXTENSION TERMS | 11 |
| WARRANTY REGISTRATION CAUTION | 1 |
| WARRANTY STATEMENT | 1 |
| WARRANTY TERMS | 10-11 |

INTRODUCTION

Please take time to read this manual prior to use or installation of your D115 amplifier.

The D115 is a vacuum tube amplifier constructed to high commercial standards. It is also capable of redefining the state-of-the-art of music reproduction. In order to achieve this, however, it is necessary that it be used synergistically with commensurate quality associated components. Just as a chain is not stronger than its weakest link, so it is in a music playback system. Attention to details such as the quality of interconnect cables, speaker wires, cartridge-arm interface and adjustments will reward you with satisfying results. It is also important that a preamplifier capable of unrestricted musical dynamics be used. Without these considerations you will no doubt hear a difference between this amplifier and others. However, the results may not be gratifying. The computer industry has a saying which is somewhat appropriate here: "Garbage in, Garbage out." Our analogy would be more like that of comparison of a very clean, clear window with one that is only translucent. If the scenery on the other side is pleasant, then the clean, clear window is preferred. So it is with the D115 amplifier. If you do not experience the definitive musical improvement available with this amplifier, a discussion of your system with your authorized Audio Research dealer or our Customer Service Department is suggested.

WARRANTY STATEMENT

A Limited 90-Day Warranty (from the date of purchase by the original purchaser, but must be within two (2) years of the date of manufacture) is provided by Audio Research Corporation. This includes vacuum tubes. This warranty is subject to the conditions and limitations stated within the documents attached to the outer shipping carton and is repeated in full on Pages 10 and 11 of this manual. Please read the following WARRANTY REGISTRATION CAUTION as well as the WARRANTY TERMS on Pages 10 and 11 of this manual to understand your responsibility as well as your rights regarding the warranties.

WARRANTY REGISTRATION CAUTION

It is your responsibility to register your unit. It is true that Audio Research Corporation will provide warranty service for 90 days even if you do not register your unit (proof of purchase, a photocopy of your bill of sale, will be required). However, we offer an extended Limited 3-Year Warranty simply for registration of the unit within 30 days from the date of your purchase. (Note that this extended warranty - if received - does NOT include vacuum tubes.)

Please note that it is not Audio Research's (or your dealer's) responsibility to insure this registration. It is yours, and yours alone. The warranty papers are attached to the carton. Do not delegate this responsibility to anyone else. You can know that your unit is registered only if you do it yourself and if you receive back from Audio Research a validated Warranty Certificate. Audio Research wants you to have the extended Limited 3-Year Warranty. However, the validated warranty will not be issued if the unit is not registered within 30 days of the date of purchase.

Take time now to read Paragraph 1 of the WARRANTY TERMS and WARRANTY EXTENSION TERMS on Pages 10 and 11 of this manual so that you will clearly understand what is required of you in order to accomplish the warranty registration.

USE CAUTIONS

1. Please be certain to read this manual over to familiarize yourself with your new amplifier before placing it in service.
2. Your D115 amplifier's power cord is equipped with a standard three-prong grounding plug which, if used normally, will ground the chassis to the power line. While this procedure provides the maximum possible safety in use, it will, in many cases, cause your audio system to have a residual hum.

It is usually best to keep the preamplifier "earth grounded" and "float" the grounds of power amplifiers and other equipment to eliminate ground loop hum. The audio interconnect cables then keep the power amplifiers at safe earth ground potential. If there is any question as to the safety of grounding procedures, be certain to seek competent help with the installation.

WARNINGS

1. To prevent fire or shock hazard, do not expose this equipment to rain or moisture.
3. This unit contains voltages which can be lethal. Do not operate this unit with its covers removed. Refer servicing to qualified personnel.

CAUTION

For continued protection against fire hazard, replace all fuses only with the same type and rating fuse as specified.

PACKAGING

Save all packaging. Your Audio Research[®] amplifier is a precision electronic instrument and should be properly cartoned any time shipment is made. Because of its weight, it is highly probable that the unit will be damaged during shipment if repackaged in cartoning other than that designed for the unit. It is also important, again because of the unit's weight, to pack each tube separately in its own carton.

You may not have occasion to return the unit to the factory for service, but if that should prove necessary, or other occasion to ship it occurs, the original packaging may save your investment from unnecessary damage, delay and expense.

REMEMBER: Remove all the vacuum tubes from their sockets and package them in the individual cartons to avoid damage in shipment. Mark each tube with its "V" number so that proper relocation can occur at re-installation.

ACCESSORIES INCLUDED WITH YOUR D115 AMPLIFIER

- 1 Phillips screwdriver (for cover removal)
- 1 Plastic screwdriver (for internal adjustments)
- Spare Fuses:
 - 1 - MDX-6 1/4 - 6 1/4 Amp for 120V Units (or)
 - 1 - MDA 8 - 8 Amp for 100V Units (or)
 - 1 - MDA 3.2 - 3.2 Amp for 240V Units
 - 1 - 1A 3AB Screen Fuse (This is a "fast-blow," instrument-type fuse. It is extremely important that only this type and rating be used as the screen fuse.)

UNPACKING

The D115 is packed within two cartons (inner and outer) which have polyfoam panels in between. Because of the weight of the unit and because it is a precision electronic instrument, it is necessary to take reasonable care in its unpacking and preparation for use.

It is best to have a large, open work area available. Set the carton upright in the center of the work area and with a knife or razor blade carefully slit the taped edges of the outer carton's top flaps. Fold the flaps to the sides and while holding the inner carton in place, roll the unit upside down. You can now lift the outer carton off and set it and the foam filler panels aside. Now slit the inner carton's bottom flaps taped edges. Again, fold the flaps over and while holding the unit in, roll it over as before. You can now lift the inner carton off to find your D115 sitting upright, undamaged and uncartoned. Carefully remove the plastic wrap. Now, while you remember how, reassemble the carton system for future use.

PREPARATION FOR USE

Your D115 amplifier is shipped with all of the vacuum tubes removed, packaged and wrapped so that they will not be broken or internally damaged in shipment. It is necessary to install these before using your amplifier.

Seventeen (17) tubes are used in your D115. Eight (8) are KT77 power tubes, one (1) is a 6550 regulator located at the center of the printed wiring board at the rear of the unit and there are also eight (8) small tubes.

Proceed as follows:

1. Using the Phillips screwdriver provided, remove the top cage, setting it and the screws aside.
2. Remove the 17 tubes in their cartons.

Note that each vacuum tube has its own box marked with its "V" number. Using the following procedure, install these tubes carefully, observing the proper locations according to the chart on the next page, and be careful to observe the "keyway" on the base of the 9 large power tubes. Make certain the tubes are properly aligned with the matching keyway in the tube socket and install them firmly without

forcing or undue side-to-side "wiggling." Observe also that the small tubes have 9 pins with a space where a 10th pin might have been located. The sockets are spaced this way also. Take care not to mis-align and thereby possibly bend the tube pins or injure the socket while inserting them.

3. After verifying that all 17 tubes are installed in their proper sockets and are fully and properly seated, reinstall the cage. You may now proceed with INSTALLATION and OPERATING INSTRUCTIONS.

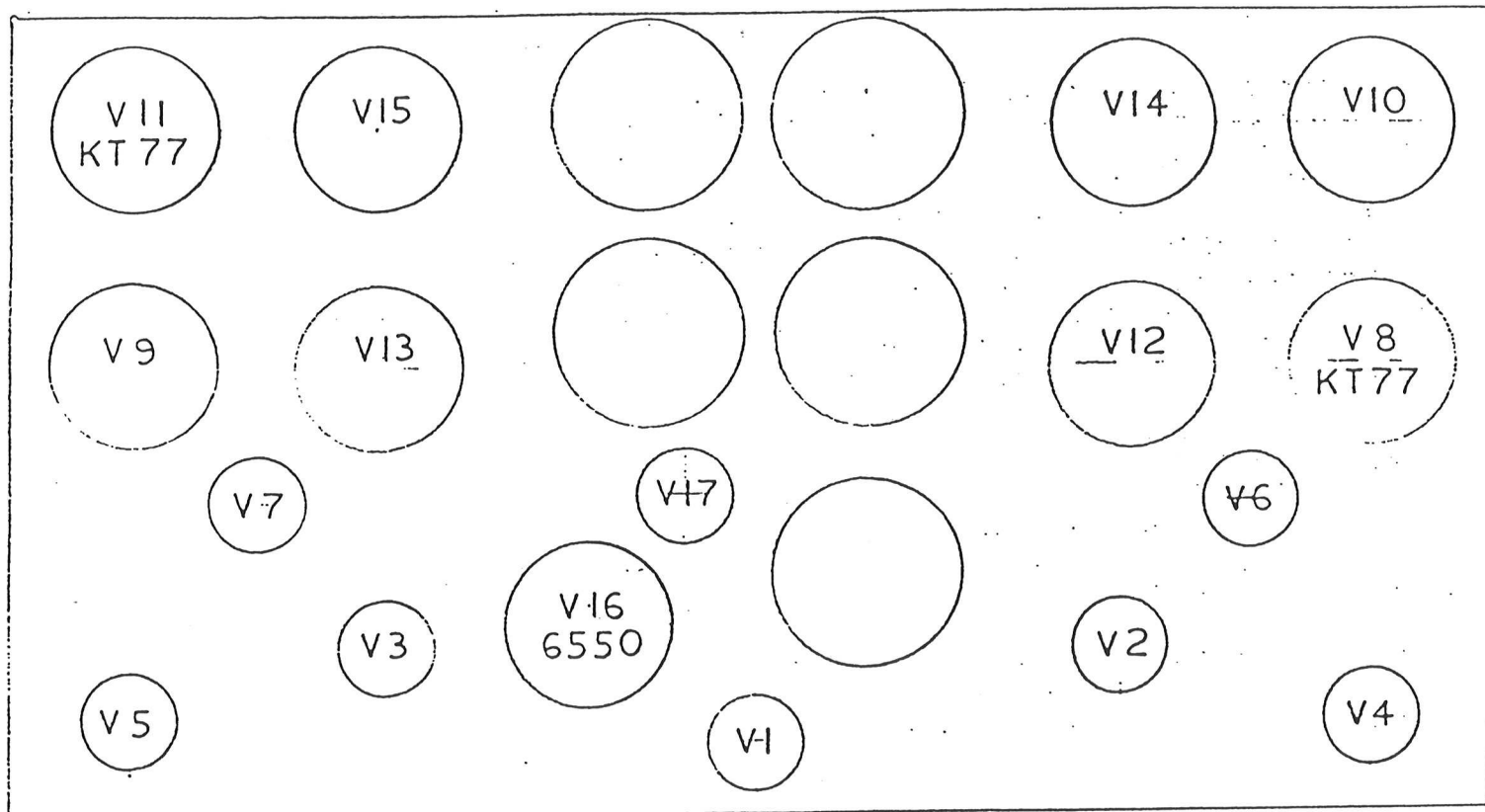

VACUUM TUBE LOCATIONS D115 AMPLIFIER

| | |
|-------|------------|
| V1-7 | 6DJ8/ECC88 |
| V8-15 | KT77 (4MP) |
| V16 | 6550 |
| V17 | 12AT7 |

INSTALLATION

To insure normal component life and safe operation this unit must be operated only in a horizontal position. Adequate air flow and proper cooling thereby can occur only if there is no restriction below, behind and above the unit.

The special non-marring elastomer feet provide adequate spacing only from a smooth, hard surface. Never operate the unit while it is sitting on a surface such as a rug or carpet.

If the unit is to be operated in an enclosure such as an equipment rack, make certain that adequate air flow above and below the unit is provided. The "ambient" operating temperature should never exceed 120°F or 49°C. Audio Research Corporation Rack Mount Ventilators (RMV-3) must be used above and below each unit. Improper installation will cause premature tube failure and will affect your warranty, as well as the service life of the unit.

It is normal for a vacuum tube power amplifier to run "warm," and if used for prolonged periods, "hot" to the touch. All components within are, however, operated at safe, conservative levels and will not be improperly affected thereby, providing the requirements outlined above are adhered to.

CONNECTION INSTRUCTIONS

The front panel has:

- 1 Switch - AC power "On-Off"
- 2 Fuse Holders - 1 power line, 1 screen
- 2 Indicators - 1 power line "On," 1 screen power "On" (These indicators also serve as fuse-out indicators)

The rear panel has:

- 2 Input level control knobs
- 2 Input connectors
- 2 Output connection terminal barrier blocks
- 1 Power line cord

To place the unit in operation the following procedure is recommended:

1. Connect your speakers using the best available speaker wires. We cannot emphasize this enough. It has been determined that the better the component system the more important it becomes to use the very best interconnect and speaker wires.

Note that the D115 is a "non-inverting" amplifier. It is important, sonically, that your entire system be connected so that the audio signal arriving at the speaker be "non-inverting."

2. Wire the left speaker "0" or "-" connection to the left "0" amplifier terminal. Wire the speaker "+" or otherwise identified (such as "4," "8," "16," "hot") positive terminal to the "4," "8" or "16" ohm amplifier terminal as required. Repeat this procedure with the right speaker and amplifier right channel connections.

NOTE: It is important to use as close as possible an impedance match between amplifier and speaker so as to allow optimum transfer of power to the speaker while preserving minimum distortion operation of the amplifier. In the case of some complex speaker systems, including electrostatic types, the best impedance match should be determined empirically.

3. CAUTION: The outputs of your D115 amplifier, like all ARC tube amplifiers, are "balanced" outputs. This is so because of the nature of our partially cathode-coupled output stage and overall balanced design. Since the output terminations are marked in "impedance" (ie: "4," "8" and "16" ohms), and since the center taps of the output windings must be grounded:

$$\frac{\sqrt{Z1}}{\sqrt{Z2}} = \frac{T1}{T2} \quad \text{OR} \quad \frac{\sqrt{4}}{\sqrt{16}} = \frac{2}{4}$$

the "4" ohm taps are grounded, being the center tap. This is unimportant in actual use except to be aware of the following possible situations:

a) Headphone speaker switching devices. Many of these units have a "common ground." This, of course, will connect the two amplifier "0" terminals together. Since the "4" ohm terminals are already connected together internally (remember, they are the common grounded center tap) you now have strapped the two amplifier sections together and created a modified monaural amplifier. Inevitably, these headphone speaker switching devices are also not satisfactory sonically in systems of a quality justifying the use of a D115 amplifier. Our recommendation is not to use them at all. If one "must" be used, contact Customer Service at ARC for instructions.

b) Some complex loudspeaker systems with integral power supply/crossover networks can have a common ground system, possibly also with grounding through the power line, just as the D115 amplifier does. If a "ground lifter" adaptor plug is not used, the result is that the amplifier is called upon to drive a virtual short circuit in addition to the problem listed in a) above. If your speaker system employs a power line connected power supply/crossover network and you experience either "monaural" sound and/or extremely weak and distorted sound, contact Customer Service or Engineering at ARC for instructions concerning your specific speaker.

4. Connect the amplifier to the preamplifier or electronic crossover, using only the highest grade audio interconnect cables.

5. Place the power on-off switch in the "off" position and connect the power line cord to the AC power, observing Paragraph 2 under USE CAUTIONS, Page 2 of this manual.

IT IS DESIRABLE THAT THE D115 AMPLIFIER BE CONNECTED DIRECTLY TO A POWER RECEPTACLE. IT SHOULD NOT BE CONNECTED TO CONVENIENCE RECEPTACLES ON PRE-AMPLIFIERS, ETC. THE POWER SOURCE USED MUST BE CAPABLE OF PROVIDING UP TO 10 AMPERES FOR 100/120 VOLT UNITS AND UP TO 6 AMPERES FOR 240 VOLT UNITS.

CAUTION: Make certain the amplifier is installed according to the instructions under INSTALLATION on Page 5 of this manual. Contact your dealer for help if you have any questions on the above procedure.

OPERATING INSTRUCTIONS

1. Make sure that you have complied with the INSTALLATION and CONNECTION INSTRUCTIONS prior to attempting operation.
2. The preamplifier should be on and initially muted and/or at minimum gain.
3. Turn the D115 power switch "On." You will note a short delay of approximately 1/2 second before the power relay clicks in and the "On" (and fuse out) indicator lamp reaches full brilliance. This "soft start" protection is provided to minimize the power surge of charging the D115 capacitors, to prolong component life and minimize the momentary "light dimming" encountered when switching on audio power amplifiers. The duration of this turn-on delay will vary with line voltage.
4. After about 10-30 seconds the "screen" lamp will also light, indicating that the high voltage regulators have reached operating temperature.
5. The D115 will now operate satisfactorily. However, a full stabilization time of 15 to 30 minutes is recommended for best sonic performance.

NOTE: It is important to note here that ARC does not recommend operation of the unit 24-hours a day. (As is the custom of some audiophiles to achieve maximum sonic performance.) While this is probably good procedure for solid-state equipment, ARC does NOT recommend this for vacuum tube equipment. Vacuum tube life is shortened significantly by this procedure.

6. Input level controls. The input level controls may be used to "balance" the levels between amplifiers of different input sensitivity when using the D115 in a bi-amplified system.

If used alone in a single amplifier system, the input level controls should be adjusted to provide a normal listening level when the gain control on the pre-amplifier control unit is in the range of 10 to 2 o'clock. This adjustment will provide optimum control by your preamplifier, as well as providing best signal-to-noise ratio therefrom.

ADJUSTMENT PROCEDURE AND DISCUSSION

The D115 utilizes very high quality, commercial and computer grade components and this, together with conservative operation of all components and tubes, will provide long service life, if installed and operated within the parameters outlined in this manual.

The output tubes, for example, are operated with electronically regulated "bias" as well as electronically regulated "screen" voltage. With these voltages regulated the variation in output tube idle current for varying line voltage becomes normally unimportant.

The output tubes are set at the factory for an "idle" cathode current of 65mA. (.065 amperes) each at a power line voltage of 120. Reducing the line voltage to 105 causes this current to drop to 62/63mA. Increasing the line voltage to 130 causes this current to increase to 67/68mA. This amount of change is not important sonically nor will it materially affect tube life.

After vacuum tube failure and replacement, it is important to readjust the amplifier for optimum performance and tube life.

CAUTION: The following internal procedures should not be attempted by the owner unless he is technically qualified. There are high voltages and currents within this unit which can be lethal under certain conditions. All internal adjustments should be accomplished by a qualified individual. It is necessary to remove the top cage from the D115 for the following adjustments. Unit should be off for cage removal.

There are three (3) parameters which may be adjusted (in the following sequence) in the D115. These adjustments are internal, requiring removal of the cage. Use the plastic alignment tool provided:

1. OUTPUT TUBE IDLE CURRENT ("BIAS")
2. DC BALANCE
3. AC BALANCE

1. OUTPUT TUBE IDLE CURRENT ("BIAS")

The output stages of the D115 are partially cathode-coupled "push-pull Class AB₁," utilizing our tightly-coupled output transformers which provide low distortion and sonic accuracy.

As shipped from the factory, the output "bias" adjustments are set for a nominal 65mA. per tube with a stable power line voltage of 120. (Export models are adjusted for each country's requirements.) Under these conditions the tubes are each dissipating approximately 28 watts of their 38 watt rating (32 watt plate, 6 watt screen). This point of operation provides "enriched" Class AB₁, and will satisfy most critical listeners.

Although the main "B+" voltage to the output tubes will vary with line voltage, the "bias" voltage and the "screen" voltage are electronically regulated. Because of this the change in operating point of the output stage does not vary significantly with reasonable changes in line voltage. It is therefore not normally necessary to readjust "bias" except when changing power output tubes.

Make sure that ventilation requirements are met as described under INSTALLATION to prolong tube and other component life.

1A. "BIAS" ADJUSTMENT PROCEDURE

For best results operate and adjust the D115 at 120VAC line voltage, or at the line voltage that is typical in the final installation. Adjustment should be made under zero-signal conditions after at least 15-20 minutes of uninterrupted stabilization time. There may be a very slight interaction between the 8 output tube bias adjustments, so recheck the first tube current after adjusting the other 7, etc., until you are certain that all are correct and stabilized.

A digital voltmeter capable of accurate measurements in the range of .05 to .1 Volt DC is required to accomplish this adjustment (must have 3 1/2 digit display.) Use the plastic alignment tool provided to make the adjustments.

There is a 1 ohm 5% wirewound resistor in the cathode circuit of each output tube, and these connections (test points referred to schematically and on the circuit board as TPs) are provided at either end of these resistors so that a voltage measurement can be conveniently made across each resistor. These test points are identified and accessible from the top side of the printed wiring board.

Because the resistor is 1 ohm, you can conveniently "direct" read the total cathode current in each tube. A .065 Volt reading indicates 65mA. (Be certain that you do NOT attempt to read current.)

| <u>TUBE</u> | <u>TEST POINTS</u> | <u>ADJUSTMENT</u> |
|-------------|--------------------|-------------------|
| V8 | TP8, TP5 | RV8 |
| V10 | TP10, TP5 | RV10 |
| V12 | TP12, TP7 | RV12 |
| V14 | TP14, TP7 | RV14 |
| V9 | TP9, TP6 | RV9 |
| V11 | TP11, TP6 | RV11 |
| V13 | TP13, TP16 | RV13 |
| V15 | TP15, TP16 | RV15 |

It is important that all 8 output tubes be reasonably matched (within 5%) for highest performance operation. (Matched sets are available from Audio Research.) It is also important, both for long life free from arcing effects as well as sonically, that these tubes be of a low "gas" nature. Tubes provided by Audio Research will meet these parameters.

2. DC BALANCE

The D115 uses an improved version of our patented cross-coupled input/driver circuit that automatically tracks normal minor tube drift. Therefore, the accuracy of DC balance required for best performance is not super-critical. However, it is necessary to check and reset DC balance if input tubes V2 or V3 are changed.

A battery-operated digital voltmeter having a 10 megohm or higher input impedance and 3 1/2 digit resolution or better is needed for this adjustment.

Set each adjustment for +95V^{*} DC within 0.1V of equal voltages for the two test points of each channel. Allow at least 20-30 minutes warmup stabilization for best results, plus 10-20 hours "burn-in" for the new tubes.

* +75V DC MKII

The sonic or measured degredation is minimal with up to 2 volts of DC unbalance, but it is best to set the balance with 0.1V to allow for tube aging.

| | <u>TUBE</u> | <u>TEST POINT</u> | <u>ADJUSTMENT</u> | <u>SET TO</u> |
|-----------|-------------|-------------------|-------------------|-----------------------------------|
| Channel 1 | V2 | TP1 TP3 | RV1 RV3 | +95V DC) 0.1 Matched +95V -DC) |
| Channel 2 | V3 | TP2 TP4 | RV2 RV4 | +95V DC) 0.1 Matched +95V DC) |

If proper voltages cannot be achieved, replace the tube indicated above.

3. AC BALANCE

Normally the AC balance does not require readjustment. If tubes are changed, however, you may want to recheck its setting. This adjustment should not be attempted unless low distortion measuring equipment is available.

First, make sure the output tubes are properly biased and that the DC balances are correct.

Using the plastic alignment tool provided, set RV5 and RV6 for minimum second harmonic distortion at 1 watt of 1 kHz output into a 16 ohm load, typically less than .005%. As an approximation, the adjustments can be made for minimum 1kHz total harmonic distortion and noise, typically less than .02%.

A properly adjusted unit will achieve AC balance at about midrotation $\pm 30^\circ$ of RV5 and RV6. If lowest distortion requires adjusting beyond this range, it may indicate a weak or unbalanced tube at V2 or V3 or possibly other tubes.

WARRANTY TERMS

This unit is offered for sale with a LIMITED Warranty as set forth below:

1. Warranty. Audio Research warrants the product designated herein to be free of manufacturing defects in material and workmanship, subject to the conditions set forth herein, for a period of 90 days from the date of purchase by the original purchaser, provided it is purchased within two (2) years of the date of manufacture of the unit.

To obtain this warranty, proof of purchase (photocopy of bill of sale by an authorized Audio Research dealer) must be submitted with the unit for any repairs under the terms and conditions herein set forth.

2. Conditions. This Warranty is subject to the following conditions and limitations. The Warranty is void and inapplicable if the product has been used or handled other than in accordance with the instructions in the owner's manual, abused or misused, damaged by accident or neglect or in being transported, or the defect is due to the product being repaired or tampered with by anyone other than Audio Research or an authorized Audio Research repair center. The product must be packed and returned to Audio Research (or a repair center authorized by Audio Research) by the customer at his or her sole expense. A RETURNED PRODUCT MUST BE ACCOMPANIED BY A WRITTEN DESCRIPTION OF THE DEFECT AND A PHOTOCOPY OF THE BILL OF SALE. Audio Research reserves the right to modify the design of any product without obligation to purchasers of previously manufactured products and to change the prices or specifications of product without notice or obligation to any person

3. Remedy. In the event the above product fails to meet the above Warranty and the above conditions have been met, the purchaser's sole remedy shall be to return the product to Audio Research or an authorized Audio Research repair center where the defect will be rectified without charge for parts or labor, except vacuum tubes (see 6 below).

4. Limited to Original Purchaser. This Warranty is for the sole benefit of the original purchaser of the covered product and shall not be transferred to a subsequent purchaser of the product.

5. Duration of Warranty. This Warranty is for a period of 90 days from date of purchase from an authorized Audio Research dealer.

6. Vacuum Tubes. Vacuum tubes and replacement thereof are warranted only for the original 90-day Warranty period.

7. Miscellaneous. ANY IMPLIED WARRANTIES RELATING TO THE ABOVE PRODUCT SHALL BE LIMITED TO THE DURATION OF THIS WARRANTY. THE WARRANTY DOES NOT EXTEND TO ANY INCIDENTAL OR CONSEQUENTIAL COSTS OR DAMAGES TO THE PURCHASER. Some states do not allow limitations on how long an implied warranty lasts or an exclusion or limitation of incidental or consequential damages, so the above limitations or exclusions may not apply to you. This Warranty gives you specific legal rights, and you may also have other rights which vary from state to state.

WARRANTY EXTENSION TERMS

Because Audio Research wants each unit to be "registered" at the factory for various reasons, an extension of the Limited Warranty to 3 years from date of purchase (by the original purchaser and provided it is purchased within two (2) years of the date of manufacture of the unit) is offered in exchange for registration of your unit. Appropriate forms are attached to each product carton to accomplish this. Please note the following in regard to this:

1. Registration must be postmarked within 30 days from the date of purchase from an authorized Audio Research dealer. Exceptions to this will not be made.
2. Vacuum tubes are NOT included in this Warranty Extension offer.
3. All other terms and conditions as set forth in the WARRANTY TERMS apply.
4. Please read the WARRANTY REGISTRATION CAUTION as set forth on Page 1 of this manual.

D115 TENTATIVE SPECIFICATIONS (AC line set @120V 60Hz for these specifications)

Power Output:

100 watts per channel minimum continuous (both channels operating) at 16 ohms from 20Hz to 20kHz with less than 1% total harmonic distortion (typically below .005% at 1 watt)

Approximate actual power available per

channel at "clipping" (both CH. OP, 1kHz): 115 Watts

(Note that actual RMS power output is dependent upon both line voltage and "condition" ie: if power line has high distortion, maximum power will be affected adversely, although from a listening standpoint this is not very critical.)

Power Bandwidth:

(-3dB Points) 10Hz to 60kHz

Intermodulation Distortion:

Less than .1% at 1dB below rated output (100V p to p, 16 ohms - SMPTE method)

Input Sensitivity:

1.2V RMS for rated output

Input Impedance:

75K ohms, nominal

Output Regulation:

Approximately .4dB, 16 ohm load to open circuit
(Damping factor approximately 20)

Negative Feedback:

20dB

Slew Rate:

15 volts/microsecond

Rise Time:

5 microseconds

Hum & Noise:

90dB below rated output -- less than 2mV RMS -- (Broad-bandwidth unweighted, inputs shorted)

Power Supply Energy Storage:

Approximately 280 joules

Power Requirements:

105-125VAC 60Hz (210-250VAC 50Hz) 1000 watts maximum

400 watts at "idle"

Dimensions:

19" (48 cm) W (standard rack panel) x 7" (18 cm) H x 16.5" (42 cm) D (front panel back). Handles extend 1 5/8" (4.1 cm) forward of the front panel.

Weight:

68 lbs. (31 kg) Net; 84 lbs. (38 kg) Shipping

Tubes Required:

| | |
|---------------------------------|------------------|
| 4 - Matched Pair KT77 (low gas) | Power Output |
| 1 - 6550 (low gas) | Regulator |
| 1 - 12AT7 | Regulator Driver |
| 7 - 6DJ8 (ECC88) | Small Signal |

D-115 POWER AMPLIFIER

SCHEMATIC

9-9-83

audio research corporation

6801 SHINGLE CREEK PARKWAY
MINNEAPOLIS, MINNESOTA 55430

9/6/63/8
D115
P1 of 3

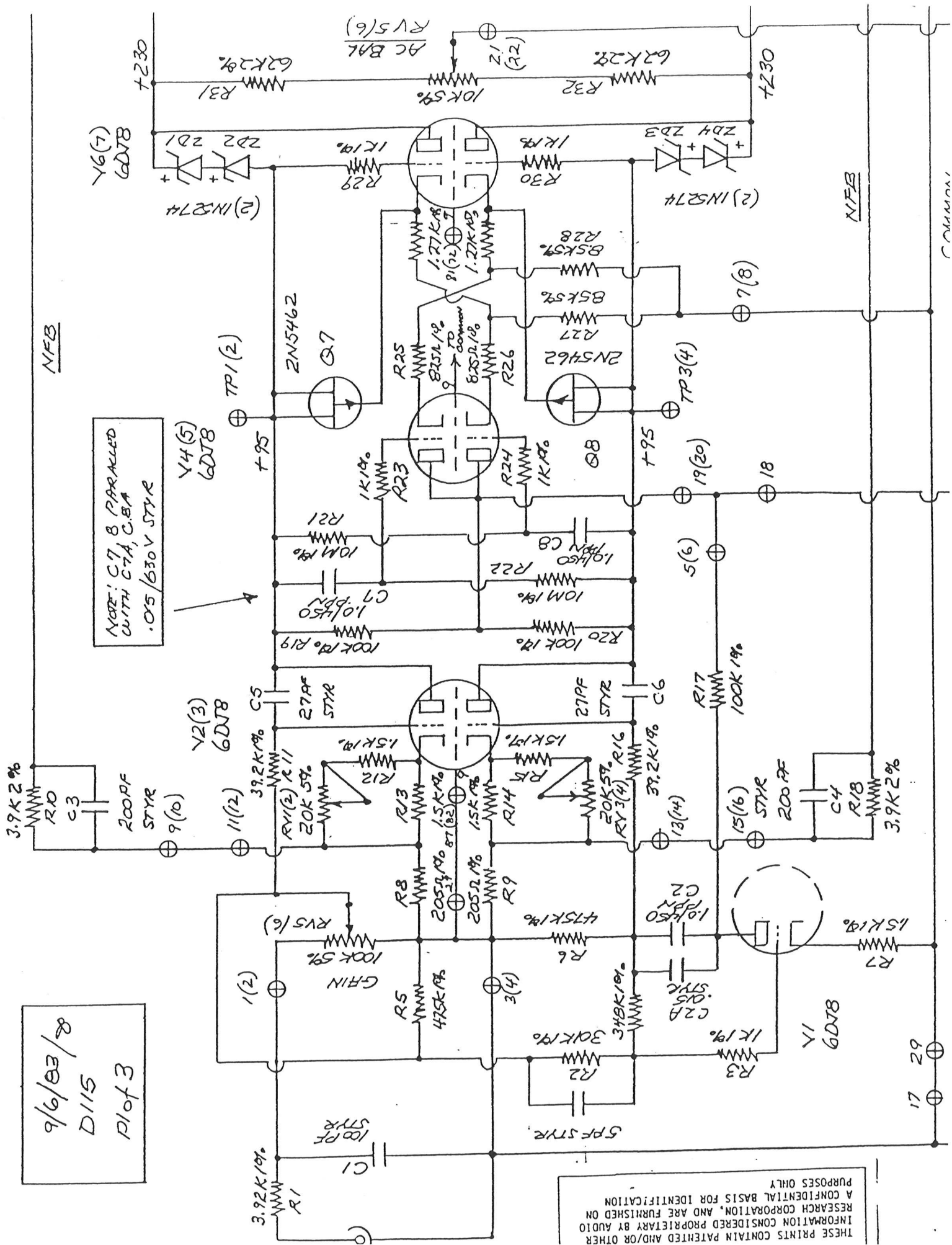

NOTE: C7, 8 PARALLELED WITH C7A, C8A .005/630V STYR

THESE PRINTS CONTAIN PATENTED AND/OR OTHER INFORMATION CONSIDERED PROPRIETARY BY AUDIO RESEARCH CORPORATION, AND ARE FURNISHED ON A CONFIDENTIAL BASIS FOR IDENTIFICATION PURPOSES ONLY

NFB

V8-15
4-MP K777

.055M μ R

1.0/450
D9N
1.0/450
D9N

184K1%
RV8(9)

20K5%
RV10(11)

184K1%
RV14(15)

184K1%
RV12(13)

1.0/450
D9N

1.0/450
D9N

.055M μ R

.055M μ R

NFB

COMMON

V8(9)

5% 1.25%
1.25%

4712.5%
TP8(9)

1.25%
TP5(6)

1.25%
TP10(11)

1.25%
TP7(16)

1.25%
TP14(15)

4712.5%
TP2(13)

4712.5%
TP1(12)

1.25%
V12(13)

1.25%
V14(15)

38

V10(11)

5% 1.25%
1.25%

4712.5%
TP5(6)

1.25%
TP10(11)

1.25%
TP7(16)

1.25%
TP14(15)

4712.5%
TP2(13)

4712.5%
TP1(12)

1.25%
V12(13)

1.25%
V14(15)

32

23

30

(+)

(+)

16

8

4

0

D115 AMPLIFIER
9/16/83
8 PAGE 2 of 3

PRIORITY NOTICE

THESE PRINTS CONTAIN PATENTED AND/OR OTHER INFORMATION CONSIDERED PROPRIETARY BY AUDIO RESEARCH CORPORATION, AND ARE FURNISHED ON A CONFIDENTIAL BASIS FOR IDENTIFICATION PURPOSES ONLY

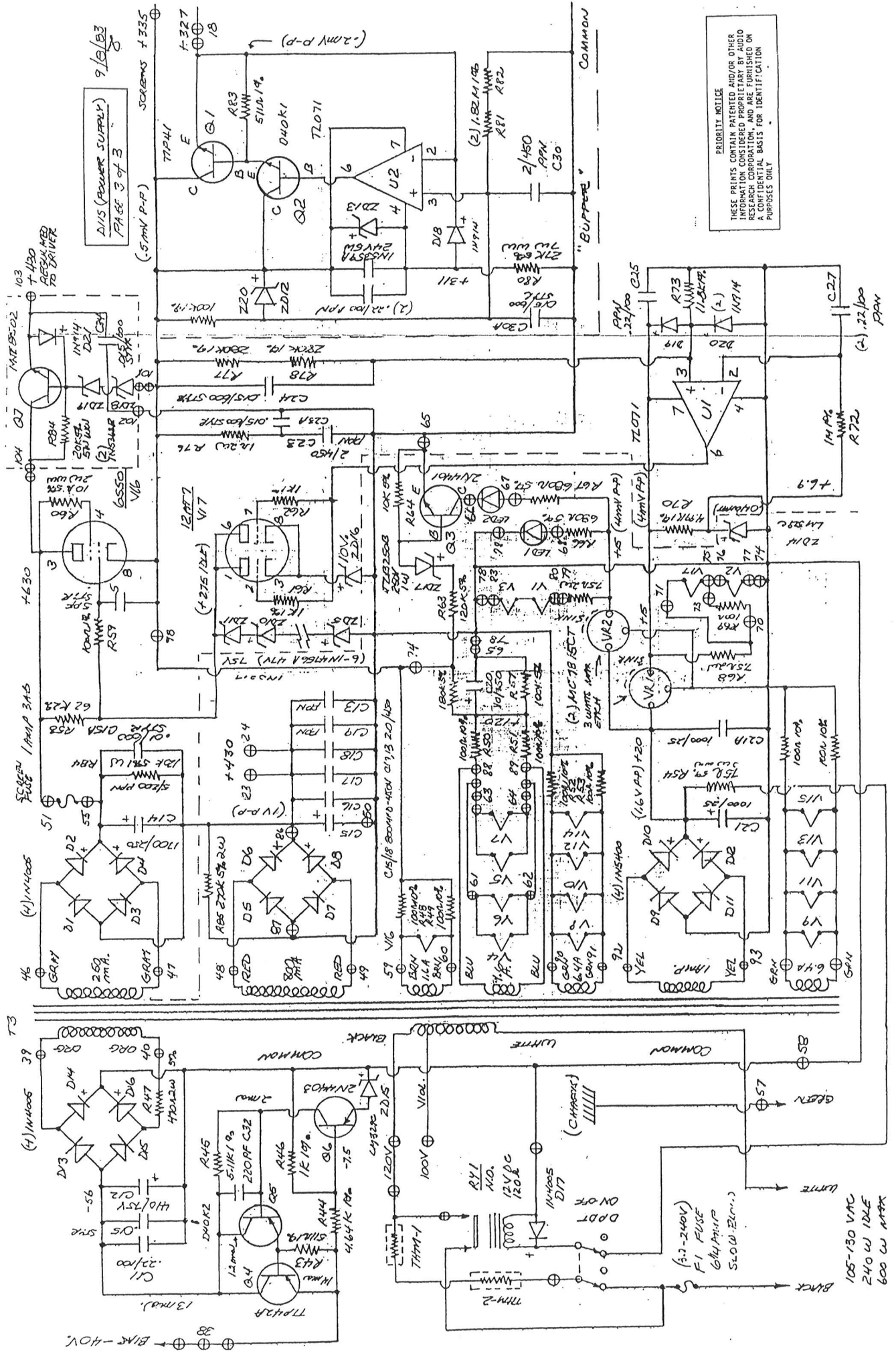

PRIORITY NOTICE
 THESE PRINTS CONTAIN PATENTED AND/OR OTHER
 INFORMATION, CONSIDERED PROPRIETARY BY AUDIO
 RESEARCH CORPORATION, AND ARE FURNISHED ON
 A CONFIDENTIAL BASIS FOR IDENTIFICATION
 PURPOSES ONLY

9/8/83
 D1/5 (POWER SUPPLY)
 PHASE 3 OF 3

SCHEM 1 AMP 3A5

SCHEM 2 DRIVER

SCHEM 3

SCHEM 4

SCHEM 5

SCHEM 6

SCHEM 7

SCHEM 8

SCHEM 9

SCHEM 10

SCHEM 11

SCHEM 12

SCHEM 13

SCHEM 14

SCHEM 15

SCHEM 16

SCHEM 17

SCHEM 18

SCHEM 19

SCHEM 20

SCHEM 21

SCHEM 22

SCHEM 23

SCHEM 24

SCHEM 25

SCHEM 26

SCHEM 27

SCHEM 28

SCHEM 29

SCHEM 30

SCHEM 31

SCHEM 32

SCHEM 33

SCHEM 34

SCHEM 35

SCHEM 36

SCHEM 37

SCHEM 38

SCHEM 39

SCHEM 40

SCHEM 41

SCHEM 42

SCHEM 43

SCHEM 44

SCHEM 45

SCHEM 46

SCHEM 47

SCHEM 48

SCHEM 49

SCHEM 50

SCHEM 51

SCHEM 52

SCHEM 53

SCHEM 54

SCHEM 55

SCHEM 56

SCHEM 57

SCHEM 58

SCHEM 59

SCHEM 60

SCHEM 61

SCHEM 62

SCHEM 63

SCHEM 64

SCHEM 65

SCHEM 66

SCHEM 67

SCHEM 68

SCHEM 69

SCHEM 70

SCHEM 71

SCHEM 72

SCHEM 73

SCHEM 74

SCHEM 75

SCHEM 76

SCHEM 77

SCHEM 78

SCHEM 79

SCHEM 80

SCHEM 81

SCHEM 82

SCHEM 83

SCHEM 84

SCHEM 85

SCHEM 86

SCHEM 87

SCHEM 88

SCHEM 89

SCHEM 90

SCHEM 91

SCHEM 92

SCHEM 93

SCHEM 94

SCHEM 95

SCHEM 96

SCHEM 97

SCHEM 98

SCHEM 99

SCHEM 100

105-130 VAC
 240 W IDLE
 600 W MAX

NFB

V8-15
4-MP K777

.055M Ω R

(+)

1.0/450
P2X

1.0/450
P2X

.055M Ω R

.055M Ω R

.055M Ω R

1.0/450
P2X

1.0/450
P2X

.055M Ω R

.055M Ω R

.055M Ω R

NFB

COMMON

(-) V8(9)

1.25%
1.25%
1.25%

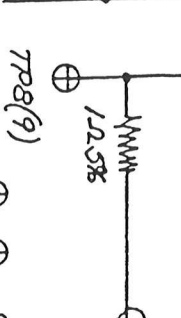
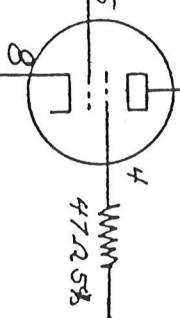

TP12(13)

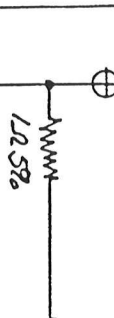

(LEFT ONLY)
T1 T1

V10(11)

1.25%
1.25%
1.25%

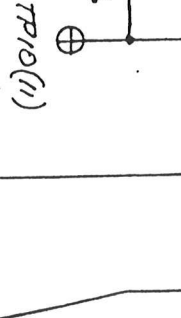
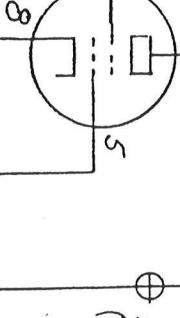

TP7(16) TP14(15)

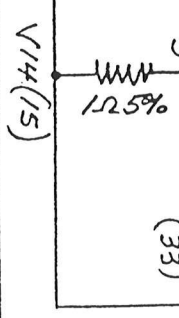
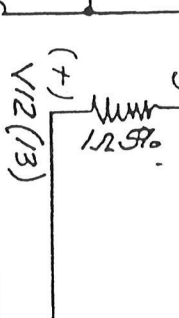
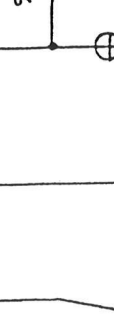

(31)

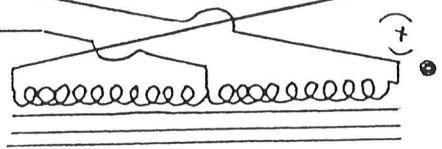

(+)

23 (24)

3% (37)

(+)

16

8

4

0

D115 AMPLIFIER
9/6/83
8 PAGE 2 of 3

PRIORITY NOTICE

THESE PRINTS CONTAIN PATENTED AND/OR OTHER INFORMATION CONSIDERED PROPRIETARY BY AUDIO RESEARCH CORPORATION, AND ARE FURNISHED ON A CONFIDENTIAL BASIS FOR IDENTIFICATION PURPOSES ONLY