

HEAVY DUTY COOKING**VULCAN****ARS SERIES
SELF-CONTAINED REFRIGERATED BASES****Model ARS72**

(Shown with optional right-located compressor with
ASA griddle, ACB charbroiler and AHP hotplate)



UL listed to U.S. and Canadian safety standards. NSF listed.

SPECIFICATIONS

Heliarc welded, fully insulated, stainless steel double pan Cabinet exterior front, sides, louver assembly and drawers are constructed of 20-gauge 430 stainless steel, exterior back and bottom are constructed of heavy gauge galvanized steel. Cabinet interior sides are constructed of 22-gauge 400 series stainless steel, top and bottom are constructed of 22-gauge 300 series stainless steel. A set of 4" high casters are included standard. Vinyl magnetic snap-in drawer gasket assures tight drawer seal. Both the cabinet and drawers are insulated with an average of 2" thick high density, non-CFC, foamed in place polyurethane. The easy to use water resistant INTELA-TRAUL® microprocessor control system is supplied standard. Unit is NAFEM Data Protocol communication (NDP) ready. Optional hardware required to be NDP compliant (3rd party software required for network connection). It includes a 3-Digit LED Display, °F or °C Temperature Scale Display Capability, and an RS485 data port. In addition it includes audio/visual alarms for: Hi/Lo Cabinet Temperature, Clean Condenser, Evaporator Coil and Discharge Line Sensor Failures, and Power Supply Interruption. The left side mounted, self-contained, balanced refrigeration system using R-404A refrigerant features an off-cycle defrost, capillary tube, air-cooled hermetic compressor, automatic condensate evaporator, and a dedicated rear-mounted evaporator design which distributes cold air through

- ARS36** 36" wide
- ARS48** 48" wide
- ARS60** 60" wide
- ARS72** 72" wide
- ARS84** 84" wide
- ARS96** 96" wide
- ARS110** 110" wide

STANDARD FEATURES

- Stainless steel top, front, sides and interior
- Marine edge top
- Compressor on left
- 4" casters in adjustable channels
- INTELA-TRAUL microprocessor control system
- Balanced, self-contained refrigeration system that utilizes R-404A
- Front-breathing design allows for zero clearance installation
- Controllable anti-condensate drawer perimeter heaters
- Automatic non-electric condensate filter
- Condenser filter
- Off-cycle evaporator defrost
- Magnetic snap-in drawer gaskets
- Self-closing drawers with stay open feature
- Side, front and rear access panels provide for ease of service and maintenance
- 14-gauge stainless steel drawer slides
- NEMA 5-15 plug with 9' cord and cord retainer
- One year limited parts and labor warranty

OPTIONS

- 6" stainless steel legs
- Compressor on right
- 6" cabinet length extension
- Export 220/50/1 voltage
- NAFEM data protocol gateway package

each drawer section. A 9' cord and retainer is provided. Standard operating temperature is 34 to 38°F. Each heavy-duty drawer is designed to accommodate 12" x 20" x 6" deep pans. They are constructed using 14-gauge stainless steel drawer slides and 2" diameter stainless steel rollers. Drawers include both a self-closing and stay-open feature.

Exterior Dimensions:

____"w x 34"d x 26"h on 4" casters

VULCAN

a division of ITW Food Equipment Group LLC

P.O. Box 696 ■ Louisville, KY 40201 ■ Toll-free: 1-800-814-2028 ■ Local: 502-778-2791 ■ Quote & Order Fax: 1-800-444-0602



ARS SERIES
SELF-CONTAINED REFRIGERATED BASES

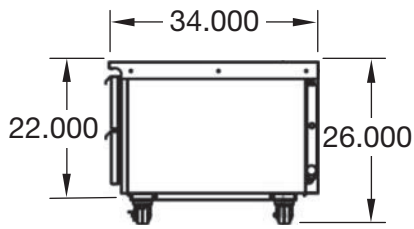

SIDE VIEW ALL MODELS

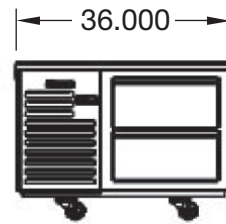
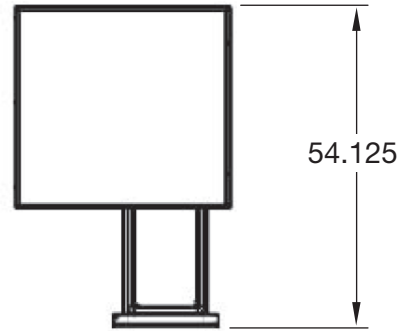

ARS36

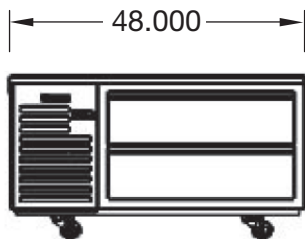
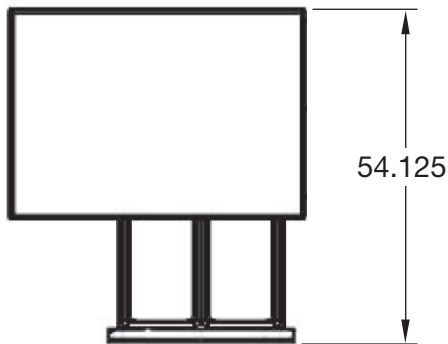

ARS48

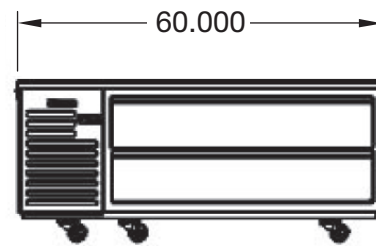
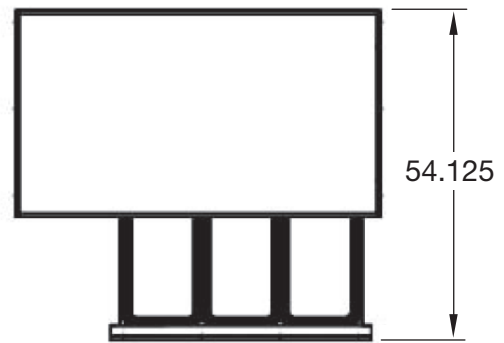

ARS60



a division of ITW Food Equipment Group LLC

HEAVY DUTY COOKING



**ARS SERIES
SELF-CONTAINED REFRIGERATED BASES**

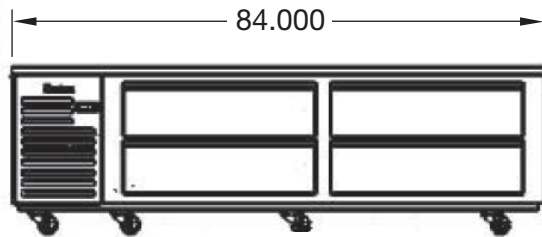
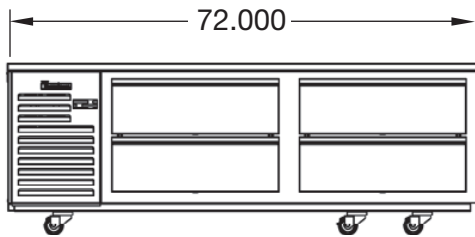
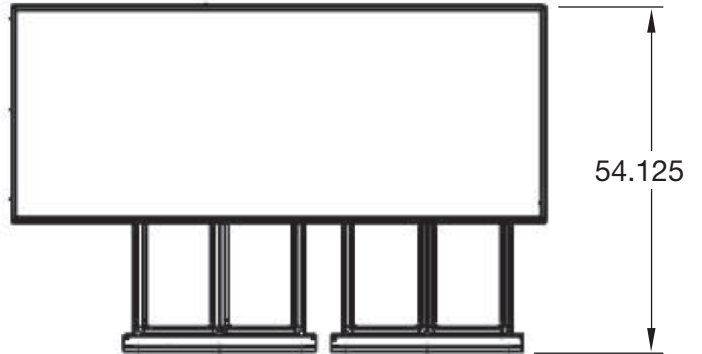
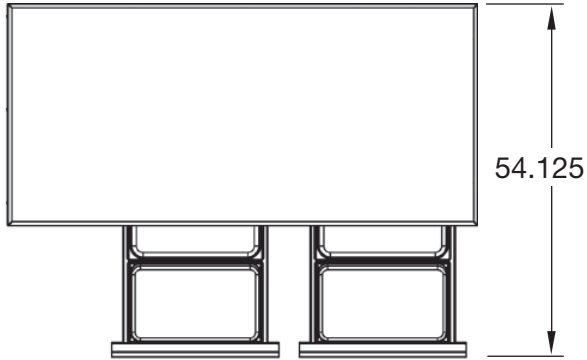

ARS72

ARS84

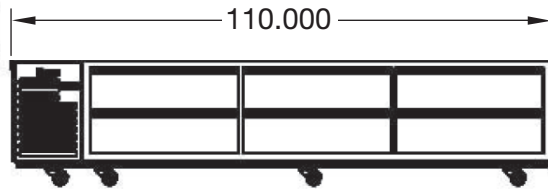
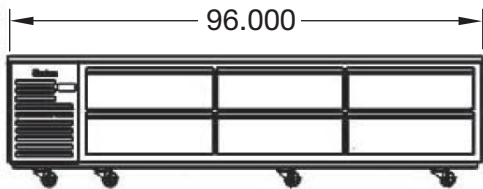
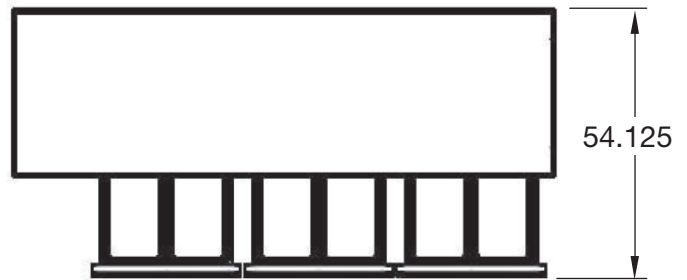
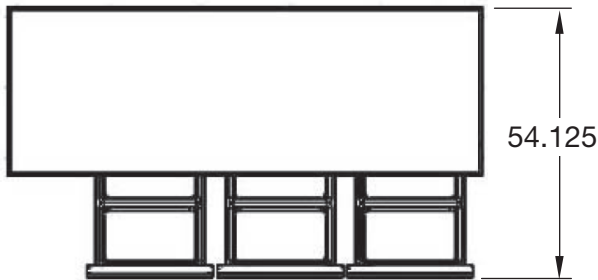

ARS96

ARS110



a division of ITW Food Equipment Group LLC

P.O. Box 696 ■ Louisville, KY 40201 ■ Toll-free: 1-800-814-2028 ■ Local: 502-778-2791 ■ Quote & Order Fax: 1-800-444-0602



ARS SERIES
SELF-CONTAINED REFRIGERATED BASES

MODEL	BTU/HR-HP ²	REFRIG.	VOLT/HZ/PH	FULL LOAD AMPS	NEMA PLUG TYPE	MAX. TOP LOAD	PAN ORIENTATION
ARS36	2,440 (1/3 HP)	R-404A	115/60/1	6.7	5-15P	625 lbs.	N/A
ARS48	2,440 (1/3 HP)			6.7		625 lbs.	Side by Side
ARS60	2,440 (1/3 HP)			6.7		625 lbs.	Side by Side
ARS72	2,440 (1/3 HP)			6.7		1,200 lbs.	Front to Back
ARS84	2,440 (1/3 HP)			6.7		1,500 lbs.	Side by Side
ARS96	4,090 (1/2 HP)			12		1,500 lbs.	Front to Back
ARS110	4,090 (1/2 HP)			12		1,500 lbs.	Side by Side

MODEL	COUNTER DEPTH	COUNTER HEIGHT	COUNTER WIDTH	DEPTH W/OPEN DRAWER	NO. OF DRAWERS	PAN CAPACITY 12" x 20" x 6"	APPROX. SHIP WEIGHT	
							LBS	KG
ARS36	34" (914)	26" (660)	36" (914)	54 1/8" (1,375)	2	2	410	186
ARS48			48" (1,219)		2	4	430	195
ARS60			60" (1,524)		2	6	475	216
ARS72			72" (1,829)		4	8	555	252
ARS84			84" (2,134)		4	8	655	297
ARS96			96" (2,438)		6	12	760	345
ARS110			110" (2,794)		6	12	845	383

Dimensions in () are in millimeters



a division of ITW Food Equipment Group LLC

P.O. Box 696 ■ Louisville, KY 40201 ■ Toll-free: 1-800-814-2028 ■ Local: 502-778-2791 ■ Quote & Order Fax: 1-800-444-0602

NOTE: In line with its policy to continually improve its products, Vulcan reserves the right to change materials and specifications without notice.