



Project _____
 Item # _____
 Quantity _____

Thermo-Finisher® Food Finishers

Models: TF-1919, -4619, -461R
 TFW-461R
 TFWM36-3900, -3939
 TFWM42-3900, -3939

The Hatco Thermo-Finisher® is designed to rapidly heat or thermalize a range of food products which allows operators to serve customers faster, thereby improving customer satisfaction. The Thermo-Finisher is perfect for melting toppings or finishing soup and foods like Mexican entrees, nachos and potato skins, as well as toasting buns and breads. It also thermalizes frozen foods such as appetizers, french fries and pizza. The Thermo-Finisher can also be used to heat plates prior to serving.

Standard features

- The NEW TFWM36 models are 6.37" (162 mm) shorter in width, to accommodate smaller spaces
- The high efficiency allows the operator to thermalize and complete entrees in less than half the time of conventional methods
- Standby mode saves energy, and the exclusive Instant-On feature assures the unit is ready to use, with no warm-up time needed
- TFWM models feature three bays with on demand plate activated technology with adjustable heat intensity
- TFWM models: removable bay dividers allow you to accomodate wider dishes
- Kitchen staff can be assured of consistent product preparation with up to five preprogrammed recipe times
- Stainless steel interior and heavy-duty glass surfaces cover the heat source making it durable and easy to clean



TFW-461R



TF-4619
 with accessory pan



TFWM42-3900
 with removable
 stainless steel
 dividers

Options (available at time of purchase only)

Designer Color Side Panels (TF and TFW models only)
 Non-standard colors are non-returnable – Black standard
 Warm Red

Designer Color Side Panels (TFWM models only)
 Non-standard colors are non-returnable – Warm Red standard
 Black Stainless Steel

Cord and Plug (TFWM42-3900 Model only)
 Three phase, 30 amp (NEMA L15-30P)
 Single phase, 50 amp (NEMA 6-50P)

Accessories

- 10" (254 mm) Saute Pan with tapered sides
- 18"W x 13"D (457 x 330 mm) Half-Size Sheet Pan

**For operation, location and safety information,
 please refer to the Installation & Operating Manual.**



HATCO CORPORATION | P.O. Box 340500 Milwaukee, WI 53234-0500 U.S.A.
 (800) 558-0607 | (414) 671-6350 | www.hatcocorp.com | support@hatcocorp.com



Thermo-Finisher® Food Finishers

Models: TF-1919, -4619, -461R, TFW-461R, TFWM36-3900, -3939, TFWM42-3900, -3939

TF-1919 & TF-4619

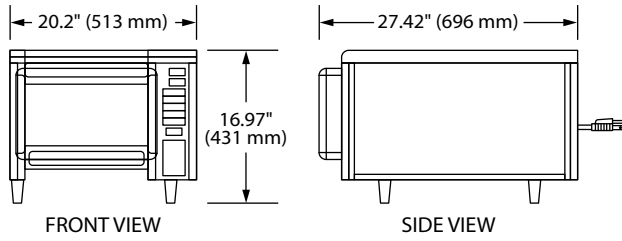

TF-461R

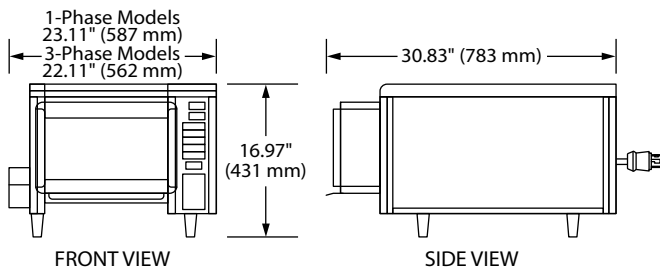

TFW-461R

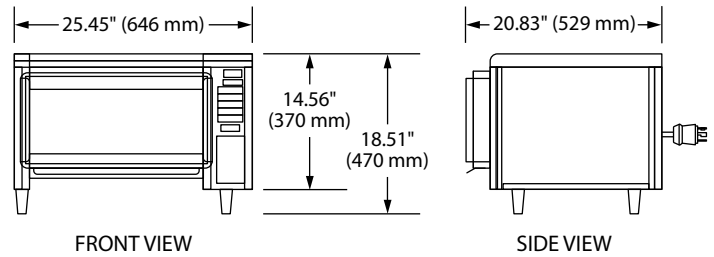

TFWM36-3900 and TFWM42-3900

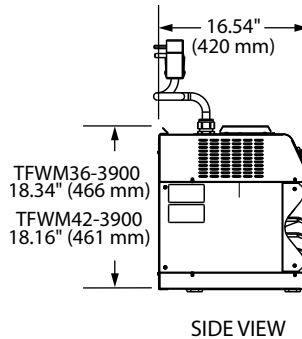
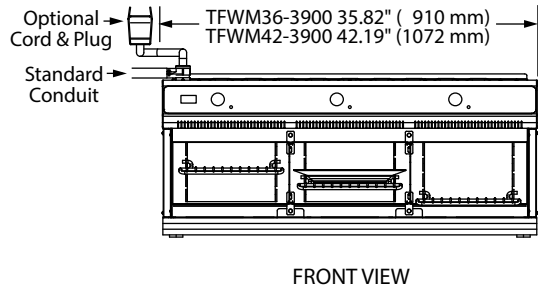

TFWM36-3939 and TFWM42-3939

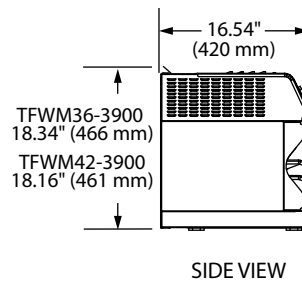
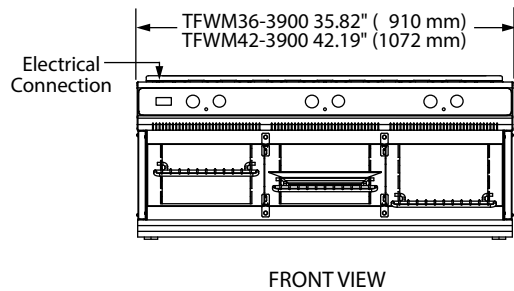



Thermo-Finisher® Food Finishers

Models: TF-1919, -4619, -461R, TFW-461R, TFWM36-3900, -3939, TFWM42-3900, -3939

SPECIFICATIONS Thermo-Finisher® Food Finishers

The shaded areas contain electrical information for International models

Model	Dimensions (W x D x H)	Cavity Opening (W x D x H)	Elements	Voltage	Phase	Watts	Amps	Plug	Cord Location	Ship Weight*
TF-1919	20.2" x 27.42" x 16.97" (513 x 696 x 431 mm)	13" x 18" x 6.38" (330 x 457 x 162 mm)	1 upper, 1 lower	208	Single	4800	23.1	NEMA 6-30P	Top left side, near center	86 lbs. (39 kg)
				240		5000	20.8			
				220	Single	4201	19.1	None†	Top left side, near center	86 lbs. (39 kg)
				240		5000	20.8	NEMA 6-30P		
				380		4532	11.9	4 wire cord†		
TF-4619	20.2" x 27.42" x 16.97" (513 x 696 x 431 mm)	13" x 18" x 6.38" (330 x 457 x 162 mm)	4 upper, 1 lower	208	Three	7200	20.1	NEMA L15-30P	Top left side, near center	90 lbs. (41 kg)
				240		7300	17.6			
				220	Three	6134	16.1	None†	Top left side, near center	90 lbs. (41 kg)
				240/415		7300	10.3	5 wire cord†		
				380		6588	10.1			
TF-461R	Single Phase: 23.11" x 30.83" x 16.97" (587 x 783 x 431 mm) Three Phase: 22.11" x 30.83" x 16.97" (562 x 783 x 431 mm)	13" x 18" x 6.38" (330 x 457 x 162 mm)	4 upper, 1 lower	208	Single	6250	30.0	NEMA 6-50P	Top left side, near center	90 lbs. (41 kg)
					Three		19.0	NEMA L15-30P		
				240	Single	8320	34.7	NEMA 6-50P	Top left side, near center	90 lbs. (41 kg)
				240	Three		21.9	NEMA L15-30P		
				220	Three	6992	20.1	None†	Top left side, near center	90 lbs. (41 kg)
TFW-461R	25.45" x 20.83" x 18.51"• (646 x 529 x 470 mm)	18" x 13" x 6.38" (457 x 330 x 162 mm)	4 upper, 1 lower	208	Single	6250	30.0	NEMA 6-50P	Top left side, near center	90 lbs. (41 kg)
					Three		19.0	NEMA L15-30P		
				240	Single	8320	34.7	NEMA 6-50P	Top left side, near center	90 lbs. (41 kg)
				240	Three		21.9	NEMA L15-30P		
				220	Single	6992	31.8	None†	Top left side, near center	90 lbs. (41 kg)
	Three	20.1								
TFWM36-3900	35.82" x 16.54" x 18.34" (910 x 420 x 466 mm)	Left: 11.12" x 15" x 6.38" (282 x 394 x 162 mm) Middle: 11.43" x 15" x 6.38" (290 x 394 x 162 mm) Right: 11.12" x 15" x 6.38" (282 x 394 x 162 mm)	3 upper	208	Single	7200	34.6	NEMA 6-50P	Top of unit, back left side	165 lbs. (75 kg)
					Three		20.0	NEMA L15-30P		
				240	Single	7500	31.3	NEMA 6-50P		
					Three		18.0	NEMA L15-30P		
TFWM36-3939	35.82" x 16.54" x 18.34" (910 x 420 x 466 mm)	Left: 11.12" x 15" x 6.38" (282 x 394 x 162 mm) Middle: 11.43" x 15" x 6.38" (290 x 394 x 162 mm) Right: 11.12" x 15" x 6.38" (282 x 394 x 162 mm)	3 upper, 3 lower	208	Three	14400	40.0	Hardwired	Top of unit, back left side	170 lbs. (77 kg)
				240			15000			
TFWM42-3900	42.19" x 16.54" x 18.16" (1072 x 420 x 461 mm)	Left: 13.24" x 15.5" x 6.38" (336 x 394 x 162 mm) Middle: 13.55" x 15.5" x 6.38" (344 x 394 x 162 mm) Right: 13.24" x 15.5" x 6.38" (336 x 394 x 162 mm)	3 upper	208	Single	7200	34.6	NEMA 6-50P	Top of unit, back left side	170 lbs. (77 kg)
					Three		20.0	NEMA L15-30P		
				240	Single	7500	31.3	NEMA 6-50P		
					Three		18.0	NEMA L15-30P		
TFWM42-3939	42.19" x 16.54" x 18.16" (1072 x 420 x 461 mm)	Left: 13.24" x 15.5" x 6.38" (336 x 394 x 162 mm) Middle: 13.55" x 15.5" x 6.38" (344 x 394 x 162 mm) Right: 13.24" x 15.5" x 6.38" (336 x 394 x 162 mm)	3 upper, 3 lower	208	Three	14400	40.0	Hardwired	Top of unit, back left side	177 lbs. (80 kg)
				240			15000			

* Shipping weight includes packaging. (TFWM36-3900 and TFWM36-3939 weights are approximate)

† Power cord is attached without a plug

• Height includes 4" (102 mm) legs.

PLUG CONFIGURATIONS

NEMA 6-30P

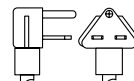

NEMA 6-50P

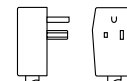

NEMA L15-30P

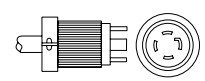

PRODUCT SPECS

Thermo-Finisher® Food Finishers

The Food-Finisher shall be a Thermo-Finisher® model ... as manufactured by the Hatco Corporation, Milwaukee, WI 53234 U.S.A.

The Food Finisher shall be rated at ... watts, ... volts, and be ... inches (millimeters) in overall width. It shall consist of stainless steel interior with fast heating infrared ribbon elements. Special microprocessor to control the temperature and heating

time (excludes TFWM models). Additionally, TFWM models shall consist of cord and plug option (TFWM42-3900 and TFWM36-3900 models only) and countertop unit converter kit.

Warranty consists of 24/7 parts and service assistance (U.S. and Canada only).

HATCO CORPORATION

(800) 558-0607 | (414) 671-6350

P.O. Box 340500 Milwaukee, WI 53234-0500 U.S.A.

www.hatcocorp.com | support@hatcocorp.com