



Project _____

Item # _____

Quantity _____

Hot/Cold Built-In Shelves

Models: HCSSB-2418, -3018, -3618, -4818

HCSBF-24-F, -24-I, -24-S, -36-F, -36-I, -36-S,
-48-F, -48-I, -48-S

HCSBF-24-F, -24-I, -24-S, -36-F, -36-I, -36-S,
-48-F, -48-I, -48-S

Give your operation ultimate flexibility with Hatco's innovative, patented Hot/Cold Built-In Shelves. Available in our signature Hardcoat or in Swanstone®, they easily transition between a heated to cold and cold to heated shelf!

Standard features

- R-513A refrigerant available for California only, please contact Hatco for more information
- The shelves change modes from hot to cold or vice versa in as little as 30 minutes, allowing quick change for different day parts
- Patented thermal break reduces condensation and temperature transfer
- Long, flexible copper refrigerant line, with ability to pull out condensing unit, results in easy service and installation
- Hardcoat aluminum models (HCSBF) are top mount while simulated stone▲ models (HCSSBF, HCSSB) are bottom mount, flush with counter top
- For an integrated look:
 - HCSBF Hot/Cold Shelves match the GRSBF Heated Built-In Shelves
 - HCSSB Hot/Cold Shelves match the GRSSB Heated Built-In Shelves
- Models shipped with Electronic Temperature Control and Condensing Unit
- Control box can be mounted on the front of the cabinet, 4' (1219 mm) from center of shelf
- Condensing unit may be mounted up to 4' (1219 mm) away from the center of shelf
- The Hot/Cold Shelf construction utilizes R-404A
- Easy serviceability with a sight glass, service valves, dryer/filter and a receiver

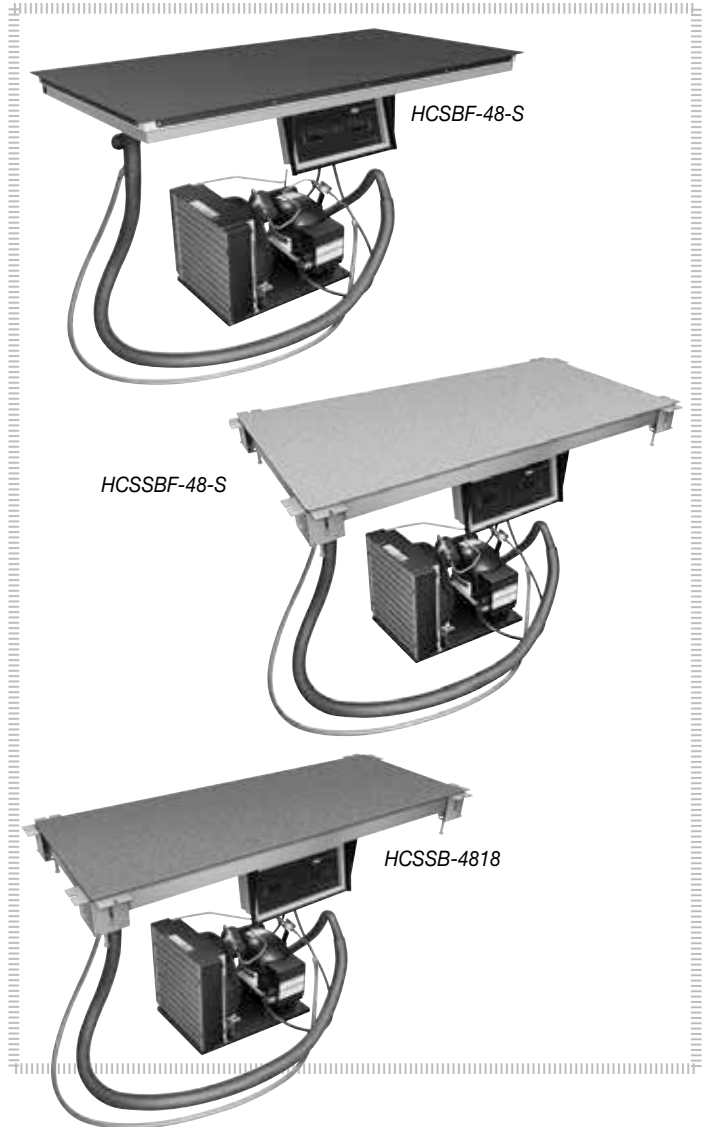

Options (available at time of purchase only)

Simulated stone▲ for HCSSBF and HCSSB models only –

Non-standard colors are non-returnable

Gray Granite Bermuda Sand Night Sky (standard)

Additional four year parts only warranty on the compressor available at time of purchase (U.S. and Canada only)

▲ Models with simulated stone are Swanstone®

For operation, location and safety information, please refer to the Installation & Operating Manual.



HATCO CORPORATION | P.O. Box 340500 Milwaukee, WI 53234-0500 U.S.A.
(800) 558-0607 | (414) 671-6350 | www.hatcocorp.com | support@hatcocorp.com



Hot/Cold Built-In Shelves

Models: HCSSB-2418, -3018, -3618, -4818

HCSSBF-24-F, -24-I, -24-S, -36-F, -36-I, -36-S, -48-F, -48-I, -48-S

HCSBF-24-F, -24-I, -24-S, -36-F, -36-I, -36-S, -48-F, -48-I, -48-S

HCSSB, HCSSBF

FRONT

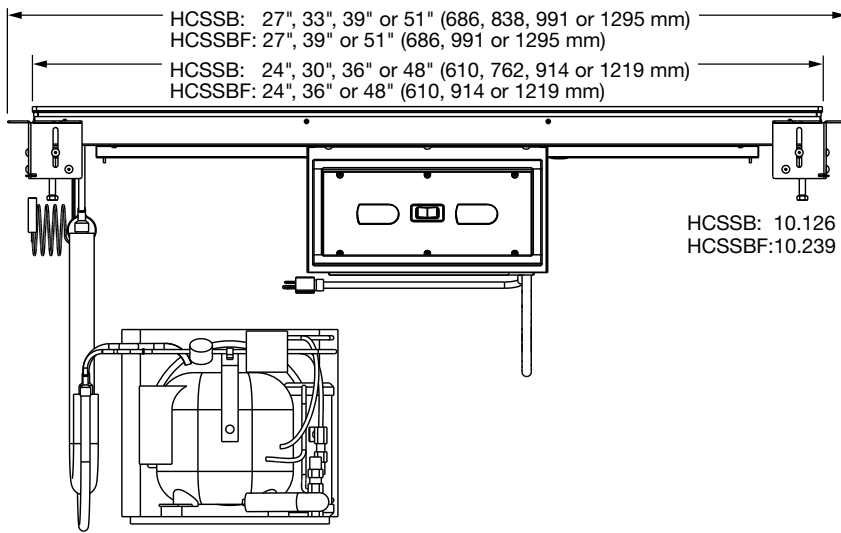

SIDE

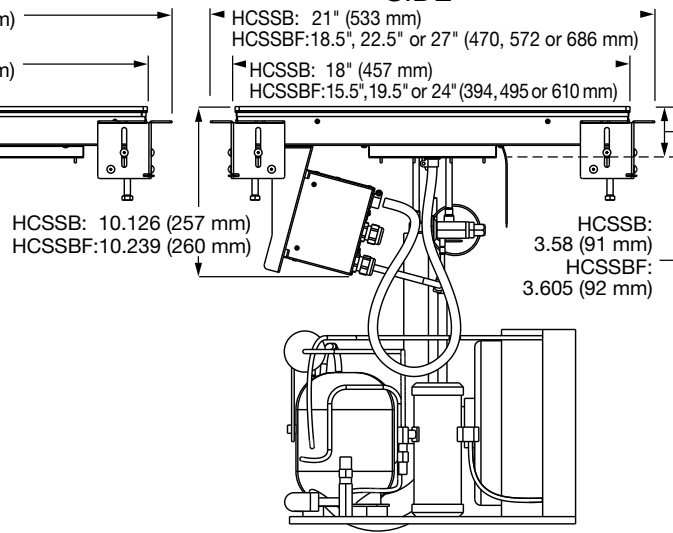

HCSBF

FRONT

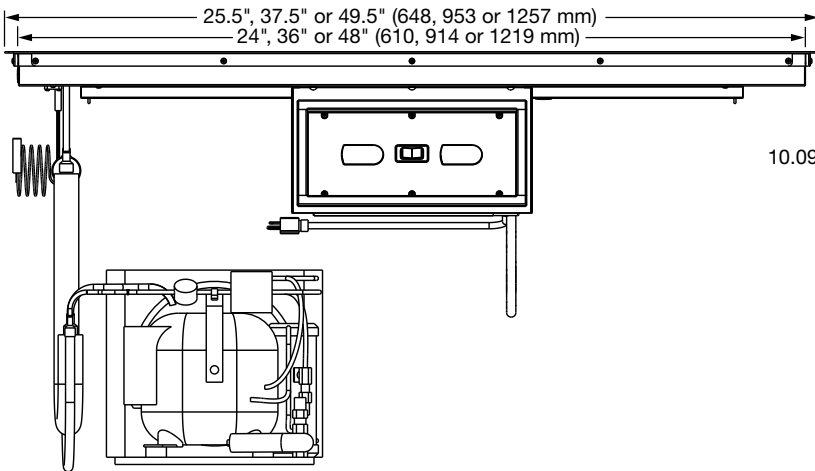

SIDE

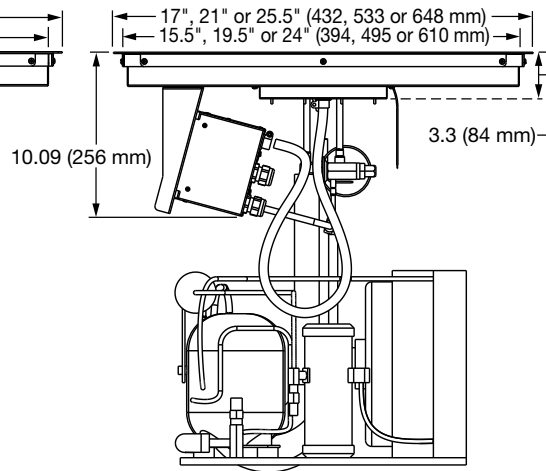

SPECIFICATIONS

Hot/Cold Simulated Stone[▲] Shelves - Built-In (flush to countertop) *

The shaded areas contain electrical information for International models

Model	Overall Dimensions W x D x H	Usable Shelf Space W x D of heated/cooled surface	Comp. Size HP	Voltage*	Cold Side Watts	Hot Side Watts	Amps	Hz	Plug	Approximate Ship Weight
HCSSB-2418	27" x 21" x 10.126" (686 x 533 x 257 mm)	24" x 18" (610 x 457 mm)	1/4	120	804	405	6.7	60	NEMA 5-15P	133 lb. (61 kg)
				220	616	371	2.8	50	CEE 7-7 Schuko BS-1363, AS3112	
				230	667	405	2.9			
			1/3	240	744	441	3.1	60	BS-1363	
				220	686	371	3.1			
				230	749	405	3.3			
HCSSB-3018	33" x 21" x 10.126" (838 x 533 x 257 mm)	30" x 18" (762 x 457 mm)	1/4	120	804	510	6.7	60	NEMA 5-15P	150 lb. (68 kg)
				220	616	467	2.8	50	CEE 7-7 Schuko BS-1363, AS3112	
				230	667	510	2.9			
			1/3	240	744	555	3.1	60	BS-1363	
				220	686	467	3.1			
				230	749	510	3.3			
				240	816	555	3.4			

▲Models with simulated stone are Swanstone® *All voltages non-CE * Contact Hatco for R-513A refrigerant specifications.

continued on next page

HATCO CORPORATION

P.O. Box 340500 Milwaukee, WI 53234-0500 U.S.A.

(800) 558-0607

(414) 671-6350

www.hatcocorp.com

support@hatcocorp.com



Hot/Cold Built-In Shelves

Models: HCSSB-2418, -3018, -3618, -4818

HCSSBF-24-F, -24-I, -24-S, -36-F, -36-I, -36-S, -48-F, -48-I, -48-S

HCSSBF-24-F, -24-I, -24-S, -36-F, -36-I, -36-S, -48-F, -48-I, -48-S

SPECIFICATIONS

Hot/Cold Simulated Stone[▲] Shelves - Built-In (flush to countertop) * *continued from previous page*

The shaded areas contain electrical information for International models

Model	Overall Dimensions W x D x H	Usable Shelf Space W x D of heated/cooled surface	Comp. Size HP	Voltage*	Cold Side Watts	Hot Side Watts	Amps	Hz	Plug	Approximate Ship Weight	
HCSSB-3618	39" x 21" x 10.126" (991 x 533 x 257 mm)	36" x 18" (914 x 457 mm)	1/3	1/4	120	804	610	6.7	60	NEMA 5-15P	160 lb. (73 kg)
				50	220	616	558	2.8	CEE 7-7 Schuko, BS-1363, AS3112		
					230	667	610	2.9			
					240	744	664	3.1			
				60	220	686	558	3.1	BS-1363		
					230	749	610	3.3			
					240	816	664	3.4			
HCSSB-4818	51" x 21" x 10.126" (1295 x 533 x 257 mm)	48" x 18" (1219 x 457 mm)	1/3	1/3	120	468	815	6.8	60	NEMA 5-15P	187 lb. (85 kg)
				50	220	807	746	3.7	CEE 7-7 Schuko, BS-1363, AS3112		
					230	882	815	3.8			
					240	960	887	4.0			
				60	220	686	746	3.1	BS-1363		
					230	749	815	3.3			
					240	816	887	3.4			

SPECIFICATIONS

Hot/Cold Simulated Stone[▲] Built-In Shelves - Flush Top *

The shaded areas contain electrical information for International models

Model	Overall Dimensions W x D x H	Usable Shelf Space W x D of heated/cooled surface	Comp. Size HP	Volts*	Cold Side Watts	Hot Side Watts	Amps	Hz	Plug	Approximate Ship Weight	
HCSSBF-24-F	27" x 18.5" x 10.239 (686 x 470 x 260 mm)	24" x 15.5" (610 x 394 mm)	1/3	1/4	120	804	355	6.7	60	NEMA 5-15P	139 lbs. (64 kg)
				50	220	616	325	2.8	CEE 7-7 Schuko, BS-1363, AS3112		
					230	667	355	2.9			
					240	744	387	3.1			
				60	220	686	325	3.1	BS-1363		
					230	749	355	3.3			
					240	816	387	3.4			
HCSSBF-24-I	27" x 22.5" x 10.239 (686 x 572 x 260 mm)	24" x 19.5" (610 x 495 mm)	1/3	1/4	120	804	445	6.7	60	NEMA 5-15P	134 lbs. (61 kg)
				50	220	616	407	2.8	CEE 7-7 Schuko, BS-1363, AS3112		
					230	667	445	2.9			
					240	744	485	3.1			
				60	220	686	407	3.1	BS-1363		
					230	749	445	3.3			
					240	816	485	3.4			
HCSSBF-24-S	27" x 27" x 10.239 (686 x 686 x 260 mm)	24" x 24" (610 x 610 mm)	1/3	1/4	120	804	550	6.7	60	NEMA 5-15P	150 lbs. (68 kg)
				50	220	616	503	2.8	CEE 7-7 Schuko, BS-1363, AS3112		
					230	667	550	2.9			
					240	744	599	3.1			
				60	220	686	503	3.1	BS-1363		
					230	749	550	3.3			
					240	816	599	3.4			
HCSSBF-36-F	39" x 18.5" x 10.239 (991 x 470 x 260 mm)	36" x 15.5" (914 x 394 mm)	1/3	1/4	120	804	530	6.7	60	NEMA 5-15P	146 lbs. (66 kg)
				50	220	616	485	2.8	CEE 7-7 Schuko, BS-1363, AS3112		
					230	667	530	2.9			
					240	744	577	3.1			
				60	220	686	485	3.1	BS-1363		
					230	749	530	3.3			
					240	816	577	3.4			
HCSSBF-36-I	39" x 22.5" x 10.239 (991 x 572 x 260 mm)	36" x 19.5" (914 x 495 mm)	1/3	1/3	120	468	670	6.5	60	NEMA 5-15P	164 lbs. (75 kg)
				50	220	807	613	3.7	CEE 7-7 Schuko, BS-1363, AS3112		
					230	882	670	3.8			
					240	960	730	4.0			
				60	220	686	613	3.1	BS-1363		
					230	749	670	3.3			
					240	816	730	3.4			

▲Models with simulated stone are Swanstone® *All voltages non-CE * Contact Hatco for R-513A refrigerant specifications.

(continued from previous page)



Hot/Cold Built-In Shelves

Models: HCSSB-2418, -3018, -3618, -4818

HCSSBF-24-F, -24-I, -24-S, -36-F, -36-I, -36-S, -48-F, -48-I, -48-S

HCSBF-24-F, -24-I, -24-S, -36-F, -36-I, -36-S, -48-F, -48-I, -48-S

SPECIFICATIONS

Hot/Cold Simulated Stone[▲] Built-In Shelves - Flush Top *

(continued from previous page)

The shaded areas contain electrical information for International models

Model	Overall Dimensions W x D x H	Usable Shelf Space W x D of heated/cooled surface	Comp. Size HP	Volts*	Cold Side Watts	Hot Side Watts	Amps	Hz	Plug	Approximate Ship Weight	
HCSSBF-36-S	39" x 27" x 10.239 (991 x 686 x 260 mm)	36" x 24" (914 x 610 mm)	1/3	120	468	825	6.9	60	NEMA 5-15P	180 lbs. (82 kg)	
				3/8	220	807	755	3.7	50		CEE 7-7 Schuko, BS-1363, AS3112
					230	882	825	3.8			
			240		960	898	4.0				
			1/3	220	686	755	3.1	60	BS-1363		
				230	749	825	3.3				
240	816	898		3.4							
HCSSBF-48-F	51" x 18.5" x 10.239 (1295 x 470 x 260 mm)	48" x 15.5" (1219 x 394 mm)	1/3	120	468	710	6.5	60	NEMA 5-15P	183 lbs. (82 kg)	
				3/8	220	807	650	3.7	50		CEE 7-7 Schuko, BS-1363, AS3112
					230	882	710	3.8			
			240		960	773	4.0				
			1/3	220	686	650	3.1	60	BS-1363		
				230	749	710	3.3				
240	816	773		3.4							
HCSSBF-48-I	51" x 22.5" x 10.239 (1295 x 572 x 260 mm)	48" x 19.5" (1219 x 495 mm)	1/3	120	468	890	7.4	60	NEMA 5-15P	195 lbs. (89 kg)	
				3/8	220	807	814	3.7	50		CEE 7-7 Schuko, BS-1363, AS3112
					230	882	890	3.8			
			240		960	969	4.0				
			1/3	220	686	814	3.1	60	BS-1363		
				230	749	890	3.3				
240	816	969		3.4							
HCSSBF-48-S	51" x 27" x 10.239 (1295 x 686 x 260 mm)	48" x 24" (1219 x 610 mm)	1/2	120	1380	1100	11.5	60	NEMA 5-15P	220 lbs. (100 kg)	
				1/3	220	1190	1006	5.4	50		CEE 7-7 Schuko, BS-1363, AS3112
					230	1300	1100	5.7			
			240		1416	1198	5.9				
			1/3	220	1210	1006	5.5	60	BS-1363		
				230	1322	1100	5.8				
240	1440	1198		6.0							

SPECIFICATIONS

Hot/Cold Shelves - Built-In, Flush Top (Aluminum) *

The shaded areas contain electrical information for International models

Model	Overall Dimensions W x D x H	Usable Shelf Space W x D of heated/cooled surface	Comp. Size HP	Volts*	Cold Side Watts	Hot Side Watts	Amps	Hz	Plug	Approximate Ship Weight	
HCSBF-24-F	25.5" x 17" x 10.09" (648 x 432 x 256 mm)	24" x 15.5" (610 x 394 mm)	1/4	120	804	355	6.7	60	NEMA 5-15P	119 lbs. (54 kg)	
				1/3	220	616	325	2.8	50		CEE 7-7 Schuko, BS-1363, AS3112
					230	667	355	2.9			
			240		744	387	3.1				
			1/3	220	686	325	3.1	60	BS-1363		
				230	749	355	3.3				
240	816	387		3.4							
HCSBF-24-I	25.5" x 21" x 10.09" (648 x 533 x 256 mm)	24" x 19.5" (610 x 495 mm)	1/4	120	804	445	6.7	60	NEMA 5-15P	126 lbs. (57 kg)	
				1/3	220	616	407	2.8	50		CEE 7-7 Schuko, BS-1363, AS3112
					230	667	445	2.9			
			240		744	485	3.1				
			1/3	220	686	407	3.1	60	BS-1363		
				230	749	445	3.3				
240	816	485		3.4							
HCSBF-24-S	25.5" x 25.5" x 10.09" (648 x 648 x 256 mm)	24" x 24" (610 x 610 mm)	1/4	120	804	550	6.7	60	NEMA 5-15P	140 lbs. (64 kg)	
				1/3	220	616	503	2.8	50		CEE 7-7 Schuko, BS-1363, AS3112
					230	667	550	2.9			
			240		744	599	3.1				
			1/3	220	686	503	3.1	60	BS-1363		
				230	749	550	3.3				
240	816	599		3.4							

▲Models with simulated stone are Swanstone® *All voltages non-CE * Contact Hatco for R-513A refrigerant specifications.

(continued on next page)



Hot/Cold Built-In Shelves

Models: HCSSB-2418, -3018, -3618, -4818

HCSBF-24-F, -24-I, -24-S, -36-F, -36-I, -36-S, -48-F, -48-I, -48-S

HCSBF-24-F, -24-I, -24-S, -36-F, -36-I, -36-S, -48-F, -48-I, -48-S

SPECIFICATIONS

Hot/Cold Shelves - Built-In, Flush Top (Aluminum)**

The shaded areas contain electrical information for international models

Model	Overall Dimensions W x D x H	Usable Shelf Space W x D of heated/cooled surface	Comp. Size HP	Volts*	Cold Side Watts	Hot Side Watts	Amps	Hz	Plug	Approximate Ship Weight
HCSBF-36-F	37.5" x 17" x 10.09" (953 x 432 x 256 mm)	36" x 15.5" (914 x 394 mm)	1/4	120	804	530	6.7	60	NEMA 5-15P	155 lbs. (70 kg)
				220	616	485	2.8	50	CEE 7-7 Schuko, BS-1363, AS3112	
			1/3	230	667	530	2.9			
				240	744	577	3.1			
				220	686	485	3.1			
				230	749	530	3.3			
240	816	577	3.4							
HCSBF-36-I	37.5" x 21" x 10.09" (953 x 533 x 256 mm)	36" x 19.5" (914 x 495 mm)	1/3	120	468	670	6.5	60	NEMA 5-15P	159 lbs. (72 kg)
				220	807	613	3.7	50	CEE 7-7 Schuko, BS-1363, AS3112	
			3/8	230	882	670	3.8			
				240	960	730	4.0			
				220	686	613	3.1			
				230	749	670	3.3			
240	816	730	3.4							
HCSBF-36-S	37.5" x 25.5" x 10.09" (953 x 648 x 256 mm)	36" x 24" (914 x 610 mm)	1/3	120	468	825	6.9	60	NEMA 5-15P	164 lbs. (74 kg)
				220	807	755	3.7	50	CEE 7-7 Schuko, BS-1363, AS3112	
			3/8	230	882	825	3.8			
				240	960	898	4.0			
				220	686	755	3.4			
				230	749	825	3.5			
240	816	898	3.7							
HCSBF-48-F	49.5" x 17" x 10.09" (1257 x 432 x 256 mm)	48" x 15.5" (1219 x 394 mm)	1/3	120	468	710	6.5	60	NEMA 5-15P	161 lbs. (74 kg)
				220	807	650	3.7	50	CEE 7-7 Schuko, BS-1363, AS3112	
			3/8	230	882	710	3.8			
				240	960	773	4.0			
				220	686	650	3.1			
				230	749	710	3.3			
240	816	773	3.4							
HCSBF-48-I	49.5" x 21" x 10.09" (1257 x 533 x 256 mm)	48" x 19.5" (1219 x 495 mm)	1/3	120	468	890	7.4	60	NEMA 5-15P	172 lbs. (78 kg)
				220	807	814	3.7	50	CEE 7-7 Schuko, BS-1363, AS3112	
			3/8	230	882	890	3.9			
				240	960	969	4.0			
				220	686	814	3.7			
				230	749	890	3.9			
240	816	969	4.0							
HCSBF-48-S	49.5" x 25.5" x 10.09" (1257 x 648 x 256 mm)	48" x 24" (1219 x 610 mm)	1/2	120	1380	1100	11.5	60	NEMA 5-15P	204 lbs. (93 kg)
				220	1190	1006	5.4	50	CEE 7-7 Schuko, BS-1363, AS3112	
			1/2	230	1300	1100	5.7			
				240	1416	1198	5.9			
				220	1210	1006	5.5			
				230	1322	1100	5.8			
240	1440	1198	6.0							

*All voltages non-CE

** Contact Hatco for R-513A refrigerant specifications.



Hot/Cold Built-In Shelves

Models: HCSSB-2418, -3018, -3618, -4818

HCSSBF-24-F, -24-I, -24-S, -36-F, -36-I, -36-S, -48-F, -48-I, -48-S

HCSBF-24-F, -24-I, -24-S, -36-F, -36-I, -36-S, -48-F, -48-I, -48-S

PLUG CONFIGURATION

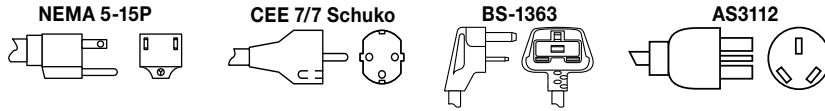

COUNTERTOP CUTOUT SIZE

See Installation and Operating Manual for more information

Model	Width with .375" (10 mm) radii	Depth with .375" (10 mm) radii
HCSSB-2418	24.375" (619 mm)	18.375" (467 mm)
HCSSB-3018	30.375" (772 mm)	18.375" (467 mm)
HCSSB-3618	36.375" (924 mm)	18.375" (467 mm)
HCSSB-4818	48.375" (1229 mm)	18.375" (467 mm)

Model	Width with .375" (10 mm) radii	Depth with .375" (10 mm) radii
HCSSBF-24-F	24.375" (619 mm)	15.875" (403 mm)
HCSSBF-24-I	24.375" (619 mm)	19.875" (505 mm)
HCSSBF-24-S	24.375" (619 mm)	24.375" (619 mm)
HCSSBF-36-F	36.375" (924 mm)	15.875" (403 mm)
HCSSBF-36-I	36.375" (924 mm)	19.875" (505 mm)
HCSSBF-36-S	36.375" (924 mm)	24.375" (619 mm)
HCSSBF-48-F	48.375" (1229 mm)	15.875" (403 mm)
HCSSBF-48-I	48.375" (1229 mm)	19.875" (505 mm)
HCSSBF-48-S	48.375" (1229 mm)	24.375" (619 mm)

Model	Width		Depth	
	Minimum	Maximum	Minimum	Maximum
HCSBF-24-F	24.6" (625 mm)	25.0" (635 mm)	16.1" (409 mm)	16.5" (419 mm)
HCSBF-24-I	24.6" (625 mm)	25.0" (635 mm)	20.1" (511 mm)	20.5" (521 mm)
HCSBF-24-S	24.6" (625 mm)	25.0" (635 mm)	24.6" (625 mm)	25.0" (635 mm)
HCSBF-36-F	36.6" (930 mm)	37.0" (940 mm)	16.1" (409 mm)	16.5" (419 mm)
HCSBF-36-I	36.6" (930 mm)	37.0" (940 mm)	20.1" (511 mm)	20.5" (521 mm)
HCSBF-36-S	36.6" (930 mm)	37.0" (940 mm)	24.6" (625 mm)	25.0" (635 mm)
HCSBF-48-F	48.6" (1234 mm)	49.0" (1245 mm)	16.1" (409 mm)	16.5" (419 mm)
HCSBF-48-I	48.6" (1234 mm)	49.0" (1245 mm)	20.1" (511 mm)	20.5" (521 mm)
HCSBF-48-S	48.6" (1234 mm)	49.0" (1245 mm)	24.6" (625 mm)	25.0" (635 mm)

Model	Width (should not exceed)	Height (should not exceed)
Control Box	13.0625" (332 mm)	5.75" 146 mm)

PRODUCT SPECS Hot/Cold Built-In Shelves

The Hot/Cold Built-In Shelf, patent pending, shall be model ... as manufactured by the Hatco Corporation, Milwaukee, WI 53234 U.S.A.

The Hot/Cold Built-In Shelf shall be rated at ... watts, ... volts, and ... inches (millimeters) in overall width. It shall utilize R-404A or R-513A refrigerant and consist of

food-safe material, Condenser attached to Evaporator with 5 foot (1524 mm) flexible tubing, adjustable bracket with cord and plug attached.

Warranty consists of 24/7 parts and service assistance (U.S. and Canada only).

HATCO CORPORATION | P.O. Box 340500 Milwaukee, WI 53234-0500 U.S.A.
 (800) 558-0607 | (414) 671-6350 | www.hatcocorp.com | support@hatcocorp.com