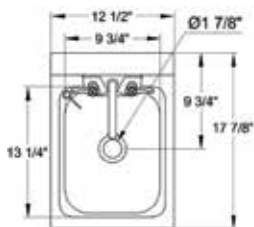
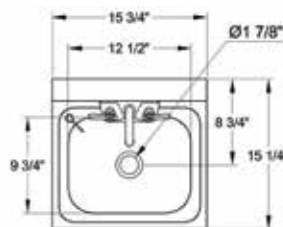
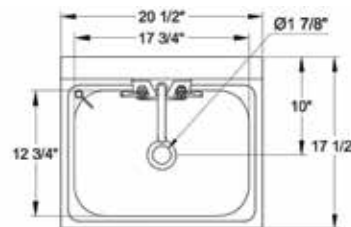
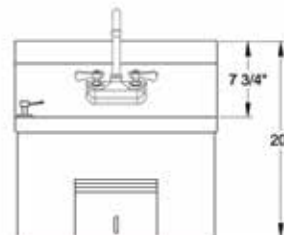
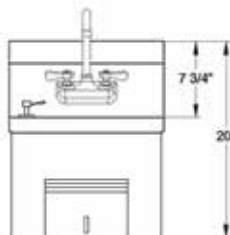
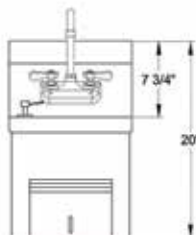

Splash Guard Hand Sink w/Towel & Soap Dispensers

HS-1217TSSG

HS-1615TSSG

HS-2017TSSG

Order No	Description	Weight lbs/case	Pack/case
HS-1217TSSG	Under Mount Paper Towel & Deck Mount Soap Dispenser	26	1
HS-1615TSSG	Standard Under Mount Paper Towel & Deck Mount Soap Dispenser	26	1
HS-2017TSSG	Extra Wide Under Mount Paper Towel & Deck Mount Soap Dispenser	32	1

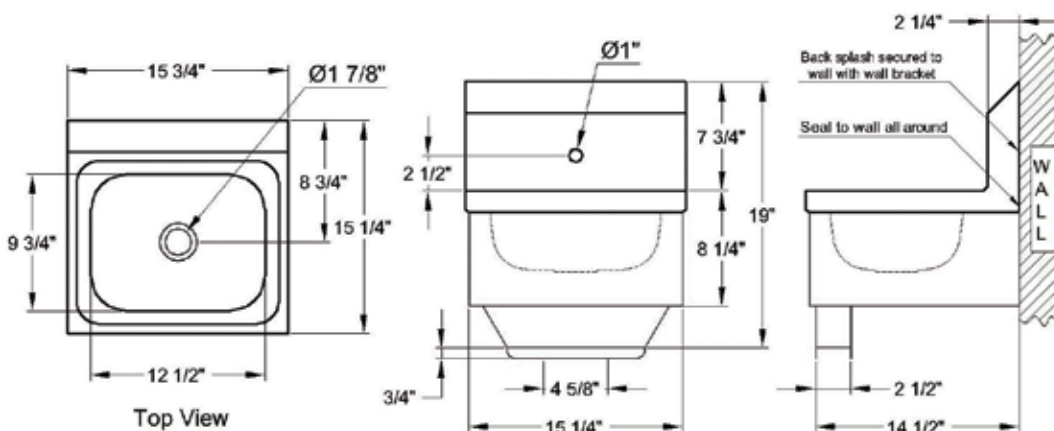
Knee Operated Hand Sink

HS-1615KG

HS-1615KSSG

Order No	Description	Weight lbs/case	Pack/case
HS-1615KG	Hand Sink w/Knee Operated Valve	21	1
HS-1615KSSG	Hand Sink w/Knee Operated Valve & Splash Guards	23.4	1

Hand Sinks (61~68)