



18600PTBMP

# 18600PTBMP

## Self-Contained Refrigerated Pizza Prep Tables

Project \_\_\_\_\_  
 Item \_\_\_\_\_  
 Quantity \_\_\_\_\_  
 CSI Section 11400  
 Approved \_\_\_\_\_  
 Date \_\_\_\_\_

### Models

- 18648PTBMP 48" Raised Rail Pizza Table, 6 1/3 pan capacity
- 18660PTBMP 60" Raised Rail Pizza Table, 7 1/3 pan capacity
- 18672PTBMP 72" Raised Rail Pizza Table, 9 1/3 pan capacity
- 18691PTBMP 91" Raised Rail Pizza Table, 11 1/3 pan capacity
- 18699PTBMP 99" Raised Rail Pizza Table, 12 1/3 pan capacity
- 186114PTBMP 114" Raised Rail Pizza Table, 14 1/3 pan capacity



18691PTBMP

### Standard Features

- Top, sides and ends are constructed of 18-gauge stainless steel
- Units are mechanically cooled with diestamped openings to accommodate 12" x 20" hotel pans or fractional pans
- Pans and adapter bars by others
- Pans are recessed 2" to provide proper cooling for NSF 7
- High density environmentally friendly, Kyoto Protocol Compliant, Non ODP (Ozone Depletion Potential), Non GWP (Global Warming Potential) polyurethane foam throughout unit
- Dart style quick change gaskets
- Stainless steel removable hinged covers
- On/off switch and rail on/off is located behind the louver
- Front louver provides access and air flow to the condensing unit
- 8' long electrical cord
- Environmentally friendly R290 refrigerant
- Three year parts and labor warranty and an additional two year compressor parts warranty
- Electronic temperature control

### Options & Accessories

- Stainless steel back
- Laminate facing (full front)
- Laminate end
- Laminate back
- Tray racks
- Cutting board (.5" x 20")
- Legs, set of four or six
- Cheese grates with removable catch pans
- 18" deep single tier stainless steel overshef
- 19", 27" or 32" wide refrigerated drawers (2) high, holds 6" deep pans
- 19", 27" or 32" wide refrigerated drawers (3) high, holds 4" deep pans
- Lock
- 4" casters
- 6" legs
- Additional shelf (specify door size)
- Celsius readout for electronic control
- Fan assist package for rail

### Specifications

**Exterior Top:** Constructed of one-piece 18-gauge stainless steel, with integral 2.12" (5cm) high square nosing at the front. Top has a mechanically cooled refrigerated raised rail at the rear with openings to accommodate pans (provided by others). Rail interior is 22-gauge stainless steel. Raised rail openings have 18-gauge stainless steel removable lids. Unit is equipped with separate expansion valve and on/off switch for refrigerated rail. Temperature in top openings maintains 33°F (1°C) to 41°F (5°C) with pans recessed 2" (5cm) at 86°F ambient room temperature, meeting NSF 7 requirements.

**Exterior Back and Bottom:** 24-gauge galvanized steel. Exterior ends are finished with stainless steel.

**Base Interior:** Stainless steel back and bottom. Base interior sides and door frames are thermoformed ABS plastic. Each interior door section has (1) 25" (64cm) deep removable epoxy coated wire shelf. Base is insulated with 2" (5cm) high density foamed in place environmentally friendly, Kyoto Protocol Compliant, Non ODP (Ozone Depletion Potential), Non GWP (Global Warming Potential) polyurethane. End of base has a machine compartment with condensing unit installed.

**Door(s):** 22-gauge stainless steel exterior front, with a thermoformed ABS plastic interior liner.

**Refrigeration System:** R290 refrigerant, and maintains 36°F (2°C) to 40°F (4°C) interior cabinet temperature. Interior cabinet is cooled with mullion style blower coils (coated) with expansion valves mounted between each door/drawer section for even air and temperature control.

**Electronic temperature controls** and pre-wired condensing unit with hot gas condensate evaporator are installed in the machine compartment. Electronic control for base reads air temperature. Electronic control for rail displays temperature for set point purposes only. Display does not reflect air or product temps in unit. On/Off switches for rail and base are located behind the louvered panel.

**Electrical Connections:** 115 volt, 60 Hertz, single phase.

Unit is wired with 3-wire, grounded, maximum 8' (2.4m) cord and plug.

**Casters:** Equipment is mounted on 5" (13cm) diameter casters; overall height of casters is 6.13" (16cm).



R290

# 18600PTBMP

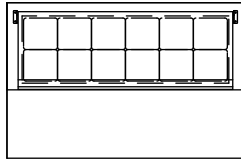

18648PTBMP

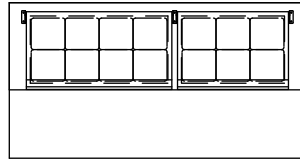

18660PTBMP

31.50in  
[80.01cm]

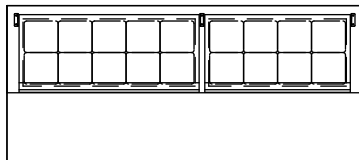
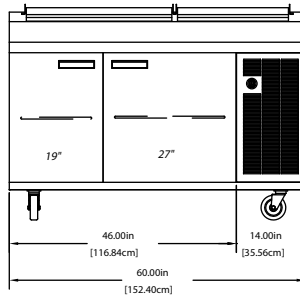
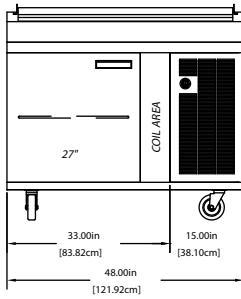

18672PTBMP

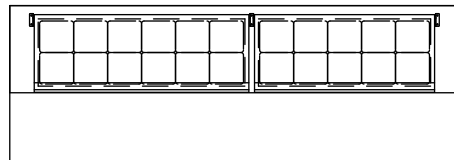

18691PTBMP

31.50in  
[80.01cm]

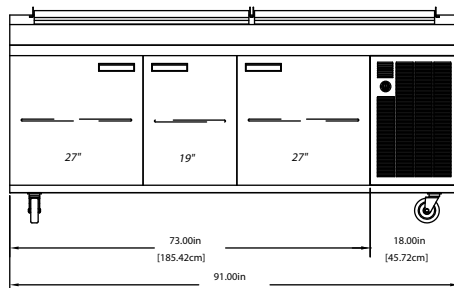
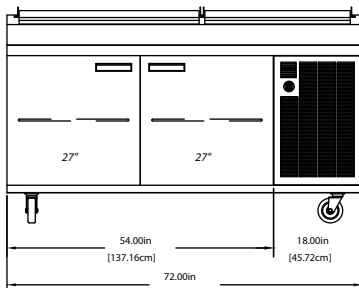

# 18600PTBMP

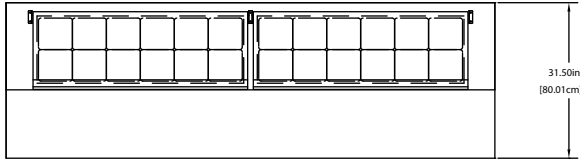

## 18699PTBMP

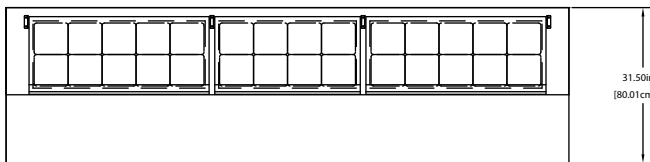
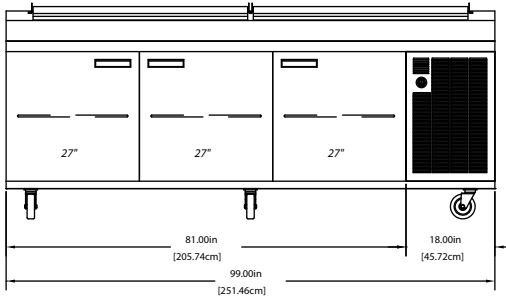

## 186114PTBMP

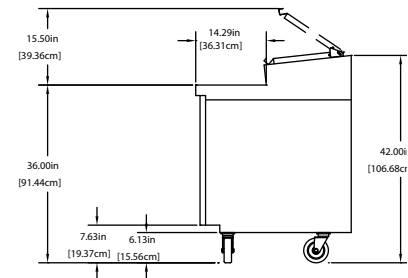
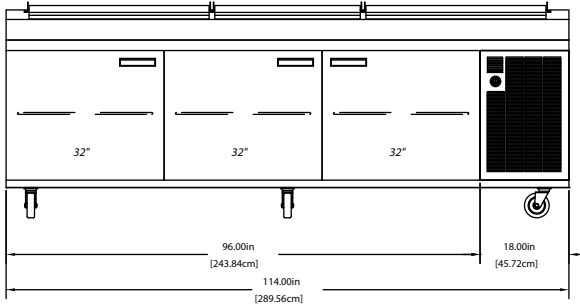

TYPICAL END

## Mechanical Data

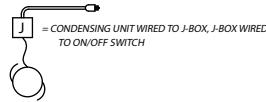
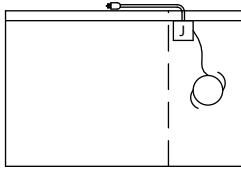

## Door Swing

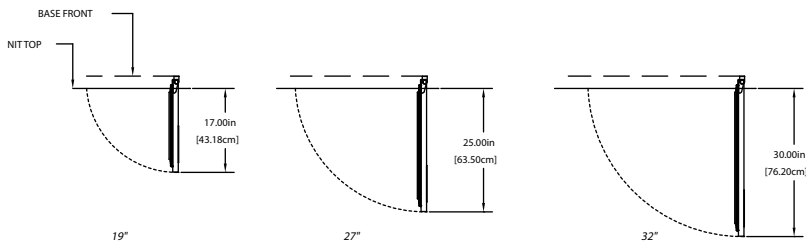

## 18600PTBMP

### Specifications

Model	Pan Capacity (1/6)	# of Shelves	Shelf Area	Volume	BTU Load Base/Rail	BTU Sys. Cap Base/Rail	H.P.	V/Hz/Ph	Amps	Nema Plug	Ship Weight
18648PTBMP	12	1	3.95	9.36	356/253	2128/1037	0.25	115/60/1	4.7	5-15P	520lbs/236kg
18660PTBMP	14	2	6.51	13.81	421/354	2128/1230	0.25	115/60/1	4.7	5-15P	575lbs/260kg
18672PTBMP	18	2	7.9	16.52	367/476	1648/1158	(2) 0.20	115/60/1	6.5	5-15P	635lbs/288kg
18691PTBMP	22	3	10.29	22.35	531/608	1705/1199	(2) 0.20	115/60/1	6.5	5-15P	770lbs/349kg
18699PTBMP	24	3	11.85	25.07	561/658	1922/1336	(2) 0.20	115/60/1	6.5	5-15P	805lbs/365kg
186114PTBMP	28	3	14.46	30.16	616/750	1922/1405	(2) 0.20	115/60/1	6.5	5-15P	927lbs/420kg

Welbilt reserves the right to make changes to the design or specifications without prior notice.