

# InnoGear

## Aroma Diffuser User Manual

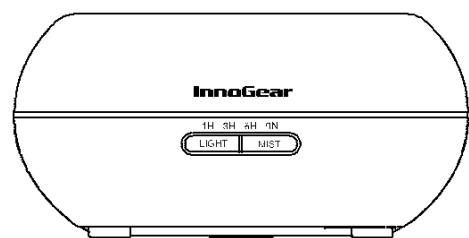

Aroma Diffuser



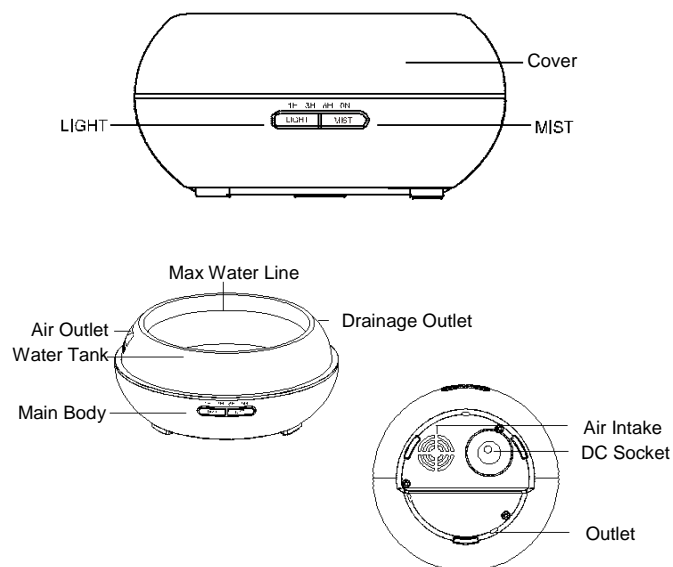

User Manual

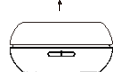
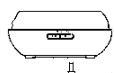

Aroma Diffuser

### Operation

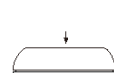
User Manual

-  Lift up the cover.
-  Connect the included AC adapter to the DC port at the basin.
-  Add water (not exceeding the max line) and a few drops of oil into the water tank.
-  Put the cover back on, and then plug the AC adapter into the home power supply socket.
-  **LIGHT button**  
Press once to turn on the light and it begins to cycle through colors.  
The color will change per press.  
Hold for 3 seconds to turn off the light.

Aroma Diffuser

User Manual

6.

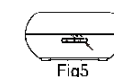

#### MIST button

First press -- turn on and set a 1-hour timer  
Second press -- set a 3-hour timer.  
Third press -- set a 6-hour timer.  
Fourth press -- continual working mode.  
Fifth press -- turn off diffuser.  
Hold for 3 seconds -- beep twice for low mist;  
beep once for strong mist.

### Specification

Dimensions	Approx. 168.5 x 83.5 mm
Weight (excluding adapter)	Approx. 420g
Power: input/ output	AC 100-240V 50/60Hz DC 24V 650mA
Length of cord	Approx. 170cm
Electric consumption	Approx. 14W
Time mode	1H/ 3H/ 6H/ ON
Tank capacity	200ml
LED quantity	Three LEDs
Materials	PP/ ABS/PC
Ultrasonic frequency	2.4MHz

Aroma Diffuser

User Manual

### Troubleshooting

Cannot turn on	Is there enough water in the tank? --Please add enough water but do not exceed the MAX line. Is the AC adapter connected correctly? --Please unplug, check and re-plug correctly.
No mist or low mist	Not enough water or too much water? --Add the right amount of water but do not exceed the MAX line. Dust on the ultrasonic film? --Clean the product according to the instructions. Dust on the air intake? --If the air intake is dirty, mist will not come out. Just clean it.
Water leakage	Is there any crack at the bottom of the water tank? --Please check if there is any tiny crack at the bottom of diffuser through which water can leak. If you find a crack upon receipt of this product, please contact us for a free replacement. Is steam water inside the lid wiped out? --Wipe out steam water after each use, making sure the inner cap is completely dry before refilling in case steam water may leak out while putting lid back on. Upper lid and inner cap installed improperly? --Remove and re-install properly. Align the inner cap nozzle with the mist outlet of lid when installing. Low temperature or high humidity? --In this case, mist may condense quickly into water drops.

Aroma Diffuser

User Manual

### FAQ

- Q: Why can't I find the power adapter upon receipt of this product?  
A: The power adapter is packed in the water tank. Please lift up the diffuser cap to find it.
- Q: Why can't I smell anything?  
A: The strength of scent from different essential oils may vary. Choose a strong scented oil and don't put the diffuser near the air conditioner, fan or window.

- Q: Can the light be set for one specific color only?  
A: Yes. Just press the LIGHT button.

- Q: Can I turn the light off and just use the mist?  
A: Yes. There are separate buttons for the light and the mist.

Aroma Diffuser

User Manual

### Attention

- Oil mist can damage wooden and painted surfaces, so wipe up any residue quickly and be careful not to drip onto the surface of the container.
- The power adapter is packed in the water tank. Please lift up the diffuser cap to find it.
- To prolong the life span of the diffuser, do not use mineral water.
- Do not exceed the MAX line when filling water, no more than 200ml.
- Do not open the upper lid during operation. Please turn off the diffuser first, otherwise the water and oil will splash and oil will stick to the outside of the tank which may make the upper lid harder to open in future use.
- Due to anti-dry protection, the diffuser will shut down automatically when the water is lower than a certain level.
- There are many factors that may affect the mist including water type, humidity, capacity, temperature and air currents.
- It's normal that the amount and intensity of the mist change during operation.
- Please only use 100% essential oil with this diffuser. Low quality oil that contains chemicals, spices, or impurities may cause malfunction.

Aroma Diffuser

User Manual

### Maintenance

Please clean the product as following after using 5-6 times (or 2-3 days):

- Turn off the power, unplug the power cord, and remove the upper lid.
- Pour out all the remaining water in the tank from the DRAIN SIDE.
- Put a few drops of neutral kitchen detergent into warm water and clean the product with a soft rag.
- If the unit happens to be knocked over or tipped during operation, please shake the unit to drain the water inside the mechanism and put it in a well-ventilated place for natural drying.

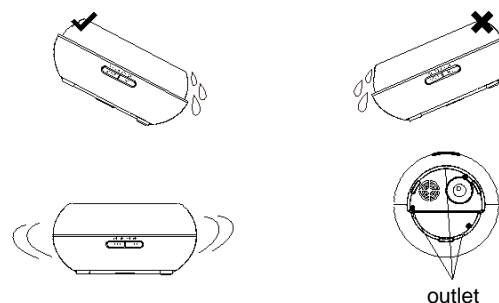

Aroma Diffuser

User Manual

### Essential Oil Recipes

#### Balancing Blends

**Balancing Blends**  
Add following oils to diffuser and enjoy:  
2 drops of Geranium Oil  
2 drops of Rose Absolute Oil  
2 drops of Clary Sage Oil

#### Mind Ease

Add following oils to diffuser and enjoy:  
3 drops of Lavender Oil  
3 drops of Peppermint Oil  
3 drops of Chamomile Oil

#### Relaxing Blends

**Peace of Mind**  
Add following oils to diffuser and enjoy:  
7-8 drops of Lavender Oil  
4-6 drops of Chamomile Oil

#### Romance Blends

**Love is in the Air**  
Add following oils to diffuser and enjoy:  
1 drop of Patchouli Oil  
3 drops of Jasmine Absolute Oil  
3-5 drops of Geranium Oil

#### Energizing

Add following oils to diffuser and enjoy:  
1 drop of Peppermint Oil  
1 drop of Rosemary Oil  
2 drops of Cinnamon Leaf Oil

#### Calming Night

Add following oils to diffuser and enjoy:  
3-4 drops of Cypress Oil  
3-4 drops of Lavender Oil  
3-4 drops of Marjoram Oil

#### Things are Just Rosy

Add following oils to diffuser and enjoy:  
1 drop of Geranium Oil  
10-12 drops of Rose Absolute Oil

Aroma Diffuser

User Manual

#### Purifying Blends

**Purifying Room**  
Add following oils to diffuser and enjoy:  
1 drop of Tea Tree Oil  
1 drop of Grapefruit Oil  
7-8 drops of Lemon Oil

#### Uplifting Blends

**Orange You Delightful**  
Add following oils to diffuser and enjoy:  
7-8 drops of Orange Oil  
17-20 drops of Vanilla Concentrate Oil

#### Spring Cleaning

Add following oils to diffuser and enjoy:  
7-8 drops of Lemongrass Oil  
3-5 drops of Lemon Oil  
1 drop of Eucalyptus Oil

### After-sale Service

This product is guaranteed for 12 months from the date of purchase, please contact us if you need a replacement/refund. Email: support@innogear.net

Phone: 800-806-3008

Follow us on Facebook



www.facebook.com/InnoGear.net

Scan QR code to watch our video which shows you how to use the diffuser.



www.innogear.net/  
200ml-wood-diffuser-video-guide

Aroma Diffuser