



# Epson® SureColor® T-Series

Precision. Performance. Brilliance

2<sup>nd</sup> Generation Product Preview

**EPSON®**

*Built to Perform.*

# t-series

24 | 36 | 44

## The Product Line

SureColor T-Series



**SureColor T3270 - 24"**  
Single-Roll

**SureColor T5270 - 36"**  
Single-Roll

**SureColor T7270 - 44"**  
Single-Roll

**SureColor T5270D - 36"**  
Dual-Roll

**SureColor T7270D - 44"**  
Dual-Roll



**Multifunction Module**  
Scanner, Stand, HDD

**SureColor T5270 - 36"**  
Single-Roll + MFP Module

**SureColor T7270 - 44"**  
Single-Roll + MFP Module

**SureColor T5270D - 36"**  
Dual-Roll + MFP Module

**SureColor T7270D - 44"**  
Dual-Roll + MFP Module

Optional Multifunction Scanner Module can be added at time of purchase or in the future as your business needs grow.



# Product Features

Epson SureColor T-Series

**Roll and Sheet Feeder**

Three Widths available 24", 36" and 44"

**Thick Media Print Path**

Handles rigid media up to 1.5 mm thick

**Optional 36" Multifunction Scanner**

High Performance Scan & Copy Functionality

**Optional Expansion Modules**

- Adobe® Postscript® 3™ Hardware Engine
- Internal 320 GB Printer Server

**Redesigned Catch Basket**

Horizontal Output Stacking Basket Design

**Optional Take-up Reel System**

Available for SC-T7270 Model Only



Available in 24", 36" and 44" Widths



Available in 36" and 44" Widths

## Optional Multifunction Scanner Module

All New Development by Epson

### Versatile Support for Handling Originals

From thin newspaper up to 1.3 mm thick rigid media

### 36" In-line CIS Image Sensor

Captures fine color detail at up to 600 dpi

### Dual Low-angle Lighting

Creates clean copies and scanned images from creased or folded originals

### Alloy Scanner Stand

Securely attaches to the printer's stand

### Internal Print Server Included

320 GB Storage Capacity

### Modular Design

Multifunction Module can be added at any time



### ■ Best-In-Class Performance<sup>1</sup>

- Color D-Size (22" x 34") Copy under 40 seconds
- Color Scan Speeds up to 6-inches per second

### ■ Optimized Image Quality

- Enhance fine detail and remove unwanted background for crisp clean images
- Preset modes from Line Drawings to Photographic Posters

### ■ Intuitive Controls

- Auto Copy Enlargement to fit media, or scalable from 25 to 400%
- Selectable output resolution from 200 dpi to 600 dpi
- Save images in either JPEG or PDF file formats



1. Scan speed of 6-inches per second based on scanning at 200 dpi in 24-bit RGB color. Copy speed based on time from start of copy process (360 dpi speed mode) until printing is completed including cutting of the paper.



## Optional Multifunction Scanner Module

Remotely Control the SureColor T-Series



Control Copy, Scan, Preview, and Share features remotely from a mobile device



Copy, Scan and Share

### Collaborative Sharing

Share copies and scanned images easily and quickly between workgroups directly from the SureColor T-Series Multifunction systems

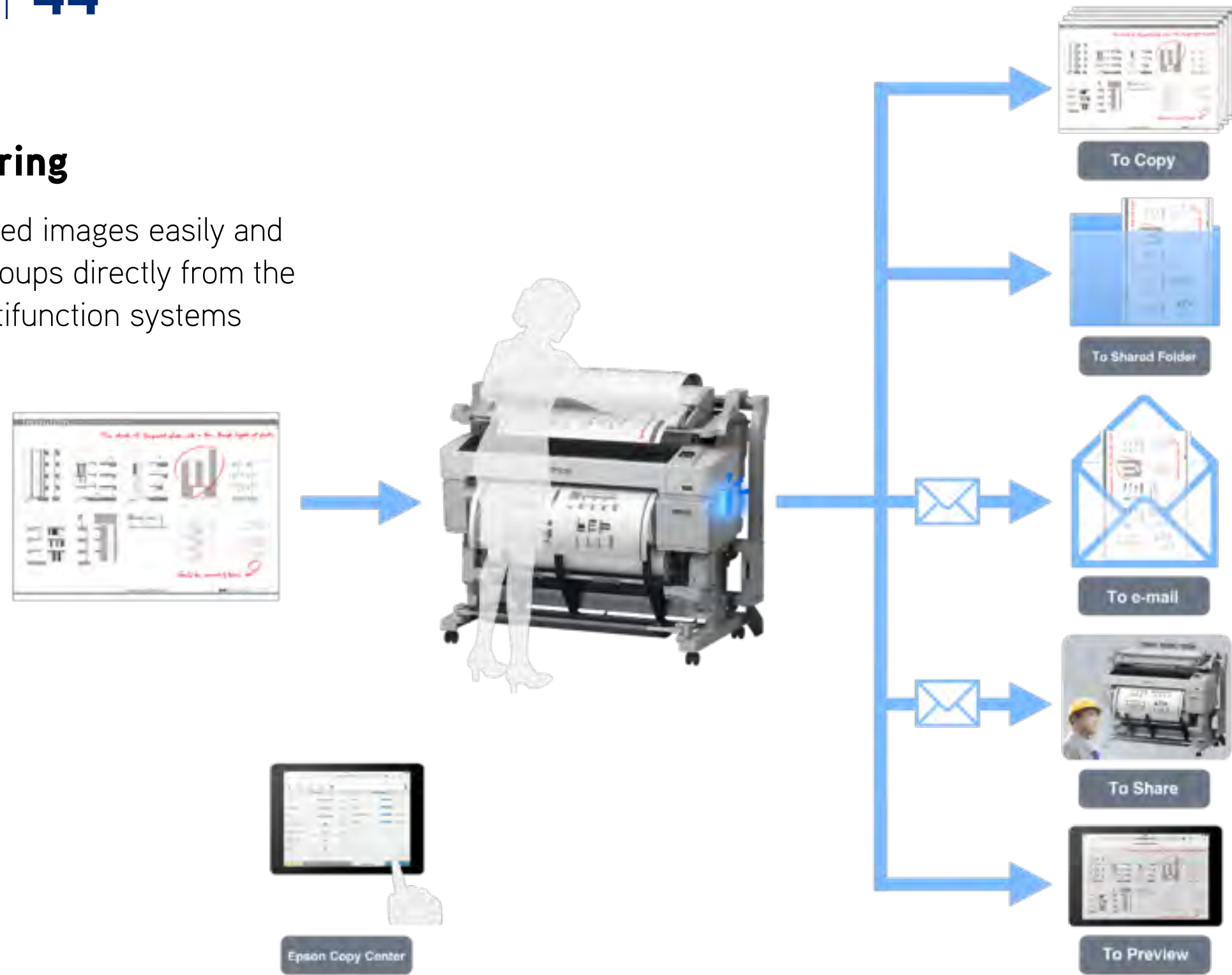

### ■ Internal Print Server

- Boost Workgroup Productivity
- Remotely Manage Print Queues
- Save and Reprint Jobs with 320 GB Capacity

### ■ True Adobe® Postscript® 3™ Hardware Engine

- Direct / Hot-Folder Batch Printing
- Support for Secure PDF Printing
- Fastest In-Class Postscript Engine
- *Includes the Internal Print Server Hardware listed above*



#### Internal Print Server

320GB Capacity  
**\$399.95** MSRP



#### Adobe® PostScript® 3™

320GB Capacity  
**\$1,199.95** MSRP

Expansion Modules can be added at time of purchase or in the future as your business needs grow.

# Product Features

## Front Loading Inks



### Simple Front-Loading Ink Cartridges

5-Color configuration including Cyan, Yellow, Magenta, Matte Black, and Photo Black  
Available in three fill sizes – 110 ml, 350 ml, or 700 ml

You can mix-and-match different sizes for each color

### Epson UltraChrome® XD Inks

Specially formulated pigmented ink delivers brilliant color and crisp lines on virtually any paper type, as well as being truly archival and extremely smudge and water-resistant

The SureColor T-Series printers are designed to be used exclusively with these specially-formulated inks, and not with other brands of cartridges or inks



# Product Features

Easy-to-Use Interface

## Error Status Lamp

Easy to notice from across a large space

## Full Color LCD Panel

Simple Icon-based interface

## Simple Button Layout

The most used actions have their own buttons

### ■ Roll Media Adapters Adjust for both 2-inch and 3-inch Roll Media Cores

- Simple Tension Lever Ensures Quick and Secure Media Core Loading
- Extremely Fast Roll Media Loading with Less Chance of Media Damage
- Designed with Epson ePlaten™ Technology for Highly-Accurate Roll Media Loading

intuitive.  
design

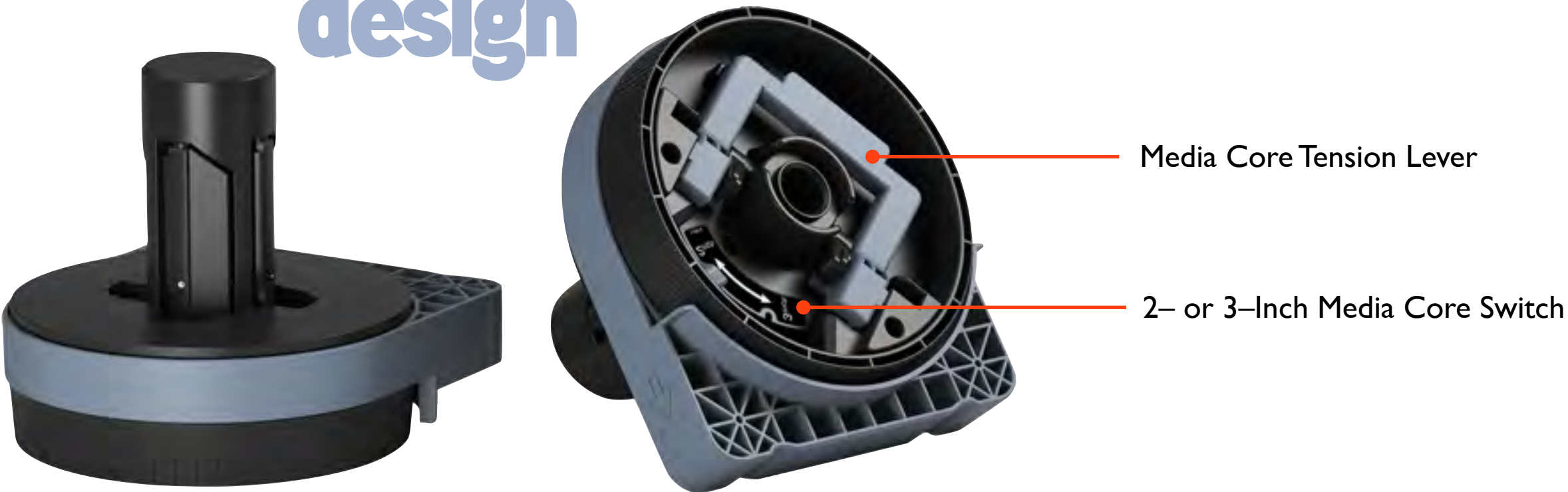

### ■ In-Printer eMail Notification Technology

- If your SureColor T-Series printer is connected to an internet network, you can enable automatic eMail notifications to an active eMail or text eMail address
- Notifications include Job Finished, Error Status, Low Ink Remaining, and more
- No special software or computer required - the printer handles everything

automatic  
email alerts





# Epson PrecisionCore™

Next-Generation Print Head Technology





### ■ All-New High-Density Print Chip Core

- Advanced Thin Film Piezo (TFP) print chip core is only 1/1,000 mm thin
- Precision dot control for extreme print clarity and sharpness
- By utilizing more advanced piezo materials, a higher-level of print head durability is achieved

### ■ High-Precision MEMS Manufacturing Process

- Based on the Micro-Electro-Mechanical Systems process for an unparalleled level of manufacturing efficiency for consistent production quality

### ■ Outstanding Ink Flexibility

- The PrecisionCore print chip is capable of printing with a wide-range of ink types

### ■ Scalable Print Performance

- The PrecisionCore chip, delivers commercial-grade performance in a compact, modular form, and enables Epson to scale the technology, from single-pass industrial presses, to professional and consumer printers.



exotic  
print head  
technology



### ■ Extreme Print Quality

- Capable of print resolutions up to 2,880 x 1,440 dpi
- Precision ink drop control for outstanding clarity and sharpness

### ■ Fast Print Speeds

- True 720 dpi per color channel per single pass
- Quite possibly one of the fastest printers in its class

### ■ Commercial Grade Reliability

- Developed for use with Epson UltraChrome XD aqueous inks for high reliability
- Capable of high-volume printing with very little downtime for maintenance



# Print Performance

Epson SureColor T-Series

**EPSON®**

*Built to Perform.*

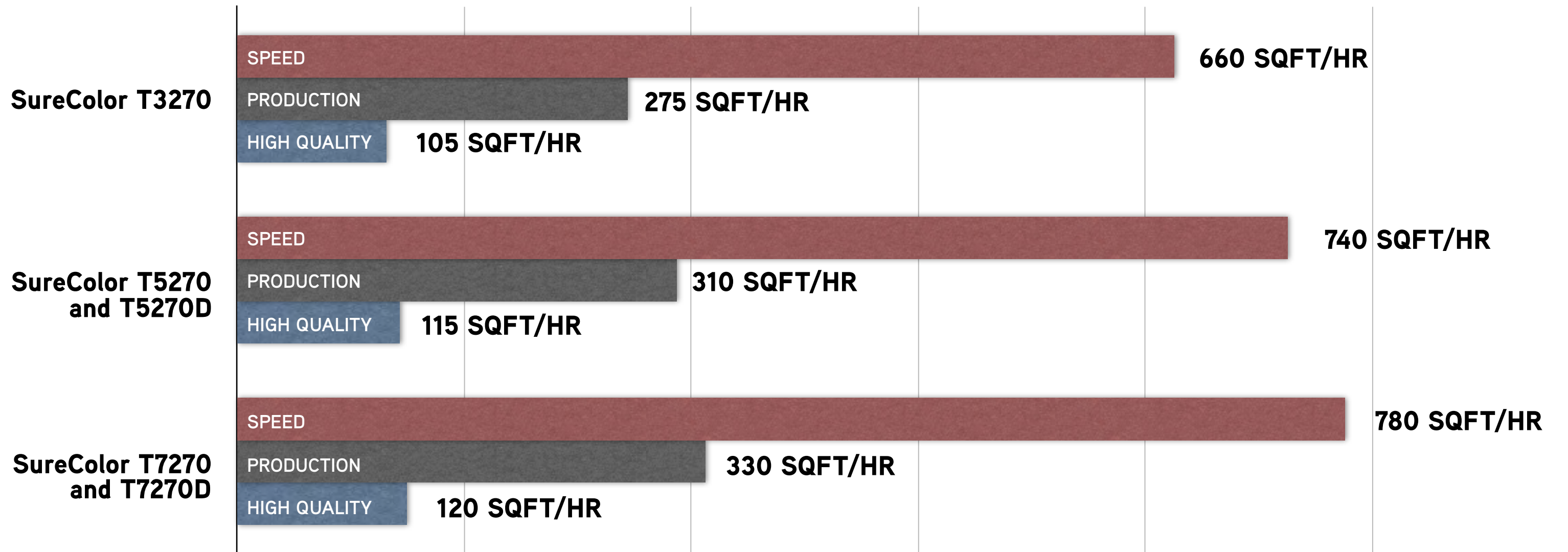

Square Feet Per Hour

Print speeds for square feet per hour are based on print engine speed only. Total throughput time for any print depends on workstation configuration, file size, print resolution, ink coverage, networking, etc.



# Epson Warranty & Service Programs

Award Winning Service & Support

award winning  
service  
support

### ■ Standard Epson Preferred<sup>SM</sup> Limited Warranty

- One-year on-site service
- Includes free phone support available Monday thru Friday
- Usually next business day on-site break fix service
- Warranty includes parts and labor

### ■ Optional Extended Epson Preferred Plus Plans

- Extends coverage when the in-box warranty ends
- Additional warranty coverage plans available for up to a total of 3 years



### Engineering Scientific

- Extreme Print & Copy Speeds
- Plotting Precision
- Brilliant Photographic Prints
- Low Cost-of-Ownership
- Waterproof Plots
- Future Expandable Design
- Robust Printer Design
- World-class Service & Support

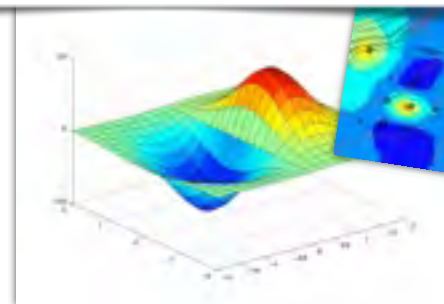
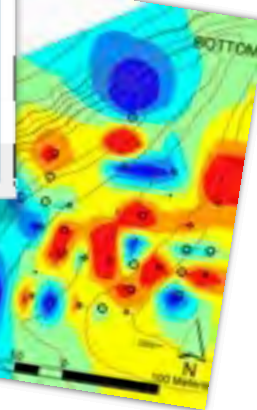
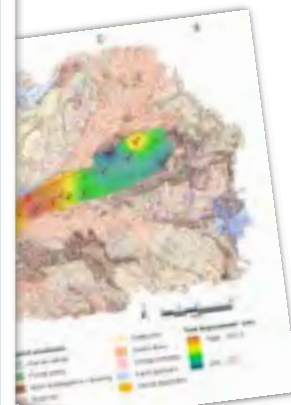

### Business Graphics

- Simple to Use
- Brilliant Photographic Posters
- Vivid Color for Bold Graphics
- Saves You Money!
- No More Waiting for Prints
- Virtually Zero Maintenance
- Amazing Print Durability
- World-class Service & Support

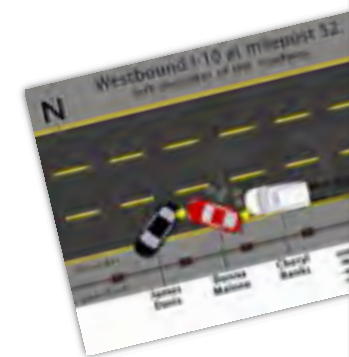

### ■ The Fastest Speeds in its Class

- As little as 25 seconds for a D-size Color Print, and 40 seconds for D-size Color Copy<sup>1</sup>

### ■ Extremely Precise Output

- Capable of accurately plotting minimum line widths as thin as 0.018 mm
- Advanced color screening technology designed to produce true continuous-tone photo printing rivaling traditional six-color printers

### ■ High Print Durability & Archivability

- UltraChrome XD pigment-based ink is archival, and extremely smudge and water-resistant

### ■ Scalable for the Future

- *Optional* Multifunction Scanner, Adobe® Postscript® 3™, and an Internal Print Server
- Most Extensive Product Line - Single Roll, Dual Roll, Multifunction, and Postscript

### ■ Low Cost-of-Ownership

- Large capacity ink cartridges up to 700 ml per color for low printing costs

1. Print speeds for a single page are based on print engine speed only. For D-size prints the T3270 prints slightly slower than the T5270 and T7270. Total throughput time for any print depends on workstation configuration, file size, print resolution, ink coverage, networking, etc. Copy speed based on time from start of copy process (360 dpi speed mode) until printing is completed including cutting of the paper.

precision  
output







**Specifications are Subject to Change Without Notice**

Epson, Epson UltraChrome, PrecisionCore, SureColor, and TFP are trademarks or registered trademarks and EPSON Exceed Your Vision is a registered logo mark of Seiko Epson Corp. Adobe and PostScript are either registered trademarks or trademarks of Adobe Systems Incorporated in the United States and/or other countries.

All other product brand names are trademarks and/or registered trademarks of their respective companies.

Epson disclaims any and all rights to these trademarks.

© Epson America, Inc. 2014 TC 07.12.2014