

**LYNDEX
NIKKEN** 

TAPER PLUS TOOL HOLDERS

Taper and Flange Contact Toolholders

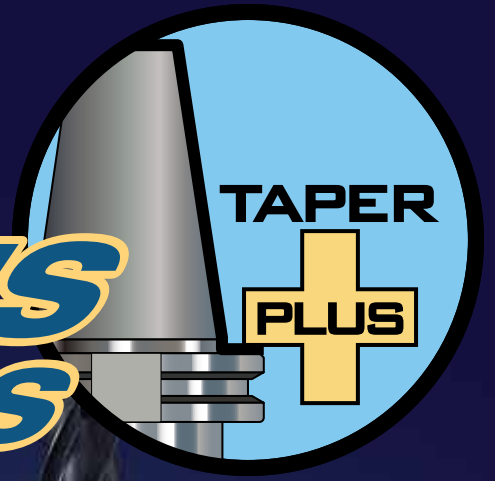

***Dual Contact holders for high
precision and higher rigidity!***

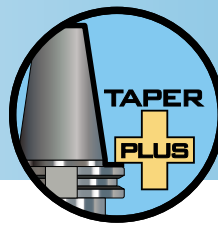

TAPER PLUS: COMBINING TAPER ACCURACY WITH FLANGE RIGIDITY!



- Outstanding Runout Accuracy for longer tool life
- Vibration Dampening for increased productivity
- High Rigidity for smooth and stable cutting

Standard 7/24 taper spindle

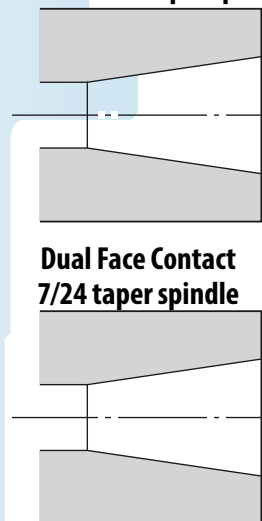

Dual Face Contact
7/24 taper spindle

Taper Plus Toolholder

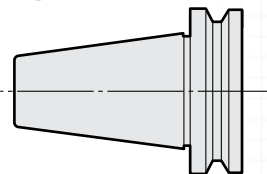

**Taper Plus Toolholders
are interchangeable
between Standard and
Dual Face Contact spindles
for greater flexibility!**

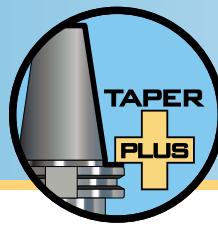

Runout Accuracy



High Quality Taper Grinding:

Ground to an AT2 standard, holding a .003 degree angular taper variation, and maintaining a diameter tolerance of 24-40 millionths of an inch to ensure the highest surface contact between the spindle and the toolholder taper and flange.



Vibration Dampening and High Rigidity

CAT/BT Dual Face Contact Spindle + Taper Plus Toolholder

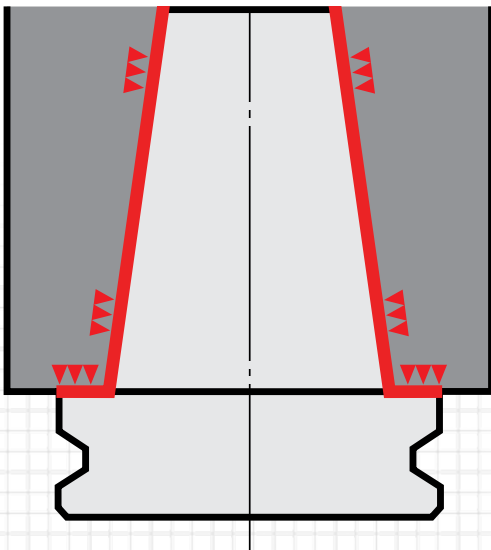

The Power of the Dampening Effect:

Taper and Flange Contact establishes 53.3% more surface area contact than just the taper alone, creating a dampening effect that eliminates chatter and vibration. With the additional flange contact becoming a supportive cantilever, cutting rigidity is highly improved.

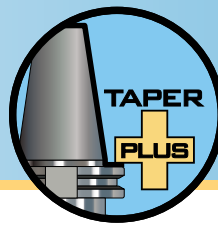

Milling Chuck Features

THE MOST RELIABLE AND POWERFUL TOOLHOLDER

- The Original:** US Patent (7018919) - Nikken Japan is the inventor of the Milling Chuck.
- Stable Heavy Milling:** High strength Nickel Chromium Molybdenum 4340 alloy. Solid 1-piece base and thick wall design ensure no distortion during heavy machining.
- High Runout Accuracy:** Within 0.0002" at 4" from the nose guaranteed.
- Even Gripping:** Clamping along the entire shank is a key condition for precise milling. Only Nikken Taper Plus Milling Chucks clamp even at 3mm from the nose. This is ideal for roughing and finishing.



Forged Nickel Chrome Molybdenum 4340 ground on taper and base.



Thick nut exerts immense gripping strength by collapsing tight taper on the mill chuck body.



Staggered, coated steel cage packs 140% more needle rollers than imitations. This provides more gripping power. The retainer is NOT made of phosphor bronze but rather of special steel which will never break.

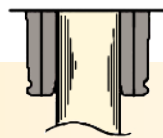

**NIKKEN
MILLING CHUCK**

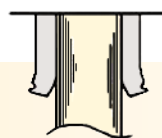

**OTHER
MILLING CHUCKS**



HIGH RUNOUT ACCURACY:

Within 0.0002" at 3.75" from the nose guaranteed!
Flange and taper grinding allow for smooth and precise chucking of tool, resulting in minimal TIR.

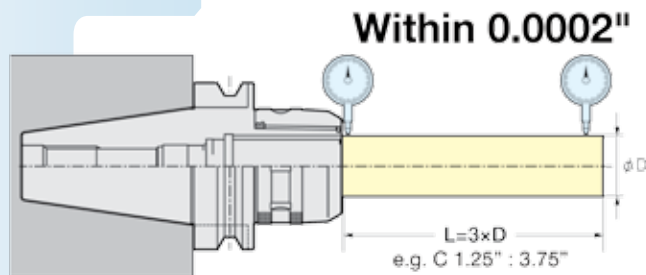

SUB-ZERO TREATMENT (-90°C)

All milling chucks are cryogenically treated after heat treatment to remove residual Austenite. This creates a uniform Martensite state and eliminates warpage and distortion, preventing deformation during the life of the toolholder.

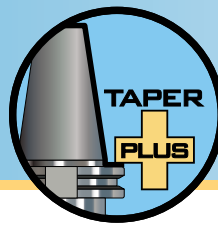

Milling Chuck Collet System

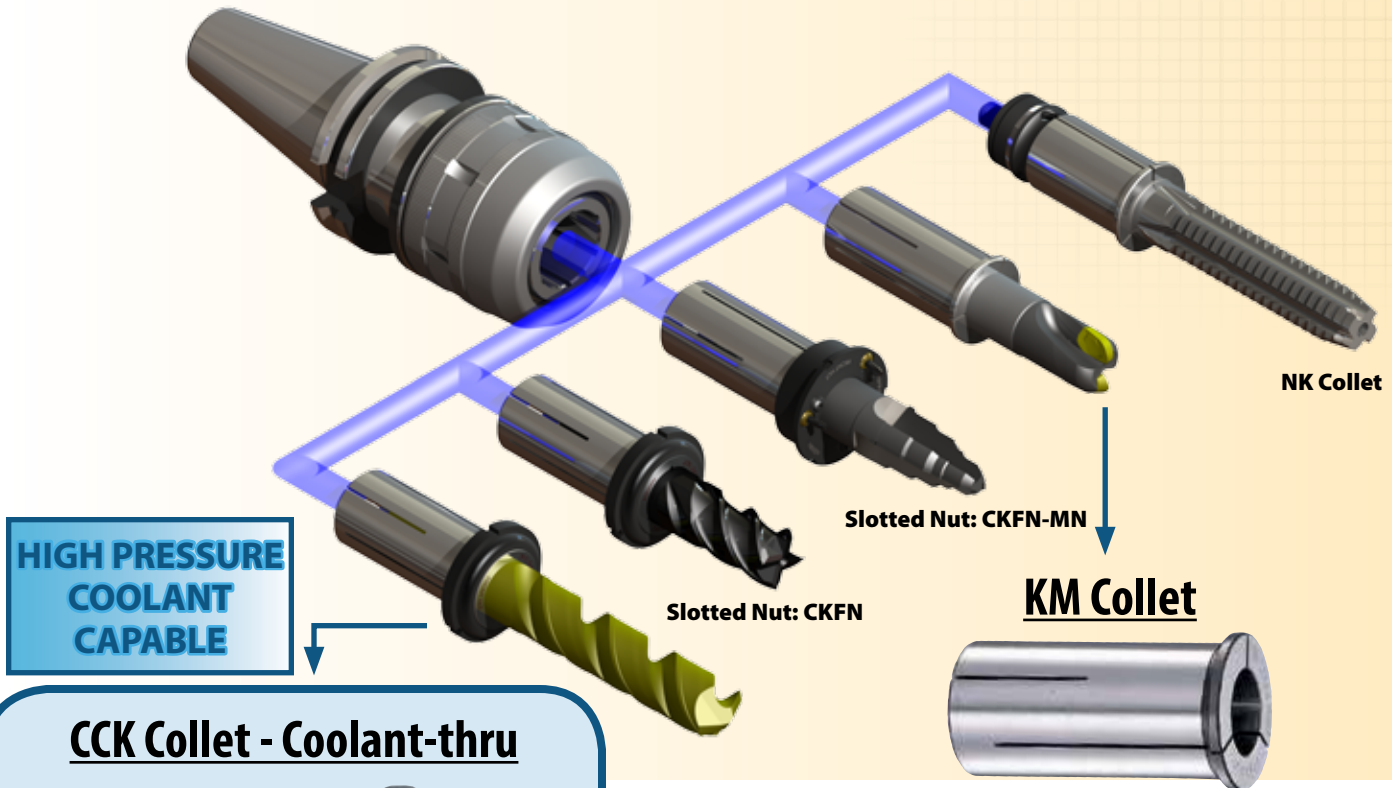

CCK Collet - Coolant-thru



- High pressure coolant application through existing slots
- CCK reduction collets offers flexibility to hold both metric and inch standard shanks
- Straight collet design eliminates taper tolerance variation between mating surfaces
- Many options available to configure how coolant is expelled
- CCK collets are designed with an internal coolant groove that helps channel high pressure coolant to the periphery of your cutter without any reduction of gripping strength and TIR accuracy



- High precision KM reduction collets extend the chucking flexibility of the milling chuck. All inch and metric standard sizes can be held by the same toolholder
- Can be used in conjunction with a coolant back up screw for high pressure (1200 PSI) applications

EXAMPLES OF COOLANT-THRU OPTIONS

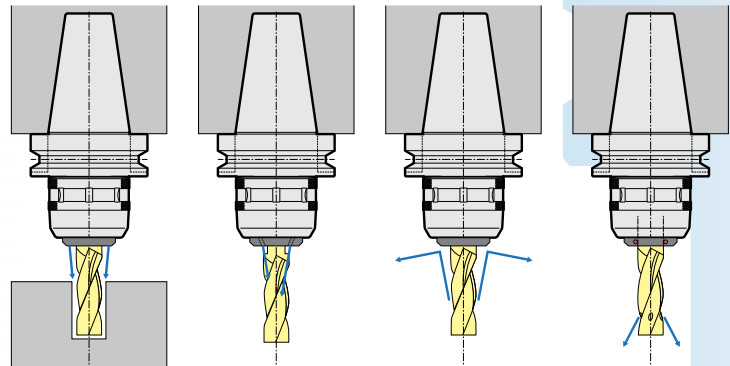

For Grooving

For cutters with cutting diameters larger than the shank diameter

Prevention of swarf contamination

Front seal with O-ring seal used with coolant-thru cutter, is also available as an option

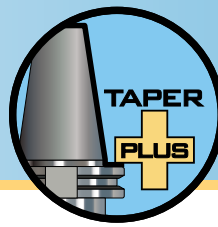

Hi-Torque ER Collet Chuck Features

LYNDEX-NIKKEN

Ground surface allows perpendicular contact of retention stud, ensuring better alignment.

AT3 or better taper contact: .0028 degree tolerance variation 80 millionths to 126 millionths. Traverse ground taper ensures 80% or better taper contact.

Body of Collet Chuck equal in diameter to the nut diameter. Thicker diameter and wall thickness results in stronger rigidity.

Reduced gap size to prevent birds nests and other stringy chips from packing in or wrapping about.

ER Bearing, Ground Eccentric Nut: Smooth nut prevents coolant flare and provides better balance.

2x the gripping force than other brands!

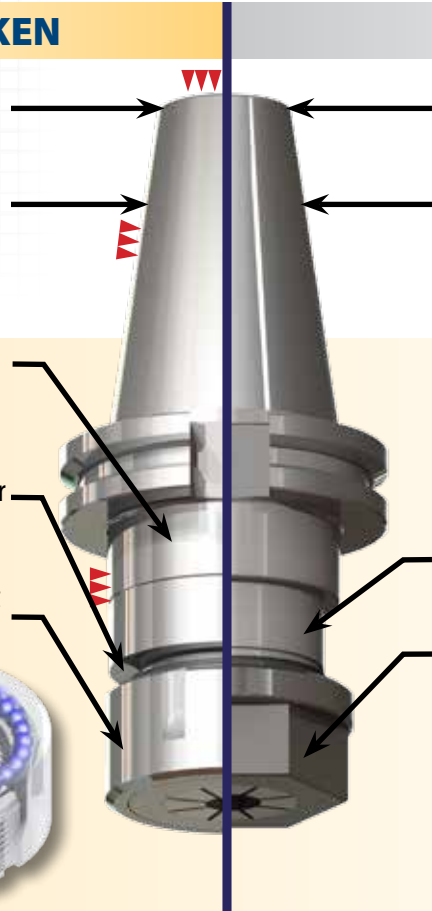
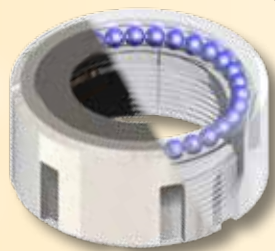

OTHER

Turned rough surface causes the retention stud centerline to deviate.

AT4 or better taper contact: .0028 degree tolerance variation 80 millionths to 126 millionths. Plunge ground taper creates inconsistency, ensuring only 60% or better taper contact.

Recessed collet chuck body diameter weakens rigidity of holder.

Large hex nut body design flares coolant away from toolholder.

HIGHER GRIPPING FORCE + TAPER PLUS = GREATER CHIP REMOVAL!

- Precision ground bearing nut for additional gripping force (nut included as standard)
- Machine with higher chip load and reduce cycle time

- Better overall cutting condition
- Reduction in end mill pulling reduces scrapping parts
- Eliminate over tightening that can lead to collet damage and excessive run-out

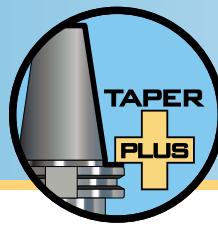

MMC Collet Chuck Features

ACCURACY IN SMALL DIAMETER CUTTING

- Slim:** Slim and compact body for precision machining with small diameter tools (up to 0.5").
- Accurate:** Precision ground and pre-balanced, ensuring accuracy during high-speed operations.
- Versatile:** Most flexible for machining Die Mold, Aerospace, and Medical parts by providing both clearance and accuracy.
- High-Speed, High Precision:** Max. 30,000 RPM (balanced at G2.5).
- High Runout Accuracy:** Within 0.00012" at 4 times the diameter of the cutting tool! This produces better stability and improves surface finish.



**HIGH PRESSURE
COOLANT
CAPABLE**

Easy-to-use draw-in collet clamping mechanism: clamp/unclamp just with a wrench!

Standard type Mini-Mini Collet Chuck

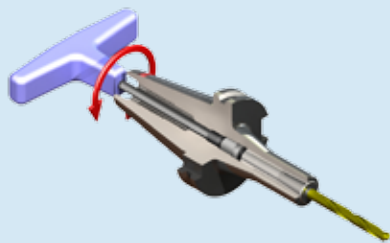

"A" type Mini-Mini Collet Chuck



Coolant-thru Capabilities:

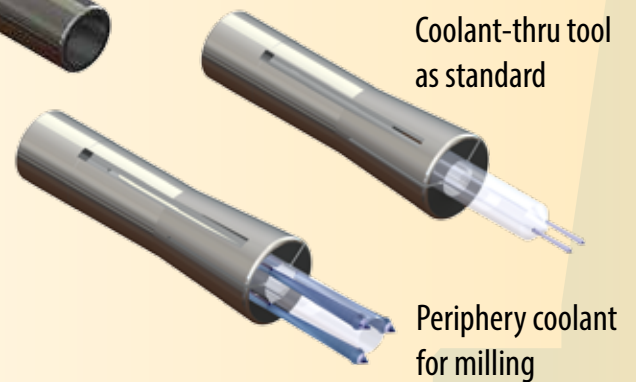

SLIM, COMPACT NOSE AND FRONT CLAMPING

No collet nut required! An internal draw-in collet clamping mechanism results in strong, high-precision gripping and allows for a slim nose that can access hard to reach areas.

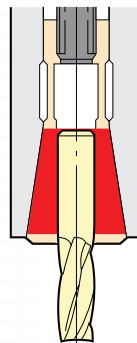

Slim and compact nose with strong gripping at nose

- MMC 4: Ø 15mm
- MMC 8: Ø 20mm
- MMC 12: Ø 30mm

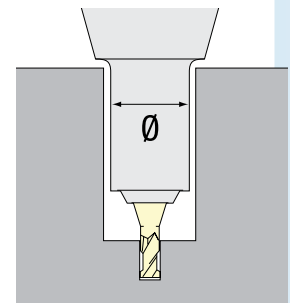

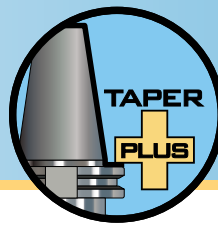

VC Collet Chuck Features

ULTRA PERFORMANCE

- Extremely Precise:** 0.00012" or less concentricity guarantee with any collet
- Extremely Efficient:** Ideal for high-speed machining, thread milling, ultra precision reaming
- Flexible:** Covers sizes from 0.079" to 0.5"
- Extremely Accurate:** Twice more accurate than a ER collet chuck, with 10 times better repeatability
- 8° versus 16° collet taper:** Twice more gripping power than ER Collet Chucks
- High Runout Accuracy:** Within 0.00012" at 4 times the diameter of the cutting tool! This produces better stability and improves surface finish.



HIGH RUNOUT ACCURACY:

Within 0.00012" at 4 times the diameter of the cutting tool! This produces better stability and improves surface finish.

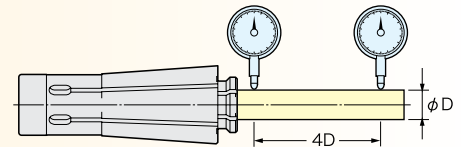

**HIGH PRESSURE
COOLANT
CAPABLE**

Coolant-thru Capabilities:

High Pressure
Coolant-thru Tool

Periphery High
Pressure Coolant

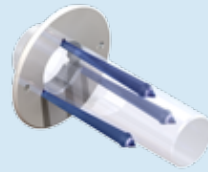
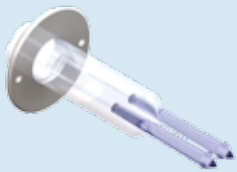

VC Collet Range:



VCK6: 2-6mm (1/8"-1/4")
VCK13: 3-12mm (1/8"-1/2")

VC Collet vs. Others:



VCK Collet

- Runout: 0.00012"
- 170N.m gripping power



ER Collet

- Runout: 0.0001"
- 80N.m gripping power



TG Collet

- Runout: 0.0003"
- 100N.m gripping power

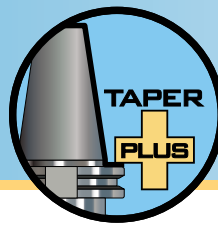

SK Collet Chuck Features

LEAN, TOUGH AND EFFICIENT

- Lean:** Narrow body design accesses tight spots
- Versatile:** Applicable for all milling, drilling, reaming and rigid tapping applications
- Flexible:** Covers sizes from .027" to 1"
- Accurate:** Two times more accurate than ER Collet Chucks, within 10 times better repeatability
- Extremely Precise:** 0.00012" or less concentricity guarantee with on-size collets all the time
- Extremely Successful:** Over 1 million SK Collet Chucks and 15 million SK collets sold worldwide



HIGH RUNOUT ACCURACY:

Nikken guarantees a 3 micron runout tolerance for their "on size" fractional and metric size precision collets due to Nikken's special heat treatment, grinding and custom slotting process.

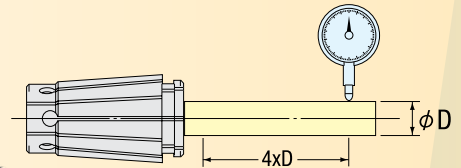

**HIGH PRESSURE
COOLANT
CAPABLE**

Superior SK Coolant System

Coolant-thru Disc:
A perfect seal is formed around cutting tool shank when paired with Coolant Nut

Slotted Disc:
When paired with the Coolant Nut, coolant is directed to the cutting edge of the cutting tool, making this combination ideal for non-coolant-thru tools.



INCREASED GRIPPING POWER:

Our steep 8° collet seats deeper in the body of the holder, providing 2x more gripping power than traditional 16° ER collets.

SK Collet Range:

			
SK6 (0.7-6.0mm - 0.027-0.236")	SK10 (1.75-10.0mm - 0.069-0.393")	SK16 (2.75-16.0mm - 0.108-0.629")	SK25 (16.0-25.4mm - 0.629-1.000")

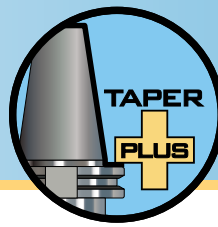

End Mill Holder Features

EXTREME RIGIDITY

Featuring the highest taper contact and high quality steel, our End Mill Holders provide extreme rigidity for even the heaviest machining applications.

Shank style available from stock: CAT, BT, HSK, NMTB, and Straight, with inch or metric bores. High rigidity, stubby style, extended lengths and Aerospace whistle notch End Mill Holders also available.



*Aerospace
End Mill Holder*

Aerospace End Mill Holders

Lyndex-Nikken Aerospace End Mill Holders are field tested and proven to prevent the end mill from pullout, unlike other's holders.

Unique Design and Built-in Features

- End Mill Holder bore does not exceed 0.0002" beyond nominal dimension
- Dual support screws to secure depth adjustment screw and side lock screw
- Tapped fine 2B internal threads for precision adjustment
- AT3 taper grind to match the grind tolerance of your machine spindle
- Balanced for high-speed machining (up to 18,000 RPM)
- Made from high quality 4340 Nickel Chrome Molybdenum Heat Treated Japanese Steel
- End Mill Holder must be used with 5 degree whistle notch cutter (NAS 987)

Our Aerospace End Mill Holders will help you produce aerospace parts with greater accuracy and efficiency.

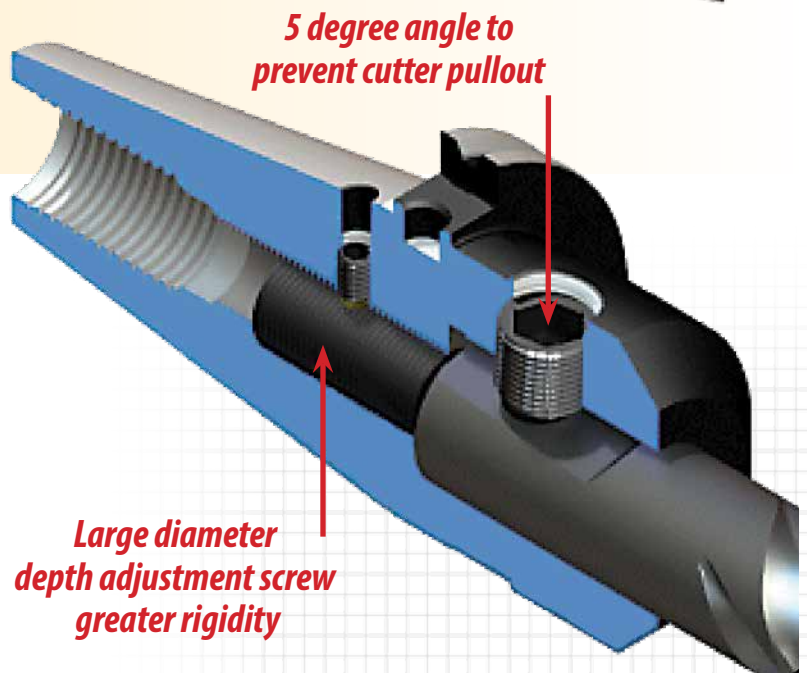

*5 degree angle to
prevent cutter pullout*

*Large diameter
depth adjustment screw
greater rigidity*

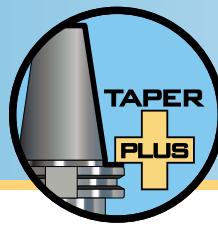

Shrink Fit Holder Features

HIGH ACCURACY WITH OPTIMAL CLEARANCE

- Accuracy:** Shrink fit holders provide minimal run out (within .0001" run out at the nose of toolholder).
- Gripping Force:** Interference fit between cutting tool and holder provide extreme gripping force.
- Clearance:** Ideal for all applications where clearance can be an issue
- High Speed: Balanced:** up to 30,000 RPM for high speed machining applications.



Shrink Fit Holder

Unique Design and Built-in Features

- All shrink fit tools are made from the highest quality tool steel (H11 tool steel, at HRc 52)
- Holders can shrink Carbide, HSS, and Powder Metal cutting tools
- Available with coolant ports to help evacuate chips
- Can be used with non-Lyndex-Nikken Shrink Fit machines



- Shrinking capability of \varnothing 2mm to \varnothing 40mm (.079" - 1.575")
- Light weight and compact- Shrink machine unit net weight -19kg (41.9 lbs.)
- Shrink unit can shrink/ unshrink holders up to 12.5" gage lengths

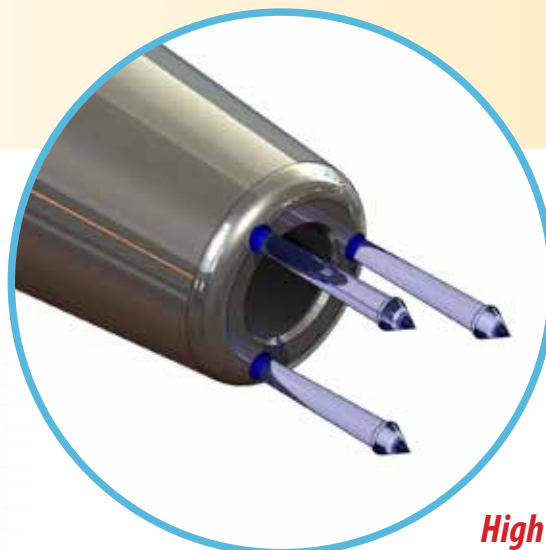

High pressure coolant ports

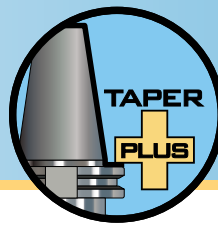
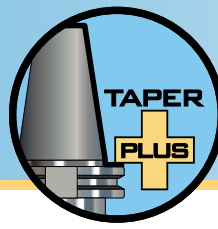
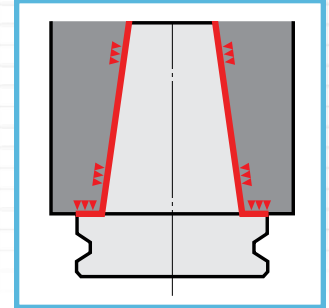
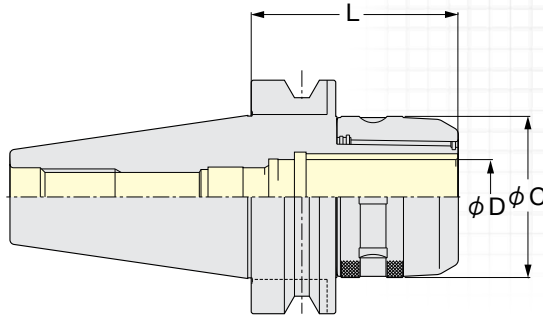

TABLE OF CONTENTS

<u>Milling Chucks</u>	<u>Pg. 13</u>	<u>SK Coolant Collet System</u>	<u>Pg. 35</u>
<u>High Speed Milling Chucks</u>	<u>Pg. 14</u>	<u>SK Collet Chuck Accessories</u>	<u>Pg. 36</u>
<u>KM & CCK Collets</u>	<u>Pg. 15</u>	<u>End Mill Holders</u>	<u>Pg. 37</u>
<u>Hi-Torque ER Collet Chucks</u>	<u>Pg. 16</u>	<u>End Mill Accessories</u>	<u>Pg. 38</u>
<u>ER16 Collets</u>	<u>Pg. 17</u>	<u>FMD - Face/Shell Mill Holder</u>	<u>Pg. 39</u>
<u>ER20 Collets</u>	<u>Pg. 18</u>	<u>CAT40 Shrink Fit Holders</u>	<u>Pg. 40</u>
<u>ER25 Collets</u>	<u>Pg. 19</u>	<u>CAT50 Shrink Fit Holders</u>	<u>Pg. 41</u>
<u>ER32 Collets</u>	<u>Pg. 20</u>	<u>BT30/40 Shrink Fit Holders</u>	<u>Pg. 42</u>
<u>ER40 Collets</u>	<u>Pg. 21</u>	<u>BT50 Shrink Fit Holders</u>	<u>Pg. 43</u>
<u>MMC Collet Chucks</u>	<u>Pg. 22</u>	<u>Shrinking Equipment</u>	<u>Pg. 44</u>
<u>MPK4 & VMK8 Collets</u>	<u>Pg. 22</u>	<u>Shrink Fit Accessories</u>	<u>Pg. 45-46</u>
<u>VC6 Collet Chucks</u>	<u>Pg. 23</u>		
<u>VCK6 Collets</u>	<u>Pg. 23</u>		
<u>VC13 Collet Chucks</u>	<u>Pg. 24</u>		
<u>VCK13 Collets</u>	<u>Pg. 24</u>		
<u>SK6 Collet Chucks</u>	<u>Pg. 25</u>		
<u>SK10 Collet Chucks</u>	<u>Pg. 26</u>		
<u>SK16 Collet Chucks</u>	<u>Pg. 27</u>		
<u>SK25 Collet Chucks</u>	<u>Pg. 28</u>		
<u>SK6-P Collet Chucks</u>	<u>Pg. 29</u>		
<u>SK10-P Collet Chucks</u>	<u>Pg. 30</u>		
<u>SK16-P & SK25-P Collet Chucks</u>	<u>Pg. 31</u>		
<u>SK Collets</u>	<u>Pg. 32-34</u>		



Milling Chucks



Part Number	Collet Series	Wrench	Clamping Range	D	L	C
-------------	---------------	--------	----------------	---	---	---

CAT 40

NCAT40-C3/4-70U-IDU	KM3/4 or CCK3/4	9HC22	0.125 - 0.750"	0.750"	2.756"	2.047"
NCAT40-C3/4-105U-IDU	KM3/4 or CCK3/4	9HC22	0.125 - 0.750"	0.750"	4.134"	2.047"
NCAT40-C3/4-120U-IDU	KM3/4 or CCK3/4	9HC22	0.125 - 0.750"	0.750"	4.724"	2.047"
NCAT40-C1-85U-IDU	KM1 or CCK1	9HC25	0.125 - 1.000"	1.000"	3.346"	2.362"
NCAT40-C1-105U-IDU	KM1 or CCK1	9HC25	0.125 - 1.000"	1.000"	4.134"	2.362"
NCAT40-C1.1/4SL-85U-IDU	KM1.1/4 or CCK1.1/4	9HC32	0.187 - 1.250"	1.250"	3.346"	2.717"
NCAT40-C1.1/4SL-105U-IDU	KM1.1/4 or CCK1.1/4	9HC32	0.187 - 1.250"	1.250"	4.134"	2.717"
NCAT40-C1.1/4SL-120U-IDU	KM1.1/4 or CCK1.1/4	9HC32	0.187 - 1.250"	1.250"	4.724"	2.717"

CAT 50

NCAT50-C3/4-105U	KM3/4 or CCK3/4	9HC22	0.125 - 0.750"	0.750"	4.134"	2.047"
NCAT50-C3/4-135U	KM3/4 or CCK3/4	9HC22	0.125 - 0.750"	0.750"	5.315"	2.047"
NCAT50-C3/4-165U	KM3/4 or CCK3/4	9HC22	0.125 - 0.750"	0.750"	6.496"	2.047"
NCAT50-C1-105U-IDU	KM1 or CCK1	9HC25	0.125 - 1.000"	1.000"	4.134"	2.362"
NCAT50-C1-135U	KM1 or CCK1	9HC25	0.125 - 1.000"	1.000"	5.315"	2.362"
NCAT50-C1.1/4-90U	KM1.1/4 or CCK1.1/4	9HC32	0.187 - 1.250"	1.250"	3.543"	2.717"
NCAT50-C1.1/4-105U	KM1.1/4 or CCK1.1/4	9HC32	0.187 - 1.250"	1.250"	4.134"	2.717"
NCAT50-C1.1/4-135U	KM1.1/4 or CCK1.1/4	9HC32	0.187 - 1.250"	1.250"	5.315"	2.717"
NCAT50-C2-105U	KM2 or CCK2	9HC50	1.000 - 2.000"	2.000"	4.134"	4.134"

BT 30

NBT30-C3/4-75	KM3/4 or CCK3/4	9HC22	0.125 - 0.750"	0.750"	2.953"	2.047"
---------------	-----------------	-------	----------------	--------	--------	--------

BT 40

NBT40-C3/4-70	KM3/4 or CCK3/4	9HC22	0.125 - 0.750"	0.750"	2.756"	2.047"
NBT40-C1-70	KM1 or CCK1	9HC25	0.125 - 1.000"	1.000"	2.756"	2.362"
NBT40-C1-90	KM1 or CCK1	9HC25	0.125 - 1.000"	1.000"	3.543"	2.362"
NBT40-C1.1/4-85	KM1.1/4 or CCK1.1/4	9HC32	0.187 - 1.250"	1.250"	3.346"	2.717"
NBT40-C1.1/4-120	KM1.1/4 or CCK1.1/4	9HC32	0.187 - 1.250"	1.250"	4.724"	2.717"

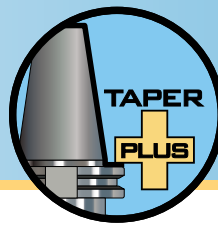

High Speed Milling Chucks

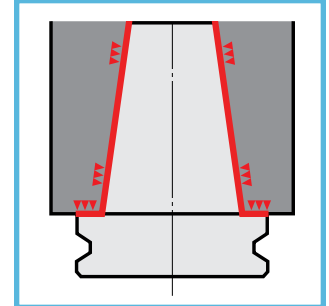
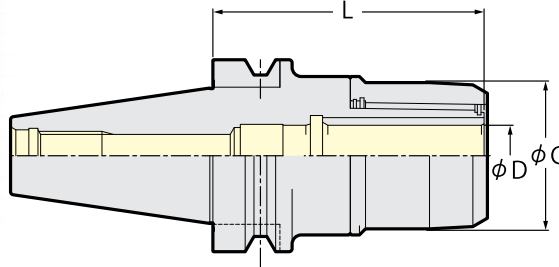

Part Number	Collet Series	Wrench	Clamping Range	D	L	C
-------------	---------------	--------	----------------	---	---	---

CAT 40

NCAT40-C3/4-70UG	KM3/4 or CCK3/4	GH20	0.125 - 0.750"	0.750"	2.756"	1.890"
NCAT40-C3/4-105UG	KM3/4 or CCK3/4	GH20	0.125 - 0.750"	0.750"	4.134"	1.890"
NCAT40-C3/4-120UG	KM3/4 or CCK3/4	GH20	0.125 - 0.750"	0.750"	4.724"	1.890"
NCAT40-C1-85UG	KM1 or CCK1	GH25	0.125 - 1.000"	1.000"	3.346"	2.165"
NCAT40-C1-105UG	KM1 or CCK1	GH25	0.125 - 1.000"	1.000"	4.134"	2.165"
NCAT40-C1.1/4SL-85UG	KM1.1/4 or CCK KM1.1/4	GH32	0.187 - 1.250"	1.250"	3.346"	2.677"
NCAT40-C1.1/4SL105UG	KM1.1/4 or CCK KM1.1/4	GH32	0.187 - 1.250"	1.250"	4.134"	2.677"
NCAT40-C1.1/4SL120UG	KM1.1/4 or CCK KM1.1/4	GH32	0.187 - 1.250"	1.250"	4.724"	2.677"

CAT 50

NCAT50-C3/4-105UG	KM3/4 or CCK3/4	GH20	0.125 - 0.750"	0.750"	4.134"	1.890"
NCAT50-C3/4-135UG	KM3/4 or CCK3/4	GH20	0.125 - 0.750"	0.750"	5.315"	1.890"
NCAT50-C1-105UG	KM1 or CCK1	GH25	0.125 - 1.000"	1.000"	4.134"	2.165"
NCAT50-C1-135UG	KM1 or CCK1	GH25	0.125 - 1.000"	1.000"	5.315"	2.165"
NCAT50-C1.1/4-90UG	KM1.1/4 or CCK KM1.1/4	GH32	0.187 - 1.250"	1.250"	3.543"	2.677"
NCAT50-C1.1/4-105UG	KM1.1/4 or CCK KM1.1/4	GH32	0.187 - 1.250"	1.250"	4.134"	2.677"
NCAT50-C1.1/4-135UG	KM1.1/4 or CCK KM1.1/4	GH32	0.187 - 1.250"	1.250"	5.315"	2.677"

BT 30

NBT30-C3/4-75G	KM3/4 or CCK3/4	GH20	0.125 - 0.750"	0.750"	2.953"	1.890"
NBT30-C1-75G	KM1 or CCK1	GH25	0.125 - 1.000"	1.000"	2.953"	2.165"
NBT30-C1.1/4-100G	KM1.1/4 or CCK KM1.1/4	GH32	0.187 - 1.250"	1.250"	3.937"	1.890"

BT 40

NBT40-C3/4-70G	KM3/4 or CCK3/4	GH20	0.125 - 0.750"	0.750"	2.756"	1.890"
NBT40-C1-70G	KM1 or CCK1	GH25	0.125 - 1.000"	1.000"	2.756"	2.165"
NBT40-C1-90G	KM1 or CCK1	GH25	0.125 - 1.000"	1.000"	3.543"	2.165"
NBT40-C1.1/4-85G	KM1.1/4 or CCK KM1.1/4	GH32	0.187 - 1.250"	1.250"	3.346"	2.677"
NBT40-C1.1/4-120G	KM1.1/4 or CCK KM1.1/4	GH32	0.187 - 1.250"	1.250"	4.724"	2.677"

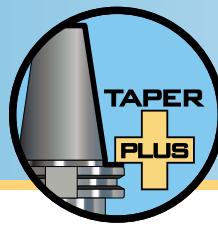

KM 3/4 Collet-Inch and Metric

Size	Collet Number
1/8"	KM3/4-1/8
3/16"	KM3/4-3/16
1/4"	KM3/4-1/4
5/16"	KM3/4-5/16
3/8"	KM3/4-3/8
7/16"	KM3/4-7/16
1/2"	KM3/4-1/2
9/16"	KM3/4-9/16
5/8"	KM3/4-5/8
6.0mm	KM3/4-6
7.0mm	KM3/4-7
8.0mm	KM3/4-8
10.0mm	KM3/4-10
12.0mm	KM3/4-12
14.0mm	KM3/4-14
16.0mm	KM3/4-16

CCK 3/4 Collet-Inch and Metric

Size	Collet Number	Coolant Thru Nut	Slotted Nut	Disc Wrench
1/8"	CCK3/4-1/8	CKFN3/4-1/8C	CKFN3/4-1/8	CCKL20
3/16"	CCK3/4-3/16	CKFN3/4-3/16C	CKFN3/4-3/16	
1/4"	CCK3/4-1/4	CKFN3/4-1/4C	CKFN3/4-1/4	
5/16"	CCK3/4-5/16	CKFN3/4-5/16C	CKFN3/4-5/16	
3/8"	CCK3/4-3/8	CKFN3/4-3/8C	CKFN3/4-3/8	
7/16"	CCK3/4-7/16	CKFN3/4-7/16C	CKFN3/4-7/16	
1/2"	CCK3/4-1/2	CKFN3/4-1/2C	CKFN3/4-1/2	
9/16"	CCK3/4-9/16	CKFN3/4-9/16C	CKFN3/4-9/16	
5/8"	CCK3/4-5/8	CKFN3/4-5/8C	CKFN3/4-5/8	
6.0mm	CCK3/4-6	CKFN3/4-6C	CKFN3/4-6	
7.0mm	CCK3/4-7	CKFN3/4-7C	CKFN3/4-7	
8.0mm	CCK3/4-8	CKFN3/4-8C	CKFN3/4-8	
10.0mm	CCK3/4-10	CKFN3/4-10C	CKFN3/4-10	
12.0mm	CCK3/4-12	CKFN3/4-12C	CKFN3/4-12	
14.0mm	CCK3/4-14	CKFN3/4-14C	CKFN3/4-14	
16.0mm	CCK3/4-16	CKFN3/4-16C	CKFN3/4-16	



CCK Collet



CCK Collet Nut

KM 1 Collet-Inch and Metric

Size	Collet Number
1/8"	KM1-1/8
3/16"	KM1-3/16
1/4"	KM1-1/4
5/16"	KM1-5/16
3/8"	KM1-3/8
7/16"	KM1-7/16
1/2"	KM1-1/2
9/16"	KM1-9/16
5/8"	KM1-5/8
3/4"	KM1-3/4
7/8"	KM1-7/8
6.0mm	KM1-6
7.0mm	KM1-7
8.0mm	KM1-8
10.0mm	KM1-10
12.0mm	KM1-12
14.0mm	KM1-14
16.0mm	KM1-16
18.0mm	KM1-18
20.0mm	KM1-20

CCK 1 Collet-Inch and Metric

Size	Collet Number	Coolant Thru Nut	Slotted Nut	Disc Wrench
1/8"	CCK1-1/8	CKFN1-1/8C	CKFN1-1/8	CCKL25
3/16"	CCK1-3/16	CKFN1-3/16C	CKFN1-3/16	
1/4"	CCK1-1/4	CKFN1-1/4C	CKFN1-1/4	
5/16"	CCK1-5/16	CKFN1-5/16C	CKFN1-5/16	
3/8"	CCK1-3/8	CKFN1-3/8C	CKFN1-3/8	
7/16"	CCK1-7/16	CKFN1-7/16C	CKFN1-7/16	
1/2"	CCK1-1/2	CKFN1-1/2C	CKFN1-1/2	
9/16"	CCK1-9/16	CKFN1-9/16C	CKFN1-9/16	
5/8"	CCK1-5/8	CKFN1-5/8C	CKFN1-5/8	
3/4"	CCK1-3/4	CKFN1-3/4C	CKFN1-3/4	
7/8"	CCK1-7/8	CKFN1-7/8C	CKFN1-7/8	
6.0mm	CCK1-6	CKFN1-6C	CKFN1-6	
7.0mm	CCK1-7	CKFN1-7C	CKFN1-7	
8.0mm	CCK1-8	CKFN1-8C	CKFN1-8	
10.0mm	CCK1-10	CKFN1-10C	CKFN1-10	
12.0mm	CCK1-12	CKFN1-12C	CKFN1-12	
14.0mm	CCK1-14	CKFN1-14C	CKFN1-14	
16.0mm	CCK1-16	CKFN1-16C	CKFN1-16	
18.0mm	CCK1-18	CKFN1-18C	CKFN1-18	
20.0mm	CCK1-20	CKFN1-20C	CKFN1-20	



CCK Collet with Nut



KM Collet

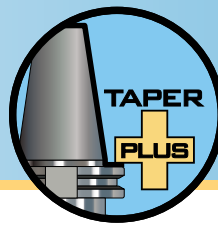

Hi-Torque ER Collet Chucks

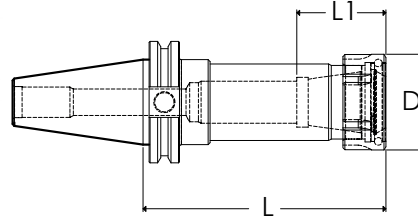

Back-up screw is included

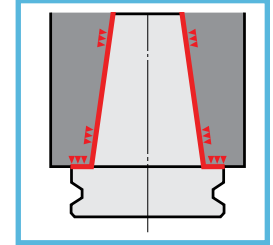

Part Number	Collet Size	Nut Wrench	Collet Range	L	L1	D
-------------	-------------	------------	--------------	---	----	---

CAT 40

NC4007-0016-3.50	ER16	016-SPAN	.019-.406"	3.50"	0.87"	1.26"
NC4007-0020-2.50	ER20	020-SPAN	.039-.511"	2.50"	1.06"	1.38"
NC4007-0025-2.50	ER25	025-SPAN	.039-.629"	2.50"	1.18"	1.65"
NC4007-0032-3.13	ER32	032-SPAN	.078-.787"	3.13"	1.34"	1.97"
NC4007-0040-3.13	ER40	040-SPAN	.118-1.023"	3.13"	1.50"	2.48"
NC4017-0016-6.00	ER16	016-SPAN	.019-.406"	6.00"	0.87"	1.26"
NC4017-0020-4.00	ER20	020-SPAN	.039-.511"	4.00"	1.06"	1.38"
NC4017-0025-4.00	ER25	025-SPAN	.039-.629"	4.00"	1.18"	1.65"
NC4017-0032-5.00	ER32	032-SPAN	.078-.787"	5.00"	1.34"	1.97"

CAT 50

NC5007-0016-4.12	ER16	016-SPAN	.019-.406"	4.12"	0.87"	1.26"
NC5007-0032-4.00	ER32	032-SPAN	.078-.787"	4.00"	1.34"	1.97"
NC5007-0040-4.00	ER40	040-SPAN	.118-1.023"	4.00"	1.50"	2.48"
NC5017-0016-6.00	ER16	016-SPAN	.019-.406"	6.00"	0.87"	1.26"
NC5017-0020-4.00	ER20	020-SPAN	.039-.511"	4.00"	1.06"	1.38"
NC5017-0025-4.00	ER25	025-SPAN	.039-.629"	4.00"	1.18"	1.65"
NC5017-0032-6.00	ER32	032-SPAN	.078-.787"	6.00"	1.34"	1.97"

BT 30

NB3007-0008-2.00	ER8	08-NASPAN	.019-.196"	2.00"	0.51"	0.47"
NB3017-0008-4.00	ER8	08-NASPAN	.019-.196"	4.00"	0.51"	0.47"
NB3007-0011-2.00	ER11	011-HEX	.019-.275"	2.00"	0.65"	0.75"
NB3017-0011-4.00	ER11	011-HEX	.019-.275"	4.00"	0.65"	0.75"
NB3007-0016-2.36	ER16	016-SPAN	.019-.406"	2.36"	0.87"	1.26"
NB3017-0016-4.00	ER16	016-SPAN	.019-.406"	4.00"	0.87"	1.26"
NB3027-0016-5.00	ER16	016-SPAN	.019-.406"	5.00"	0.87"	1.26"
NB3037-0016-6.00	ER16	016-SPAN	.019-.406"	6.00"	0.87"	1.26"
NB3057-0020-1.22	ER20	020-SPAN	.039-.511"	1.22"	1.57"	1.10"
NB3007-0020-2.50	ER20	020-SPAN	.039-.511"	2.50"	1.06"	1.38"
NB3017-0020-4.00	ER20	020-SPAN	.039-.511"	4.00"	1.06"	1.38"
NB3007-0025-2.00	ER25	025-SPAN	.039-.629"	2.00"	1.18"	1.65"
NB3017-0025-4.00	ER25	025-SPAN	.039-.629"	4.00"	1.18"	1.65"
NB3007-0032-3.00	ER32	032-SPAN	.078-.787"	3.00"	1.34"	1.97"
NB3017-0032-5.00	ER32	032-SPAN	.078-.787"	5.00"	1.34"	1.97"

ER COLLET DIMENSIONAL DATA

Style	D	D1	L	Collet Range	Coolant Collet Size Range
ER16	17.2mm	11.3mm	27.0mm	0.5mm - 10.0mm	4.0mm - 10.0mm (3/16" - 17/64")
ER20	21.2mm	14.5mm	31.0mm	1.0mm - 13.0mm	5.0mm - 13.0mm (5/32" - 1/2")
ER25	26.2mm	18.5mm	35.0mm	1.0mm - 16.0mm	6.0mm - 16.0mm (7/32" - 5/8")
ER32	33.2mm	24.4mm	40.0mm	2.0mm - 20.0mm	10.0mm - 20.0mm (1/4" - 25/32")
ER40	41.2mm	31.2mm	46.0mm	3.0mm - 26.0mm	10.0mm - 26.0mm (1/4" - 1.02")

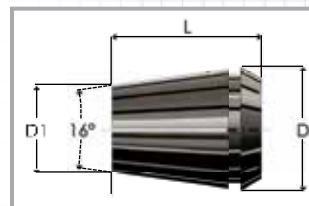

ER Coolant Collets with high pressure coolant-thru the tool capability are available. Mechanical sealing design eliminates the need for discs, special nuts, or wrenches. See ER Coolant Collets on pages 16 - 20.

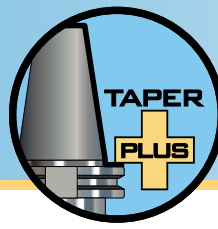

ER16 Collets



Our patented Coolant Collets are designed for use with cylindrical shank tools (no flats). Cutting tool should be inserted the full length of the collet. If these conditions are not met, coolant leakage may result. Seals up to maximum coolant pressure of 1000PSI.

Size Range: 1/32"-13/32"

INCH		
Part Number	Size	Collapse Range
E16-002	1/32"	.031" - .027"
E16-004	1/16"	.063" - .047"
E16-006	3/32"	.094" - .078"
-	7/64"	-
E16-008	1/8"	.125" - .109"
-	9/64"	-
E16-010	5/32"	.156" - .125"
-	11/64"	-
E16-012	3/16"	.187" - .156"
-	13/64"	-
E16-014	7/32"	.219" - .187"
-	15/64"	-
E16-016	1/4"	.250" - .219"
-	17/64"	-
E16-018	9/32"	.281" - .250"
-	19/64"	-
E16-020	5/16"	.312" - .281"
-	21/64"	-
E16-022	11/32"	.344" - .312"
-	23/64"	-
E16-024	3/8"	.375" - .344"
-	25/64"	-
E16-026	13/32"	.406" - .375"

Size range: 1.0mm - 10.0mm (0.039"-0.393")

METRIC		
Part Number	Size	Collapse Range
E16-039	1.0mm	1.0mm-0.5mm
E16-059	1.5mm	1.5mm-1.0mm
E16-078	2.0mm	2.0mm-1.5mm
E16-098	2.5mm	2.5mm-2.0mm
E16-118	3.0mm	3.0mm-2.5mm
E16-137	3.5mm	3.5mm-3.0mm
E16-157	4.0mm	4.0mm-3.5mm
E16-177	4.5mm	4.5mm-4.0mm
E16-196	5.0mm	5.0mm-4.5mm
E16-216	5.5mm	5.5mm-5.0mm
E16-236	6.0mm	6.0mm-5.5mm
E16-255	6.5mm	6.5mm-6.0mm
E16-275	7.0mm	7.0mm-6.5mm
E16-295	7.5mm	7.5mm-7.0mm
E16-314	8.0mm	8.0mm-7.5mm
E16-334	8.5mm	8.5mm-8.0mm
E16-354	9.0mm	9.0mm-8.5mm
E16-374	9.5mm	9.5mm-9.0mm
E16-393	10.0mm	10.0mm-9.5mm

Size Range: 3/32"-13/32"

INCH-COOLANT-THRU		
Part Number	Size	Collapse Range
E16-006(C)	3/32"	.094" - .089"
E16-007(C)	7/64"	.109" - .105"
E16-008(C)	1/8"	.125" - .121"
E16-009(C)	9/64"	.140" - .136"
E16-010(C)	5/32"	.156" - .152"
E16-011(C)	11/64"	.171" - .167"
E16-012(C)	3/16"	.187" - .183"
E16-013(C)	13/64"	.203" - .199"
E16-014(C)	7/32"	.219" - .203"
E16-015(C)	15/64"	.234" - .219"
E16-016(C)	1/4"	.250" - .234"
E16-017(C)	17/64"	.266" - .250"
E16-018(C)	9/32"	.281" - .266"
E16-019(C)	19/64"	.297" - .281"
E16-020(C)	5/16"	.312" - .297"
E16-021(C)	21/64"	.328" - .312"
E16-022(C)	11/32"	.344" - .328"
E16-023(C)	23/64"	.359" - .344"
E16-024(C)	3/8"	.375" - .359"
E16-025(C)	25/64"	.391" - .375"
E16-026(C)	13/32"	.406" - .391"

Size range: 4.0mm-10.0mm (0.157"-0.393")

METRIC-COOLANT-THRU		
Part Number	Size	Collapse Range
E16-157(C)	4.0mm	4.0mm - 3.5mm
E16-177(C)	4.5mm	4.5mm - 4.0mm
E16-196(C)	5.0mm	5.0mm - 4.5mm
E16-216(C)	5.5mm	5.5mm - 5.0mm
E16-236(C)	6.0mm	6.0mm - 5.5mm
E16-255(C)	6.5mm	6.5mm - 6.0mm
E16-275(C)	7.0mm	7.0mm - 6.5mm
E16-295(C)	7.5mm	7.5mm - 7.0mm
E16-314(C)	8.0mm	8.0mm - 7.5mm
E16-334(C)	8.5mm	8.5mm - 8.0mm
E16-354(C)	9.0mm	9.0mm - 8.5mm
E16-374(C)	9.5mm	9.5mm - 9.0mm
E16-393(C)	10.0mm	10.0mm - 9.5mm

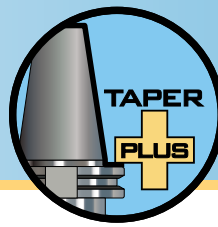

ER20 Collets

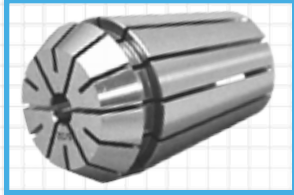

Our patented Coolant Collets are designed for use with cylindrical shank tools (no flats). Cutting tool should be inserted the full length of the collet. If these conditions are not met, coolant leakage may result. Seals up to maximum coolant pressure of 1000PSI.

Size Range: 1/16"-1/2"

INCH		
Part Number	Size	Collapse Range
E20-004	1/16"	.063" - .047"
E20-006	3/32"	.094" - .078"
E20-008	1/8"	.125" - .109"
E20-010	5/32"	.156" - .125"
-	11/64"	-
E20-012	3/16"	.187" - .156"
-	13/64"	-
E20-014	7/32"	.219" - .187"
-	15/64"	-
E20-016	1/4"	.250" - .219"
-	17/64"	-
E20-018	9/32"	.281" - .250"
-	19/64"	-
E20-020	5/16"	.312" - .281"
-	21/64"	-
E20-022	11/32"	.344" - .312"
-	23/64"	-
E20-024	3/8"	.375" - .344"
-	25/64"	-
E20-026	13/32"	.406" - .375"
-	27/64"	-
E20-028	7/16"	.437" - .406"
-	29/64"	-
E20-030	15/32"	.469" - .437"
-	31/64"	-
E20-032	1/2"	.500" - .469"

**Size range: 1.0mm - 13.0mm
(0.039"-0.511")**

METRIC		
Part Number	Size	Collapse Range
E20-078	2.0mm	2.0mm-1.0mm
E20-118	3.0mm	3.0mm-2.5mm
E20-137	3.5mm	3.5mm-2.5mm
E20-157	4.0mm	4.0mm-3.5mm
-	4.5mm	-
E20-196	5.0mm	5.0mm-4.0mm
-	5.5mm	-
E20-236	6.0mm	6.0mm-5.0mm
-	6.5mm	-
E20-275	7.0mm	7.0mm-6.0mm
-	7.5mm	-
E20-314	8.0mm	8.0mm-7.0mm
-	8.5mm	-
E20-354	9.0mm	9.0mm-8.0mm
-	9.5mm	-
E20-393	10.0mm	10.0mm-9.0mm
-	10.5mm	-
E20-433	11.0mm	11.0mm-10.0mm
E20-452	11.5mm	11.5mm-11.0mm
E20-472	12.0mm	12.0mm-11.0mm
-	12.5mm	-
E20-511	13.0mm	13.0mm-12.0mm

Size Range: 5/32"-1/2"

INCH-COOLANT-THRU		
Part Number	Size	Collapse Range
E20-010(C)	5/32"	.156" - .152"
E20-011(C)	11/64"	.172" - .167"
E20-012(C)	3/16"	.187" - .183"
E20-013(C)	13/64"	.203" - .199"
E20-014(C)	7/32"	.219" - .203"
E20-015(C)	15/64"	.234" - .219"
E20-016(C)	1/4"	.250" - .234"
E20-017(C)	17/64"	.266" - .250"
E20-018(C)	9/32"	.281" - .266"
E20-019(C)	19/64"	.297" - .281"
E20-020(C)	5/16"	.312" - .297"
E20-021(C)	21/64"	.328" - .312"
E20-022(C)	11/32"	.344" - .328"
E20-023(C)	23/64"	.359" - .344"
E20-024(C)	3/8"	.375" - .359"
E20-025(C)	25/64"	.391" - .375"
E20-026(C)	13/32"	.406" - .391"
E20-027(C)	27/64"	.422" - .406"
E20-028(C)	7/16"	.437" - .422"
E20-029(C)	29/64"	.453" - .437"
E20-030(C)	15/32"	.469" - .453"
E20-031(C)	31/64"	.484" - .469"
E20-032(C)	1/2"	.500" - .484"

**Size range: 5.0mm-13.0mm
(0.196"-0.511")**

METRIC-COOLANT-THRU		
Part Number	Size	Collapse Range
E20-196(C)	5.0mm	5.0mm - 4.5mm
E20-216(C)	5.5mm	5.5mm - 5.0mm
E20-236(C)	6.0mm	6.0mm - 5.5mm
E20-255(C)	6.5mm	6.5mm - 6.0mm
E20-275(C)	7.0mm	7.0mm - 6.5mm
E20-295(C)	7.5mm	7.5mm - 7.0mm
E20-314(C)	8.0mm	8.0mm - 7.5mm
E20-334(C)	8.5mm	8.5mm - 8.0mm
E20-354(C)	9.0mm	9.0mm - 8.5mm
E20-374(C)	9.5mm	9.5mm - 9.0mm
E20-393(C)	10.0mm	10.0mm - 9.5mm
E20-413(C)	10.5mm	10.5mm - 10.0mm
E20-433(C)	11.0mm	11.0mm - 10.5mm
E20-452(C)	11.5mm	11.5mm - 11.0mm
E20-472(C)	12.0mm	12.0mm - 11.5mm
E20-492(C)	12.5mm	12.5mm - 12.0mm
E20-511(C)	13.0mm	13.0mm - 12.5mm

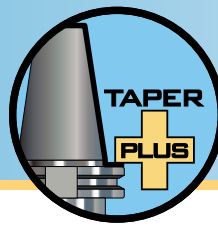

ER25 Collets



Our patented Coolant Collets are designed for use with cylindrical shank tools (no flats). Cutting tool should be inserted the full length of the collet. If these conditions are not met, coolant leakage may result. Seals up to maximum coolant pressure of 1000PSI.

Size Range: 1/16" - 5/8"

INCH		
Part Number	Size	Collapse Range
E25-004	1/16"	.063" - .047"
E25-006	3/32"	.094" - .078"
E25-008	1/8"	.125" - .109"
E25-010	5/32"	.156" - .125"
E25-012	3/16"	.187" - .156"
E25-014	7/32"	.218" - .187"
-	15/64"	-
E25-016	1/4"	.250" - .219"
-	17/64"	-
E25-018	9/32"	.281" - .250"
-	19/64"	-
E25-020	5/16"	.312" - .281"
-	21/64"	-
E25-022	11/32"	.344" - .312"
-	23/64"	-
E25-024	3/8"	.375" - .344"
-	25/64"	-
E25-026	13/32"	.406" - .375"
-	27/64"	-
E25-028	7/16"	.437" - .406"
-	29/64"	-
E25-030	15/32"	.469" - .437"
-	31/64"	-
E25-032	1/2"	.500" - .469"
-	33/64"	-
E25-034	17/32"	.531" - .500"
-	35/64"	-
E25-036	9/16"	.563" - .531"
-	37/64"	-
E25-038	19/32"	.594" - .563"
-	39/64"	-
E25-040	5/8"	.625" - .594"

Size range: 1.0mm - 16.0mm (0.039"-0.629")

METRIC		
Part Number	Size	Collapse Range
E25-078	2.0mm	2.0mm-1.0mm
E25-118	3.0mm	3.0mm-2.0mm
E25-137	3.5mm	3.5mm-2.5mm
E25-157	4.0mm	4.0mm-3.0mm
E25-196	5.0mm	5.0mm-4.0mm
E25-236	6.0mm	6.0mm-5.0mm
E25-275	7.0mm	7.0mm-6.0mm
E25-314	8.0mm	8.0mm-7.0mm
E25-354	9.0mm	9.0mm-8.0mm
E25-393	10.0mm	10.0mm-9.0mm
E25-433	11.0mm	11.0mm-10.0mm
E25-452	11.5mm	11.5mm-11.0mm
E25-472	12.0mm	12.0mm-11.0mm
E25-511	13.0mm	13.0mm-12.0mm
E25-551	14.0mm	14.0mm-13.0mm
E25-590	15.0mm	15.0mm-14.0mm
E25-629	16.0mm	16.0mm-15.0mm

Size Range: 7/32" - 5/8"

INCH-COOLANT-THRU		
Part Number	Size	Collapse Range
E25-014(C)	7/32"	.219" - .203"
E25-015(C)	15/64"	.234" - .219"
E25-016(C)	1/4"	.250" - .234"
E25-017(C)	17/64"	.266" - .250"
E25-018(C)	9/32"	.281" - .266"
E25-019(C)	19/64"	.297" - .281"
E25-020(C)	5/16"	.312" - .297"
E25-021(C)	21/64"	.328" - .312"
E25-022(C)	11/32"	.344" - .328"
E25-023(C)	23/64"	.359" - .344"
E25-024(C)	3/8"	.375" - .359"
E25-025(C)	25/64"	.391" - .375"
E25-026(C)	13/32"	.406" - .391"
E25-027(C)	27/64"	.422" - .406"
E25-028(C)	7/16"	.437" - .422"
E25-029(C)	29/64"	.453" - .437"
E25-030(C)	15/32"	.469" - .453"
E25-031(C)	31/64"	.484" - .469"
E25-032(C)	1/2"	.500" - .484"
E25-033(C)	33/64"	.516" - .500"
E25-034(C)	17/32"	.531" - .516"
E25-035(C)	35/64"	.547" - .531"
E25-036(C)	9/16"	.563" - .547"
E25-037(C)	37/64"	.578" - .563"
E25-038(C)	19/32"	.594" - .578"
E25-039(C)	39/64"	.609" - .594"
E25-040(C)	5/8"	.625" - .609"

Size range: 6.0mm-16.0mm (0.236"-0.629")

METRIC-COOLANT-THRU		
Part Number	Size	Collapse Range
E25-236(C)	6.0mm	6.0mm - 5.5mm
E25-255(C)	6.5mm	6.5mm - 6.0mm
E25-275(C)	7.0mm	7.0mm - 6.5mm
E25-295(C)	7.5mm	7.5mm - 7.0mm
E25-314(C)	8.0mm	8.0mm - 7.5mm
E25-334(C)	8.5mm	8.5mm - 8.0mm
E25-354(C)	9.0mm	9.0mm - 8.5mm
E25-374(C)	9.5mm	9.5mm - 9.0mm
E25-393(C)	10.0mm	10.0mm - 9.5mm
E25-413(C)	10.5mm	10.5mm - 10.0mm
E25-433(C)	11.0mm	11.0mm - 10.5mm
E25-452(C)	11.5mm	11.5mm - 11.0mm
E25-472(C)	12.0mm	12.0mm - 11.5mm
E25-492(C)	12.5mm	12.5mm - 12.0mm
E25-511(C)	13.0mm	13.0mm - 12.5mm
E25-531(C)	13.5mm	13.5mm - 13.0mm
E25-551(C)	14.0mm	14.0mm - 13.5mm
E25-570(C)	14.5mm	14.5mm - 14.0mm
E25-590(C)	15.0mm	15.0mm - 14.5mm
E25-610(C)	15.5mm	15.5mm - 15.0mm
E25-629(C)	16.0mm	16.0mm - 15.5mm

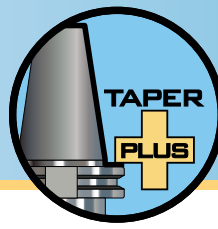

ER32 Collets

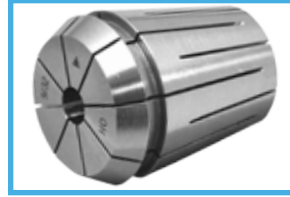
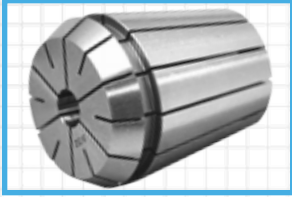

Our patented Coolant Collets are designed for use with cylindrical shank tools (no flats). Cutting tool should be inserted the full length of the collet. If these conditions are not met, coolant leakage may result. Seals up to maximum coolant pressure of 1000PSI.

Size Range: 1/8"-25/32"

INCH		
Part Number	Size	Collapse Range
E32-008	1/8"	.125" - .109"
E32-010	5/32"	.156" - .125"
E32-012	3/16"	.187" - .156"
E32-014	7/32"	.219" - .187"
E32-016	1/4"	.250" - .219"
-	17/64"	-
E32-018	9/32"	.281" - .250"
-	19/64"	-
E32-020	5/16"	.312" - .281"
-	21/64"	-
E32-022	11/32"	.344" - .312"
-	23/64"	-
E32-024	3/8"	.375" - .344"
-	25/64"	-
E32-026	13/32"	.406" - .375"
-	27/64"	-
E32-028	7/16"	.438" - .406"
-	29/64"	-
E32-030	15/32"	.469" - .437"
-	31/64"	-
E32-032	1/2"	.500" - .469"
-	33/64"	-
E32-034	17/32"	.531" - .500"
-	35/64"	-
E32-036	9/16"	.563" - .531"
-	37/64"	-
E32-038	19/32"	.594" - .563"
-	39/64"	-
E32-040	5/8"	.625" - .594"
-	41/64"	-
E32-042	21/32"	.656" - .625"
-	43/64"	-
E32-044	11/16"	.688" - .656"
-	45/64"	-
E32-046	23/32"	.719" - .688"
-	47/64"	-
E32-048	3/4"	.750" - .719"
-	49/64"	-
E32-050	25/32"	.781" - .750"

**Size range: 2.0mm - 20.0mm
(0.078"-0.787")**

METRIC		
Part Number	Size	Collapse Range
E32-118	3.0mm	3.0mm-2.0mm
E32-137	3.5mm	3.5mm-2.5mm
E32-157	4.0mm	4.0mm-3.0mm
E32-196	5.0mm	5.0mm-4.0mm
E32-236	6.0mm	6.0mm-5.0mm
E32-275	7.0mm	7.0mm-6.0mm
E32-314	8.0mm	8.0mm-7.0mm
E32-354	9.0mm	9.0mm-8.0mm
E32-393	10.0mm	10.0mm-9.0mm
E32-433	11.0mm	11.0mm-10.0mm
E32-452	11.5mm	11.5mm-10.5mm
E32-472	12.0mm	12.0mm-11.0mm
E32-511	13.0mm	13.0mm-12.0mm
E32-551	14.0mm	14.0mm-13.0mm
E32-590	15.0mm	15.0mm-14.0mm
E32-629	16.0mm	16.0mm-15.0mm
E32-669	17.0mm	17.0mm-16.0mm
E32-708	18.0mm	18.0mm-17.0mm
E32-748	19.0mm	19.0mm-18.0mm
E32-767	19.5mm	19.5mm-18.5mm
E32-787	20.0mm	20.0mm-19.0mm

Size Range: 1/4"-25/32"

INCH-COOLANT-THRU		
Part Number	Size	Collapse Range
E32-016(C)	1/4"	.250" - .234"
E32-017(C)	17/64"	.266" - .250"
E32-018(C)	9/32"	.281" - .266"
E32-019(C)	19/64"	.297" - .281"
E32-020(C)	5/16"	.312" - .297"
E32-021(C)	21/64"	.328" - .312"
E32-022(C)	11/32"	.344" - .328"
E32-023(C)	23/64"	.359" - .344"
E32-024(C)	3/8"	.375" - .359"
E32-025(C)	25/64"	.391" - .375"
E32-026(C)	13/32"	.406" - .391"
E32-027(C)	27/64"	.422" - .406"
E32-028(C)	7/16"	.437" - .422"
E32-029(C)	29/64"	.453" - .437"
E32-030(C)	15/32"	.469" - .453"
E32-031(C)	31/64"	.484" - .469"
E32-032(C)	1/2"	.500" - .484"
E32-033(C)	33/64"	.516" - .500"
E32-034(C)	17/32"	.531" - .516"
E32-035(C)	35/64"	.547" - .531"
E32-036(C)	9/16"	.563" - .547"
E32-037(C)	37/64"	.578" - .563"
E32-038(C)	19/32"	.594" - .578"
E32-039(C)	39/64"	.609" - .594"
E32-040(C)	5/8"	.625" - .609"
E32-041(C)	41/64"	.641" - .625"
E32-042(C)	21/32"	.656" - .641"
E32-043(C)	43/64"	.672" - .656"
E32-044(C)	11/16"	.688" - .672"
E32-045(C)	45/64"	.703" - .688"
E32-046(C)	23/32"	.719" - .703"
E32-047(C)	47/64"	.734" - .719"
E32-048(C)	3/4"	.750" - .734"
E32-049(C)	49/64"	.766" - .750"
E32-050(C)	25/32"	.781" - .766"

**Size range: 10.0mm-20.0mm
(0.393"-0.787")**

METRIC-COOLANT-THRU		
Part Number	Size	Collapse Range
E32-393(C)	10.0mm	10.0mm - 9.5mm
E32-413(C)	10.5mm	10.5mm - 10.0mm
E32-433(C)	11.0mm	11.0mm - 10.5mm
E32-452(C)	11.5mm	11.5mm - 11.0mm
E32-472(C)	12.0mm	12.0mm - 11.5mm
E32-492(C)	12.5mm	12.5mm - 12.4mm
E32-511(C)	13.0mm	13.0mm - 12.9mm
E32-531(C)	13.5mm	13.5mm - 13.0mm
E32-551(C)	14.0mm	14.0mm - 13.5mm
E32-570(C)	14.5mm	14.5mm - 14.4mm
E32-590(C)	15.0mm	15.0mm - 14.9mm
E32-610(C)	15.5mm	15.5mm - 15.4mm
E32-629(C)	16.0mm	16.0mm - 15.5mm
E32-649(C)	16.5mm	16.5mm - 16.0mm
E32-669(C)	17.0mm	17.0mm - 16.5mm
E32-688(C)	17.5mm	17.5mm - 17.0mm
E32-708(C)	18.0mm	18.0mm - 17.5mm
E32-728(C)	18.5mm	18.5mm - 18.0mm
E32-748(C)	19.0mm	19.0mm - 18.5mm
E32-767(C)	19.5mm	19.5mm - 19.0mm
E32-787(C)	20.0mm	20.0mm - 19.5mm

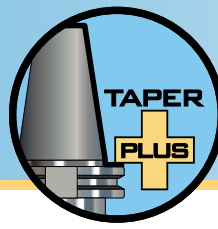

ER40 Collets

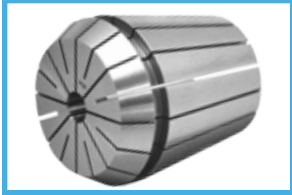

Our patented Coolant Collets are designed for use with cylindrical shank tools (no flats). Cutting tool should be inserted the full length of the collet. If these conditions are not met, coolant leakage may result. Seals up to maximum coolant pressure of 1000PSI.

Size Range: 5/32"-1"

INCH		
Part Number	Size	Collapse Range
E40-010	5/32"	.156" - .125"
E40-012	3/16"	.187" - .156"
E40-014	7/32"	.219" - .187"
E40-016	1/4"	.250" - .219"
E40-018	9/32"	.281" - .250"
E40-020	5/16"	.312" - .281"
E40-022	11/32"	.344" - .312"
E40-024	3/8"	.375" - .344"
E40-026	13/32"	.406" - .375"
E40-028	7/16"	.437" - .406"
E40-030	15/32"	.469" - .437"
E40-032	1/2"	.500" - .469"
E40-034	17/32"	.531" - .500"
E40-036	9/16"	.563" - .531"
E40-038	19/32"	.594" - .563"
E40-040	5/8"	.625" - .594"
E40-042	21/32"	.656" - .625"
E40-044	11/16"	.688" - .656"
E40-046	23/32"	.719" - .688"
E40-048	3/4"	.750" - .719"
E40-050	25/32"	.781" - .750"
E40-052	13/16"	.813" - .781"
E40-054	27/32"	.844" - .813"
E40-056	7/8"	.875" - .844"
E40-058	29/32"	.906" - .875"
E40-060	15/16"	.938" - .906"
E40-062	31/32"	.969" - .938"
E40-064	1"	1" - .969"

**Size range: 3.0mm - 26.0mm
(0.118"-1.023")**

METRIC		
Part Number	Size	Collapse Range
E40-157	4.0mm	4.0-3.0mm
E40-196	5.0mm	5.0-4.0mm
E40-236	6.0mm	6.0-5.0mm
E40-275	7.0mm	7.0-6.0mm
E40-314	8.0mm	8.0-7.0mm
E40-354	9.0mm	9.0-8.0 mm
E40-393	10.0mm	10.0-9.0mm
E40-433	11.0mm	11.0-10.0mm
E40-452	11.5mm	11.5-10.5mm
E40-472	12.0mm	12.0-11.0mm
E40-511	13.0mm	13.0-12.0mm
E40-551	14.0mm	14.0-13.0mm
E40-590	15.0mm	15.0-14.0mm
E40-629	16.0mm	16.0-15.0mm
E40-669	17.0mm	17.0-16.0mm
E40-708	18.0mm	18.0-17.0mm
E40-748	19.0mm	19.0-18.0mm
E40-767	19.5mm	19.5-18.5mm
E40-787	20.0mm	20.0-19.0mm
E40-826	21.0mm	21.0-20.0mm
E40-866	22.0mm	22.0-21.0mm
E40-905	23.0mm	23.0-22.0mm
E40-944	24.0mm	24.0-23.0mm
E40-984	25.0mm	25.0-24.0mm
E40-1023	26.0mm	26.0-25.0mm

Size Range: 5/16"-5/8"

INCH-COOLANT-THRU		
Part Number	Size	Collapse Range
E40-020(C)	5/16"	.312" - .297"
E40-024(C)	3/8"	.375" - .359"
E40-028(C)	7/16"	.437" - .422"
E40-032(C)	1/2"	.500" - .484"
E40-036(C)	9/16"	.563" - .547"
E40-040(C)	5/8"	.625" - .609"

**Size range: 10.0mm-26.0mm
(0.393"-1.023")**

METRIC-COOLANT-THRU		
Part Number	Size	Collapse Range
E40-393(C)	10.0mm	10.0mm - 9.5mm
E40-413(C)	10.5mm	10.5mm - 10.0mm
E40-433(C)	11.0mm	11.0mm - 10.5mm
E40-452(C)	11.5mm	11.5mm - 11.0mm
E40-472(C)	12.0mm	12.0mm - 11.5mm
E40-492(C)	12.5mm	12.5mm - 12.0mm
E40-511(C)	13.0mm	13.0mm - 12.5mm
E40-531(C)	13.5mm	13.5mm - 13.0mm
E40-551(C)	14.0mm	14.0mm - 13.5mm
E40-570(C)	14.5mm	14.5mm - 14.0mm
E40-590(C)	15.0mm	15.0mm - 14.5mm
E40-610(C)	15.5mm	15.5mm - 15.0mm
E40-629(C)	16.0mm	16.0mm - 15.5mm
E40-649(C)	16.5mm	16.5mm - 16.0mm
E40-669(C)	17.0mm	17.0mm - 16.5mm
E40-688(C)	17.5mm	17.5mm - 17.0mm
E40-708(C)	18.0mm	18.0mm - 17.5mm
E40-728(C)	18.5mm	18.5mm - 18.0mm
E40-748(C)	19.0mm	19.0mm - 18.5mm
E40-767(C)	19.5mm	19.5mm - 19.0mm
E40-787(C)	20.0mm	20.0mm - 19.5mm
E40-807(C)	20.5mm	20.5mm - 20.0mm
E40-826(C)	21.0mm	21.0mm - 20.5mm
E40-846(C)	21.5mm	21.5mm - 21.0mm
E40-866(C)	22.0mm	22.0mm - 21.5mm
E40-885(C)	22.5mm	22.5mm - 22.0mm
E40-905(C)	23.0mm	23.0mm - 22.5mm
E40-925(C)	23.5mm	23.5mm - 23.0mm
E40-944(C)	24.0mm	24.0mm - 23.5mm
E40-964(C)	24.5mm	24.5mm - 24.0mm
E40-984(C)	25.0mm	25.0mm - 24.5mm
E40-1003(C)	25.5mm	25.5mm - 25.0mm
E40-1023(C)	26.0mm	26.0mm - 25.0mm

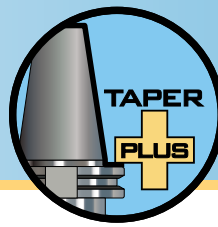

MMC Collet Chucks

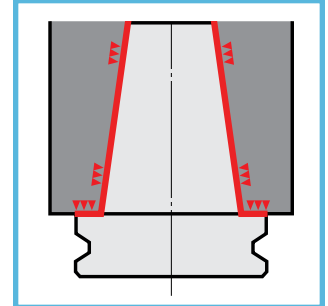
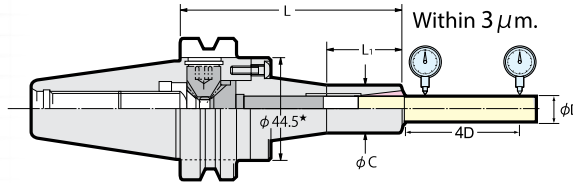
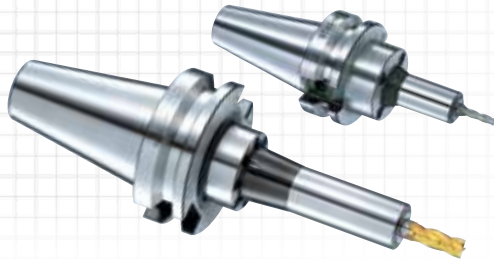

Wrench is included

Part Number	Collet Series	Clamping Range	L	L1	C
CAT 40					
NCAT40-MMC8C-90	VMK8	0.125 - 0.375"	3.543"	1.299"	0.787"
NCAT40-MMC12C-90	VMK12	0.1875 - 0.500"	3.543"	1.378"	1.181"
BT 30					
NBT30-MMC8C-105	VMK8	0.125 - 0.375"	4.134"	1.417"	0.787"
NBT30-MMC12C-105	VMK12	0.1875 - 0.500"	4.134"	1.378"	1.181"
BT 40					
NBT40-MMC8C-90	VMK8	0.125 - 0.375"	3.543"	1.417"	0.787"
NBT40-MMC12C-90	VMK12	0.1875 - 0.500"	3.543"	1.378"	1.181"

MPK4 Collet-Inch and Metric

Size	Collet Number
1/16"	MPK4-1/16
3/32"	MPK4-3/32
1.0mm	MPK4-1
1.5mm	MPK4-1.5
2.0mm	MPK4-2
2.5mm	MPK4-2.5
3.0mm	MPK4-3
3.5mm	MPK4-3.5
4.0mm	MPK4-4

VMK8 Collet-Inch and Metric

Size	Collet Number	Slotted Collet
1/8"	VMK8-1/8	VMK8-1/8J
3/16"	VMK8-3/16	VMK8-3/16J
1/4"	VMK8-1/4	VMK8-1/4J
5/16"	VMK8-5/16	VMK8-5/16J
3/8"	VMK8-3/8	VMK8-3/8J
2.0mm	VMK8-2	VMK8-2J
3.0mm	VMK8-3	VMK8-3J
4.0mm	VMK8-4	VMK8-4J
5.0mm	VMK8-5	VMK8-5J
6.0mm	VMK8-6	VMK8-6J
8.0mm	VMK8-8	VMK8-8J
10.0mm	VMK8-10	VMK8-10J

VMK12 Collet-Inch and Metric

Size	Collet Number	Slotted Collet
3/16"	VMK12-3/16	VMK12-3/16J
1/4"	VMK12-1/4	VMK12-1/4J
5/16"	VMK12-5/16	VMK12-5/16J
3/8"	VMK12-3/8	VMK12-3/8J
7/16"	VMK12-7/16	VMK12-7/16J
1/2"	VMK12-1/2	VMK12-1/2J
4.0mm	VMK12-4	VMK12-4J
5.0mm	VMK12-5	VMK12-5J
6.0mm	VMK12-6	VMK12-6J
8.0mm	VMK12-8	VMK12-8J
10.0mm	VMK12-10	VMK12-10J
12.0mm	VMK12-12	VMK12-12J



MPK Collet



VMK Collet

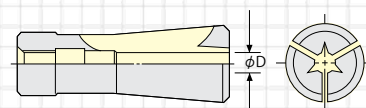

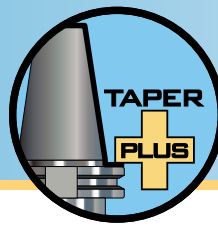

VC6 Collet Chucks

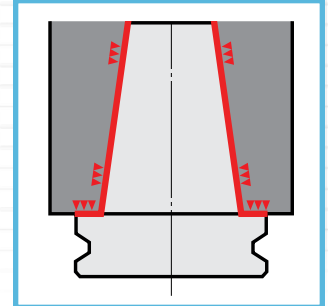
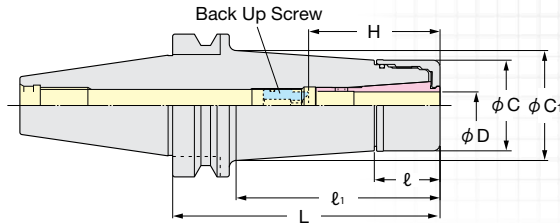

Part Number	Collet Series	Wrench	L	ℓ	ℓ_1	C	C1	H	D	Back Up Screw
CAT 40										
NCAT40-VC6-60U	VC6	GH10	2.362"	0.906"	0.906"	1.083"	1.083"	1.378 - 1.772"	0.078 - 0.236"	VCG6-8A
NCAT40-VC6-90U	VC6	GH10	3.543"	0.906"	2.047"	1.083"	1.244"	1.378 - 1.772"	0.078 - 0.236"	VCG6-8A
NCAT40-VC6-120U	VC6	GH10	4.724"	0.906"	3.228"	1.083"	1.409"	1.378 - 1.772"	0.078 - 0.236"	VCG6-8A
CAT 50										
NCAT50-VC6-105U	VC6	GH10	4.134"	0.906"	2.559"	1.083"	1.315"	1.378 - 1.772"	0.078 - 0.236"	VCG6-8A
NCAT50-VC6-135U	VC6	GH10	5.315"	0.906"	3.740"	1.083"	1.480"	1.378 - 1.772"	0.078 - 0.236"	VCG6-8A
NCAT50-VC6-165U	VC6	GH10	6.496"	0.906"	4.921"	1.083"	1.646"	1.378 - 1.772"	0.078 - 0.236"	VCG6-8A
BT 30										
NBT30-VC6-45	VC6	GH10	1.772"	0.906"	0.906"	1.083"	1.083"	1.378 - 1.772"	0.078 - 0.236"	VCG6-8A
NBT30-VC6-60	VC6	GH10	2.362"	0.906"	1.378"	1.083"	1.248"	1.378 - 1.772"	0.078 - 0.236"	VCG6-8A
NBT30-VC6-90	VC6	GH10	3.543"	0.906"	2.559"	1.083"	1.315"	1.378 - 1.772"	0.078 - 0.236"	VCG6-8A
BT 40										
NBT40-VC6-60	VC6	GH10	2.362"	0.906"	1.181"	1.083"	1.181"	1.378 - 1.772"	0.078 - 0.236"	VCG6-8A
NBT40-VC6-90	VC6	GH10	3.543"	0.906"	2.362"	1.083"	1.287"	1.378 - 1.772"	0.078 - 0.236"	VCG6-8A
NBT40-VC6-120	VC6	GH10	4.724"	0.906"	3.543"	1.083"	1.453"	1.378 - 1.772"	0.078 - 0.236"	VCG6-8A
NBT40-VC6-150	VC6	GH10	5.906"	0.906"	4.488"	1.083"	1.75"	1.378 - 1.772"	0.078 - 0.236"	VCG6-8A

VC Collets-Inch

Part Number	Collet Size
VCK6-1/8	1/8"
VCK6-3/16	3/16"
VCK6-1/4	1/4"

VC Collets-Metric

Part Number	Collet Size
VCK6-2	2.0mm
VCK6-3	3.0mm
VCK6-4	4.0mm
VCK6-5	5.0mm
VCK6-6	6.0mm

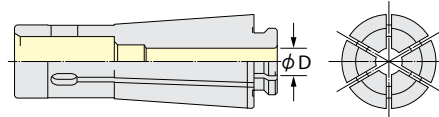

VC Collet

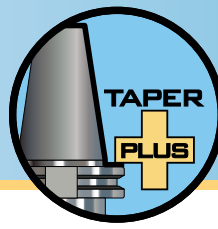

VC13 Collet Chucks

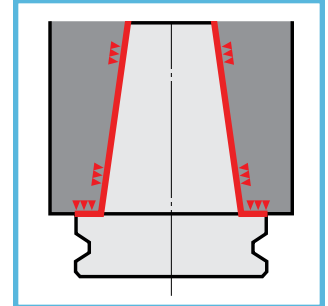
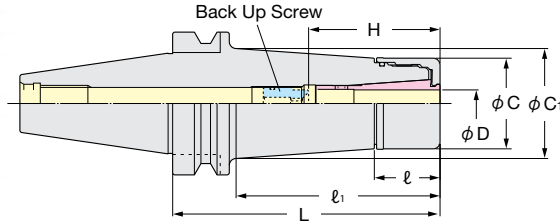
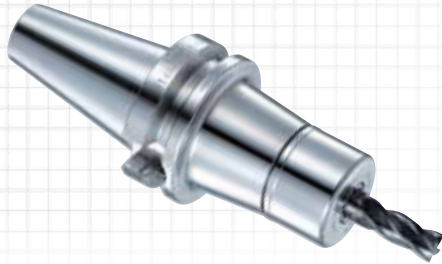

Part Number	Collet Series	Wrench	L	ℓ	ℓ1	C	C1	H	D	Back Up Screw
-------------	---------------	--------	---	---	----	---	----	---	---	---------------

CAT 40

NCAT40-VC13-60U	VC13	GH16	2.362"	1.142"	1.142"	1.575"	1.575"	1.969 - 2.362"	0.125 - 0.500"	VCG13-15A
NCAT40-VC13-90U	VC13	GH16	3.543"	1.142"	2.756"	1.575"	1.75"	1.969 - 2.362"	0.125 - 0.500"	VCG13-15A
NCAT40-VC13-120U	VC13	GH16	4.724"	1.142"	3.937"	1.575"	1.75"	1.969 - 2.362"	0.125 - 0.500"	VCG13-15A

CAT 50

NCAT50-VC13-105U	VC13	GH16	4.134"	1.142"	2.559"	1.575"	1.773"	1.969 - 2.362"	0.125 - 0.500"	VCG13-15A
NCAT50-VC13-135U	VC13	GH16	5.315"	1.142"	3.740"	1.575"	1.938"	1.969 - 2.362"	0.125 - 0.500"	VCG13-15A
NCAT50-VC13-165U	VC13	GH16	6.496"	1.142"	4.921"	1.575"	2.104"	1.969 - 2.362"	0.125 - 0.500"	VCG13-15A

BT 30

NBT30-VC13-60	VC13	GH16	2.362"	1.142"	1.457"	1.575"	1.618"	1.969 - 2.362"	0.125 - 0.500"	VCG13-15A
NBT30-VC13-90	VC13	GH16	3.543"	1.142"	2.638"	1.575"	1.626"	1.969 - 2.362"	0.125 - 0.500"	VCG13-15A
NBT30-VC13-120	VC13	GH16	4.724"	1.142"	3.819"	1.575"	1.669"	1.969 - 2.362"	0.125 - 0.500"	VCG13-15A

BT 40

NBT40-VC13-60	VC13	GH16	2.362"	1.142"	1.220"	1.575"	1.587"	1.969 - 2.362"	0.125 - 0.500"	VCG13-15A
NBT40-VC13-90	VC13	GH16	3.543"	1.142"	2.362"	1.575"	1.744"	1.969 - 2.362"	0.125 - 0.500"	VCG13-15A
NBT40-VC13-120	VC13	GH16	4.724"	1.142"	3.543"	1.575"	1.909"	1.969 - 2.362"	0.125 - 0.500"	VCG13-15A
NBT40-VC13-150	VC13	GH16	5.906"	1.142"	2.362"	1.575"	1.75"	1.969 - 2.362"	0.125 - 0.500"	VCG13-15A

VC Collets-Inch

Part Number	Collet Size
VCK13-1/8	1/8"
VCK13-3/16	3/16"
VCK13-1/4	1/4"
VCK13-5/16	5/16"
VCK13-3/8	3/8"
VCK13-7/16	7/16"
VCK13-1/2	1/2"

VC Collets-Metric

Part Number	Collet Size
VCK13-3	3.0mm
VCK13-4	4.0mm
VCK13-5	5.0mm
VCK13-6	6.0mm
VCK13-7	7.0mm
VCK13-8	8.0mm
VCK13-9	9.0mm
VCK13-10	10.0mm
VCK13-11	11.0mm
VCK13-12	12.0mm

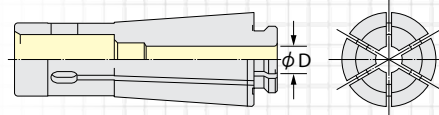

VC Collet

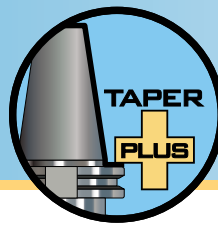

SK6 Collet Chucks

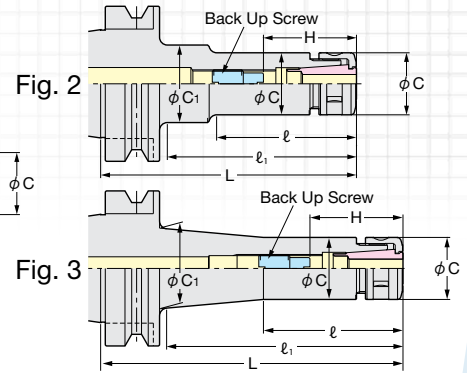
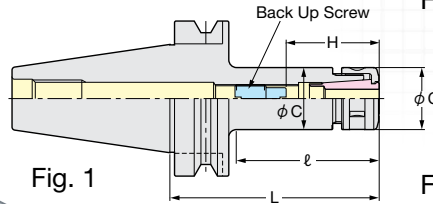
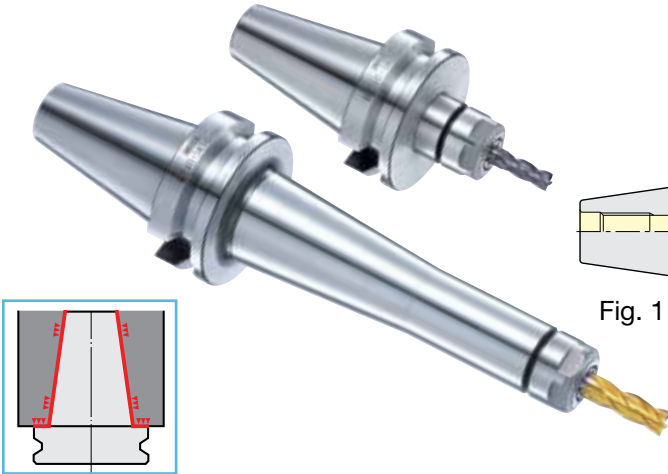

Part Number	Collet Series	Wrench	Clamping Range	L	ℓ	ℓ1	C	C1	H	Back Up Screw	Figure
-------------	---------------	--------	----------------	---	---	----	---	----	---	---------------	--------

CAT 40

NCAT40-SK6C-90U	SK6	SKL-6W	0.027 - 0.236"	3.543"	2.165"	2.793"	0.768"	1.75"	0.826 - 1.378"	SKG6-6HG	2
NCAT40-SK6C-120U	SK6	SKL-6W	0.027 - 0.236"	4.724"	2.441"	3.346"	0.768"	1.260"	0.826 - 1.378"	SKG6-6HG	2
NCAT40-SK6C-150U	SK6	SKL-6W	0.027 - 0.236"	5.906"	2.362"	4.528"	0.768"	0.984"	0.826 - 1.378"	SKG6-6HG	3

CAT 50

NCAT50-SK6C-105U	SK6	SKL-6W	0.027 - 0.236"	4.134"	2.756"	3.384"	0.768"	2.75"	0.826 - 1.378"	SKG6-6HG	2
NCAT50-SK6C-165U	SK6	SKL-6W	0.027 - 0.236"	6.496"	2.441"	5.118"	0.768"	1.260"	0.826 - 1.378"	SKG6-6HG	2
NCAT50-SK6C-195U	SK6	SKL-6W	0.027 - 0.236"	7.677"	2.362"	6.299"	0.768"	1.181"	0.826 - 1.378"	SKG6-6HG	3

BT 30

NBT30-SK6C-60	SK6	SKL-6W	0.027 - 0.236"	2.362"	1.299"	n/a	0.768"	0.768"	0.826 - 1.378"	SKG6-6HG	1
NBT30-SK6C-90	SK6	SKL-6W	0.027 - 0.236"	3.543"	2.205"	2.559"	0.768"	1.260"	0.826 - 1.378"	SKG6-6HG	2
NBT30-SK6C-120	SK6	SKL-6W	0.027 - 0.236"	4.724"	2.441"	3.740"	0.768"	1.260"	0.826 - 1.378"	SKG6-6HG	2

BT 40

NBT40-SK6C-60	SK6	SKL-6W	0.027 - 0.236"	2.362"	1.181"	n/a	0.768"	0.768"	0.826 - 1.378"	SKG6-6HG	1
NBT40-SK6C-90	SK6	SKL-6W	0.027 - 0.236"	3.543"	2.008"	2.362"	0.768"	1.260"	0.826 - 1.378"	SKG6-6HG	2
NBT40-SK6C-120	SK6	SKL-6W	0.027 - 0.236"	4.724"	2.362"	3.543"	0.768"	1.260"	0.826 - 1.378"	SKG6-6HG	2
NBT40-SK6C-150	SK6	SKL-6W	0.027 - 0.236"	5.906"	2.362"	4.724"	0.768"	0.984"	0.826 - 1.378"	SKG6-6HG	3

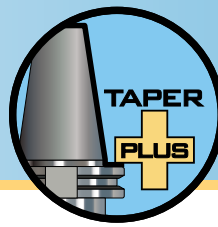

SK10 Collet Chucks

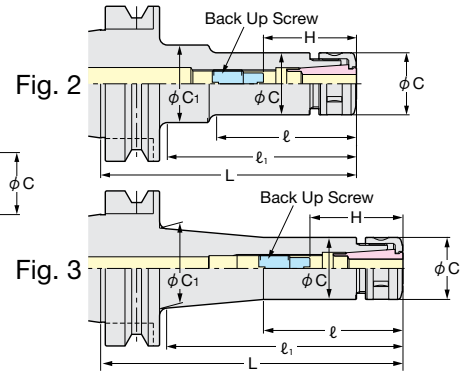
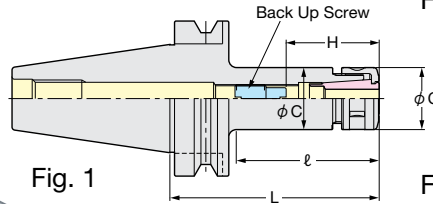
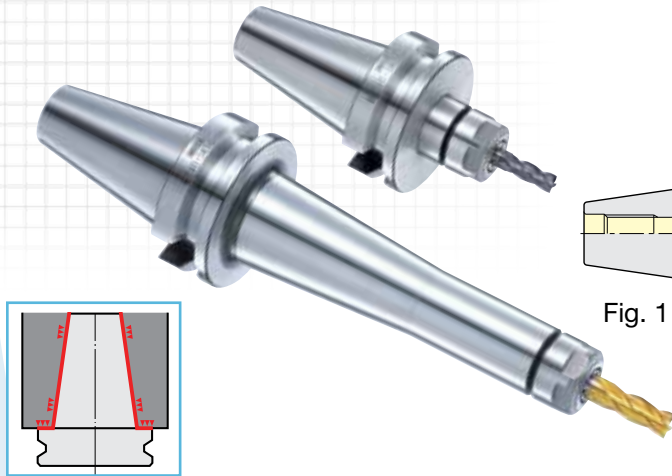

Part Number	Collet Series	Wrench	Clamping Range	L	ℓ	ℓ1	C	C1	H	Back Up Screw 4mm+ (.157"+)	Back Up Screw 6mm+ (.236"+)	Figure
-------------	---------------	--------	----------------	---	---	----	---	----	---	--------------------------------	--------------------------------	--------

CAT 40

NCAT40-SK10C-90U	SK10	SKL-10	0.068 - 0.393"	3.543"	1.969"	2.793"	1.083"	1.75"	1.181 - 1.969"	SKG10-10HGA	SKG10-10HG	2
NCAT40-SK10C-120U	SK10	SKL-10	0.068 - 0.393"	4.724"	2.756"	3.346"	1.083"	1.260"	1.181 - 1.969"	SKG10-10HGA	SKG10-10HG	2
NCAT40-SK10C-150U	SK10	SKL-10	0.068 - 0.393"	5.906"	2.874"	4.528"	1.083"	1.343"	1.181 - 1.969"	SKG10-10HGA	SKG10-10HG	3
NCAT40-SK10C-180U	SK10	SKL-10	0.068 - 0.393"	7.087"	2.874"	5.827"	1.083"	1.343"	1.181 - 1.969"	SKG10-10HGA	SKG10-10HG	3

CAT 50

NCAT50-SK10C-105U	SK10	SKL-10	0.068 - 0.393"	4.138"	2.362"	3.384"	1.083"	2.75"	1.181 - 1.969"	SKG10-10HGA	SKG10-10HG	2
NCAT50-SK10C-165U	SK10	SKL-10	0.068 - 0.393"	6.496"	2.953"	5.118"	1.083"	1.260"	1.181 - 1.969"	SKG10-10HGA	SKG10-10HG	2
NCAT50-SK10C-195U	SK10	SKL-10	0.068 - 0.393"	7.677"	2.953"	6.299"	1.083"	1.417"	1.181 - 1.969"	SKG10-10HGA	SKG10-10HG	3
NCAT50-SK10C-225U	SK10	SKL-10	0.068 - 0.393"	8.858"	2.953"	7.677"	1.083"	1.575"	1.181 - 1.969"	SKG10-10HGA	SKG10-10HG	3

BT 30

NBT30-SK10C-45	SK10	SKL-10	0.068 - 0.393"	1.772"	0.866"	n/a	1.083"	1.083"	1.181 - 1.969"	SKG10-10HGA	SKG10-10HG	1
NBT30-SK10C-60	SK10	SKL-10	0.068 - 0.393"	2.362"	1.378"	n/a	1.083"	1.083"	1.181 - 1.969"	SKG10-10HGA	SKG10-10HG	1
NBT30-SK10C-75	SK10	SKL-10	0.068 - 0.393"	2.953"	1.969"	n/a	1.083"	1.083"	1.181 - 1.969"	SKG10-10HGA	SKG10-10HG	1
NBT30-SK10C-90	SK10	SKL-10	0.068 - 0.393"	3.543"	2.559"	n/a	1.083"	1.083"	1.181 - 1.969"	SKG10-10HGA	SKG10-10HG	1
NBT30-SK10C-120	SK10	SKL-10	0.068 - 0.393"	4.724"	3.740"	n/a	1.083"	1.083"	1.181 - 1.969"	SKG10-10HGA	SKG10-10HG	1

BT 40

NBT40-SK10C-60	SK10	SKL-10	0.068 - 0.393"	2.362"	1.260"	n/a	1.083"	1.083"	1.181 - 1.969"	SKG10-10HGA	SKG10-10HG	1
NBT40-SK10C-75	SK10	SKL-10	0.068 - 0.393"	2.953"	1.575"	n/a	1.083"	1.083"	1.181 - 1.969"	SKG10-10HGA	SKG10-10HG	1
NBT40-SK10C-90	SK10	SKL-10	0.068 - 0.393"	3.543"	1.890"	2.362"	1.083"	1.575"	1.181 - 1.969"	SKG10-10HGA	SKG10-10HG	2
NBT40-SK10C-120	SK10	SKL-10	0.068 - 0.393"	4.724"	2.874"	3.543"	1.083"	1.575"	1.181 - 1.969"	SKG10-10HGA	SKG10-10HG	2
NBT40-SK10C-150	SK10	SKL-10	0.068 - 0.393"	5.906"	2.874"	4.646"	1.083"	1.358"	1.181 - 1.969"	SKG10-10HGA	SKG10-10HG	3
NBT40-SK10C-180	SK10	SKL-10	0.068 - 0.393"	7.087"	2.874"	5.827"	1.083"	1.535"	1.181 - 1.969"	SKG10-10HGA	SKG10-10HG	3
NBT40-SK10C-200	SK10	SKL-10	0.068 - 0.393"	7.874"	2.874"	6.614"	1.083"	1.535"	1.181 - 1.969"	SKG10-10HGA	SKG10-10HG	3
NBT40-SK10C-250	SK10	SKL-10	0.068 - 0.393"	9.843"	2.874"	8.583"	1.083"	1.535"	1.181 - 1.969"	SKG10-10HGA	SKG10-10HG	3

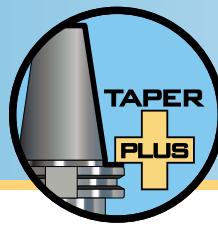

SK16 Collet Chucks

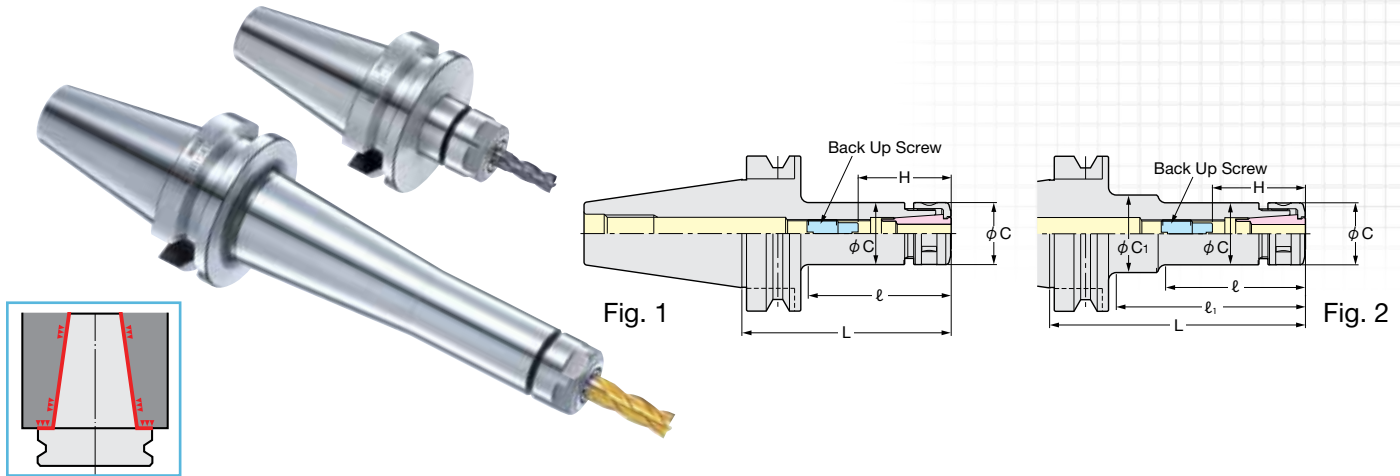

Part Number	Collet Series	Wrench	Clamping Range	L	ℓ	ℓ1	C	C1	H	Back Up Screw 5mm+ (.197"+)	Back Up Screw 10mm+ (.394"+)	Figure
-------------	---------------	--------	----------------	---	---	----	---	----	---	--------------------------------	---------------------------------	--------

CAT 40

NCAT40-SK16C-60U	SK16	9HC16	0.108 - 0.629"	2.362"	1.612"	n/a	1.575"	1.575"	1.968 - 2.559"	SKG16-10HGA	SKG16-10HG	1
NCAT40-SK16C-90U	SK16	9HC16	0.108 - 0.629"	3.543"	2.165"	2.793"	1.575"	1.75"	1.772 - 2.756"	SKG16-12HGA	SKG16-12HG	2
NCAT40-SK16C-120U	SK16	9HC16	0.108 - 0.629"	4.724"	3.547"	4.175"	1.575"	1.75"	1.772 - 2.756"	SKG16-12HGA	SKG16-12HG	2
NCAT40-SK16C-150U	SK16	9HC16	0.108 - 0.629"	5.906"	4.728"	5.356"	1.575"	1.75"	1.772 - 2.756"	SKG16-12HGA	SKG16-12HG	2
NCAT40-SK16C-180U	SK16	9HC16	0.108 - 0.629"	7.087"	5.081"	5.709"	1.575"	1.75"	1.654 - 2.244"	SKG16-12HGA	SKG16-12HG	2

CAT 50

NCAT50-SK16C-105U	SK16	9HC16	0.108 - 0.629"	4.138"	3.384"	2.756"	1.575"	2.75"	2.165 - 3.346"	SKG16-12HGA	SKG16-12HG	2
NCAT50-SK16C-165U	SK16	9HC16	0.108 - 0.629"	6.496"	5.118"	5.746"	1.575"	2.75"	2.165 - 3.346"	SKG16-12HGA	SKG16-12HG	2
NCAT50-SK16C-195U	SK16	9HC16	0.108 - 0.629"	7.677"	6.496"	6.927"	1.575"	2.75"	2.165 - 3.346"	SKG16-12HGA	SKG16-12HG	2

BT 30

NBT30-SK16C-60	SK16	9HC16	0.108 - 0.629"	2.362"	1.457"	n/a	1.575"	1.575"	1.850 - 2.047"	n/a	SKG16-12HGE	1
NBT30-SK16C-75	SK16	9HC16	0.108 - 0.629"	2.953"	2.047"	n/a	1.575"	1.575"	1.772 - 2.047"	SKG16-10HGA	SKG16-10HG	1
NBT30-SK16C-90	SK16	9HC16	0.108 - 0.629"	3.543"	2.638"	n/a	1.575"	1.575"	1.772 - 2.559"	SKG16-12HGA	SKG16-12HG	1
NBT30-SK16C-120	SK16	9HC16	0.108 - 0.629"	4.724"	3.819"	n/a	1.575"	1.575"	1.772 - 2.559"	SKG16-12HGA	SKG16-12HG	1

BT 40

NBT40-SK16C-60	SK16	9HC16	0.108 - 0.629"	2.362"	1.260"	n/a	1.575"	1.575"	1.969 - 2.559"	SKG16-10HGA	SKG16-10HG	1
NBT40-SK16C-75	SK16	9HC16	0.108 - 0.629"	2.953"	1.772"	n/a	1.575"	1.575"	1.575 - 2.638"	SKG16-12HGA	SKG16-12HG	1
NBT40-SK16C-90	SK16	9HC16	0.108 - 0.629"	3.543"	2.283"	n/a	1.575"	1.575"	1.575 - 2.756"	SKG16-12HGA	SKG16-12HG	1
NBT40-SK16C-120	SK16	9HC16	0.108 - 0.629"	4.724"	3.465"	n/a	1.575"	1.575"	1.575 - 2.756"	SKG16-12HGA	SKG16-12HG	1
NBT40-SK16C-150	SK16	9HC16	0.108 - 0.629"	5.906"	4.646"	n/a	1.575"	1.575"	1.575 - 2.756"	SKG16-12HGA	SKG16-12HG	1
NBT40-SK16C-180	SK16	9HC16	0.108 - 0.629"	7.087"	5.823"	n/a	1.575"	1.575"	1.575 - 2.756"	SKG16-12HGA	SKG16-12HG	1
NBT40-SK16C-200	SK16	9HC16	0.108 - 0.629"	7.874"	6.614"	n/a	1.575"	1.575"	1.575 - 2.756"	SKG16-12HGA	SKG16-12HG	1
NBT40-SK16C-250	SK16	9HC16	0.108 - 0.629"	9.843"	8.583"	n/a	1.575"	1.575"	1.575 - 2.756"	SKG16-12HGA	SKG16-12HG	1

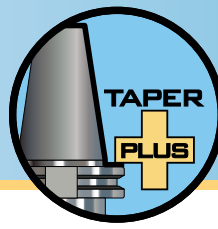

SK25 Collet Chucks

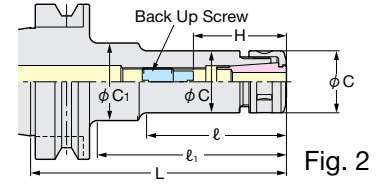
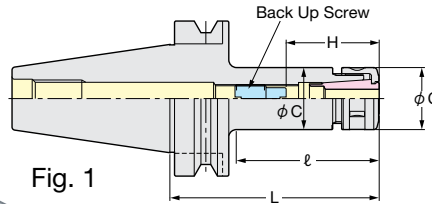
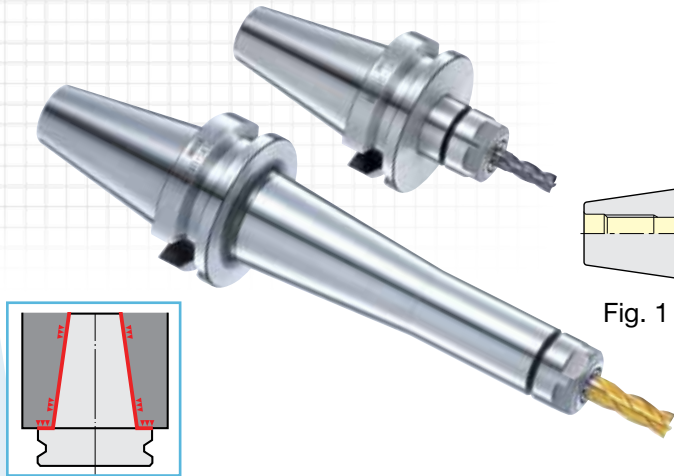

Part Number	Collet Series	Wrench	Clamping Range	L	ℓ	ℓ1	C	C1	H	Back Up Screw	Figure
CAT 40											
NCAT40-SK25C-90U	SK25	9HC22	0.295 - 1.000"	3.543"	2.793"	n/a	2.165"	2.165"	2.165 - 3.346"	SKG25-18HGD	1
NCAT40-SK25C-120U	SK25	9HC22	0.295 - 1.000"	4.724"	3.974"	n/a	2.165"	2.165"	2.165 - 3.346"	SKG25-24HG	1
CAT 50											
NCAT50-SK25C-105U	SK25	9HC22	0.295 - 1.000"	4.134"	2.559"	3.384"	2.165"	2.75"	2.165 - 3.346"	SKG25-24HG	2
NCAT50-SK25C-165U	SK25	9HC22	0.295 - 1.000"	6.496"	4.921"	5.746"	2.165"	2.75"	2.165 - 3.346"	SKG25-24HG	2
NCAT50-SK25C-195U	SK25	9HC22	0.295 - 1.000"	7.677"	6.102"	6.927"	2.165"	2.75"	2.165 - 3.346"	SKG25-24HG	2
BT 30											
NBT30-SK25-90	SK25	9HC22	0.295 - 1.000"	3.543"	2.638"	n/a	2.165"	2.165"	2.165 - 2.953"	SKG25-24HG	1
BT 40											
NBT40-SK25C-75	SK25	9HC22	0.295 - 1.000"	2.953"	1.850"	n/a	2.165"	2.165"	2.165 - 2.953"	SKG25-24HGE	1
NBT40-SK25C-90	SK25	9HC22	0.295 - 1.000"	3.543"	2.402"	n/a	2.165"	2.165"	2.165 - 2.953"	SKG25-18HGD	1
NBT40-SK25C-120	SK25	9HC22	0.295 - 1.000"	4.724"	3.583"	n/a	2.165"	2.165"	2.165 - 3.346"	SKG25-24HG	1

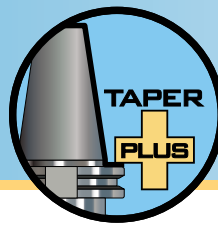

SK6-P Slim Chuck Coolant High Speed

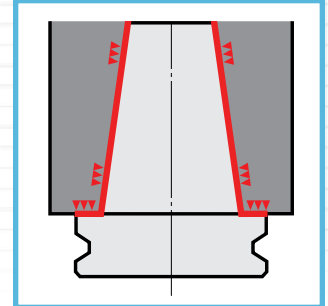
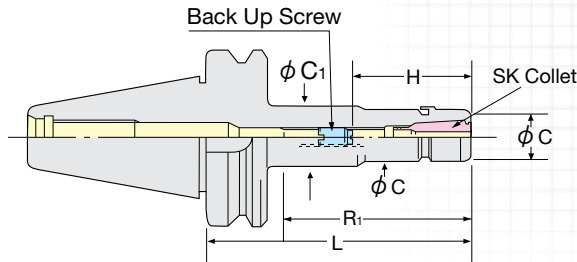

Part Number	Collet Series	Wrench	Clamping Range	L	R1	H	C	C1	Back Up Screw
-------------	---------------	--------	----------------	---	----	---	---	----	---------------

CAT 40

NCAT40-SK6C-90UP	SK6	GH6	0.027 - 0.236"	3.543"	2.165"	1.024-1.220"	0.768"	1.75"	SKG6-6HG
NCAT40-SK6C-120UP	SK6	GH6	0.027 - 0.236"	4.724"	2.441"	1.024-1.220"	0.768"	1.260"	SKG6-6HG
NCAT40-SK6C-150UP	SK6	GH6	0.027 - 0.236"	5.906"	2.362"	1.024-1.220"	0.768"	0.984"	SKG6-6HG

CAT 50

NCAT50-SK6C-105UP	SK6	GH6	0.027 - 0.236"	4.134"	2.362"	1.024-1.220"	0.768"	2.75"	SKG6-6HG
NCAT50-SK6C-165UP	SK6	GH6	0.027 - 0.236"	6.496"	2.441"	1.024-1.220"	0.768"	1.260"	SKG6-6HG

BT 30

NBT30-SK6C-60P	SK6	GH6	0.027 - 0.236"	2.362"	1.299"	1.024-1.220"	0.768"	0.768"	SKG6-6HG
NBT30-SK6C-90P	SK6	GH6	0.027 - 0.236"	3.543"	2.559"	1.024-1.220"	0.768"	1.260"	SKG6-6HG
NBT30-SK6C-120P	SK6	GH6	0.027 - 0.236"	4.724"	3.839"	1.024-1.220"	0.768"	1.260"	SKG6-6HG

BT 40

NBT40-SK6C-60P	SK6	GH6	0.027 - 0.236"	2.362"	1.181"	1.024-1.220"	0.768"	0.768"	SKG6-6HG
NBT40-SK6C-90P	SK6	GH6	0.027 - 0.236"	3.543"	2.362"	1.024-1.220"	0.768"	1.260"	SKG6-6HG
NBT40-SK6C-120P	SK6	GH6	0.027 - 0.236"	4.724"	3.543"	1.024-1.220"	0.768"	1.260"	SKG6-6HG
NBT40-SK6C-150P	SK6	GH6	0.027 - 0.236"	5.906"	5.236"	1.024-1.220"	0.768"	0.984"	SKG6-6HG

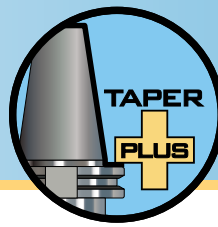

SK10-P Slim Chuck Coolant High Speed

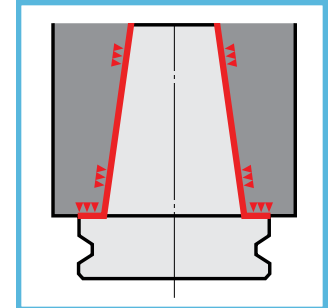
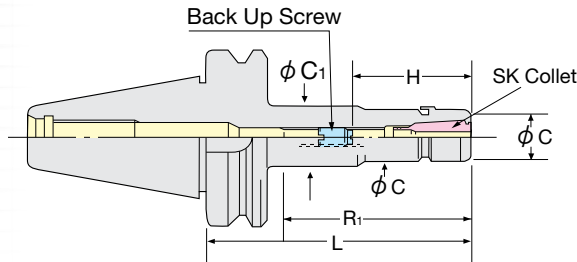

Part Number	Collet Series	Wrench	Clamping Range	L	R1	H	C	C1	Back Up Screw
-------------	---------------	--------	----------------	---	----	---	---	----	---------------

CAT 40

NCAT40-SK10C-90UP	SK10	GH10	0.068 - 0.393"	3.543"	1.969"	1.299-1.614"	1.083"	1.75"	SKG10-10HG
NCAT40-SK10C-120UP	SK10	GH10	0.068 - 0.393"	4.724"	2.756"	1.299-1.614"	1.083"	1.260"	SKG10-10HG
NCAT40-SK10C-150UP	SK10	GH10	0.068 - 0.393"	5.906"	2.874"	1.299-1.614"	1.083"	1.343"	SKG10-10HG

CAT 50

NCAT50-SK10C-105UP	SK10	GH10	0.068 - 0.393"	4.134"	2.756"	1.299-1.614"	1.083"	2.75"	SKG10-10HG
NCAT50-SK10C-165UP	SK10	GH10	0.068 - 0.393"	6.496"	2.953"	1.299-1.614"	1.083"	1.260"	SKG10-10HG

BT 30

NBT30-SK10C-45P	SK10	GH10	0.068 - 0.393"	1.772"	0.866"	1.299-1.614"	1.083"	1.083"	SKG10-10HG
NBT30-SK10C-60P	SK10	GH10	0.068 - 0.393"	2.362"	1.378"	1.299-1.614"	1.083"	1.083"	SKG10-10HG
NBT30-SK10C-75P	SK10	GH10	0.068 - 0.393"	2.953"	1.969"	1.299-1.614"	1.083"	1.083"	SKG10-10HG
NBT30-SK10C-90P	SK10	GH10	0.068 - 0.393"	3.543"	2.559"	1.299-1.614"	1.083"	1.083"	SKG10-10HG
NBT30-SK10C-120P	SK10	GH10	0.068 - 0.393"	4.724"	3.858"	1.299-1.614"	1.083"	1.083"	SKG10-10HG

BT 40

NBT40-SK10C-60P	SK10	GH10	0.068 - 0.393"	2.362"	1.260"	1.299-1.614"	1.083"	1.083"	SKG10-10HG
NBT40-SK10C-75P	SK10	GH10	0.068 - 0.393"	2.953"	1.772"	1.299-1.614"	1.083"	1.083"	SKG10-10HG
NBT40-SK10C-90P	SK10	GH10	0.068 - 0.393"	3.543"	2.362"	1.299-1.614"	1.083"	1.575"	SKG10-10HG
NBT40-SK10C-120P	SK10	GH10	0.068 - 0.393"	4.724"	3.543"	1.299-1.614"	1.083"	1.575"	SKG10-10HG
NBT40-SK10C-150P	SK10	GH10	0.068 - 0.393"	5.906"	4.646"	1.299-1.614"	1.083"	1.358"	SKG10-10HG

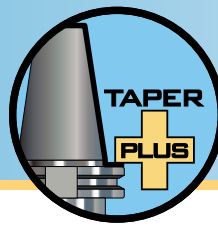

SK16-P & SK25-P Slim Chuck Coolant High Speed

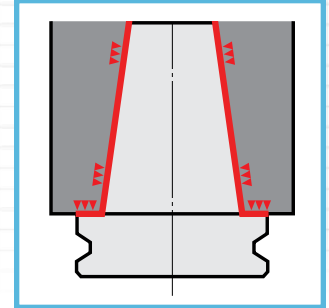
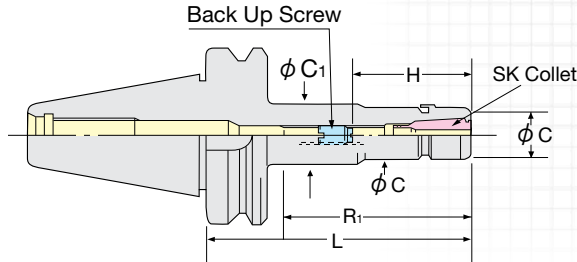

Part Number	Collet Series	Wrench	Clamping Range	L	R1	H	C	C1	Back Up Screw
-------------	---------------	--------	----------------	---	----	---	---	----	---------------

CAT 40

NCAT40-SK16C-60UP	SK16	GH16	0.108 - 0.629"	2.362"	1.612"	1.772-2.756"	1.575"	1.575"	n/a
NCAT40-SK16C-90UP	SK16	GH16	0.108 - 0.629"	3.543"	2.165"	1.772-2.756"	1.575"	1.75"	SKG-18L
NCAT40-SK16C-120UP	SK16	GH16	0.108 - 0.629"	4.724"	3.346"	1.772-2.756"	1.575"	1.75"	SKG-18L
NCAT40-SK16C-150UP	SK16	GH16	0.108 - 0.629"	5.906"	4.526"	1.772-2.756"	1.575"	1.75"	SKG-18L

CAT 50

NCAT50-SK16C-105UP	SK16	GH16	0.108 - 0.629"	4.134"	2.756"	1.772-2.756"	1.575"	2.75"	SKG-18L
NCAT50-SK16C-165UP	SK16	GH16	0.108 - 0.629"	6.496"	3.740"	1.772-2.756"	1.575"	2.75"	SKG-18L

BT 30

NBT30-SK16C-60P	SK16	GH16	0.108 - 0.629"	2.362"	1.457"	1.850-2.047"	1.575"	1.575"	SKG16-12HGE
NBT30-SK16C-75P	SK16	GH16	0.108 - 0.629"	2.953"	2.047"	1.772-2.047"	1.575"	1.575"	SKG16-10HG
NBT30-SK16C-90P	SK16	GH16	0.108 - 0.629"	3.543"	2.638"	1.772-2.244"	1.575"	1.575"	SKG16-12HG
NBT30-SK16C-120P	SK16	GH16	0.108 - 0.629"	4.724"	3.831"	1.299-1.614"	1.575"	1.575"	SKG16-12HG

BT 40

NBT40-SK16C-60P	SK16	GH16	0.108 - 0.629"	2.362"	1.260"	1.772-2.047"	1.575"	1.575"	SKG16-10HG
NBT40-SK16C-75P	SK16	GH16	0.108 - 0.629"	2.953"	1.693"	1.772-2.047"	1.575"	1.575"	SKG16-12HG
NBT40-SK16C-90P	SK16	GH16	0.108 - 0.629"	3.543"	2.283"	1.772-2.244"	1.575"	1.575"	SKG16-12HG
NBT40-SK16C-120P	SK16	GH16	0.108 - 0.629"	4.724"	3.465"	1.772-2.244"	1.575"	1.575"	SKG16-12HG
NBT40-SK16C-150P	SK16	GH16	0.108 - 0.629"	5.906"	4.646"	1.772-2.244"	1.575"	1.575"	SKG16-12HG

Part Number	Collet Series	Wrench	Clamping Range	L	R1	H	C	C1	Back Up Screw
-------------	---------------	--------	----------------	---	----	---	---	----	---------------

CAT 40

NCAT40-SK25C-90UP	SK25	GH25	0.629 - 1.0"	3.543"	2.793"	2.165-2.953"	2.165"	2.165"	SKG-28
NCAT40-SK25C-120UP	SK25	GH25	0.629 - 1.0"	4.724"	3.974"	2.165-2.953"	2.165"	2.165"	SKG-28

CAT 50

NCAT50-SK25C-105UP	SK25	GH25	0.629 - 1.0"	4.134"	3.384"	2.165-2.953"	2.165"	2.165"	SKG-28
NCAT50-SK25C-165UP	SK25	GH25	0.629 - 1.0"	6.496"	5.746"	2.165-2.953"	2.165"	2.165"	SKG-28

BT 30

NBT30-SK25-90P	SK25	GH25	0.629 - 1.0"	3.543"	2.638"	2.165-2.953"	2.165"	2.165"	SKG-12
----------------	------	------	--------------	--------	--------	--------------	--------	--------	--------

BT 40

NBT40-SK25C-75P	SK25	GH25	0.629 - 1.0"	2.953"	1.850"	2.362-2.559"	2.165"	2.165"	SKG25-18HGE
NBT40-SK25C-90P	SK25	GH25	0.629 - 1.0"	3.543"	2.402"	2.362-2.559"	2.165"	2.165"	SKG25-18HGD
NBT40-SK25C-120P	SK25	GH25	0.629 - 1.0"	4.724"	3.583"	2.362-2.756"	2.165"	2.165"	SKG25-24HG

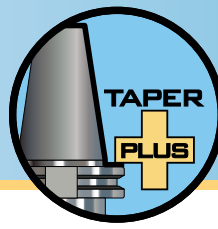

SK6 Collets

SK6 Collets - Metric	Collet Range	Collapse Range
SK6-0.8	0.7 - 0.8	0.027 - 0.031"
SK6-1	0.9 - 1.0	0.035 - 0.039"
SK6-1.25	1.15 - 1.25	0.045 - 0.049"
SK6-1.5	1.3 - 1.5	0.051 - 0.059"
SK6-1.75	1.5 - 1.75	0.059 - 0.068"
SK6-2	1.8 - 2.0	0.070 - 0.078"
SK6-2.25	2.05 - 2.25	0.080 - 0.088"
SK6-2.5	2.3 - 2.5	0.090 - 0.098"
SK6-2.75	2.55 - 2.75	0.100 - 0.108"
SK6-3	2.8 - 3.0	0.110 - 0.118"
SK6-3.5	3.0 - 3.5	0.118 - 0.137"
SK6-4	3.5 - 4.0	0.137 - 0.157"
SK6-4.5	4.0 - 4.5	0.157 - 0.177"
SK6-5	4.5 - 5.0	0.177 - 0.196"
SK6-5.5	5.0 - 5.5	0.196 - 0.216"
SK6-6	5.5 - 6.0	0.216 - 0.236"

SK6 Collets - Inch	Collet Size
SK6-1/8A	.125"
SK6-3/16A	.187"



SK Collet

SK10 Collets

SK10 Collets - Metric	Collet Range	Collapse Range
SK10-2	1.75 - 2.0	0.068 - 0.078"
SK10-2.25	2.0 - 2.25	0.078 - 0.088"
SK10-2.5	2.25 - 2.5	0.088 - 0.098"
SK10-2.75	2.5 - 2.75	0.098 - 0.108"
SK10-3	2.75 - 3.0	0.108 - 0.118"
SK10-3.5	3.0 - 3.5	0.118 - 0.137"
SK10-4	3.5 - 4.0	0.137 - 0.157"
SK10-4.5	4.0 - 4.5	0.157 - 0.177"
SK10-5	4.5 - 5.0	0.177 - 0.196"
SK10-5.5	5.0 - 5.5	0.196 - 0.216"
SK10-6	5.5 - 6.0	0.216 - 0.236"
SK10-6.5	6.0 - 6.5	0.236 - 0.255"
SK10-7	6.5 - 7.0	0.255 - 0.275"
SK10-7.5	7.0 - 7.5	0.275 - 0.295"
SK10-8	7.5 - 8.0	0.295 - 0.314"
SK10-8.5	8.0 - 8.5	0.314 - 0.334"
SK10-9	8.5 - 9.0	0.334 - 0.354"
SK10-9.5	9.0 - 9.5	0.354 - 0.374"
SK10-10	9.5 - 10.0	0.374 - 0.393"

SK10 Collets - Inch	Collet Size
SK10-1/8A	0.125"
SK10-3/16A	0.187"
SK10-1/4A	0.25"
SK10-5/16A	0.312"
SK10-3/8A	0.375"

SK10 Coolant Collets

SK10 Coolant Collets - Inch	Collet Size
SK10-1/4AC	0.25"
SK10-5/16AC	0.312"
SK10-3/8AC	0.375"
SK10-6AC	6mm
SK10-7AC	7mm
SK10-8AC	8mm
SK10-9AC	9mm
SK10-10AC	10mm

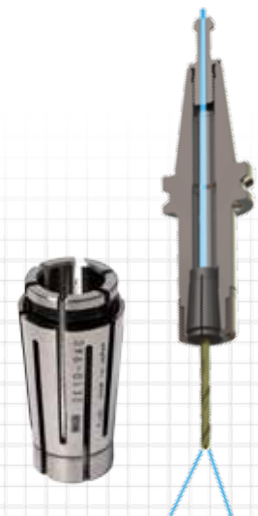

Mechanically sealing up to 1200 psi

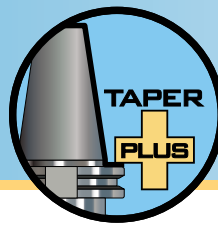

SK16 Collets

SK16 Collets - Metric	Collet Range	Collapse Range
SK16-3	2.75 - 3.0	0.108 - 0.118"
SK16-3.5	3.0 - 3.5	0.118 - 0.137"
SK16-4	3.5 - 4.0	0.137 - 0.157"
SK16-4.5	4.0 - 4.5	0.157 - 0.177"
SK16-5	4.5 - 5.0	0.177 - 0.196"
SK16-5.5	5.0 - 5.5	0.196 - 0.216"
SK16-6	5.5 - 6.0	0.216 - 0.236"
SK16-6.5	6.0 - 6.5	0.236 - 0.255"
SK16-7	6.5 - 7.0	0.255 - 0.275"
SK16-7.5	7.0 - 7.5	0.275 - 0.295"
SK16-8	7.5 - 8.0	0.295 - 0.314"
SK16-8.5	8.0 - 8.5	0.314 - 0.334"
SK16-9	8.5 - 9.0	0.334 - 0.354"
SK16-9.5	9.0 - 9.5	0.354 - 0.374"
SK16-10	9.5 - 10.0	0.374 - 0.393"
SK16-10.5	10.0 - 10.5	0.393 - 0.413"
SK16-11	10.5 - 11.0	0.413 - 0.433"
SK16-11.5	11.0 - 11.5	0.433 - 0.452"
SK16-12	11.5 - 12.0	0.452 - 0.472"
SK16-12.5	12.0 - 12.5	0.472 - 0.492"
SK16-13	12.5 - 13.0	0.492 - 0.511"
SK16-13.5	13.0 - 13.5	0.511 - 0.531"
SK16-14	13.5 - 14.0	0.531 - 0.551"
SK16-14.5	14.0 - 14.5	0.551 - 0.570"
SK16-15	14.5 - 15.0	0.570 - 0.590"
SK16-15.5	15.0 - 15.5	0.590 - 0.610"
SK16-16	15.5 - 16.0	0.610 - 0.629"

SK16 Collets - Inch	Collet Size
SK16-1/8A	0.125"
SK16-3/16A	0.187"
SK16-1/4A	0.25"
SK16-5/16A	0.312"
SK16-3/8A	0.375"
SK16-7/16A	0.437"
SK16-1/2A	0.5"
SK16-9/16A	0.562"
SK16-5/8A	0.625"



SK Collet

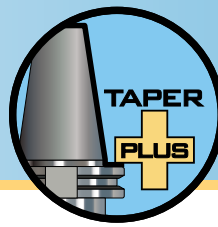

SK25 Collets

SK25 Collets - Metric	Collet Range	Collapse Range
SK25-16.5	16.0 - 16.5	0.629 - 0.649"
SK25-17	16.5 - 17.0	0.649 - 0.669"
SK25-17.5	17.0 - 17.5	0.669 - 0.688"
SK25-18	17.5 - 18.0	0.688 - 0.708"
SK25-18.5	18.0 - 18.5	0.708 - 0.728"
SK25-19	18.5 - 19.0	0.728 - 0.748"
SK25-19.5	19.0 - 19.5	0.748 - 0.767"
SK25-20	19.5 - 20.0	0.767 - 0.787"
SK25-20.5	20.0 - 20.5	0.787 - 0.807"
SK25-21	20.5 - 21.0	0.807 - 0.826"
SK25-21.5	21.0 - 21.5	0.826 - 0.846"
SK25-22	21.5 - 22.0	0.846 - 0.866"
SK25-22.5	22.0 - 22.5	0.866 - 0.885"
SK25-23	22.5 - 23.0	0.885 - 0.905"
SK25-23.5	23.0 - 23.5	0.905 - 0.925"
SK25-24	23.5 - 24.0	0.925 - 0.944"
SK25-24.5	24.0 - 24.5	0.944 - 0.964"
SK25-25	24.5 - 25.0	0.964 - 0.984"
SK25-25.4	25.0 - 25.4	0.984 - 1.0"

SK25 Collets - Inch	Collet Size
SK25-3/16A	0.187"
SK25-1/4A	0.25"
SK25-5/16A	0.312"
SK25-3/8A	0.375"
SK25-7/16A	0.437"
SK25-1/2A	0.5"
SK25-5/8A	0.625"
SK25-3/4A	0.75"

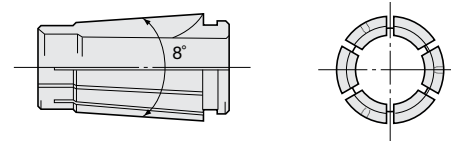

SK Collet

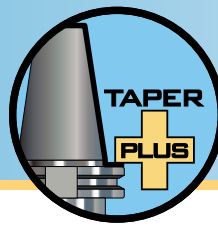

SK Coolant Collet System



Collet Chuck	Collet Series	Coolant Nut Part Number	High-Speed Coolant Nut Part #	Cutting Tool Size	Coolant-Thru Disk Part #	Slotted Disk Part #	Disk Wrench Part #	Blank Disk (machinable) Part #
SK6	SK6-range: 0.7-6.0mm (0.027-0.236")	SKN-6WBJ	SKN-6WBJ(GH)	3mm	SKJ6-3C	SKJ6-3	SKJL-6	SKJ6-BLANK
				4mm	SKJ6-4C	SKJ6-4		
				5mm	SKJ6-5C	SKJ6-5		
				6mm	SKJ6-6C	SKJ6-6		
				1/8"	SKJ6-1/8C	SKJ6-1/8		
				3/16"	SKJ6-3/16C	SKJ6-3/16		
SK10	SK10-range: 1.75-10.0mm (0.068-0.393")	SKN-10BJ	SKN-10BJ(GH)	3mm	SKJ10-3C	SKJ10-3	SKJL-10	SKJ10-BLANK
				4mm	SKJ10-4C	SKJ10-4		
				5mm	SKJ10-5C	SKJ10-5		
				6mm	SKJ10-6C	SKJ10-6		
				8mm	SKJ10-8C	SKJ10-8		
				10mm	SKJ10-10C	SKJ10-10		
				1/8"	SKJ10-1/8C	SKJ10-1/8		
				3/16"	SKJ10-3/16C	SKJ10-3/16		
				1/4"	SKJ10-1/4C	SKJ10-1/4		
				5/16"	SKJ10-5/16C	SKJ10-5/16		
SK16	SK16-range: 2.75-16.0mm (0.108-0.629")	SKN-16BJ	SKN-16BJ(GH)	6mm	SKJ16-6C	SKJ16-6	SKJL-16	SKJ16-BLANK
				8mm	SKJ16-8C	SKJ16-8		
				10mm	SKJ16-10C	SKJ16-10		
				12mm	SKJ16-12C	SKJ16-12		
				16mm	SKJ16-16C	SKJ16-16		
				1/4"	SKJ16-1/4C	SKJ16-1/4		
				5/16"	SKJ16-5/16C	SKJ16-5/16		
				3/8"	SKJ16-3/8C	SKJ16-3/8		
				7/16"	SKJ16-7/16C	SKJ16-7/16		
				1/2"	SKJ16-1/2C	SKJ16-1/2		
				9/16"	SKJ16-9/16C	SKJ16-9/16		
SK25	SK25-range: 16.0-25.4mm (0.629-1.0")	SKN-25BJ	SKN-25BJ(GH)	16mm	SKJ25-16C	SKJ25-16	SKJL-25	SKJ25-BLANK
				20mm	SKJ25-20C	SKJ25-20		
				25mm	SKJ25-25C	SKJ25-25		
				5/8"	SKJ25-5/8C	SKJ25-5/8		
				11/16"	SKJ25-11/16C	SKJ25-11/16		
				3/4"	SKJ25-3/4C	SKJ25-3/4		
				13/16"	SKJ25-13/16C	SKJ25-13/16		
				7/8"	SKJ25-7/8C	SKJ25-7/8		
				15/16"	SKJ25-15/16C	SKJ25-15/16		
				1"	SKJ25-1C	SKJ25-1		

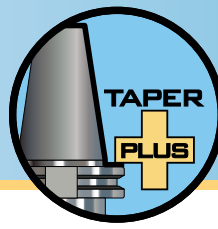

SK Collet Chuck Accessories

SK Collet Extractor

Part Number	Description
SKR-6	SK6 Collet Extractor
SKR-10	SK10 Collet Extractor
SKR-16	SK16 Collet Extractor
SKR-25	SK25 Collet Extractor



Replacement Nut for SK Collet Chuck - Standard Style

Part Number	Description
SKN-6WB	Nut for SK6 Collet Chuck
SKN-10B	Nut for SK10 Collet Chuck
SKN-16B	Nut for SK16 Collet Chuck
SKN-25B	Nut for SK25 Collet Chuck

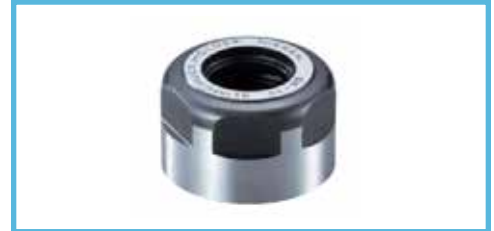

Replacement Nut for SK Collet Chuck - High-Speed Style

Part Number	Description
SKN-6WB (GH)	Nut for SK6 High-Speed Collet Chuck
SKN-10B (GH)	Nut for SK10 High-Speed Collet Chuck
SKN-16B (GH)	Nut for SK16 High-Speed Collet Chuck
SKN-25B (GH)	Nut for SK25 High-Speed Collet Chuck



Wrench for SK Collet Chuck - Standard Style

Part Number	Description
SKL-6W	Wrench for SK6 Collet Chuck
SKL-10	Wrench for SK10 Collet Chuck
9HC16	Wrench for SK16 Collet Chuck
9HC22	Wrench for SK25 Collet Chuck



Wrench for SK Collet Chuck - High-Speed Style

Part Number	Description
GH6	Wrench for SK6 High-Speed Collet Chuck
GH10	Wrench for SK10 High-Speed Collet Chuck
GH16	Wrench for SK16 High-Speed Collet Chuck
GH25	Wrench for SK25 High-Speed Collet Chuck



Torque Wrench and Attachment for SK Collet Chuck

Part Number	Description
TQW-025	Torque wrench for SK6 Collet Chuck Nut
TQW-150	Torque wrench for SK10/16/25 Collet Chuck Nut
TQW-SK06(18)	SK6 attachment for TQW-025 torque wrench
TQW-SK10(1)	SK10 attachment for TQW-0150 torque wrench
TQW-SK16(43)	SK16 attachment for TQW-0150 torque wrench
TQW-SK25(60)	SK25 attachment for TQW-0150 torque wrench



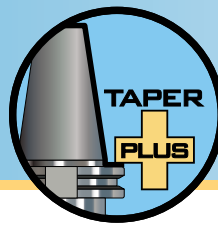

End Mill Holders

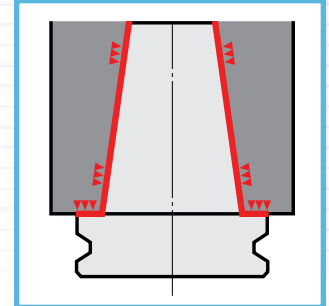
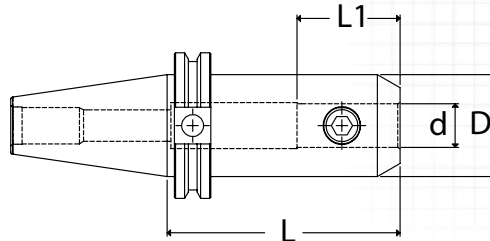

Part Number	d	L	L1	D	Set Screw Part Number
-------------	---	---	----	---	-----------------------

CAT 40

NC4006-0500-2.50	1/2"	2.50"	1.50"	1.38"	S7/16-20X3/8
NC4006-0625-3.00	5/8"	3.00"	1.61"	1.65"	S9/16-18X1/2
NC4006-0750-3.00	3/4"	3.00"	1.77"	1.75"	S5/8-18X1/2
NC4006-1000-4.00	1"	4.00"	2.36"	2.36"	S3/4-16X11/16 (2)
NC4006-1250-4.00	1-1/4"	4.00"	2.55"	2.48"	S3/4-16X11/16 (2)
NC4006-1500-4.50	1-1/2"	4.50"	2.55"	2.99"	S3/4-16X11/16 (2)
NC4016-0500-4.00	1/2"	4.00"	1.50"	1.38"	S7/16-20X3/8
NC4016-0750-4.00	3/4"	4.00"	1.77"	1.75"	S5/8-18X1/2
NC4026-0500-5.00	1/2"	5.00"	1.50"	1.38"	S7/16-20X3/8

CAT 50

NC5006-0500-2.63	1/2"	2.63"	1.50"	1.38"	S7/16-20X3/8
NC5006-0625-3.00	5/8"	3.00"	1.61"	1.65"	S9/16-18X1/2
NC5006-0750-3.00	3/4"	3.00"	1.77"	1.89"	S5/8-18X1/2
NC5006-1000-4.00	1"	4.00"	2.36"	2.36"	S3/4-16X11/16 (2)
NC5006-1250-3.00A*	1-1/4"	3.00"	2.27"	2.87"	S3/4-16X7/8
NC5006-1250-4.00	1-1/4"	4.00"	2.55"	2.48"	S3/4-16X11/16 (2)
NC5006-1500-4.50	1-1/2"	4.50"	2.83"	2.99"	S3/4-16X11/16 (2)
NC5006-2000-5.35A*	2"	5.35"	3.38"	4.00"	S3/4-16X7/8 (2)
NC5006-2000-5.37	2"	5.37"	3.34"	3.74"	S1"-14x7/8 (2)
NC5006-2500-5.35A*	2-1/2"	5.35"	3.38"	5.00"	S3/4-16X7/8(2)
NC5006-2500-6.00	2-1/2"	6.00"	3.66"	4.25"	S1"-14x7/8 (2)
NC5006-32-4.00	32mm	4.00"	2.55"	2.48"	S3/4-16X11/16 (2)
NC5006-40-4.50	40mm	4.50"	2.95"	3.07"	S3/4-16X11/16 (2)
NC5006-50-5.37	50mm	5.37"	3.35"	3.74"	S1"-14X7/8 (2)
NC5016-0500-4.00	1/2"	4.00"	1.50"	1.38"	S7/16-20X3/8
NC5016-0625-4.00	5/8"	4.00"	1.61"	1.65"	S9/16-18X1/2
NC5016-0750-4.00	3/4"	4.00"	1.77"	1.89"	S5/8-18X1/2
NC5016-1000-6.00	1"	6.00"	2.36"	2.36"	S3/4-16X11/16 (2)
NC5016-1250-6.00	1-1/4"	6.00"	2.55"	2.48"	S3/4-16X11/16 (2)
NC5026-0750-6.00	3/4"	6.00"	1.77"	1.89"	S5/8-18X1/2

* Non-stocking item. Please contact us for more information.

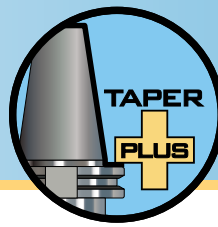

End Mill Accessories

Replacement Set Screws for End Mill Holders

Part Number	Size of Holder Internal Diameter
S6-32X1/4	1/8"
S8-32X1/4	3/16"
S1-14x7/8	2", 2-1/2"
S1/4-28x1/4	1/4", 6mm
S5/16-24X1/4	5/16", 8mm
S3/8-24X5/16	3/8", 7/16", 10mm
S7/16-20X3/8	1/2", 12mm
S9/16-18X1/2	5/8", 14-16mm
S5/8-18X1/2	3/4", 7/8", 18-20mm
S3/4-16X11/16	1", 1-1/4", 1-1/2", 25-42mm



Replacement Set Screws for Aerospace End Mill Holders

Part Number	Size of Holder Internal Diameter
S3/4-16x7/8	1", 1-1/4", 1-1/2", 2", 2-1/2"
S1/2-20UNF	5/8", 3/4", 7/8"
S3/8-24UNF	3/8", 1/2"



ToolJaw® - The Toolholder Clamp Champ

Description	ToolJaw® Clamps	Replacement Keys	Replacement Jaws
	Part Number	Part Number	Part Number
CT 40-Taper TOOLJAW	C40-TOOLJAW	C40-KEY	C40-JAW
CT 50-Taper TOOLJAW	C50-TOOLJAW	C50-KEY	C50-JAW



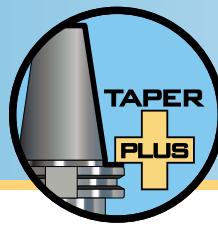

FMD - Face / Shell Mill Holder

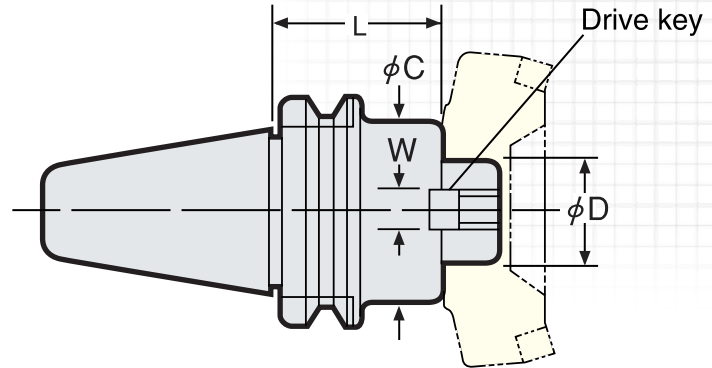

Part Number	L	C	D	Drive Key (W)
CAT 40				
NC4001-0750-1.75	1.75"	1.929"	0.750"	0.3125"
NC4001-1000-1.75	1.75"	2.382"	1.000"	0.375"
NC4001-1250-2.00	2.00"	2.882"	1.250"	0.500"
NC4001-1500-2.00	2.00"	3.799"	1.500"	0.625"
NC4011-0750-4.00	4.00"	1.929"	0.750"	0.3125"
NC4011-1000-4.00	4.00"	2.382"	1.000"	0.375"
NC4011-1250-4.00	4.00"	2.882"	1.250"	0.500"
CAT 50				
NC5001-0750-1.75	1.75"	1.929"	0.750"	0.3125"
NC5001-1000-1.75	1.75"	2.382"	1.000"	0.375"
NC5001-1250-1.75	1.75"	2.882"	1.250"	0.500"
NC5001-1500-2.00	2.00"	3.799"	1.500"	0.625"
NC5001-2000-2.00	2.00"	4.382"	2.000"	0.750"
NC5011-0750-4.00	4.00"	1.929"	0.750"	0.3125"
NC5011-1000-4.00	4.00"	2.382"	1.000"	0.375"
NC5011-1250-4.00	4.00"	2.882"	1.250"	0.500"
NC5011-1500-4.00	4.00"	3.799"	1.500"	0.625"
NC5021-0750-6.00	6.00"	1.929"	0.750"	0.3125"
NC5021-1000-6.00	6.00"	2.382"	1.000"	0.375"
NC5021-1250-6.00	6.00"	2.882"	1.250"	0.500"
NC5021-1500-6.00	6.00"	3.799"	1.500"	0.625"
NC5031-0750-8.00	8.00"	1.929"	0.750"	0.3125"
NC5031-1000-8.00	8.00"	2.382"	1.000"	0.375"
NC5031-1500-8.00	8.00"	3.799"	1.500"	0.625"
NC50F1-2500-2.95	2.95"	5.000"	2.500"	1.000"
BT 30				
NB3001-0750-1.19	1.19"	1.929"	0.750"	0.3125"
NB3001-1000-1.19	1.19"	2.382"	1.000"	0.375"

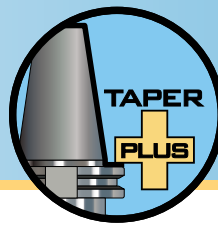

CAT40 Shrink Fit Holders

COOLANT PORT FEATURES

- high pressure coolant allows for fast chip evacuation
- 1000 psi coolant capable



Standard Type

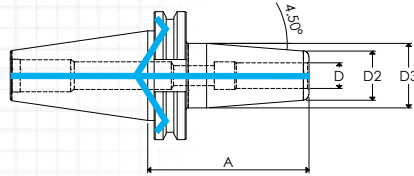

Part Number	D	A	D2	D3
-------------	---	---	----	----

CAT40 Standard

NCAT40-SF0125-3.15	1/8"	3.15"	0.39"	0.71"
NCAT40-SF0187-3.15	3/16"	3.15"	0.39"	0.63"
NCAT40-SF0250-3.15	1/4"	3.15"	0.83"	1.06"
NCAT40-SF0375-3.15	3/8"	3.15"	0.94"	1.26"
NCAT40-SF0500-3.15	1/2"	3.15"	0.94"	1.26"
NCAT40-SF0625-3.15	5/8"	3.15"	1.06"	1.34"
NCAT40-SF0750-3.15	3/4"	3.15"	1.30"	1.65"
NCAT40-SF1000-3.94	1"	3.94"	1.73"	2.09"

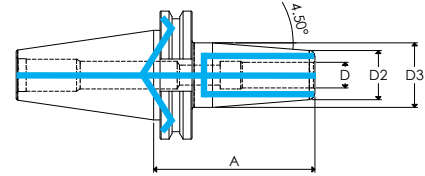

Part Number	D	A	D2	D3
-------------	---	---	----	----

CAT40 Standard Coolant Ported

NCAT40-SF0250-3.15CP	1/4"	3.15"	0.83"	1.06"
NCAT40-SF0312-3.15CP	5/16"	3.15"	0.79"	1.06"
NCAT40-SF0375-3.15CP	3/8"	3.15"	0.94"	1.26"
NCAT40-SF0500-3.15CP	1/2"	3.15"	0.94"	1.26"
NCAT40-SF0625-3.15CP	5/8"	3.15"	1.06"	1.34"
NCAT40-SF0750-3.15CP	3/4"	3.15"	1.30"	1.65"
NCAT40-SF1000-3.94CP	1"	3.94"	1.73"	2.09"

Extended Type

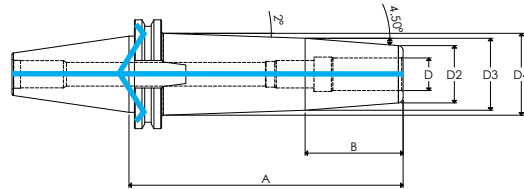
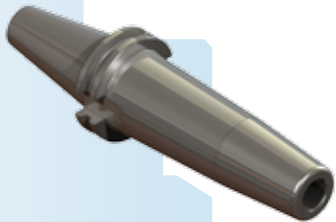

Part Number	D	A	D2	D3	D4	B
-------------	---	---	----	----	----	---

CAT40 Extended

NCAT40-SF0125-5.12	1/8"	5.12"	0.35"	0.71"	0.85"	2.25"
NCAT40-SF0125-6.30	1/8"	6.30"	0.39"	0.63"	1.26"	1.50"
NCAT40-SF0187-5.12	3/16"	5.12"	0.39"	0.87"	0.96"	3.00"
NCAT40-SF0250-5.12	1/4"	5.12"	0.83"	1.06"	1.26"	1.50"
NCAT40-SF0250-6.30	1/4"	6.30"	0.83"	1.06"	1.35"	1.50"
NCAT40-SF0375-5.12	3/8"	5.12"	0.94"	1.26"	1.43"	2.00"
NCAT40-SF0375-6.30	3/8"	6.30"	0.94"	1.26"	1.51"	2.00"
NCAT40-SF0500-5.12	1/2"	5.12"	0.94"	1.26"	1.43"	2.00"
NCAT40-SF0500-6.30	1/2"	6.30"	0.94"	1.26"	1.51"	2.00"
NCAT40-SF0625-5.12	5/8"	5.12"	1.06"	1.34"	1.60"	1.75"
NCAT40-SF0625-6.30	5/8"	6.30"	1.06"	1.34"	1.60"	1.75"
NCAT40-SF0750-5.12	3/4"	5.12"	1.30"	1.65"	1.80"	2.25"
NCAT40-SF0750-6.30	3/4"	6.30"	1.30"	1.65"	1.88"	2.25"
NCAT40-SF1000-5.12	1"	5.12"	1.73"	2.09"	2.23"	2.25"
NCAT40-SF1000-6.30	1"	6.30"	1.73"	2.09"	2.32"	2.25"

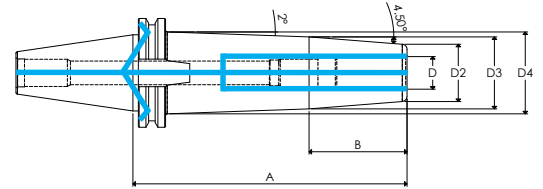

Part Number	D	A	D2	D3	D4	B
-------------	---	---	----	----	----	---

CAT40 Extended Coolant Ported

NCAT40-SF0250-5.12CP	1/4"	5.12"	0.83"	1.06"	1.26"	1.50"
NCAT40-SF0250-6.30CP	1/4"	6.30"	0.83"	1.06"	1.35"	1.50"
NCAT40-SF0375-5.12CP	3/8"	5.12"	0.94"	1.26"	1.43"	2.00"
NCAT40-SF0375-6.30CP	3/8"	6.30"	0.94"	1.26"	1.51"	2.00"
NCAT40-SF0500-5.12CP	1/2"	5.12"	0.94"	1.26"	1.43"	2.00"
NCAT40-SF0500-6.30CP	1/2"	6.30"	0.94"	1.26"	1.51"	2.00"
NCAT40-SF0625-5.12CP	5/8"	5.12"	1.06"	1.34"	1.60"	1.75"
NCAT40-SF0625-6.30CP	5/8"	6.30"	1.06"	1.34"	1.60"	1.75"
NCAT40-SF0750-5.12CP	3/4"	5.12"	1.30"	1.65"	1.80"	2.25"
NCAT40-SF0750-6.30CP	3/4"	6.30"	1.30"	1.65"	1.88"	2.25"
NCAT40-SF1000-5.12CP	1"	5.12"	1.73"	2.09"	2.23"	2.25"
NCAT40-SF1000-6.30CP	1"	6.30"	1.73"	2.09"	2.32"	2.25"

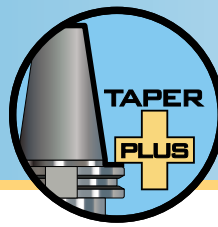

CAT50 Shrink Fit Holders

COOLANT PORT FEATURES

- high pressure coolant allows for fast chip evacuation
- 1000 psi coolant capable



Standard Type

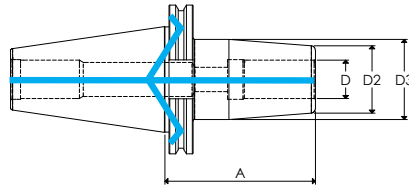

Part Number	D	A	D2	D3
-------------	---	---	----	----

CAT50 Standard

NCAT50-SF0125-3.15	1/8"	3.15"	0.39"	0.71"
NCAT50-SF0250-3.15	1/4"	3.15"	0.83"	1.06"
NCAT50-SF0375-3.15	3/8"	3.15"	0.94"	1.26"
NCAT50-SF0500-3.15	1/2"	3.15"	0.94"	1.26"
NCAT50-SF0625-3.15	5/8"	3.15"	1.06"	1.34"
NCAT50-SF0750-3.15	3/4"	3.15"	1.30"	1.65"
NCAT50-SF1000-3.94	1"	3.94"	1.73"	2.09"
NCAT50-SF1250-3.94	1.1/4"	3.94"	1.73"	2.09"

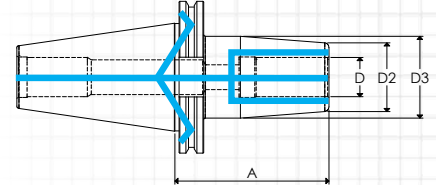

Part Number	D	A	D2	D3
-------------	---	---	----	----

CAT50 Standard Coolant

NCAT50-SF0250-3.15CP	1/4"	3.15"	0.83"	1.06"
NCAT50-SF0375-3.15CP	3/8"	3.15"	0.94"	1.26"
NCAT50-SF0500-3.15CP	1/2"	3.15"	0.94"	1.26"
NCAT50-SF0625-3.15CP	5/8"	3.15"	1.06"	1.34"
NCAT50-SF0750-3.15CP	3/4"	3.15"	1.30"	1.65"
NCAT50-SF1000-3.94CP	1"	3.94"	1.73"	2.09"
NCAT50-SF1250-3.94CP	1.25"	3.94"	1.73"	2.09"

Extended Type

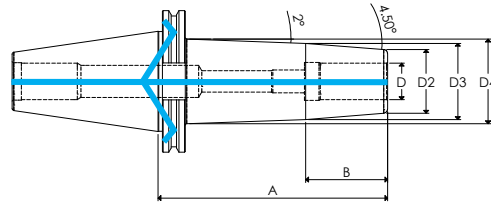

Part Number	D	A	D2	D3	D4	B
-------------	---	---	----	----	----	---

CAT50 Extended

NCAT50-SF0125-6.30	1/8"	6.30"	0.39"	0.71"	0.99"	1.50"
NCAT50-SF0250-5.12	1/4"	5.12"	0.83"	1.06"	1.26"	1.50"
NCAT50-SF0250-6.30	1/4"	6.30"	0.83"	1.06"	1.35"	1.50"
NCAT50-SF0375-5.12	3/8"	5.12"	0.94"	1.26"	1.43"	2.00"
NCAT50-SF0375-6.30	3/8"	6.30"	0.94"	1.26"	1.51"	2.00"
NCAT50-SF0500-5.12	1/2"	5.12"	0.94"	1.26"	1.43"	2.00"
NCAT50-SF0500-6.30	1/2"	6.30"	0.94"	1.26"	1.51"	2.00"
NCAT50-SF0625-5.12	5/8"	5.12"	1.06"	1.34"	1.52"	1.75"
NCAT50-SF0625-6.30	5/8"	6.30"	1.06"	1.34"	1.60"	1.75"
NCAT50-SF0750-5.12	3/4"	5.12"	1.30"	1.65"	1.80"	2.25"
NCAT50-SF0750-6.30	3/4"	6.30"	1.30"	1.65"	1.88"	2.25"
NCAT50-SF1000-5.12	1"	5.12"	1.73"	2.09"	2.23"	2.25"
NCAT50-SF1000-6.30	1"	6.30"	1.73"	2.09"	2.32"	2.25"
NCAT50-SF1250-5.12	1.1/4"	5.12"	1.73"	2.09"	2.23"	2.25"
NCAT50-SF1250-6.30	1.1/4"	6.30"	1.73"	2.09"	2.32"	2.25"

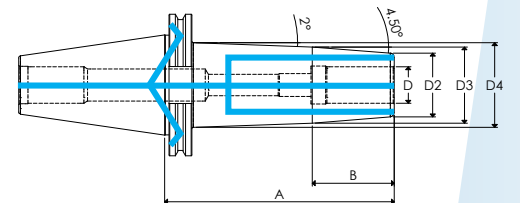

Part Number	D	A	D2	D3	D4	B
-------------	---	---	----	----	----	---

CAT50 Extended Coolant

NCAT50-SF0250-5.12CP	1/4"	5.12"	0.83"	1.06"	1.26"	1.50"
NCAT50-SF0250-6.30CP	1/4"	6.30"	0.83"	1.06"	1.35"	1.50"
NCAT50-SF0375-5.12CP	3/8"	5.12"	0.94"	1.26"	1.43"	2.00"
NCAT50-SF0375-6.30CP	3/8"	6.30"	0.94"	1.26"	1.51"	2.00"
NCAT50-SF0500-5.12CP	1/2"	5.12"	0.94"	1.26"	1.43"	2.00"
NCAT50-SF0500-6.30CP	1/2"	6.30"	0.94"	1.26"	1.51"	2.00"
NCAT50-SF0625-5.12CP	5/8"	5.12"	1.06"	1.34"	1.52"	1.75"
NCAT50-SF0625-6.30CP	5/8"	6.30"	1.06"	1.34"	1.60"	1.75"
NCAT50-SF0750-5.12CP	3/4"	5.12"	1.30"	1.65"	1.80"	2.25"
NCAT50-SF0750-6.30CP	3/4"	6.30"	1.30"	1.65"	1.88"	2.25"
NCAT50-SF1000-5.12CP	1"	5.12"	1.73"	2.09"	2.23"	2.25"
NCAT50-SF1000-6.30CP	1"	6.30"	1.73"	2.09"	2.32"	2.25"
NCAT50-SF1250-5.12CP	1.1/4"	5.12"	1.73"	2.09"	2.23"	2.25"
NCAT50-SF1250-6.30CP	1.1/4"	6.30"	1.73"	2.09"	2.32"	2.25"

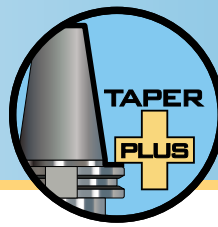

BT30/40 Shrink Fit Holders

COOLANT PORT FEATURES

- high pressure coolant allows for fast chip evacuation
- 1000 psi coolant capable



Standard Type

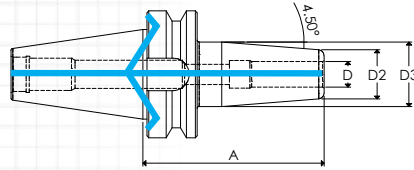

Part Number	D	A	D2	D3
-------------	---	---	----	----

BT30 Standard

NBT30-SF0125-3.15	1/8"	3.15"	0.39"	0.71"
NBT30-SF0187-3.15	3/16"	3.15"	0.39"	0.63"
NBT30-SF0250-3.15	1/4"	3.15"	0.83"	1.06"
NBT30-SF0375-3.15	3/8"	3.15"	0.94"	1.22"
NBT30-SF0500-3.15	1/2"	3.15"	0.94"	1.22"
NBT30-SF0625-3.15	5/8"	3.15"	1.06"	1.34"
NBT30-SF0750-3.15	3/4"	3.15"	1.30"	1.54"

BT40 Standard

NBT40-SF0125-3.54	1/8"	3.54"	0.39"	0.71"
NBT40-SF0250-3.54	1/4"	3.54"	0.79"	1.06"
NBT40-SF0375-3.54	3/8"	3.54"	0.94"	1.26"
NBT40-SF0500-3.54	1/2"	3.54"	0.94"	1.26"
NBT40-SF0625-3.54	5/8"	3.54"	1.06"	1.34"
NBT40-SF0750-3.54	3/4"	3.54"	1.30"	1.65"
NBT40-SF1000-3.94	1"	3.94"	1.73"	2.09"

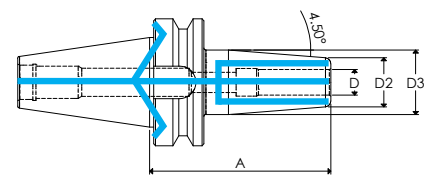

Part Number	D	A	D2	D3
-------------	---	---	----	----

BT30 Standard Coolant

NBT30-SF0250-3.15CP	1/4"	3.15"	0.83"	1.06"
NBT30-SF0375-3.15CP	3/8"	3.15"	0.94"	1.22"
NBT30-SF0500-3.15CP	1/2"	3.15"	0.94"	1.22"
NBT30-SF0625-3.15CP	5/8"	3.15"	1.06"	1.34"
NBT30-SF0750-3.15CP	3/4"	3.15"	1.30"	1.54"

BT40 Standard Coolant

NBT40-SF0250-3.54CP	1/4"	3.54"	0.79"	1.06"
NBT40-SF0375-3.54CP	3/8"	3.54"	0.94"	1.26"
NBT40-SF0500-3.54CP	1/2"	3.54"	0.94"	1.26"
NBT40-SF0625-3.54CP	5/8"	3.54"	1.06"	1.34"
NBT40-SF0750-3.54CP	3/4"	3.54"	1.30"	1.65"
NBT40-SF1000-3.94CP	1"	3.94"	1.73"	2.09"

Extended Type

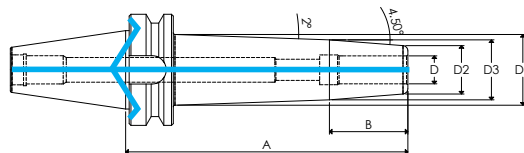
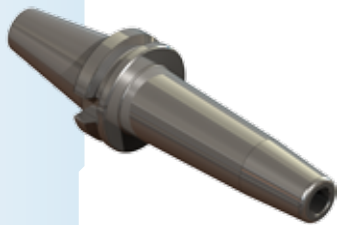

Part Number	D	A	D2	D3	D4	B
-------------	---	---	----	----	----	---

BT40 Extended

NBT40-SF0125-6.30	1/8"	6.30"	0.39"	0.71"	1.32"	1.50"
NBT40-SF0250-6.30	1/4"	6.30"	0.79"	1.06"	1.32"	1.50"
NBT40-SF0375-6.30	3/8"	6.30"	0.94"	1.26"	1.49"	2.00"
NBT40-SF0500-6.30	1/2"	6.30"	0.94"	1.26"	1.49"	2.00"
NBT40-SF0625-6.30	5/8"	6.30"	1.06"	1.34"	1.58"	1.75"
NBT40-SF0750-6.30	3/4"	6.30"	1.30"	1.65"	1.86"	2.25"
NBT40-SF1000-6.30	1"	6.30"	1.73"	2.09"	2.30"	2.25"

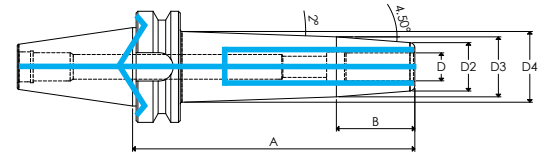

Part Number	D	A	D2	D3	D4	B
-------------	---	---	----	----	----	---

BT40 Extended Coolant

NBT40-SF0250-6.30CP	1/4"	6.30"	0.79"	1.06"	1.32"	1.50"
NBT40-SF0375-6.30CP	3/8"	6.30"	0.94"	1.26"	1.49"	2.00"
NBT40-SF0500-6.30CP	1/2"	6.30"	0.94"	1.26"	1.49"	2.00"
NBT40-SF0625-6.30CP	5/8"	6.30"	1.06"	1.34"	1.58"	1.75"
NBT40-SF0750-6.30CP	3/4"	6.30"	1.30"	1.65"	1.86"	2.25"
NBT40-SF1000-6.30CP	1"	6.30"	1.73"	2.09"	2.30"	2.25"

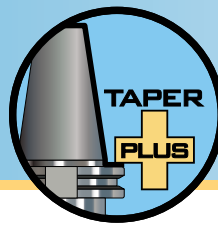

BT50 Shrink Fit Holders

COOLANT PORT FEATURES

- high pressure coolant allows for fast chip evacuation
- 1000 psi coolant capable



Standard Type

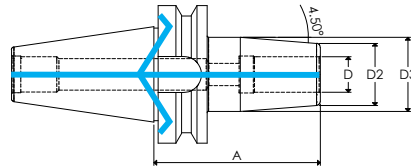

Part Number	D	A	D2	D3
-------------	---	---	----	----

BT50 Standard

NBT50-SF0125-3.94*	1/8"	3.94"	0.39"	0.71"
NBT50-SF0250-3.94*	1/4"	3.94"	0.79"	1.06"
NBT50-SF0375-3.94*	3/8"	3.94"	0.94"	1.26"
NBT50-SF0500-3.94*	1/2"	3.94"	0.94"	1.26"
NBT50-SF0625-3.94*	5/8"	3.94"	1.06"	1.34"
NBT50-SF0750-3.94*	3/4"	3.94"	1.30"	1.65"
NBT50-SF1000-3.94*	1"	3.94"	1.73"	2.09"
NBT50-SF1250-3.94*	1.1/4"	3.94"	1.73"	2.09"

*Pricing on Request

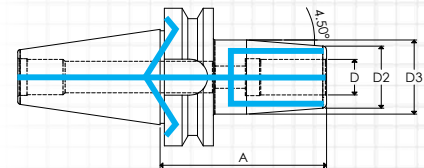

Part Number	D	A	D2	D3
-------------	---	---	----	----

BT50 Standard Coolant

NBT50-SF0250-3.94CP*	1/4"	3.94"	0.79"	1.06"
NBT50-SF0375-3.94CP*	3/8"	3.94"	0.94"	1.26"
NBT50-SF0500-3.94CP*	1/2"	3.94"	0.94"	1.26"
NBT50-SF0625-3.94CP*	5/8"	3.94"	1.06"	1.34"
NBT50-SF0750-3.94CP*	3/4"	3.94"	1.30"	1.65"
NBT50-SF1000-3.94CP*	1"	3.94"	1.73"	2.09"
NBT50-SF1250-3.94CP*	1.1/4"	3.94"	1.73"	2.09"

*Pricing on Request

Extended Type

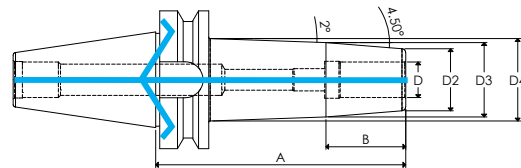

Part Number	D	A	D2	D3	D4	B
-------------	---	---	----	----	----	---

BT50 Extended

NBT50-SF0125-6.30*	1/8"	6.30"	0.39"	1.15"	1.32"	1.50"
NBT50-SF0250-6.30*	1/4"	6.30"	0.79"	1.06"	1.32"	1.50"
NBT50-SF0375-6.30*	3/8"	6.30"	0.94"	1.26"	1.32"	1.50"
NBT50-SF0500-6.30*	1/2"	6.30"	0.94"	1.26"	1.49"	2.00"
NBT50-SF0625-6.30*	5/8"	6.30"	1.06"	1.34"	1.49"	2.00"
NBT50-SF0750-6.30*	3/4"	6.30"	1.30"	1.65"	1.78"	1.75"
NBT50-SF1000-6.30*	1"	6.30"	1.73"	2.09"	2.29"	2.25"
NBT50-SF1250-6.30*	1.1/4"	6.30"	1.73"	2.09"	2.30"	2.25"

*Pricing on Request

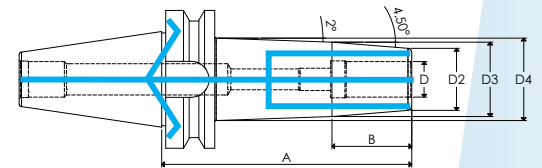

Part Number	D	A	D2	D3	D4	B
-------------	---	---	----	----	----	---

BT50 Extended Coolant

NBT50-SF0250-6.30CP*	1/4"	6.30"	0.79"	1.06"	1.32"	1.50"
NBT50-SF0375-6.30CP*	3/8"	6.30"	0.94"	1.26"	1.32"	1.50"
NBT50-SF0500-6.30CP*	1/2"	6.30"	0.94"	1.26"	1.49"	2.00"
NBT50-SF0625-6.30CP*	5/8"	6.30"	1.06"	1.34"	1.49"	2.00"
NBT50-SF0750-6.30CP*	3/4"	6.30"	1.30"	1.65"	1.78"	1.75"
NBT50-SF1000-6.30CP*	1"	6.30"	1.73"	2.09"	2.29"	2.25"
NBT50-SF1250-6.30CP*	1.1/4"	6.30"	1.73"	2.09"	2.30"	2.25"

*Pricing on Request

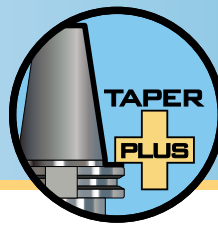

Shrinking Equipment



START.2 SHRINK FIT UNIT

- The world's easiest shrink machine to operate.
- Provided with accessories for shrinking $\varnothing 2$ to $\varnothing 40$ (.079" - 1.575").
- Compact and Ergonomic Design.
- 1 cooling unit included, multiple cooling units can be connected.
- Shrink machine unit net weight - 41.9 lbs. (19 kg)



STORAGE RACKS (INCLUDED)

COOLING UNIT



- Rapid Cooling - Tapered internal design allows for even distribution of high pressure air.
- Provided with accessories for cooling $\varnothing 2$ to $\varnothing 40$ (.079" - 1.575").
- Compressed air supply: 70 to 90 psi.
- Equipped with a filter and a pressure-reducing gauge to regulate the pressure and the air flow.
- Weight: 11 lbs. (5 kg)

FI-5B SHRINK FIT UNIT

- FI-5B - speed and safety in one
 - Speed - multiple cooling units to support high quantity tool assembly
 - Safety - Guide Rail prevents operator from handling hot tools
- The electronic board is cooled to allow high-speed shrinking.
- Provided with accessories for shrinking & cooling $\varnothing 2$ to $\varnothing 40$ (.079" - 1.575").
- Dimensions:
 - Length = 30.9" (785mm)
 - Depth = 19.29" (490mm)
 - Height = 33.66" (855mm)
- Weight (options excluded): 94.8 lbs. (43 kg)



PRESETTING UNIT (OPTIONAL)

- For length presetting
- For FI-5B shrink fit unit only
- Accuracy: $\pm 0,050\text{mm}$
- Repeatability: $\pm 0,020\text{mm}$
- Capability: tool shank $\varnothing 6$ to $\varnothing 32$ (.25" - 1.25")

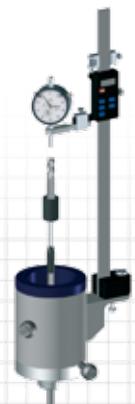

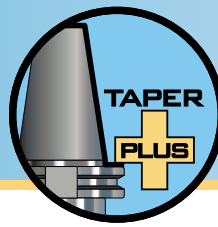

Shrink Fit Accessories



Start.2 Fi-5B

ACCESSORIES

Pot/Chuck Holder

	PART NUMBER	Start.2	Fi-5B
For HSK 25 chuck	SF-POT-HSK25	<input type="checkbox"/>	<input type="checkbox"/>
For HSK 32 chuck	SF-POT-HSK32	<input type="checkbox"/>	<input type="checkbox"/>
For HSK 40 chuck	SF-POT-HSK40	<input type="checkbox"/>	<input type="checkbox"/>
For HSK 50 chuck	SF-POT-HSK50	<input type="checkbox"/>	<input type="checkbox"/>
For HSK 63 chuck	SF-POT-HSK63	<input type="checkbox"/>	<input type="checkbox"/>
For HSK 80 chuck	SF-POT-HSK80	<input type="checkbox"/>	<input type="checkbox"/>
For HSK 100 chuck	SF-POT-HSK100	<input type="checkbox"/>	<input type="checkbox"/>
For BT 30 chuck	SF-POT-#30	<input type="checkbox"/>	<input type="checkbox"/>
For CAT / BT 40 chuck	SF-POT-#40	<input type="checkbox"/>	<input type="checkbox"/>
For BT 45 chuck	SF-POT-#45	<input type="checkbox"/>	<input type="checkbox"/>
For CAT / BT 50 chuck	SF-POT-#50	<input type="checkbox"/>	<input type="checkbox"/>



Start 2:
Choose any 2 Pots

Fi-5B:
Choose any 3 Pots

Heating Ring

Ø 2 to Ø 5 (5/64" - 3/16")	SF-HEAT-RING-2-5	■	■
Ø 6 to Ø 13 (1/4" - 1/2")	SF-HEAT-RING-6-13	■	■
Ø 14 to Ø 24 (9/16" - 7/8")	SF-HEAT-RING-14-24	■	■
Ø 25 to Ø 32 (1" - 1 1/4")	SF-HEAT-RING-25-32	■	■
Ø 33 to Ø 40 (1 1/4" - 1 1/2")	SF-HEAT-RING-33-40	■	■



Split Heating Ring

Ø 2 to Ø 5 (5/64" - 3/16")	SF-HEAT-RING-2-5(SP)	<input type="checkbox"/>	<input type="checkbox"/>
Ø 6 to Ø 13 (1/4" - 1/2")	SF-HEAT-RING-6-13(SP)	<input type="checkbox"/>	<input type="checkbox"/>
Ø 14 to Ø 24 (9/16" - 7/8")	SF-HEAT-RING-14-24(SP)	<input type="checkbox"/>	<input type="checkbox"/>
Ø 25 to Ø 32 (1" - 1 1/4")	SF-HEAT-RING-25-32(SP)	<input type="checkbox"/>	<input type="checkbox"/>
Ø 33 to Ø 40 (1 1/4" - 1 1/2")	SF-HEAT-RING-33-40(SP)	<input type="checkbox"/>	<input type="checkbox"/>



Additional Cooling Unit

Cooling unit for Fi-5B			■
------------------------	--	--	---



Cooling Brackets

Ø 2 to Ø 5 (5/64" - 3/16")	SF-COOL-BRACKET-2-6	■	■ x2
Ø 6 to Ø 13 (1/4" - 1/2")	SF-COOL-BRACKET-6-14	■	■ x2
Ø 14 to Ø 24 (9/16" - 7/8")	SF-COOL-BRACKET-14-25	■	■ x2
Ø 25 to Ø 32 (1" - 1 1/4")	SF-COOL-BRACKET-25-33	■	■ x2
Ø 33 to Ø 40 (1 1/4" - 1 1/2")	SF-COOL-BRACKET-33-41	■	■ x2



Shrinking with Reductions

Set up fixture Reduction Sleeve	SF-REDUCTION-FIXTURE	<input type="checkbox"/>	<input type="checkbox"/>
---------------------------------	----------------------	--------------------------	--------------------------



Various Accessories





Storage space for tools	SF-RACK-CUTTER		<input type="checkbox"/>
Storage space for chuck holders	SF-RACK-POT		<input type="checkbox"/>
Storage space for inductor & cooling stop rings	SF-RACK-HEAT-RING		<input type="checkbox"/>
Storage space for cooling stop rings	SF-RACK-COOL-STOP	<input type="checkbox"/>	
A pair of Kevlar gloves	SF-GLOVES	■	■
Plier for gripping small diameters	SF-PLIERS	<input type="checkbox"/>	<input type="checkbox"/>

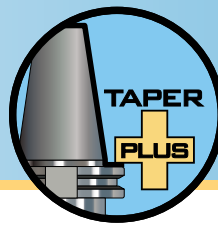



■ : Standard □ : Option



Shrink Fit Accessories

	PART NUMBER	Start.2	Fi-5B	
Shrink Fit Cabinet				
Stainless Steel Trolley	SF-CABINET	<input type="checkbox"/>		
Inductor				
Replacement Inductor	SF-INDUCTOR	<input type="checkbox"/>	<input type="checkbox"/>	
Electronic Board				
Motherboard 380 / 480V	SF-MOTHER-BOARD-380	<input type="checkbox"/>	<input type="checkbox"/>	
Motherboard 200 / 240V	SF-MOTHER-BOARD	<input type="checkbox"/>	<input type="checkbox"/>	
Remote Control				
Remote control	SF-CONTROL	<input type="checkbox"/>	<input type="checkbox"/>	

PRESETTING

	PART NUMBER	Start.2	Fi-5B	
Presetting Units				
Presetting unit by back-stop (Accessories : please contact us)	SF-PS-UNIT	<input type="checkbox"/>		
Presetting unit + 3 rods + ruler + indicator + one set of guides and guide holder	SF-PS-KIT		<input type="checkbox"/>	
Accessories for Presetting Units				
Set of tools guides Ø 1/4", 5/16", 3/8", 1/2", 5/8", 3/4"	SF-PS-TOOLGUIDE-KIT	<input checked="" type="checkbox"/>		
Presetting guides holder	SF-PS-GUIDE-HOLDER	<input checked="" type="checkbox"/>		
Presetting Clip Kit (19 sizes included in 1 kit)	SF-SPRING-CLIP-KIT	<input type="checkbox"/>		
Adapter for BT30 presetting	SF-PS-BT30-ADAPTER	<input type="checkbox"/>		
Adapter for CAT / BT40 presetting	SF-PS-CT/BT40-ADPTR	<input type="checkbox"/>		
Adapter for BT45 presetting	SF-PS-CT/BT45-ADPTR	<input type="checkbox"/>		
Adapter for CAT / BT50 presetting	SF-PS-CT/BT50-ADPTR	<input type="checkbox"/>		
Tool guide Ø 1/4"*	SF-PS-GUIDE-6M-0250	<input type="checkbox"/>		
Tool guide Ø 5/16"*	SF-PS-GUIDE-8M-0312	<input type="checkbox"/>		
Tool guide Ø 3/8"*	SF-PS-GUIDE-10M-0375	<input type="checkbox"/>		
Tool guide Ø 1/2"*	SF-PS-GUIDE-14M-0500	<input type="checkbox"/>		
Tool guide Ø 5/8"*	SF-PS-GUIDE-16M-0625	<input type="checkbox"/>		
Tool guide Ø 3/4"*	SF-PS-GUIDE-20M-0750	<input type="checkbox"/>		
Tool guide Ø 1"*	SF-PS-GUIDE-25M-1000	<input type="checkbox"/>		
Tool guide Ø 1 1/4"*	SF-PS-GUIDE-32M-1250	<input type="checkbox"/>		
Compact rod	SF-PS-COMPACT-ROD	<input type="checkbox"/>		
Standard & mold range rod	SF-PS-STD-ROD	<input type="checkbox"/>		
Ruler 300 mm	SF-PS-RULER	<input type="checkbox"/>		
Dial indicator	SF-PS-DIAL	<input type="checkbox"/>		

Spring Clip Kit -19 sizes in 1 kit:
MM - 3, 4, 5, 6, 8, 10, 12, 16, 20, 25
INCH- 1/8, 3/16, 1/4, 5/16, 3/8,
1/2, 5/8, 3/4, 1.0

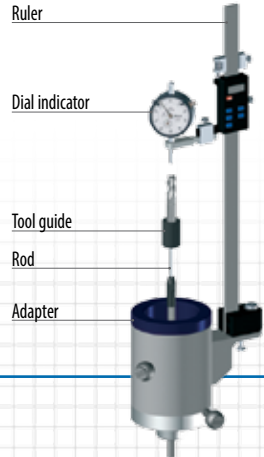

*Metric Available 6-32mm

■ : Standard □ : Option ■ : Replacement part



Lyndex-Nikken website:

Be sure to check out
our customer-friendly website

www.lyndexnikken.com

to find out more about our products,
services and all we have to offer!

This site provides a complete
overview of our product line, and
features technical data, videos,
CAD drawings, catalogs and more.

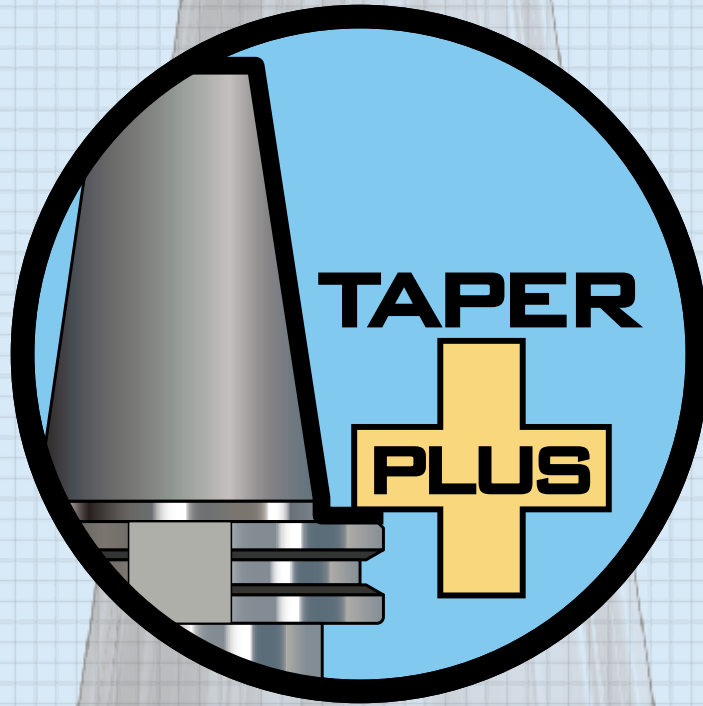

LYNDEX
NIKKEN



www.lyndexnikken.com

1468 Armour Boulevard

Mundelein, IL 60060

E-mail: sales@lyndexnikken.com

Phone: (847) 367-4800

Fax: (847) 367-4815

CAT2017-TAPERPLUS

JUNE 2017