

# Production Cutting Tools

Wood, Plastic, Composite, Honeycomb, Aluminum

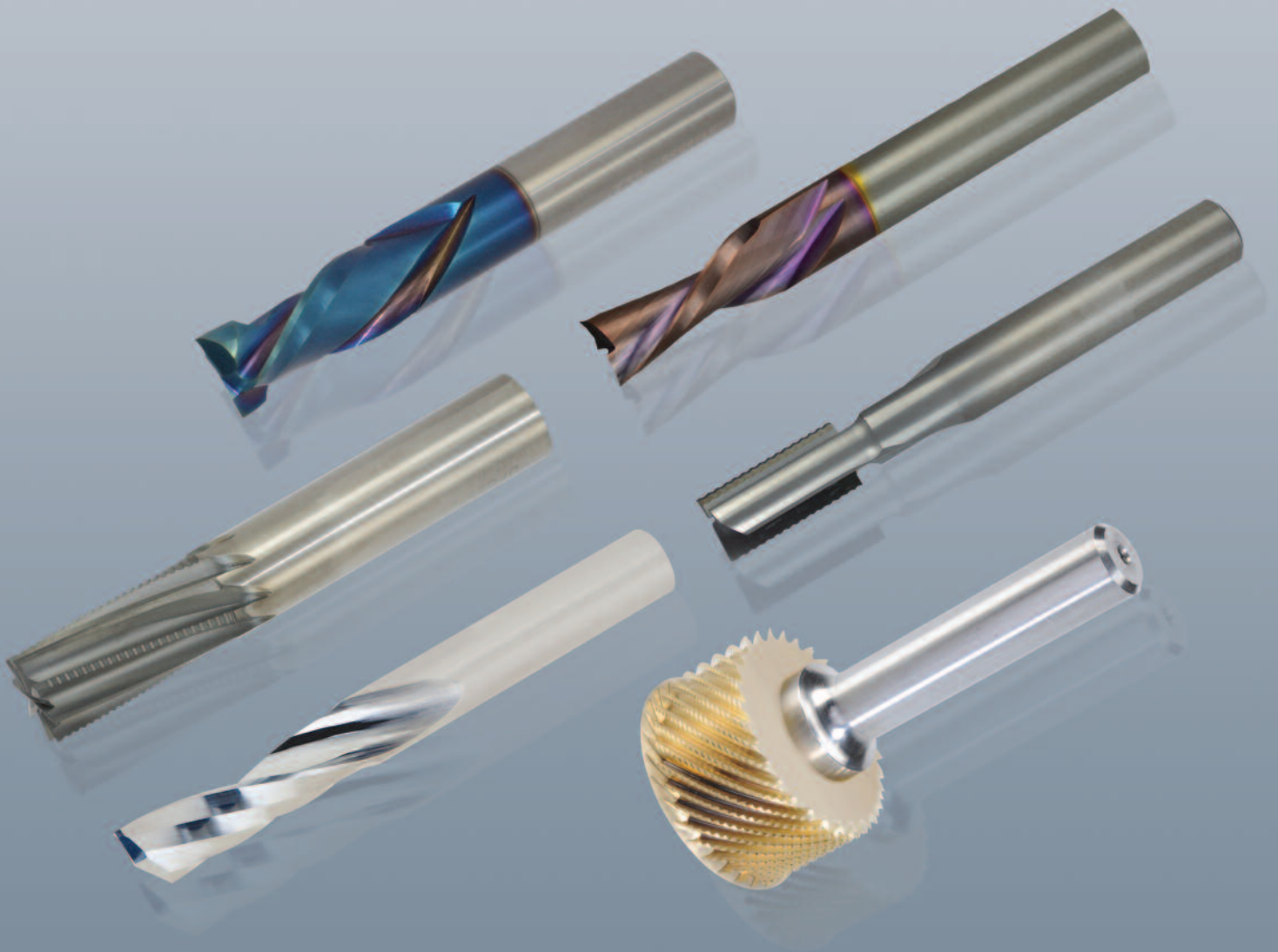

# TAKE IT ON

YOUR CHALLENGES, OUR EXPERTISE.



## comprehensive training

Increased productivity equals lower cost, improved profitability, and ultimately, survival of your business in today's competitive environment. **The LMT Onsrud Team** will work with all levels of your operation to increase your productivity. All levels of training, general to production-specific on the shop floor, are only a call away!

## factory technical support

LMT Onsrud provides your business with access to our staff of highly trained professional factory technicians. We can assist you with those difficult production machining problems while increasing your performance and productivity.

## on-site trouble shooting

Correct tool selection, proper hold-down techniques, faster feed rates, fewer and quicker set ups are all pieces to the productivity puzzle. **The LMT Onsrud Team** offers tailored solutions for problem solving and productivity gains.

























## custom tool design























Not only does LMT Onsrud offer the largest selections of cutting tools for day to day operations, but we will also design a tool for your specific application or material. We will take your tool requirements from the drawing board, to sophisticated computer-aided design, to in-house testing on our CNC router and CNC Mill. Custom tooling made to meet your productivity goals.

# Table of Contents

Cutting Tools	14-73	Resharpener Modifications	98
Accessories	74 - 79	Quote Request Form	99
Technical Information	80 - 97	Custom Tool Design	100

## Table of Contents by Material























<b>SW</b> <b>SOFT WOOD</b> Cedar, Cottonwood, Pine, Redwood	<b>PAGE</b>
 <b>10-00</b> HSS 1F O Flute Straight	15
 <b>28-50</b> CT 2F Flush Trim	18
 <b>29-50</b> CT 2F Straight Chamfer	18
 <b>37-00/37-20*</b> SC 1F 30° & 60° Engraving Tools	19
 <b>37-50/60</b> Carbide 2F V Bottom	19
 <b>37-80</b> CT 2F Lettering Bits	20
 <b>40-50</b> CT 2F Round & Rout	20
 <b>42-00</b> CT 2F Straight Corner Round	21
 <b>40-000</b> HSS 1F Upcut Spiral	28
 <b>40-000</b> HSS 1F Downcut Spiral	28
 <b>40-100</b> HSS 2F Upcut Spiral	29
 <b>40-100</b> HSS 2F Downcut Spiral	29
 <b>90-00</b> T Slot Cutter	21
 <b>52-200</b> SC 2F Spiral Upcut Wood Rout	31
 <b>52-200B/BL*</b> SC 2F Spiral Upcut Ball Nose	32
 <b>52-400*</b> SC 2F Spiral Upcut Wood Rout	32
 <b>52-700*</b> SC 2F Upcut "O" Flute	33
 <b>52-900</b> SC 2F Upcut Heavy Duty	34
 <b>56-200</b> SC 2F Straight Wood Rout	35
 <b>57-200</b> SC 2F Downcut Spiral Wood Rout	37
 <b>57-200MD</b> SC Marathon Wood Rout Downcut	37
 <b>57-400*</b> SC 2F Downcut Spiral Wood Rout	38
 <b>57-900</b> SC 2F Downcut Heavy Duty	38
 <b>60-000</b> SC 3F High Helix Chipbreaker	39

<b>SW</b> <b>SOFT WOOD</b> Cedar, Cottonwood, Pine, Redwood	<b>PAGE</b>
 <b>60-000</b> SC 3F Low Helix Chipbreaker	39
 <b>60-090*</b> SC 3F Upcut Lock Mortise	40
 <b>60-100MC*</b> SC Marathon Compression	40
 <b>60-100MW*</b> SC Compression Spiral	41
 <b>60-100C</b> SC 2F Chipbreaker/Finisher	42
 <b>60-100DC</b> SC Tuff Core Compression	42
 <b>60-100PLR NEW</b> Two Flute - Polaris Compression Spiral	41
 <b>60-200*</b> SC 3F Low Helix Finisher	43
 <b>60-300</b> SC 2F Chipbreaker Finisher	43
 <b>60-350</b> SC 3F Chipbreaker Finisher	44
 <b>60-600</b> SC 4F High Velocity Compression Spiral	44
 <b>60-700</b> SC 4F High Velocity Spiral	44
 <b>60-800</b> SC 2F Roughers	45
 <b>60-900</b> SC 3F Heavy Duty Hogger	45
 <b>60-950</b> SC 2F Heavy Duty Chipbreaker/Finisher	45
 <b>61-000</b> SC 1F "O" Flute Straight	46
 <b>61-200</b> SC 1F Straight Wood Rout	47
 <b>63-200</b> SC 1F Upcut Spiral Wood Rout	49
 <b>64-000*</b> SC 1F Downcut Super O	52
 <b>65-000*</b> SC 1F Upcut Super O	53
 <b>68-100</b> PCD 1F Compression	64
 <b>72-000*</b> SC Boring Bits	69
 <b>77-100*</b> SC 2F & 3F Taper Tools	70







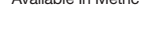















\* Available In Metric

\* Available In Metric

# Table of Contents by Material











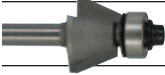



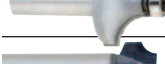
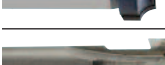





<b>HW</b>	<b>HARD WOOD</b> Ash, Beech, Birch, Cherry, Mahogany, Maple, Oak, Poplar, Teak, Walnut	<b>PAGE</b>
	<b>28-50</b> CT 2F Flush Trim	18
	<b>29-50</b> CT 2F Straight Chamfer	18
	<b>37-00/37-20*</b> SC 1F 30° & 60° Engraving Tools	19
	<b>37-50/60</b> Carbide 2F V Bottom	19
	<b>37-80</b> CT 2F Lettering Bits	20
	<b>40-50</b> CT 2F Round & Rout	20
	<b>42-00</b> CT 2F Straight Corner Round	21
	<b>90-00</b> T Slot Cutter	21
	<b>40-000</b> HSS 1F Upcut Spiral	28
	<b>40-000</b> HSS 1F Downcut Spiral	28
	<b>40-100</b> HSS 2F Upcut Spiral	29
	<b>40-100</b> HSS 2F Downcut Spiral	29
	<b>48-000</b> CT 1F & 2F Straight	30
	<b>52-200</b> SC 2F Spiral Upcut Wood Rout	31
	<b>52-200B/BL*</b> SC 2F Spiral Upcut Ball Nose	32
	<b>52-400*</b> SC 2F Spiral Upcut Wood Rout	32
	<b>52-700*</b> SC 2F Upcut "O" Flute	33
	<b>52-900</b> SC 2F Upcut Heavy Duty	34
	<b>56-200</b> SC 2F Straight Wood Rout	35
	<b>57-200</b> SC 2F Downcut Spiral Wood Rout	37
	<b>57-200MD</b> SC Marathon Wood Rout Downcut	37
	<b>57-400*</b> SC 2F Downcut Spiral Wood Rout	38
	<b>57-900</b> SC 2F Downcut Heavy Duty	38
	<b>60-000</b> SC 3F High Helix Chipbreaker	39

\* Available In Metric















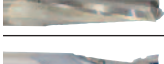



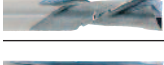

<b>HW</b>	<b>HARD WOOD</b> Ash, Beech, Birch, Cherry, Mahogany, Maple, Oak, Poplar, Teak, Walnut	<b>PAGE</b>
	<b>60-000</b> SC 3F Low Helix Chipbreaker	39
	<b>60-090*</b> SC 3F Upcut Lock Mortise	40
	<b>60-100DC</b> SC Tuff Core Compression	42
	<b>60-100MC*</b> SC Marathon Compression	40
	<b>60-100MW*</b> SC Compression Spiral	41
	<b>60-100PLR NEW</b> Two Flute - Polaris Compression Spiral	41
	<b>60-100C</b> SC 2F Chipbreaker/Finisher	42
	<b>60-200*</b> SC 3F Low Helix Finisher	43
	<b>60-300</b> SC 2F Chipbreaker Finisher	43
	<b>60-350</b> SC 3F Chipbreaker Finisher	44
	<b>60-600</b> SC 4F High Velocity Compression Spiral	44
	<b>60-700</b> SC 4F High Velocity Spiral	44
	<b>60-800</b> SC 2F Roughers	45
	<b>60-900</b> SC 3F Heavy Duty Hogger	45
	<b>60-950</b> SC 2F Heavy Duty Chipbreaker/Finisher	45
	<b>61-200</b> SC 1F Straight Wood Rout	47
	<b>63-200</b> SC 1F Upcut Spiral Wood Rout	49
	<b>64-000*</b> SC 1F Downcut Super O	52
	<b>65-000*</b> SC 1F Upcut Super O	53
	<b>68-100</b> PCD 1F Compression	64
	<b>72-000*</b> SC Boring Bits	69
	<b>77-100*</b> SC 2F & 3F Taper Tools	70

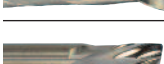
\* Available In Metric

# Table of Contents by Material

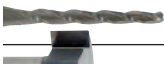











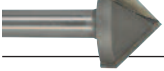

<b>CW</b> <i>MDF</i>		<i>PAGE</i>
	<b>28-50</b> CT 2F Flush Trim	18
	<b>29-50</b> CT 2F Straight Chamfer	18
	<b>37-50/60</b> Carbide 2F V Bottom	19
	<b>37-80</b> CT 2F Lettering Bits	20
	<b>40-50</b> CT 2F Round & Rout	20
	<b>42-00</b> CT 2F Straight Corner Round	21
	<b>47-00</b> CT 2F MDF Panel Tools	21
	<b>90-00</b> T Slot Cutter	21
	<b>48-000</b> CT 1F & 2F Straight	30
	<b>52-200</b> SC 2F Spiral Upcut Wood Rout	31
	<b>52-200B/BL*</b> SC 2F Spiral Upcut Ball Nose	32
	<b>52-400*</b> SC 2F Spiral Upcut Wood Rout	32
	<b>52-900</b> SC 2F Upcut Heavy Duty	34
	<b>56-200</b> SC 2F Straight Wood Rout	35
	<b>57-200</b> SC 2F Downcut Spiral Wood Rout	37
	<b>57-200MD</b> SC Marathon Wood Rout Downcut	37
	<b>57-400*</b> SC 2F Downcut Spiral Wood Rout	38
	<b>57-900</b> SC 2F Downcut Heavy Duty	38
	<b>60-000</b> SC 3F High Helix Chipbreaker	39
	<b>60-000</b> SC 3F Low Helix Chipbreaker	39
	<b>60-090*</b> SC 3F Upcut Lock Mortise	40
	<b>60-100MC*</b> SC Marathon Compression	40

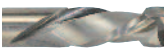
\* Available In Metric













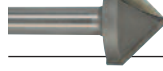

<b>CW</b> <i>MDF</i>		<i>PAGE</i>
	<b>60-100MW*</b> SC Max Life Compression Spiral	41
	<b>60-100C</b> SC 2F Chipbreaker/Finisher	42
	<b>60-100DC</b> SC Tuff Core Compression	42
	<b>60-100PLR NEW</b> Two Flute - Polaris Compression Spiral	41
	<b>60-200*</b> SC 3F Low Helix Finisher	43
	<b>60-300</b> SC 2F Chipbreaker Finisher	43
	<b>60-350</b> SC 3F Chipbreaker Finisher	44
	<b>60-600</b> SC 4F High Velocity Compression Spiral	44
	<b>60-700</b> SC 4F High Velocity Spiral	44
	<b>60-800</b> SC 2F Roughers	45
	<b>60-900</b> SC 3F Heavy Duty Hogger	45
	<b>60-950</b> SC 2F Heavy Duty Chipbreaker/Finisher	45
	<b>61-200</b> SC 1F Straight Wood Rout	47
	<b>63-200</b> SC 1F Upcut Spiral Wood Rout	49
	<b>64-000*</b> SC 1F Downcut Super O	52
	<b>65-000*</b> SC 1F Upcut Super O	53
	<b>68-100</b> PCD 1F Compression	64
	<b>72-000*</b> SC Boring Bits	69
	<b>77-100*</b> SC 2F & 3F Taper Tools	70
	<b>91-000</b> CT Spoilboard Cutter	73
	<b>91-100</b> Insert Spoilboard Cutter	73

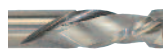
\* Available In Metric

# Table of Contents by Material

<b>LW</b>	<b>LAMINATED CHIPBOARD</b>	<b>PAGE</b>
	<b>27-00</b> SC 1F Laminate Trim	17
	<b>27-50</b> SC 2F Straight Laminate Trim	17
	<b>28-50</b> CT 2F Flush Trim	18
	<b>37-80</b> CT 2F Lettering Bits	20
	<b>48-000</b> CT 1F & 2F Straight	30
	<b>57-200</b> SC 2F Downcut Spiral Wood Rout	37
	<b>57-200MD</b> SC Marathon Wood Rout Downcut	37
	<b>60-100MW*</b> SC Max Life Compression Spiral	41
	<b>60-100C</b> SC 1F Chipbreaker/Finisher	42
	<b>60-100DC</b> SC Tuff Core Compression	42
	<b>60-100MC*</b> SC Marathon Compression	40
	<b>60-100PLR</b> Two Flute - Polaris Compression Spiral	41
	<b>60-600</b> SC 4F High Velocity Compression Spiral	44
	<b>68-100</b> PCD 1F Compression	64
	<b>72-000*</b> SC Boring Bits	69

\* Available In Metric















<b>LW</b>	<b>LAMINATED PLYWOOD</b>	<b>PAGE</b>
	<b>27-00</b> SC 1F Laminate Trim	17
	<b>27-50</b> SC 2F Straight Laminate Trim	17
	<b>28-50</b> CT 2F Flush Trim	18
	<b>37-80</b> CT 2F Lettering Bits	20
	<b>48-000</b> CT 1F & 2F Straight	30
	<b>57-200</b> SC 2F Downcut Spiral Wood Rout	37
	<b>57-200MD</b> SC Marathon Wood Rout Downcut	37
	<b>60-100MW*</b> SC Compression Spiral	41
	<b>60-100MC</b> SC Marathon Compression	40
	<b>60-100C</b> SC 2F Chipbreaker/Finisher	42
	<b>60-100DC</b> SC Tuff Core Compression	42
	<b>60-100PLR NEW</b> Two Flute - Polaris Compression Spiral	41
	<b>60-600</b> SC 4F High Velocity Compression Spiral	44
	<b>68-100</b> PCD 1F Compression	64
	<b>72-000*</b> SC Boring Bits	69

\* Available In Metric

# Table of Contents by Material

















<b>CW</b>	<b>SOFT PLYWOOD</b>	<b>PAGE</b>
	<b>37-50/60</b> SC 2F V Bottom	19
	<b>37-80</b> CT 2F Lettering Bits	20
	<b>40-50</b> CT 2F Round & Rout	20
	<b>48-000</b> CT 1F & 2F Straight	30
	<b>52-200</b> SC 2F Spiral Upcut Wood Rout	31
	<b>52-200B/BL*</b> SC 2F Spiral Upcut Ball Nose	32
	<b>56-200</b> SC 2F Straight Wood Rout	35
	<b>57-200</b> SC 2F Downcut Spiral Wood Rout	37
	<b>57-200MD</b> SC Marathon Wood Rout Downcut	37
	<b>60-000</b> SC 3F High Helix Chipbreaker	39
	<b>60-000</b> SC 3F Low Helix Chipbreaker	39
	<b>60-090*</b> SC 3F Upcut Lock Mortise	40
	<b>60-100MC*</b> SC Marathon Compression	40
	<b>60-100MW*</b> SC Compression Spiral	41
	<b>60-100PLR NEW</b> Two Flute - Polaris Compression Spiral	41
	<b>60-100C</b> SC 2F Chipbreaker/Finisher	42

\* Available In Metric















<b>CW</b>	<b>SOFT PLYWOOD</b>	<b>PAGE</b>
	<b>60-100DC</b> SC Tuff Core Compression	42
	<b>60-300</b> SC 2F Chipbreaker Finisher	43
	<b>60-350</b> SC 3F Chipbreaker Finisher	44
	<b>60-600</b> SC 4F High Velocity Compression Spiral	44
	<b>60-700</b> SC 4F High Velocity Spiral	44
	<b>60-800</b> SC 2F Roughers	45
	<b>60-900</b> SC 3F Heavy Duty Hogger	45
	<b>60-950</b> SC 2F Heavy Duty Chipbreaker/Finisher	45
	<b>61-200</b> SC 1F Straight Wood Rout	47
	<b>63-200</b> SC 1F Upcut Spiral Wood Rout	49
	<b>64-000*</b> SC 1F Downcut Super O	52
	<b>65-000*</b> SC 1F Upcut Super O	53
	<b>68-100</b> PCD 1F Compression	64
	<b>72-000*</b> SC Boring Bits	69
	<b>77-100*</b> SC 2F & 3F Taper Tools	70

\* Available In Metric

# Table of Contents by Material

<b>CW</b>	<b>HARD PLYWOOD</b>	<b>PAGE</b>
	<b>37-50/60</b> Carbide 2F V Bottom	19
	<b>37-80</b> CT 2F Lettering Bits	20
	<b>40-50</b> CT 2F Round & Rout	20
	<b>48-000</b> CT 1F & 2F Straight	30
	<b>52-200</b> SC 2F Spiral Upcut Wood Rout	31
	<b>56-200</b> SC 2F Straight Wood Rout	35
	<b>57-200</b> SC 2F Downcut Spiral Wood Rout	37
	<b>57-200MD</b> SC Marathon Wood Rout Downcut	37
	<b>60-000</b> SC 3F High Helix Chipbreaker	39
	<b>60-000</b> SC 3F Low Helix Chipbreaker	39
	<b>60-090*</b> SC 3F Upcut Lock Mortise	40
	<b>60-100MC*</b> SC Marathon Compression	40
	<b>60-100MW*</b> SC Compression Spiral	41
	<b>60-100PLR NEW</b> Two Flute - Polaris Compression Spiral	41
	<b>60-100C</b> SC 2F Chipbreaker/Finisher	42
	<b>60-100DC</b> SC Tuff Core Compression	42

\* Available In Metric

<b>CW</b>	<b>HARD PLYWOOD</b>	<b>PAGE</b>
	<b>60-300</b> SC 2F Chipbreaker Finisher	43
	<b>60-350</b> SC 3F Chipbreaker Finisher	44
	<b>60-600</b> SC 4F High Velocity Compression Spiral	44
	<b>60-700</b> SC 4F High Velocity Spiral	44
	<b>60-800</b> SC 2F Roughers	45
	<b>60-900</b> SC 3F Heavy Duty Hogger	45
	<b>60-950</b> SC 2F Heavy Duty Chipbreaker/Finisher	45
	<b>61-200</b> SC 1F Straight Wood Rout	47
	<b>63-200</b> SC 1F Upcut Spiral Wood Rout	49
	<b>64-000*</b> SC 1F Downcut Super O	52
	<b>65-000*</b> SC 1F Upcut Super O	53
	<b>68-100</b> PCD 1F Compression	64
	<b>72-000*</b> SC Boring Bits	69
	<b>77-100*</b> SC 2F & 3F Taper Tools	70

\* Available In Metric























# Table of Contents by Material



## SOFT PLASTIC

ABS, Polycarbonate, Polyethylene, PVC,  
Polypropylene, HDPE, Polystyrene, UHMW,  
Extruded Acrylic



















		PAGE
	<b>10-00</b> HSS 1F O Flute Straight	15
	<b>11-00</b> HSS 1F or 2F O Flute Straight	15
	<b>28-20</b> SC Double Bearing Plastic Trim	18
	<b>28-50</b> CT 2F Flush Trim	18
	<b>37-00/37-20*</b> SC 1F 30° & 60° Engraving Tools	19
	<b>37-50/60</b> Carbide 2F V Bottom	19
	<b>40-50</b> CT 2F Round & Rout	20
	<b>52-200</b> SC 2F Spiral Upcut Wood Rout	31
	<b>52-200B/BL*</b> SC 2F Ball Nose	32
	<b>52-400*</b> SC 2F Spiral Upcut Wood Rout	32
	<b>52-600</b> SC 2F Upcut "O" Flute	33
	<b>52-700*</b> SC 2F Upcut "O" Flute	33
	<b>56-430*</b> SC 2F Straight O Flute	36
	<b>56-600</b> SC 2F Straight "O" Flute	36
	<b>57-600*</b> SC 2F Downcut "O" Flute	38
	<b>60-000</b> SC 3F High Helix Chipbreaker	39
	<b>60-000</b> SC 3F Low Helix Chipbreaker	39
	<b>60-900</b> SC 3F Heavy Duty Hogger	45
	<b>61-000P</b> SC 1F "O" Flute Straight	46
	<b>61-400*</b> SC 1F Straight	47

\* Available In Metric























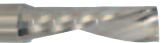



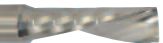





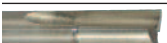



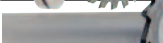

## SOFT PLASTIC

ABS, Polycarbonat, Polyethylene, PVC,  
Polypropylene, HDPE, Polystyrene, UHMW,  
Extruded Acrylic

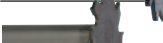
		PAGE
	<b>62-750</b> SC 1F Downcut "O" Flute	48
	<b>62-850*</b> SC 1F Downcut "O" Flute	48
	<b>63-500</b> SC 1F Upcut "O" Flute	50
	<b>63-750</b> SC 1F Upcut "O" Flute	51
	<b>63-850*</b> SC 1F Upcut "O" Flute	51
	<b>64-000*</b> SC 1F Downcut Super O	52
	<b>65-000*</b> SC 1F Upcut Super O	53
	<b>65-200B*</b> SC 2F High Finish Ballnose for Plastics	53
	<b>65-300B</b> SC 4F High Finish Ballnose for Plastics	53
	<b>66-000</b> SC Edge Rounding Bits	54
	<b>66-200</b> SC 2F Rout and Chamfer	55
	<b>66-300</b> SC 2F Upcut Bottom Surfacing	55
	<b>67-800*</b> SC 8 Facet Drill	63
	<b>70-100</b> CT Blade and Arbor	66
	<b>70-200</b> SC Flush Mount Blade	67
	<b>70-300</b> CT Flush Mount Blade	67
	<b>70-500*</b> HSS Plastic Drills	68
	<b>77-100*</b> SC 2F & 3F Taper Tools	70
	<b>91-100</b> Insert Spoilboard Cutter	73

\* Available In Metric























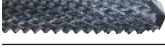

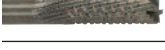

# Table of Contents by Material

<b>HP</b> <b>HARD PLASTIC</b> Cast Acrylic, Melamine, Nylon, PVC, Vinyl	<b>PAGE</b>	<b>HP</b> <b>HARD PLASTIC</b> Cast Acrylic, Melamine, Nylon, PVC, Vinyl	<b>PAGE</b>
 <b>11-00</b> HSS 1F or 2F O Flute Straight	15	 <b>62-750</b> SC 1F Downcut "O" Flute	48
 <b>28-20</b> SC Double Bearing Plastic Trim	18	 <b>62-800*</b> SC 1F Downcut "O" Flute	48
 <b>37-00/37-20*</b> SC 1F 30° & 60° Engraving Tools	19	 <b>62-850*</b> SC 1F Downcut "O" Flute	48
 <b>37-50/60</b> Carbide 2F V Bottom	10	 <b>63-500</b> SC 1F Upcut "O" Flute	50
 <b>40-50</b> CT 2F Round & Rout	20	 <b>63-700</b> SC 1F Upcut "O" Flute	51
 <b>52-200B/BL*</b> SC 2F Ball Nose	32	 <b>63-750</b> SC 1F Upcut "O" Flute	51
 <b>52-600</b> SC 2F Upcut "O" Flute	33	 <b>63-800*</b> SC 1F Upcut "O" Flute	51
 <b>56-000</b> SC 2F Straight	35	 <b>63-850*</b> SC 1F Upcut "O" Flute	51
 <b>56-000P</b> SC 2F Straight	35	 <b>64-000*</b> SC 1F Downcut Super O	52
 <b>56-430*</b> SC 2F Straight O Flute	36	 <b>65-000*</b> SC 1F Upcut Super O	53
 <b>56-450*</b> SC 2F Straight	36	 <b>66-000</b> SC Edge Rounding Bits	54
 <b>56-600</b> SC 2F Straight "O" Flute	36	 <b>66-200</b> SC 2F Rout and Chamfer	55
 <b>57-600*</b> SC 2F Downcut "O" Flute	38	 <b>66-300</b> SC 2F Upcut Bottom Surfacing	55
 <b>60-000</b> SC 3F High Helix Chipbreaker	39	 <b>67-800*</b> SC 8 Facet Drill	63
 <b>60-000</b> SC 3F Low Helix Chipbreaker	39	 <b>70-100</b> CT Blade and Arbor	66
 <b>60-200*</b> SC 3F Low Helix Finisher	43	 <b>70-200</b> SC Flush Mount Blade	67
 <b>60-900</b> SC 3F Heavy Duty Hogger	45	 <b>70-300</b> CT Flush Mount Blade	67
 <b>61-000P</b> SC 1F "O" Flute Straight	46	 <b>70-500*</b> HSS Plastic Drills	68
 <b>61-400*</b> SC 1F Straight	47	 <b>77-100*</b> SC 2F & 3F Taper Tools	70
 <b>62-700</b> SC 1F Downcut "O" Flute	48	 <b>91-100</b> Insert Spoilboard Cutter	73

\* Available In Metric

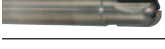
\* Available In Metric







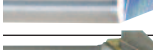

# Table of Contents by Material

<b>CP</b>	<b>COMPOSITE</b>	Carbon Fiber, Fiberglass, Phenolic, Reinforced Acetal	<b>PAGE</b>
	<b>52-000</b>	SC 2F Spiral Upcut	31
	<b>53-000</b>	SC 3F Straight	34
	<b>54-200*</b>	SC 3F & 4F Spiral for Glass Reinforced Plastic	34
	<b>56-000</b>	SC 2F Straight	35
	<b>56-000P</b>	SC 2F Straight	35
	<b>56-450*</b>	SC 2F Straight	36
	<b>57-000</b>	SC 2F Downcut Spiral	37
	<b>63-000</b>	SC 1F Upcut Spiral	48
	<b>66-500* NEW</b>	DFC Multi Flute Composite Router	56
	<b>66-700* NEW</b>	DFC Low Helix Finisher - Upcut	57
	<b>66-750* NEW</b>	DFC Low Helix Cutter - Upcut	57
	<b>66-775* NEW</b>	DFC Low Helix Rougher Finisher - Upcut	58
	<b>66-800* NEW</b>	DFC Compression	58
	<b>66-900*</b>	SC High Performance Composite Router	59
	<b>67-000*</b>	SC Fiberglass Burr Bits	60
	<b>67-200*</b>	SC 3F Phenolic Cutter	61
	<b>67-220*</b>	PCD 3F Progressive Chipbreaker	61
	<b>67-250</b>	3F Diamond Grit Tools	60
	<b>67-400*</b>	SC Un-Ruffer	62
	<b>67-500*</b>	SC Carbon Graphite Tool	62
	<b>67-800*</b>	SC 8 Facet Drill	63
	<b>68-000</b>	2F PCD Tipped Tools	64
	<b>68-200*</b>	PCD 2F SERF Cutter	65
	<b>68-300*</b>	PCD 3F SERFIN™ Cutter	65
	<b>68-400* NEW</b>	PCD 2F Ballnose	65
	<b>68-900</b>	PCD 8 Facet Drills	66
	<b>85-800* NEW</b>	SC CFRP Drills	72
	<b>86-150 NEW</b>	DFC Aerospace Composite Drill (ACD)	73

\* Available In Metric



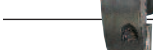





	<b>HONEYCOMB</b>	<b>PAGE</b>
	<b>29-000</b> HSS Hollow Core Cutters	22
	<b>29-050*</b> Diamond Grit Hogger	22
	<b>29-100/29-100B*</b> SC Honeycomb Hogger	23
	<b>30-000*</b> Replaceable Ring Type Honeycomb Cutter	23
	<b>30-300 HSS</b> Integral Shank Honeycomb Hogger Cutter	24
	<b>30-700</b> Reduced Weight Honeycomb Cutter	24
	<b>31-000</b> HSS Cutter	25
	<b>31-100</b> HSS Honeycomb Cutter with Teeth	25
	<b>32-200 NEW</b> HSS 3 Piece Honeycomb Hogger	26
	<b>34-000</b> Aircraft Panel Tools	26
	<b>34-100* NEW</b> Potted Fastener Tool	27
	<b>66-400 NEW</b> SC Honeycomb Compression	28

\* Available In Metric



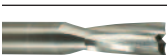







	<b>SPECIAL PURPOSE</b>	<b>PAGE</b>
	<b>37-00*</b> SC 1F 60° Engraving Tools	19
	<b>37-20*</b> SC 1F 30° Engraving Tools	19
	<b>37-70</b> CT 2F Dibond/Alucobond Folding Tool	20
	<b>70-100</b> CT Blade and Arbor	66
	<b>70-200</b> SC Flush Mount Blade	67
	<b>70-300</b> CT Flush Mount Blade	67
	<b>83-300</b> SC 2F Upcut for Stainless Steel Cutter	71
	<b>91-000</b> CT Spoilboard Cutter	73
	<b>91-100</b> Insert Spoilboard Cutter	73

\* Available In Metric

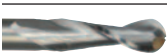











# Table of Contents by Material

<b>SSP</b>	<b>SOLID SURFACE</b>	<b>PAGE</b>
	<b>37-00/37-20*</b> SC 1F 30° & 60° Engraving Tools	19
	<b>37-50/60</b> Carbide 2F V Bottom	19
	<b>40-50</b> CT 2F Round & Rout	20
	<b>42-00</b> CT 2F Straight Corner Round	21
	<b>52-000</b> SC 2F Spiral Upcut	31
	<b>52-200B/BL*</b> SC 2F Ball Nose	32
	<b>52-400*</b> SC 2F Spiral Upcut Wood Rout	32
	<b>52-600</b> SC 2F Upcut "O" Flute	33
	<b>52-700*</b> SC 2F Upcut "O" Flute	33
	<b>56-000P</b> SC 2F Straight	35
	<b>56-450*</b> SC 2F Straight	36
	<b>57-600</b> SC 2F Downcut "O" Flute	38











\* Available In Metric

<b>A</b>	<b>ALUMINUM</b>	<b>PAGE</b>
	<b>37-00/37-20*</b> SC 1F 30° & 60° Engraving Tools	19
	<b>40-000</b> HSS 1F Upcut & Downcut Spiral	28
	<b>40-100</b> HSS 2F Upcut & Downcut Spiral	29
	<b>49-000</b> HSS 2F Steel Downcut	31
	<b>52-000</b> SC 2F Spiral Upcut	31
	<b>52-200B/BL*</b> SC 2F Ball Nose	32
	<b>57-000</b> SC 2F Downcut Spiral	37
	<b>61-000</b> SC 1F "O" Flute Straight	46
	<b>62-600</b> SC 1F "O" Flute Downcut Spiral	47
	<b>63-000</b> SC 1F Upcut Spiral	48
	<b>63-400*</b> SC 1F Upcut for Soft Aluminum	49

\* Available In Metric



<b>SSP</b>	<b>SOLID SURFACE</b>	<b>PAGE</b>
	<b>60-200*</b> SC 3F Low Helix Finisher	43
	<b>62-700</b> SC 1F Downcut "O" Flute	48
	<b>62-750</b> SC 1F Downcut "O" Flute	48
	<b>62-800*</b> SC 1F Downcut "O" Flute	48
	<b>62-850*</b> SC 1F Downcut "O" Flute	48
	<b>63-700</b> SC 1F Upcut "O" Flute	51
	<b>63-750</b> SC 1F Upcut "O" Flute	51
	<b>63-800*</b> SC 1F Upcut "O" Flute	51
	<b>63-850*</b> SC 1F Upcut "O" Flute	51
	<b>64-000*</b> SC 1F Downcut Super O	52
	<b>65-000*</b> SC 1F Upcut Super O	53
	<b>66-000</b> SC Edge Rounding Bits	54

\* Available In Metric



<b>A</b>	<b>ALUMINUM</b>	<b>PAGE</b>
	<b>63-600</b> SC 1F "O" Flute Upcut Spiral	50
	<b>63-900*</b> SC 1F "O" Flute Upcut Spiral	52
	<b>64-000*</b> SC 1F Downcut Super O	52
	<b>65-000*</b> SC 1F Upcut Super O	53
	<b>66-300</b> SC 2F Upcut Bottom Surfacing	55
	<b>77-100*</b> SC 2F & 3F Taper Tools	70
	<b>80-000</b> HSS 3F Taper Pin Router	70
	<b>81-000</b> HSS 2F Lo Helix	71
	<b>81-100</b> SC 2F Extrusion Cutter	71
	<b>91-100</b> Insert Spoilboard Cutter	73

\* Available In Metric





# Table of Contents by Material

<b>CM DW</b>	<b>CONSTRUCTION MATERIAL</b> Drywall, RV/Mobile and Modular Housing	<b>PAGE</b>
	<b>18-00</b> HSS 1F Straight Pilot Bit	16
	<b>20-00</b> HSS 1F Downcut Spiral Pilot Bit	17



\* Available In Metric

<b>FP</b>	<b>FOAM</b>	<b>PAGE</b>
	<b>40-550</b> HSS 4F Foam Cutters	29
	<b>48-000</b> CT 1F & 2F Straight	30
	<b>52-550</b> SC 2F Foam Cutters	32

\* Available In Metric

<b>MT</b>	<b>MORTISING</b>	<b>PAGE</b>
	<b>60-090</b> SC 3F Upcut Lock Mortise	40
	<b>60-100C</b> SC 2F Chipbreaker/Finisher	42
	<b>60-100DC</b> SC Tuff Core Compression	42
	<b>60-100MC*</b> SC Marathon Compression	40

\* Available In Metric



<b>D</b>	<b>METAL DOORS</b>	<b>PAGE</b>
	<b>15-50</b> HSS 1F Dor Bit	16
	<b>15-75</b> HSS 3F Dor Bit	16

\* Available In Metric



	<b>ACCESSORIES</b>	<b>PAGE</b>
	<b>33-00</b> Fiver Adapter Bushing	75
	<b>33-10</b> Collet Brush Kit	75
	<b>33-21</b> Cleaning Solvent & Rust Protector	75
	<b>33-30</b> Tool Extender	75
	<b>33-60</b> Spindle Taper Wiper	76
	<b>33-90</b> HSK 63F Toolholders for CNC Routers	76

<b>CM DW</b>	<b>CONSTRUCTION MATERIAL</b> Drywall, RV/Mobile and Modular Housing	<b>PAGE</b>
	<b>20-10</b> HSS 1F Drywall Bit	17

\* Available In Metric

<b>FP</b>	<b>FOAM</b>	<b>PAGE</b>
	<b>52-700*</b> SC 2F Upcut "O" Flute	33
	<b>56-000P</b> SC 2F Straight	35
	<b>77-100</b> SC 2F & 3F Taper Tools	64





\* Available In Metric

<b>MT</b>	<b>MORTISING</b>	<b>PAGE</b>
	<b>60-100MW*</b> SC Max Life Compression Spiral	41
	<b>60-100PLR NEW</b> Two Flute - Polaris Compression Spiral	41
	<b>68-100</b> PCD 1F Compression	64

\* Available In Metric

<b>M</b>	<b>METAL</b>	<b>PAGE</b>
	<b>83-300</b> SC 2F Stainless Steel Cutter	71

\* Available In Metric

	<b>ACCESSORIES</b>	<b>PAGE</b>
	<b>Collets</b> ER Precision Inch	77
	<b>33-50</b> Collet Life Plug	77
	<b>Collets</b> ER 20, 25, 32, 40 Precision Metric	78
	<b>34-550</b> Perske (SYOZ)/DIN6388 Collets & Nuts	79
	<b>34-700</b> Ultra High-Speed ER Coated Nuts	79

# TABLE OF CONTENTS

10-00	HSS 1F O Flute Straight	15	48-000	CT 2F Straight	30	63-400*	SC 1F Upcut for Soft Aluminum	49
11-00	HSS O Flute Straight	15	49-000	HSS 2F Steel Downcut	31	63-500	SC 1F Acrylic Tools	50
15-50	HSS 1F Steel Dor Bit	16	52-000	SC 2F Spiral Upcut	31	63-600	SC 1F "O" Flute Upcut Spiral	50
15-75	HSS 3F CNC Dor Bit	16	52-200	SC 2F Spiral Upcut Wood Rout	31	63-700	SC 1F Upcut "O" Flute	51
18-00	HSS 1F Straight Pilot	16	52-200B/BL*	SC 2F Ball Nose	32	63-750	SC 1F Upcut "O" Flute	51
20-00	HSS 1F Downcut Spiral Pilot	17	52-400*	SC 2F Spiral Upcut Wood Rout	32	63-800*	SC 1F Upcut "O" Flute	51
20-10	HSS 1F Drywall Bit	17	52-550	SC 2F Foam Cutters	32	63-850*	SC 1F Upcut "O" Flute	51
27-00	SC 1F Laminate Trim	17	52-600	SC 2F Upcut "O" Flute	33	63-900*	SC 1F "O" Flute Upcut Spiral	52
27-50	SC 2F Laminate Trim	17	52-700*	SC 2F Upcut "O" Flute	33	64-000*	SC 1F Downcut Super O	52
28-20	SC Double-Bearing Plastic Trim	18	52-900	SC 2F Upcut Heavy Duty	34	65-000*	SC 1F Upcut Super O	53
28-50	CT Flush Trim	18	53-000	SC 3F Straight	34	65-200B*	SC 2F High Finish Ballnose	53
29-50	CT Chamfer	18	54-200	SC 3F & 4F Spiral for Glass Reinforced Plastic	34	65-300B*	SC 4F High Finish Ballnose	53
33-00	Fiver Adapter Bushing	75	56-000	SC 2F Straight	35	66-000	SC Edge Rounding Bits	54
33-10	Collet Brush Kit	75	56-000P	SC 2F Straight	35	66-200	SC 2F Rout and Chamfer	55
33-21	Cleaning Solvent & Rust Protector	75	56-200	SC 2F Straight Wood Rout	35	66-300	SC 2F Upcut Bottom Surfacing	55
33-30	Tool Extender	75	56-430*	SC 2F Straight O Flute	36	66-400	SC Honeycomb Compression	28
33-60	Spindle Taper Wiper	76	56-450*	SC 2F Straight	36	66-500*	DFC Multi Flute Composite Router	56
33-90	HSK 63F Toolholders for CNC Routers	76	56-600	SC 2F Straight "O" Flute	36	66-700*	DFC Low Helix Finisher - Upcut	57
Collets	ER Precision Inch	77	57-000	SC 2F Downcut Spiral	37	66-750*	DFC Low Helix Cutter - Upcut	57
Collets	ER 20, 25, 32, 40 Precision Metric	78	57-200	SC 2F Downcut Spiral Wood Rout	37	66-775*	DFC Low Helix Rougher Finisher	58
33-50	Collet Life Plug	77	57-200MD	SC Marathon Wood Rout Downcut	37	66-800*	DFC Compression	58
37-00*	SC 1F 60° Engraving Tools	19	57-400*	SC 2F Downcut Spiral Wood Rout	38	66-900*	SC High Performance Composite Router	59
37-20*	SC 1F 30° Engraving Tools	19	57-600*	SC 2F Downcut "O" Flute	38	67-000	SC Fiberglass Burr Bits	60
37-50/60	Carbide 2F V Bottom	19	57-900	SC 2F Downcut Heavy Duty	38	67-250	3F Diamond Grit Tools	60
37-70	CT 2F Dibond/Alucobond Folding Tool	20	60-000	SC 3F High Helix Chipbreaker	39	67-200*	SC 3F Phenolic Cutter	61
37-80	CT 2F Lettering Bits	20	60-000	SC 3F Low Helix Chipbreaker	39	67-220*	PCD 3F Progressive Chipbreaker	61
40-50	CT 2F Round & Rout	20	60-090*	SC 3F Upcut Lock Mortise	40	67-400*	SC Un-Ruffer	62
42-00	CT 2F Corner Round	21	60-100C	SC 2F Chipbreaker/Finisher	42	67-500*	SC Carbon Graphite Tool	62
47-00	CT 2F MDF Panel Bits	21	60-100MC*	SC Marathon Compression	40	67-800*	SC 8 Facet Drills	63
90-00	T Slot Cutter	21	60-100PLR	2F Polaris Compression Spiral	41	68-000	2F PCD Tipped Tools	64
29-000	HSS Hollow Core Cutters	22	60-100MW*	SC Max Life Compression Spiral	41	68-100	PCD 1F Compression	64
29-050*	Diamond Grit Hogger	22	60-100DC	SC Tuff Core Compression	42	68-200*	PCD 2F SERF Cutter	65
29-100/	SC Honeycomb Hogger	23	60-200*	SC 3F Low Helix Finisher	43	68-300*	PCD 3F SERFIN™ Cutter	65
29-100B*			60-300	SC 2F Chipbreaker Finisher	43	68-400*	PCD 2F Ballnose	65
30-000*	Replaceable Ring Type Honeycomb Cutter	23	60-350	SC 3F Chipbreaker Finisher	44	68-900	PCD 8 Facet Drills	66
30-300	HSS Integral Shank Honeycomb Hogger Cutter	24	60-600	SC 4F High Velocity Compression Spiral	44	70-100	CT Blade and Arbor	66
30-700	Reduced Weight Honeycomb Cutter	24	60-700	SC 4F High Velocity Spiral	44	70-200	SC Flush Mount Blade	67
31-000	HSS Cutter	25	60-800	SC 2F Roughers	45	70-300	CT Flush Mount Blade	67
31-100	HSS Honeycomb Cutter with Teeth	25	60-900	SC 3F Heavy Duty Hogger	45	70-500*	HSS Plastic Drill	68
32-200	HSS 3 Piece Honeycomb Hogger	26	60-950	SC 2F Heavy Duty Chipbreaker/Finisher	45	72-000*	SC Boring Bits	69
34-000	Aircraft Panel Tools	26	61-000	SC 1F "O" Flute Straight	46	77-100*	SC 2F & 3F Taper Tools	70
34-100*	Potted Fastener Tool	27	61-000P	SC 1F "O" Flute Straight	46	80-000	HSS 3F Taper Pin Router	70
34-550	Perske (SYOZ)/DIN6388 Collets & Nuts	79	61-200	SC 1F Straight Wood Rout	47	81-000	HSS 2F Lo Helix	71
34-700	Ultra High-Speed ER Coated Nuts	79	61-400*	SC 1F Straight	47	81-100	SC 2F Extrusion Cutter	71
40-000	HSS 1F Upcut Spiral	28	62-600	SC 1F "O" Flute Downcut Spiral	47	83-300	SC 2F Stainless Steel Cutter	71
40-000	HSS 1F Downcut Spiral	28	62-700	SC 1F Downcut "O" Flute	48	85-800*	SC CFRP Drills	72
40-100	HSS 2F Upcut Spiral	29	62-750	SC 1F Downcut "O" Flute	48	86-150	DFC Aerospace Composite Drill (ACD)	73
40-100	HSS 2F Downcut Spiral	29	62-800*	SC 1F Downcut "O" Flute	48	91-000	CT Spoilboard Cutter	73
40-550	HSS 4F Foam Cutters	29	62-850*	SC 1F Downcut "O" Flute	48	91-100	Insert Spoilboard Cutter	73
48-000	CT 1F Straight	30	63-000	SC 1F Upcut Spiral	48			
			63-200	SC 1F Upcut Spiral Wood Rout	49			

\* Available in Metric

# TAKE IT ON

## Production Cutting Tools

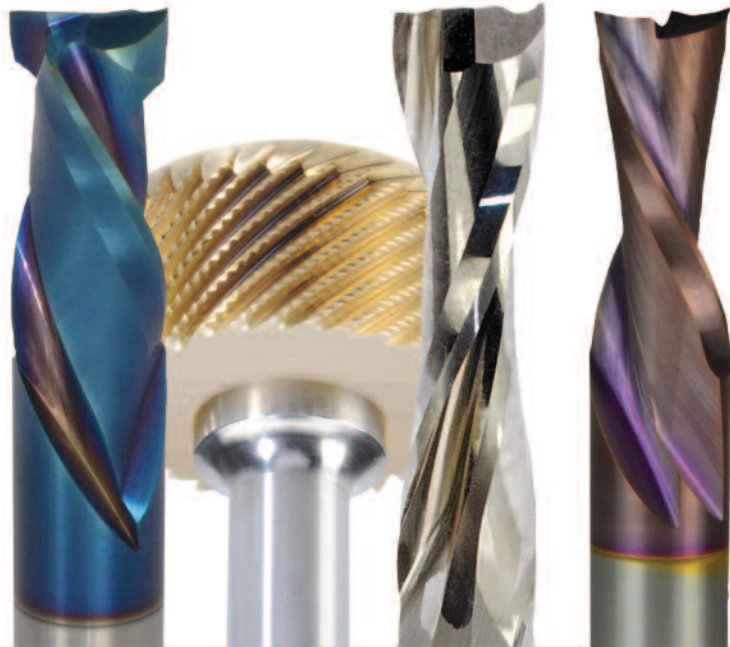

LMT Onsrud has been TAKING ON challenging materials for over 70 years. As materials have changed so has LMT Onsrud's geometry and product diversification. We take pride in manufacturing tooling for CNC routers and CNC machining centers. Wood, Plastic, Aluminum, Composites, Honeycomb, natural and man-made materials – LMT Onsrud has a solution.

## 10-00



### Single Flute - High Speed Steel O Flute Straight

Combines an open flute design with single flute geometry to provide optimum chip removal at fast feed rates. Excellent for hand-fed operations.

**Usage** ABS, polycarbonate, polyethylene, PVC, polypropylene, polystyrene, extruded acrylic, HDPE, UHMW, and natural wood

**Material** **SW** **SP** See Selection Guide - pg. 2 - 12

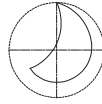

Part Number	Cutting DIA	LoC	SHK DIA	OAL
10-00	1/16	3/16	1/4	2
10-01	3/32	3/8	1/4	2
10-02	1/8	3/8	1/4	2
10-20	1/8	1/2	1/4	2
10-22	3/16	3/4	1/4	2
10-07	1/4	1	1/4	2-3/8
10-78	1/4	1-1/4	1/4	2-5/8

## 11-00



### Single & Double Flute - High Speed Steel O Flute Straight

Designed for cutting softer more flexible plastics. Single flute for faster feed rates. Double flute for smoother finish. Excellent for hand-fed operations.

**Usage** ABS, polycarbonate, polyethylene, polystyrene, PVC, polypropylene extruded acrylic, HDPE, UHMW

**Material** **SP** **HP** See Selection Guide - pg. 2 - 12

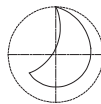

Single Flute

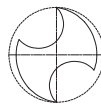

Double Flute

#### SINGLE FLUTE

Part Number	Cutting DIA	LoC	SHK DIA	OAL
11-01	1/8	1/2	1/4	2
11-75*	1/8	5/8	1/4	3-1/4
11-77*	3/16	3/4	1/4	3-1/4
11-71*	1/4	3/4	1/4	3-1/4
11-07	1/4	1	1/4	2-3/8
11-09	3/8	1	3/8	2-1/2

#### DOUBLE FLUTE

Part Number	Cutting DIA	LoC	SHK DIA	OAL
11-00	3/16	5/8	1/4	2
11-02	1/4	3/4	1/4	2-1/8
11-72*	1/4	3/4	1/4	3-1/4
11-76*	1/4	3/4	1/4	3-3/4
11-04	1/4	1	1/4	2-3/8
11-78*	1/4	2	1/4	3-1/4
11-74*	3/8	1	3/8	3-1/2

\*These tools are designed and tolerated for Air Routers with guide bushing.



**15-50**

## Single Flute - High Speed Steel Dor-Bits

Designed to rout steel doors.

**Usage** Metal clad doors  
(15-50 and TIN15-50)  
Fiberglass doors (TIN15-50)

**Material**  See Selection Guide - pg. 2 - 12

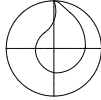

Part Number	Cutting DIA	LoC	SHK DIA	OAL	Door Machine
15-52	1/2	2-1/4	1/2	5-1/4	RUVO
15-53	1/2	2-1/2	1/2	5-1/2	RUVO
15-54	1/2	2-1/2	1/2	5	ACE
15-55*	1/2	2-1/2	1/2	5-1/2	FALCON
15-57*	1/2	2-1/2	1/2	5-1/2	NORFIELD
15-60	1/2	2-1/2	1/2	5-1/2	RUVO
15-61*	1/2	2-1/2	1/2	5-1/2	

HELIX ANGLE  $\approx 18^\circ - 32^\circ$

\*Have Flats

### TIN COATED

Part Number	Cutting DIA	LoC	SHK DIA	OAL	Door Machine
TIN15-52	1/2	2-1/4	1/2	5-1/4	RUVO
TIN15-53	1/2	2-1/2	1/2	5-1/2	RUVO
TIN15-54	1/2	2-1/2	1/2	5	ACE
TIN15-55*	1/2	2-1/2	1/2	5-1/2	FALCON
TIN15-57*	1/2	2-1/2	1/2	5-1/2	NORFIELD
TIN15-60	1/2	2-1/2	1/2	5-1/2	RUVO
TIN15-61*	1/2	2-1/2	1/2	5-1/2	

\*HAVE FLATS



## Three Flute - High Speed Steel TIN Coated CNC Dor-Bits

Downcut tools designed specifically for machining metal clad doors in a CNC environment. The tool geometry facilitates piercing steel and produces a superior cut for door lites and hardware openings.

**Usage** Metal clad or fiberglass doors

**Material**  See Selection Guide - pg. 2 - 12

### TIN COATED

Part Number	Cutting DIA	LoC	SHK DIA	OAL	Door Machine
TIN15-75	1/2	3	1/2	6	KVAL

HELIX ANGLE  $\approx 18^\circ$

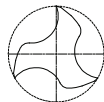
**15-75**

## Single Flute - High Speed Steel Straight Pilot

Straight flute tools with boring points and pilots are the workhorse of the mobile home, modular home and RV industries.

**Usage** Wood panels, vinyl coated panels, wall board and aluminum layered materials

**Material**  See Selection Guide - pg. 2 - 12

Part Number	Cutting DIA	LoC	SHK DIA	OAL
18-00	1/4	3/4	1/4	2-3/4
18-02	3/8	7/8	3/8	2-7/8

**18-00**

## 20-00



### Single Flute - High Speed Steel Downcut Spiral Pilot

Spiral tools designed to push chips away from the operator in mobile home and RV manufacturing plants.

**Usage** Aluminum and plywood sandwich panels, vinyl coated panels, wall board, drywall and layered material

**Material**  See Selection Guide - pg. 2 - 12

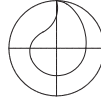

Part Number	Cutting DIA	LoC	SHK DIA	OAL
20-00	1/4	3/4	1/4	3
20-02	3/8	1	3/8	3-7/16
20-03	1/2	1-1/4	1/2	4

HELIX ANGLE ≈ 21° - 38°

## 20-10



### Single Flute - High Speed Steel Drywall Bit

Spiral flute tools designed to make cut outs in drywall. Used in manufactured housing and on site construction.

**Usage** Drywall cut outs

**Material**  See Selection Guide - pg. 2 - 12

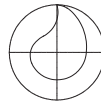

Part Number	Cutting DIA	LoC	SHK DIA	OAL
20-10	3/16	1	1/4	3-1/4
20-11	1/8	3/4	1/8	2-1/2
20-15	1/8	1	1/8	2-1/2

HELIX ANGLE ≈ 30° - 41°

## 27-00



### Single Flute - Solid Carbide Laminate Trim

Designed to trim counter tops. The pilot bears on the finished surface and acts as a guide to trim flush or with a bevel. Available with boring point if necessary to plunge and rout.

**Usage** Trimming laminate counter tops and trimming plastic parts

**Material**  See Selection Guide - pg. 2 - 12

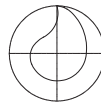

Part Number	Cutting DIA	LoC	SHK DIA	OAL	Style
27-00	1/4	1/4	1/4	1-1/2	Flush
27-01	1/4	1/4	1/4	1-1/2	7° Bevel
27-03	1/4	3/8	1/4	2	Flush

## 27-50



### Double Flute - Solid Carbide Laminate Trim

Tools with a pilot designed to give a satin smooth finish when trimming laminate counter tops.

**Usage** Trimming laminate counter tops and trimming plastic parts

**Material**  See Selection Guide - pg. 2 - 12

Part Number	Cutting DIA	LoC	SHK DIA	OAL	Style
27-50	1/4	7/16	1/4	1-5/8	Flush

**28-20**

## Solid Carbide Double-Bearing Plastic Trim

Spirals designed to trim stacked sheets of plastic in hand-fed applications. They use a double bearing guide to ensure smooth cutting action around a template.

Part Number	Cutting DIA	LoC	SHK DIA	OAL	Flute
28-20	1/4	3/4	1/4	3	2
28-25	1/2	1-1/8	1/2	4	2

HELIX ANGLE ~ 11° - 30°

**Usage** Trimming stacked sheets plastic & laminates

**Material** **SP** **HP** See Selection Guide - pg. 2 - 12

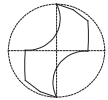

Double Flute

### REPLACEMENT BEARING KITS FOR SERIES 28-20 Solid Carbide Double Bearing Plastic Trim Tool Kits

28-89	KIT for 28-20 Tool
28-88	KIT for 28-25 Tool



## Carbide Tipped Flush Trim

Designed to provide a smooth finished edge on dense, abrasive and laminated materials. A ball bearing guide assists free cutting action. Excellent for hand-fed applications.

**Usage** Natural wood, wood composites, laminated and veneered

**Material** **SW** **HW** **CW**  
**LW** **SP**

See Selection Guide - pg. 2 - 12

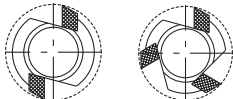

Double Flute Three Flute

Part Number	Cutting DIA	LoC	SHK DIA	OAL	Flute
28-55	1/4	1	1/4	2-1/2	2
28-51	3/8	1/2	1/4	2-1/4	2
28-50	3/8	1	1/4	2-3/4	2
28-53	1/2	1/2	1/4	2	2
28-57	1/2	1	1/4	2-3/4	3
28-54	1/2	1	1/2	3-1/4	2
28-63	1/2	1-1/2	1/2	4-1/4	2
28-64	1/2	2	1/2	4-1/4	2

### REPLACEMENT BEARING KITS FOR SERIES 28-50 Solid Carbide Double Bearing Plastic Trim Tool Kits

28-80	KIT for 1/4" Cutting Dia
28-79	KIT for 3/8" Cutting Dia
28-78	KIT for 1/2" Cutting Dia

**28-50**

## Double Flute - Carbide Tipped Chamfer

Provides a beveled or decorative edge on finished parts.

**Usage** Natural wood and wood composites

**Material** **SW** **HW** **CW**

See Selection Guide - pg. 2 - 12

Part Number	Bevel	LoC	SHK DIA	OAL
29-51	45°	1/2	1/4	2
29-52	45°	1/2	1/2	2-1/2
29-53	25°	3/8	1/4	1-7/8

**29-50**

37-00  
37-20



## Single Flute - Solid Carbide Engraving Tools

The half round engraving tools are offered with a wide range of tip sizes and angles to accommodate many engraving styles.

**Usage** Wood, plastic, aluminum and solid surface

**Material** SW HW SP HP A SSP

See Selection Guide - pg. 2 - 12

Part Number	TIP	Angle	SHK DIA	OAL
37-21	0.005	30	1/4	2
37-23	0.010	30	1/4	2
37-25	0.020	30	1/4	2
37-27	0.030	30	1/4	2
37-29	0.040	30	1/4	2
37-31	0.060	30	1/4	2
37-35	0.090	30	1/4	2
37-39	30 Degree Kit			

### METRIC (All dimensions in mm)

Part Number	TIP	Angle	SHK DIA	OAL
37-25M	0.5	30	6	50
37-27M	0.76	30	6	50
37-29M	1	30	6	50

Part Number	TIP	Angle	SHK DIA	OAL
37-01	0.005	60	1/4	2
37-03	0.010	60	1/4	2
37-05	0.020	60	1/4	2
37-07	0.030	60	1/4	2
37-09	0.040	60	1/4	2
37-11	0.060	60	1/4	2
37-15	0.090	60	1/4	2
37-19	60 Degree Kit			

### METRIC (All dimensions in mm)

Part Number	TIP	Angle	SHK DIA	OAL
37-05M	0.5	60	6	50
37-07M	0.76	60	6	50
37-09M	1	60	6	50

37-50  
37-60



## Double Flute - V Bottom

Designed for V grooving or beveling 90°.

**Usage** Plastic and solid surface, composites, laminated and veneer

**Material** SW HW CW SP HP SSP LW

See Selection Guide - pg. 2 - 12

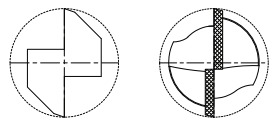

### SOLID CARBIDE

Part Number	Cutting DIA	LoC	SHK DIA	OAL
37-50	3/16	5/8	1/4	2
37-51	1/4	3/4	1/4	2
37-52	3/8	3/4	3/8	2-1/2

HELIX ANGLE ≈ 3° - 5° Shear

### CARBIDE TIPPED

Part Number	Cutting DIA	LoC	SHK DIA	OAL
37-61	1/2	13/32	1/4	1-25/32
37-62	3/4	1/2	1/2	2-1/8
37-63	1	27/32	1/2	2-27/32

## Double Flute - Carbide Tipped Folding Tool for Dibond/Alucobond

Designed for cutting aluminum/plastic sandwich materials with 90° angle and flat bottom.

**Usage** Aluminum/plastic sandwich materials

**Material**  See Selection Guide - pg. 2 - 12

Part Number	Cutting DIA	LoC	SHK DIA	OAL
37-71	1/2	3/8	1/4	2
37-72	1/2	3/8	1/2	2

90° angle and .090 flat for folding material



37-70



## Double Flute - Carbide Tipped Lettering Bits

Designed for V grooving or beveling edges of parts. The tools are designed to cut a wide variety of wood products and produce a clean edge.

**Usage** Wood

**Material**  See Selection Guide - pg. 2 - 12

Part Number	Cutting DIA	LoC	SHK DIA	OAL	ANGLE
37-82	1	0.856	1/2	3-1/2	60°
37-87	1-1/2	0.750	1/2	3	90°
37-92	2	0.577	1/2	3	120°
37-97	2	0.363	1/2	2-5/8	140°

37-80



## Double Flute - Carbide Tipped Round & Rout

Designed to put a radius on the edge and dress the stock. They will provide a smooth finish.

**Usage** Natural wood, wood composites, plastic and solid surface

**Material**  See Selection Guide - pg. 2 - 12

Part Number	Cutting DIA	Sm Cutting DIA	LoC	SHK DIA	OAL	RAD	Material Thickness
40-50	1	1/2	.938	1/2	3-3/16	3/16	3/4
40-52	1-1/8	1/2	.937	1/2	3-3/16	1/4	3/4
40-54	1-3/8	1/2	.938	1/2	3-3/16	3/8	3/4
40-55	1-3/8	1/2	1.437	1/2	3-11/16	3/8	1-3/8

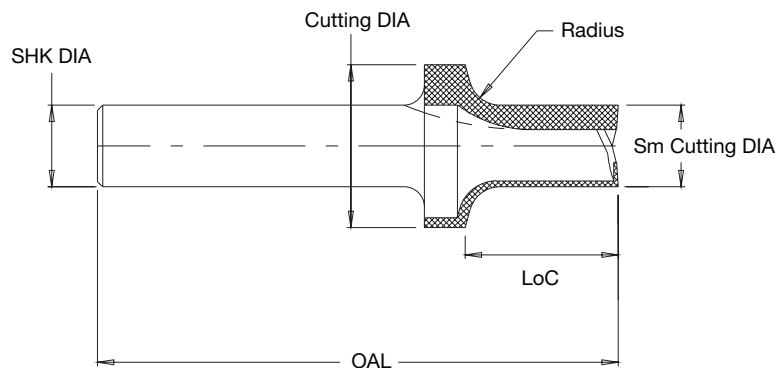

40-50



## 42-00



### Double Flute - Carbide Tipped Corner Round

Quarter round profile tools feature up shear geometry for better finishes.

**Usage** Natural wood, wood composites and solid surface

**Material** **SW HW CW SSP**  
See Selection Guide - pg. 2 - 12

Part Number	Radius	Cutting DIA	LoC	SHK DIA	OAL
42-10	1/8	3/4	3/8	1/4	2-1/8
42-03	5/32	13/16	15/32	1/4	2-3/32
42-01	3/16	7/8	1/2	1/4	2
42-02	1/4	1	7/16	1/4	1-29/32
42-04	5/16	1-1/8	9/16	1/4	2-1/4
42-05	3/8	1-1/4	5/8	1/4	2-1/32
42-06	1/2	1-1/2	3/4	1/4	2-5/32
42-07	1/2	1-1/2	3/4	1/2	2-11/16
42-08	3/4	2	1-1/32	1/2	3

## 47-00



### Double Flute - Carbide Tipped MDF Panel Tools

These cutters can create 12 cabinet combinations by combining different stile and panel cutters to get the desired shape in MDF material.

**Usage** MDF

**Material** **CW** See Selection Guide - pg. 2 - 12

Part Number	Cutting DIA	SHK DIA	OAL	Description
47-02	7/8	1/2	2-1/2	Bead Profile - Stile Bits
47-04	1-1/4	1/2	2-1/2	Traditional Profile - Stile Bits
47-06	1-1/4	1/2	2-1/2	Ogee Profile - Stile Bits
47-08	1-1/4	1/2	2-1/2	Straight Profile - Stile Bits
47-10	1-1/2	1/2	2-1/2	Cove Profile - Panel Bits
47-12	1-1/2	1/2	2-1/2	Straight Profile - Panel Bits
47-14	1-1/2	1/2	2-1/2	Ogee Profile - Panel Bits

#### TOOL COMBINATIONS

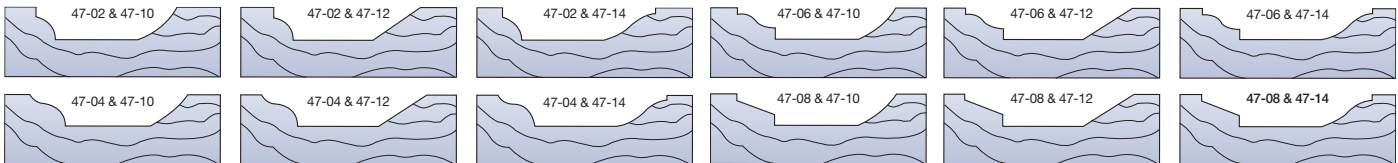

## T Slot Cutter

Designed to bore a hole and rout a T shape slot for plaques and frames to provide for built in wall mounting capabilities.

**Usage** Natural wood, wood composites

**Material** **SW HW CW**  
See Selection Guide - pg. 2 - 12

#### SOLID CARBIDE

Part Number	Cutting DIA	LoC	Neck	SHK DIA	OAL	Flutes
90-06	3/8	3/8	3/16	1/4	1-5/8	2

## 90-00



## HSS Hollow Core Cutters

This specialized cutter is designed to vertically cut the honeycomb cells producing a clean, flag free edge. The core material will remain attached at the bottom and can be removed using one of our valve style honeycomb cutters. This product along with our 31-100 or 30-000 series tools is an effective combination to create pockets in honeycomb core and get a perfectly clean edge.

**Usage** Honeycomb

Part Number	Cutting DIA	LoC	SHK DIA	OAL
29-003	1/4	1-1/2	1/4	3-3/4
29-006	3/8	1-7/8	3/8	3-3/4
29-009	1/2	2-7/8	1/2	5
29-012	5/8	2-7/8	5/8	5
29-015	3/4	2-7/8	3/4	5

29-000



## Diamond Grit Hogger

Diamond grit hoppers are used on abrasive cores (graphite, phenolic, or fiberglass) in order to achieve long tool life. The tools are available in a ball nose version and as a traditional hogger capable of holding existing honeycomb blades. A 35% weight reduction has been designed into the larger diameter tools resulting in better performance on 3 or 5 axis machines.

**Note:** Cutting blades sold separately.

**Usage** Honeycomb

**Note:** 30% - 50% max radial engagement.



### BALL NOSE

Part Number	Cutting DIA	LoC	SHK DIA	OAL
29-053	1/4	1 1/4	1/4	4
29-058	3/8	2 1/2	1/2	4
29-063	1/2	3	1/2	5
29-068	3/4	3	1/2	5
29-074	1	2	3/4	4

### METRIC

Part Number	Cutting DIA	LoC	SHK DIA	OAL
29-054	6	32	6	100
29-056	10	60	10	120
29-061	12	75	12	120
29-065	20	75	20	120

29-050



HONEYCOMB HOGGER					CUTTING BLADE OPTIONS							SPARE PARTS	
Part #	Cutting Diameter	Hogger Depth	Shank DIA	OAL	Blade Diameter	HSS	HSS w/Teeth	Solid Carbide	Solid Carbide w/Teeth	Diamond Plated	HSS Saw	Adapter Ring	Screw
29-052	1/4 (6.35mm)	1 1/4	1/4	4	-	-	-	-	-	-	-	-	-
29-057	.345 (8.76mm)	2 1/2	1/2	4	3/8 (9.52mm)	30-016	30-316	-	-	-	-	-	HRD51646
29-062	.470 (11.94mm)	3	1/2	5	1/2 (12.7mm)	30-017	30-317	-	-	-	-	-	HRD51646
29-067	.720 (18.28mm)	3	1/2	5	3/4 (19.05mm)	-	-	30-015	30-318	-	-	-	30-011-2
29-072	.970 (24.63mm)	1	1/2	3	1 (25.4mm)	-	-	30-012	30-313	30-113	30-213	-	30-011-2
29-073	.970 (24.63mm)	2	3/4	5	1 (25.4mm)	-	-	30-012	30-313	30-113	30-213	-	30-011-2
29-078	1.470 (37.33mm)	1	1/2	3	1 1/2 (38.10mm)	-	-	30-014	30-314	30-114	30-214	30-020-3	30-020-4
29-079'	1.470 (37.33mm)	2	3/4	5	1 1/2 (38.10mm)	-	-	30-014	30-314	30-114	30-214	30-020-3	30-020-4
29-083	1.742 (44.24mm)	1	1/2	3	1.772 (45mm)	-	-	30-026	30-326	30-126 <sup>2</sup>	30-226 <sup>2</sup>	30-020-3	30-020-4
29-084'	1.742 (44.24mm)	2	3/4	5	1.772 (45mm)	-	-	30-026	30-326	30-126 <sup>2</sup>	30-226 <sup>2</sup>	30-020-3	30-020-4
29-088	1.970 (50.03mm)	1	5/8	3	2 (50.8mm)	-	-	30-022	30-322	30-122	30-222	30-020-3	30-020-4
29-089	1.970 (50.03mm)	2	3/4	5	2 (50.8mm)	-	-	30-022	30-322	30-122	30-222	30-020-3	30-020-4
29-093	2.450 (62.23mm)	1	5/8	3	2.480 (63mm)	-	-	30-036	30-336	30-136	30-236	30-030-3	30-030-4
29-095	2.970 (75.43mm)	1	3/4	3	3 (76.20mm)	-	-	30-032	30-332	30-132	30-232	30-030-3	30-030-4
29-096'	2.970 (75.43mm)	1	3/4	4	3 (76.20mm)	-	-	30-032	30-332	30-132	30-232	30-030-3	30-030-4
29-098	3.970 (100.83mm)	1	3/4	3	4 (101.6mm)	-	-	30-042	30-342	30-142	30-242	30-040-3	30-040-4
29-099'	3.970 (100.83mm)	1	3/4	4	4 (101.6mm)	-	-	30-042	30-342	30-142	30-242	30-040-3	30-040-4

1 = non-stock standard. 4 week lead time  
2 = 50mm diameter honecomb blade

See page 25 for Images of Cutting Blades

## 29-100/ 29-100B

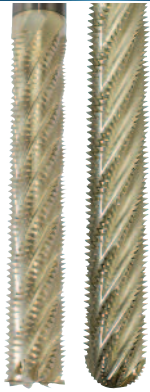

## Solid Carbide Honeycomb Hogger (Coated)

Designed to be a versatile tool and cut most honeycomb core materials. The solid carbide body offers long tool life while the proven hogger geometry shreds the core and evacuates chips. The long flute length allows for deep pocket applications and can also be used to surface large areas. Hoggers are coated with ZRN.

**Usage** Honeycomb

### METRIC UPCUT (All dimensions in mm)

Part Number	Cutting DIA	LoC	SHK DIA	OAL
29-120	12 (.472")	60	12	150
29-135	16 (.629")	80	16	150

Part Number	Cutting DIA	LoC	SHK DIA	OAL
29-110	1/4 (6.35mm)	1-1/4	1/4	4
29-115	3/8 (9.52mm)	2	3/8	4
29-125	1/2 (12.7mm)	3	1/2	6
29-130	1/2 (12.7mm)	4-1/2	1/2	6-1/2
29-140	3/4 (19.05mm)	3	3/4	6
29-145	3/4 (19.05mm)	4-1/2	3/4	6-1/2

### BALLNOSE

Part Number	Cutting DIA	LoC	SHK DIA	OAL
29-130B	1/2 (12.7mm)	4-1/2	1/2	6-1/2
29-140B	3/4 (19.05mm)	3	3/4	6
29-145B	3/4 (19.05mm)	4-1/2	3/4	6-1/2

## 30-000



## Replaceable Ring Type Honeycomb Cutter

These tools are for contouring, carving and chamfering cuts of .25" or less. The unique patented holding system prevents the solid carbide blades from coming out of the holder if it is fractured.

The HSS saw blades and the diamond plated blades dish on the bottom so they clear the cut core finish like the hollow ground solid carbide style rings. The solid carbide rings may be reground several times at LMT Onsrud making them very economical to use.

The HSS saw and diamond plated blades are disposable, offering the convenience of a constant diameter.

**Note:** Cutting blades sold separately.

### Usage

For contouring, carving and chamfering cuts

SHANK ASSEMBLY			CUTTING BLADE OPTIONS				SPARE PARTS	
Part #	Blade Diameter	Shank DIA	Solid Carbide	Solid Carbide with Teeth	Diamond Plated	HSS Saw	Adapter Ring	Screw
30-011	1" (25.4mm)	1/2	30-012	30-313	30-112	30-213	-	30-011-2
30-021	2" (50.8mm)	1/2	30-022	30-322	30-122	30-222	30-020-3	30-020-4
30-031	3" (76.2mm)	1/2	30-032	30-332	30-132	30-232	30-030-3	30-030-4
30-041	4" (101.6mm)	1/2	30-042	30-342	30-142	30-242	30-040-3	30-040-4

See page 25 for Images of Cutting Blades

### METRIC UPCUT (All dimensions in mm)

SHANK ASSEMBLY			CUTTING BLADE OPTIONS				SPARE PARTS	
Part #	Blade Diameter d <sub>3</sub>	d <sub>2</sub>	Solid Carbide	Solid Carbide with Teeth	Diamond Plated	HSS Saw	Adapter Ring	Screw
30-010	25	12	30-052	-	30-115	30-215	-	30-011-2
30-013	45	12	30-026	30-326	30-126	30-226	30-020-3	30-020-4
30-023	63	12	30-036	30-336	30-136	30-236	30-030-3	30-030-4

See page 25 for Images of Cutting Blades



## HSS Integral Shank Honeycomb Hogger Cutter

The spiral hogger geometry ground integral to the shank allows for faster feed rates and deeper cuts than any previous cutter. The availability of several different blades makes this cutter suitable for most core types. The hogger design also imparts less force as it evacuates and shreds scrap.

**Note:** Cutting blades sold separately.

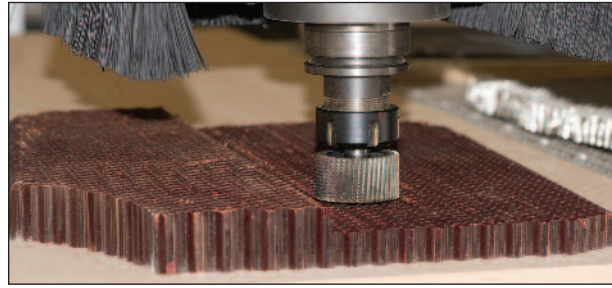

30-300



**Usage** CNC machining of honeycomb core

HONEYCOMB HOGGER					CUTTING BLADE OPTIONS						SPARE PARTS	
Part #	Cutting Diameter	Hogger Depth	Shank DIA	OAL	Blade Diameter	Solid Carbide	Solid Carbide w/Teeth	Diamond Plated	HSS Saw	Adapter Ring	Screw	
30-310	7/8 (22.22mm)	1 1/2	1/2	3 1/2	1 (25.4mm)	30-012	30-313	30-113	30-213	-	30-011-2	
30-315	1 1/4 (31.75mm)	1 1/2	1/2	3 1/2	1 1/2 (38.1mm)	30-014	30-314	30-114	30-214	30-020-3	30-020-4	
30-321	1 3/4 (44.45mm)	1 1/2	1/2	3 1/2	2 (50.8mm)	30-022	30-322	30-122	30-222	30-020-3	30-020-4	
30-331	2 3/4 (69.85mm)	1	1/2	3 1/2	3 (76.2mm)	30-032	30-332	30-132	30-232	30-030-3	30-030-4	
30-341	3 3/4 (95.25mm)	1	3/4	3 1/2	4 (101.6mm)	30-042	30-342	30-142	30-242	30-040-3	30-040-4	

See page 25 for Images of Cutting Blades

## Reduced Weight Honeycomb Cutter

35% weight reduction has been designed into the larger diameter tools resulting in better performance on 3 or 5 axis machines. Part lifting and flagging have also been reduced due to the new tooth and flute design. Existing honeycomb blades will mount on these hoggers.

**Note:** Cutting blades sold separately.

**Usage** CNC Machining of Honeycomb Core

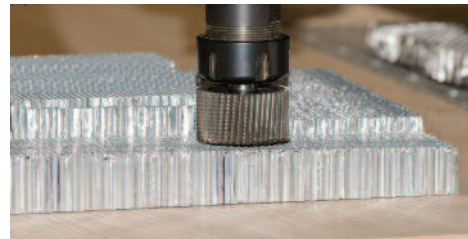

30-700



HONEYCOMB HOGGER					CUTTING BLADE OPTIONS							SPARE PARTS	
Part #	Cutting Diameter	Hogger Depth	Shank DIA	OAL	Blade Diameter	HSS	HSS w/Teeth	Solid Carbide	Solid Carbide w/Teeth	Diamond Plated	HSS Saw	Adapter Ring	Screw
30-703	.345 (8.76mm)	1	1/2	3	3/8 (9.52mm)	30-016	30-316	-	-	-	-	-	HRD51646
30-705	.470 (11.93mm)	1	1/2	3	1/2 (12.7mm)	30-017	30-317	-	-	-	-	-	HRD51646
30-707	.720 (18.28mm)	1	1/2	3	3/4 (19.05mm)	-	-	30-015	30-318	-	-	-	30-011-2
30-710	.970 (24.63mm)	1	1/2	3	1 (25.4mm)	-	-	30-012	30-313	30-113	30-213	-	30-011-2
30-715	1.470 (37.33mm)	1	1/2	3	1 1/2 (38.10mm)	-	-	30-014	30-314	30-114	30-214	30-020-3	30-020-4
30-720	1.742 (44.24mm)	1	1/2	3	1.772 (45mm)	-	-	30-026	30-326	30-126 <sup>1</sup>	30-226 <sup>1</sup>	30-020-3	30-020-4
30-725	1.970 (50.03mm)	1	5/8	3	2 (50.8mm)	-	-	30-022	30-322	30-122	30-222	30-020-3	30-020-4
30-730	2.450 (62.23mm)	1	5/8	3	2.480 (63mm)	-	-	30-036	30-336	30-136	30-236	30-030-3	30-030-4
30-735	2.970 (75.43mm)	1	3/4	3	3 (76.20mm)	-	-	30-032	30-332	30-132	30-232	30-030-3	30-030-4
30-740	3.970 (100.83mm)	1	3/4	3	4 (101.6mm)	-	-	30-042	30-342	30-142	30-242	30-040-3	30-040-4

<sup>1</sup> = 50mm diameter honecomb blade

See page 25 for Images of Cutting Blades

## 31-000



### High Speed Steel Cutter

Designed primarily for use on aluminum core, offering the versatility of smaller sizes for use on hand-held machines in field or maintenance type repairs. This cutter offers the strength of an integral shank and blade that has an edge sharpness unattainable with any other material. This sharpness and the relieved bottom yield part surfaces that require a minimum of preparation before bonding operation.

**Usage** Aluminum Core

Part Number	Cutting DIA	SHK DIA	OAL
31-010	1/2	1/4	2-1/16
31-015	3/4	1/4	2-3/32
31-020	1	1/4	2-1/8
31-025	1-1/2	1/2	2-1/4
31-030	2	1/2	2-3/4
31-040	3	1/2	2-15/16

Core Type	Rating
Aluminum, Lo Density (Less than 5#/cuft)	1
Aluminum, Hi Density (More than 5#/cuft)	2
Paper	2
Paper, Reinforced	N
Fiberglass	N
Phenolic	N
Polycarbonate	N
Aramid	N

1 - Excellent, 2 - Good, N - Not Recommended

## 31-100



### High Speed Steel Honeycomb Cutter With Teeth

Small diameter honeycomb cutters were designed to offer the flexibility of cutting small slots or pockets in honeycomb core. The tools are versatile and can be used on CNC machines or hand held machines for field or maintenance type repairs.

**Usage** For contouring, carving, pocketing, and chamfer cuts

Part Number	Cutting DIA	SHK DIA	OAL
31-102TCN	3/8	1/4	3
31-104TCN	1/2	1/4	3
31-106TCN	5/8	1/4	3
31-108TCN	3/4	1/4	3

### Cutting Blades for Cutters and Hoggers

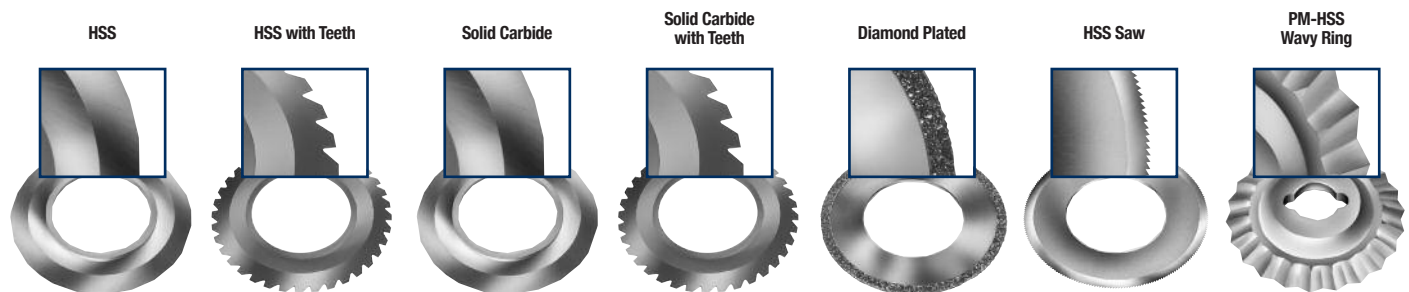

## HSS Three Piece Honeycomb Hogger (Coated)

Designed with more aggressive hogger geometry than the 32-000 series. Both the hogger and blade with teeth have a fine tooth grind pattern resulting in increased feed rates and improved part finish. All hoggers and blades are coated with a ZRN coating for increase in tool life. All hogger assemblies require a shank, a hogger and a blade. This design also allows the tool to be use without the hogger by replacing the hogger with a spacer.

**Note:** Hoggers, Arbors and Cutting Blades Sold Separately.

**Usage** Fast removal of excess core

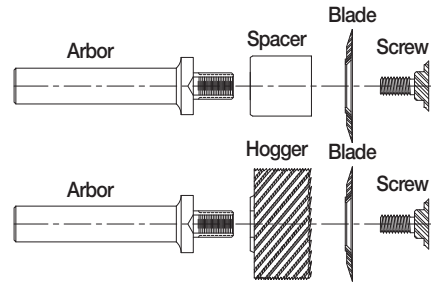

HONEYCOMB HOGGER			ARBOR			CUTTING BLADE OPTIONS			SPARE PARTS	
Part #	Cutting Diameter	Hogger Depth	Part #	Shank DIA	OAL	Blade Diameter	Solid Carbide	Solid Carbide w/Teeth	Spacer	Retaining Screw
32-210	0.94" (23.88mm)	1" (25.4mm)	32-221	3/8"	4"	1" (25.4mm)	32-412	32-512	32-221-3	32-221-4
32-225	1.94" (49.28mm)	1" (25.4mm)	32-231	1/2"	4"	2" (50.8mm)	32-422	32-522	32-231-3	32-231-4
			32-241	5/8"	4"					
32-235	2.94" (74.68mm)	1" (25.4mm)	32-231	1/2"	4"	3" (76.2mm)	32-432	32-532	32-231-3	32-231-4
			32-241	5/8"	4"					
32-220	1.72" (43.69mm)	1" (25.4mm)	32-231	1/2"	4"	1.77" (45mm)	32-426	32-526	32-231-3	32-231-4
			32-241	5/8"	4"					
32-230	2.42" (61.47mm)	1" (25.4mm)	32-231	1/2"	4"	2.48" (63mm)	32-436	32-536	32-231-3	32-231-4
			32-241	5/8"	4"					

32-201 - Wrench for 32-200 Tools (for Shank Diameters 1/2" & 5/8")

32-202 - Wrench for 32-200 Tools (for Shank Diameters 3/8")

32-205 - Keystock Replacement

See page 25 for Images of Cutting Blades

## Aircraft Panel Tools

This modular tool is designed to produce slots in composite panels so potting compound can be applied to strengthen the edge. This tool consists of a PCD arbor which accepts a diamond grit or HSS under cutting tool to be screwed into it.

**Usage** HCC Panels

Part Number	Cutting DIA	LoC	SHK DIA	
34-008	1/2	-	1/2	Arbor (non-cutting)
34-010	1/2	1/4	1/2	PCD Arbor
34-022	7/8	0.130	n/a	Diamond Grit Cutter
34-024	7/8	0.250	n/a	Diamond Grit Cutter
34-026	7/8	0.380	n/a	Diamond Grit Cutter
34-028	7/8	0.500	n/a	Diamond Grit Cutter
34-030	7/8	0.630	n/a	Diamond Grit Cutter
34-042	7/8	0.130	n/a	HSS Cutter
34-044	7/8	0.250	n/a	HSS Cutter
34-046	7/8	0.380	n/a	HSS Cutter
34-048	7/8	0.500	n/a	HSS Cutter
34-050	7/8	0.630	n/a	HSS Cutter

## 34-000

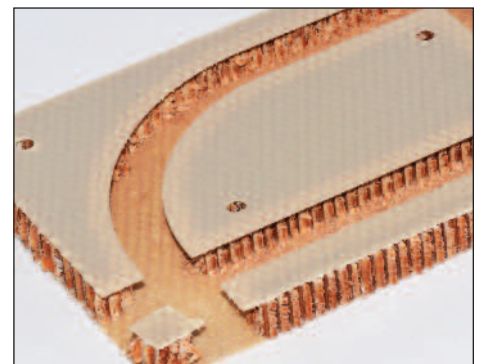

## Potted Fastener Tools (Coated)



**NEW**

The tool was designed to eliminate the inconsistencies in producing the holes in aircraft interior panels to mount potted, glued in, fasteners. This tool for composite panels will plunge and shred the HCC. In aluminum panels an entry hole is required but the HCC shred is clean and effective. Coated for increased tool life.

**Usage** Honeycomb Panel

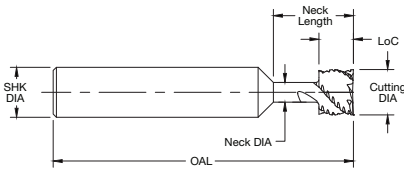

Hole for Fastener Produced with 34-100 Series

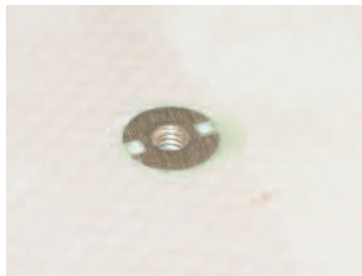

Potted Fastener

Part Number	Cutting DIA	LoC	SHK DIA	Neck DIA	Neck Length	OAL
34-107	0.453	0.13	1/2	0.18	0.80	3
34-109	0.453	0.25	1/2	0.18	0.80	3
34-111	0.453	0.38	1/2	0.18	0.80	3
34-113	0.453	0.50	1/2	0.18	0.80	3
34-115	0.500	0.13	1/2	0.19	0.80	3
34-117	0.500	0.25	1/2	0.19	0.80	3
34-119	0.500	0.38	1/2	0.19	0.80	3
34-121	0.500	0.50	1/2	0.19	0.80	3
34-123	0.563	0.13	1/2	0.22	0.80	3
34-125	0.563	0.25	1/2	0.22	0.80	3
34-127	0.563	0.38	1/2	0.22	0.80	3
34-129	0.563	0.50	1/2	0.22	0.80	3
34-131	0.630	0.13	5/8	0.25	0.80	3
34-133	0.630	0.25	5/8	0.25	0.80	3
34-135	0.630	0.38	5/8	0.25	0.80	3
34-137	0.630	0.50	5/8	0.25	0.80	3

### METRIC (All dimensions in mm)

Part Number	Cutting DIA	LoC	SHK DIA	Neck DIA	Neck Length	OAL
34-106	11.51	3.30	12	4.57	20.32	76
34-108	11.51	6.35	12	4.57	20.32	76
34-110	11.51	9.65	12	4.57	20.32	76
34-112	11.51	12.70	12	4.57	20.32	76
34-114	12.70	3.30	12	4.83	20.32	76
34-116	12.70	6.35	12	4.83	20.32	76
34-118	12.70	9.65	12	4.83	20.32	76
34-120	12.70	12.70	12	4.83	20.32	76
34-122	14.29	3.30	12	5.59	20.32	76
34-124	14.29	6.35	12	5.59	20.32	76
34-126	14.29	9.65	12	5.59	20.32	76
34-128	14.29	12.70	12	5.59	20.32	76
34-130	16	3.30	16	6.35	20.32	76
34-132	16	6.35	16	6.35	20.32	76
34-134	16	9.65	16	6.35	20.32	76
34-136	16	12.70	16	6.35	20.32	76

## Technical Data

**34-100**

RPM	Plunge Feed Rate	Feed Rate
10,000	40 IPM	80 IPM

**Note:** Must PRE-DRILL for Aluminum

## Solid Carbide Honeycomb Compression (Coated)

Designed for routing Falcon Board®, BioBoard™, Reboard® or similar materials used for graphic display boards. Single pass solution when machining Aluminum and Paper Based (Nomex®) sandwich panels.

Part Number	Cutting DIA	LoC	UPDCUT LoC	SHK DIA	OAL	Flutes
66-405	3/8	1-1/8	0.250	3/8	3	6
66-410	1/2	1-1/8	0.300	1/2	3	6
66-415	1/2	2-1/8	0.300	1/2	4	6

**Usage** Sandwich panels:  
Aluminum facings w/ Aluminum core;  
Fiberglass facings w/ Nomex® core;  
and Cardboard Honeycomb

### CUTTING PARAMETERS HONEYCOMB CORE AND SANDWICH PANELS

Aluminum Facings w/Aluminum Core		Fiberglass Facings w/Paper Core (Nomex®)		Cardboard Honeycomb	
RPM	Feed Rate	RPM	Feed Rate	RPM	Feed Rate
18,000	90-120 IPM	12,000-15,000	90-120 IPM	20,000	60 IPM

66-400



**NEW**

## Single Flute - High Speed Steel Upcut Spiral

Designed for routing applications where speed and chip removal are primary considerations. They are also recommended when grooving, slotting or blind routing.

**Usage** Natural wood, sheet and stacked aluminum

**Material**



See Selection Guide - pg. 2 - 12



Part Number	Cutting DIA	LoC	SHK DIA	OAL
40-001	1/8	3/8	1/4	2-5/8
40-003	3/16	5/8	1/4	2-7/8
40-005	1/4	5/8	1/4	2-3/4
40-009	1/4	3/4	1/2	3-1/4
40-021	5/16	3/4	1/2	3-1/4
40-023	5/16	1	1/2	3-1/2
40-025	21/64	3/4	1/2	3-1/4
40-033	3/8	1	1/2	3-1/2

HELIX ANGLE ≈ 19° - 32° Shear

40-000



## Single Flute - High Speed Steel Downcut Spiral

Designed for through cut routing operations where speed is the primary concern and fixturing is such that both chips and material are better off forced down.

**Usage** Sheet aluminum

**Material**



See Selection Guide - pg. 2 - 12

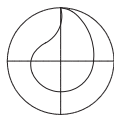

Part Number	Cutting DIA	LoC	SHK DIA	OAL
40-008	1/4	3/4	1/4	2 3/4
40-012	1/4	1	1/4	3

HELIX ANGLE ≈ 19° - 32° Shear

40-000



## 40-100



### Double Flute - High Speed Steel Upcut Spiral

Provides a smoother finish when grooving, slotting or blind routing than do single flute tools. Recommended when fixturing requires upward chip removal.

**Usage** Natural wood sheet, block & plate aluminum

**Material**



See Selection Guide - pg. 2 - 12

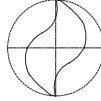

Part Number	Cutting DIA	LoC	SHK DIA	OAL
40-101	1/8	3/8	1/4	2-5/8
40-103	3/16	5/8	1/4	2-7/8
40-153	7/32	7/8	1/4	3
40-105	1/4	5/8	1/4	2-3/4
40-107	1/4	3/4	1/4	2-3/4

Part Number	Cutting DIA	LoC	SHK DIA	OAL
40-107	1/4	3/4	1/4	2-3/4
40-109	1/4	3/4	1/2	3-1/4
40-111*	1/4	1	1/4	3
40-121	5/16	3/4	1/2	3-1/4
40-117	5/16	3/4	3/8	3
40-115	5/16	1	5/16	3
40-123	5/16	1	1/2	3-1/2
40-131*	3/8	1	3/8	3
40-133	3/8	1	1/2	3-1/2
40-135	3/8	1-1/4	1/2	3-3/4
40-137	1/2	1-1/4	1/2	3-1/4
40-139	1/2	1-1/2	1/2	3-1/2
40-141	3/4	1-1/4	1/2	3-1/4

HELIX ANGLE ≈ 19° - 32° Shear

\* These tools are designed and tolerated for air routers with guide bushings.

## 40-100



### Double Flute - High Speed Steel Downcut Spiral

Provides a smoother finish than single flute in trimming and sizing. Recommended when chip flow should be directed down to protect the finish on the top of the material being cut.

**Usage** Natural wood sheet & aluminum extrusions

**Material**



See Selection Guide - pg. 2 - 12

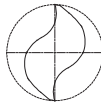

Part Number	Cutting DIA	LoC	SHK DIA	OAL
40-102	1/8	5/16	1/4	2-5/8
40-104	3/16	5/8	1/4	2-7/8
40-106	1/4	5/8	1/4	2-3/4
40-108	1/4	3/4	1/4	2-3/4
40-110	1/4	3/4	1/2	3-1/4
40-112*	1/4	1	1/4	3
40-158*	1/4	1	1/4	3-1/4
40-122	5/16	3/4	1/2	3-1/4
40-116	5/16	1	5/16	3
40-124	5/16	1	1/2	3-1/2
40-134	3/8	1	1/2	3-1/2
40-138	1/2	1-1/4	1/2	3-1/4
40-140	1/2	1-1/2	1/2	3-1/2
40-142	3/4	1-1/4	1/2	3-1/4

HELIX ANGLE ≈ 19° - 32° Shear

\* These tools are designed and tolerated for air routers with guide bushings.

## 40-550



### Four Flute - High Speed Steel Upcut Spiral Foam Cutters

Designed to cut thick foam with upward chipflow.

**Usage** Foam

**Material**



See Selection Guide - pg. 2 - 12



Part Number	Cutting DIA	LoC	SHK DIA	OAL
40-562	1/2	3-5/8	1/2	6
40-564	1/2	4-1/8	1/2	6-1/2

HELIX ANGLE ≈ 25°

## Single Flute - Carbide Tipped Straight

Designed for general usage where faster feed rates, free cutting action and long tool life are essential.

**Usage** Natural wood, wood composites, composite plastic and foam

**Material** HW CW LW FP

See Selection Guide - pg. 2 - 12

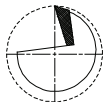

Part Number	Cutting DIA	LoC	SHK DIA	OAL
48-005	1/4	7/8	1/4	2-3/8
48-007	1/4	1	1/4	2-3/8
48-079*	1/4	1	1/4	3-1/4
48-056	3/8	1-1/4	1/2	2-3/4
48-069	1/2	1-1/2	1/2	3

\* These tools are designed and toleranced for Air Routers with guide bushings.



## Double Flute - Carbide Tipped Straight

Designed for general usage where superior balance and vibration free cutting provides a smoother finish along with long tool life.

**Usage** Natural wood, wood composites, composite plastic and foam

**Material** HW CW LW FP

See Selection Guide - pg. 2 - 12

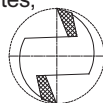

Part Number	Cutting DIA	LoC	SHK DIA	OAL
48-008+	1/8	5/16	1/4	2
48-004	1/4	5/8	1/4	2-1/8
48-006	1/4	7/8	1/4	2-3/8
48-018	1/4	7/8	1/2	2-1/2
48-106	1/4	1	1/4	2-3/8
48-179*	1/4	1	1/4	3-1/4
48-010	5/16	1	1/4	2-1/2
48-012	3/8	3/4	1/4	2-1/4
48-036*	3/8	1	3/8	2-1/2
48-057	3/8	1	1/2	2-1/2
48-058*	3/8	1-1/4	3/8	3
48-158	3/8	1-1/4	1/2	2-3/4
48-014	1/2	3/4	1/4	2-1/8
48-072	1/2	1	1/2	2-1/2
48-076	1/2	1-1/4	1/2	2-3/4
48-080	1/2	1-1/2	1/2	3
48-081	1/2	2	1/2	4
48-183	1/2	2-1/2	1/2	4-1/2
48-015	5/8	1	1/4	2-1/4
48-086	5/8	1-1/4	1/2	2-3/4
48-016	3/4	1	1/4	2-1/4
48-088	3/4	1-1/4	1/2	3
48-215	3/4	2	3/4	4
48-096	7/8	1-1/4	1/2	2-3/4
48-100	1	1-1/4	1/2	2-3/4

+ Solid Carbide

\*These tools are designed and toleranced for Air Routers with guide bushings.



## 49-000



### Double Flute - High Speed Steel Downcut

These double flute downcuts with a drill type point were developed initially as “Aircraft Throwaway” tools. They have many uses in trimming and routing primarily with hand held routers.

**Usage** Aluminum

**Material**  See Selection Guide - pg. 2 - 12

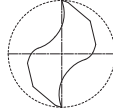

Part Number	Cutting DIA	LoC	SHK DIA	OAL
49-005	1/4	9/16	1/4	2-1/2
49-001	1/4	9/16	1/4	2-3/4
49-007	1/4	9/16	1/4	3-1/4
49-003	3/8	3/4	3/8	2-1/2

THESE TOOLS ARE DESIGNED AND TOLERANCED FOR AIR ROUTERS WITH GUIDE BUSHINGS, + .000 - .006  
HELIX ANGLE ≈ 24°

## 52-000



### Double Flute - Solid Carbide Upcut Spiral

Designed as a general purpose spiral with several times the life of their high speed steel counterparts. They are used when upward chip flow is preferred.

**Usage** Fiberglass, phenolic, acetal, solid surface and aluminum slab

**Material**    See Selection Guide - pg. 2 - 12

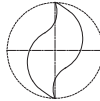

Part Number	Cutting DIA	LoC	SHK DIA	OAL
52-040	1/8	1/2	1/4	2
52-050	5/32	9/16	1/4	2
52-060	3/16	5/8	1/4	2
52-080	1/4	3/4	1/4	2-1/2
52-100	5/16	13/16	3/8	2-1/2
52-120	3/8	7/8	3/8	2-1/2
52-160	1/2	1	1/2	3

HELIX ANGLE ≈ 30°

## 52-200



### Double Flute - Solid Carbide Upcut Spiral Wood Rout

Designed for routing where upward chip removal, tool rigidity, long life and high quality finish is desired.

**Usage** Natural wood, wood composites solid surface, and some plastic

**Material**     See Selection Guide - pg. 2 - 12

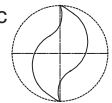

Part Number	Cutting DIA	LoC	SHK DIA	OAL
52-244	1/8	1/2	1/8	2
52-240	1/8	1/2	1/4	2
52-250	5/32	5/8	1/4	2
52-260	3/16	3/4	1/4	2
52-261	3/16	3/4	1/4	2-1/2
52-280	1/4	7/8	1/4	2-1/2
52-285	1/4	1	1/4	2-1/2
52-287	1/4	1-1/8	1/4	3
52-300	5/16	1-1/8	5/16	3
52-310	5/16	1-1/8	1/2	3
52-310L	5/16	1-1/8	1/2	3
52-318*	3/8	1	3/8	3

Part Number	Cutting DIA	LoC	SHK DIA	OAL
52-320	3/8	1-1/8	3/8	3
52-325	3/8	1-1/4	3/8	3
52-330	3/8	1-1/4	1/2	3
52-340	7/16	1	1/2	3
52-360	1/2	1-1/8	1/2	3
52-362	1/2	1-1/4	1/2	3-1/2
52-365	1/2	1-5/8	1/2	3-1/2
52-365L	1/2	1-5/8	1/2	3-1/2
52-367	1/2	2-1/8	1/2	4
52-385	5/8	2-1/8	5/8	4
52-395	3/4	2-1/8	3/4	4

HELIX ANGLE ≈ 30°

\* Special Point (Improved Bottom Finish)

L = Left Hand Rotation



## 52-200B/BL

### Double Flute - Solid Carbide Upcut Spiral Ball Nose

Designed for carving and modeling operations. Their improved tip geometry gives a superior cut compared to most ballnose endmills.

**Usage** Plastic, solid surface, block & plate aluminum natural wood and wood composite

**Material** SW HW CW SP HP A SSP

See Selection Guide - pg. 2 - 12

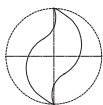

Part Number	Cutting DIA	LoC	SHK DIA	OAL
52-235B	1/16	1/4	1/8	2
52-244B	1/8	1/2	1/8	2
52-240B	1/8	1/2	1/4	2
52-260B	3/16	3/4	1/4	2
52-280B	1/4	7/8	1/4	2-1/2
52-320B	3/8	1-1/8	3/8	3
52-360B	1/2	1-1/8	1/2	3
52-386B	5/8	2-1/4	5/8	4
52-397B	3/4	2-1/2	3/4	5

#### METRIC (All dimensions in mm)

Part Number	Cutting DIA	LoC	SHK DIA	OAL
52-240BM	3	12	6	50
52-280BM	6	22	6	64
52-320BM	10	29	10	76
52-360BM	12	29	12	76

#### EXTENDED LENGTH

Part Number	Cutting DIA	LoC	ERL	SHK DIA	OAL
52-235BL	1/16	1/4	-	1/8	3
52-244BL	1/8	1/2	1-5/8	1/8	3
52-240BL	1/8	1/2	1-5/8	1/4	3
52-260BL	3/16	3/4	1-5/8	1/4	3
52-280BL	1/4	1	2-5/8	1/4	4
52-320BL	3/8	1-1/4	2-5/8	3/8	4
52-360BL	1/2	1-1/2	3-5/8	1/2	5
52-386BL	5/8	2-1/2	3-5/8	5/8	5
52-397BL	3/4	3	4-5/8	3/4	6



## 52-400

### Double Flute - Solid Carbide Upcut Spiral Wood Rout

Designed for routing where upward chip removal, tool rigidity, long life and high quality finish is desired.

**Usage** Natural wood, wood composites, plastic and solid surface

**Material** SW HW CW SP

See Selection Guide - pg. 2 - 12

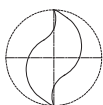

#### METRIC UPCUT (All dimensions in mm)

Part Number	Cutting DIA	LoC	SHK DIA	OAL
52-410	4	16	6	64
52-411	5	20	6	64
52-412	6	25	6	64
52-414	8	25	8	64
52-416	10	35	10	76
52-418	12	35	12	76

HELIX ANGLE ≈ 30°



## 52-550

### Double Flute - Solid Carbide Upcut Foam Cutters

Foam cutters for thick material with upward chip flow.

**Usage** Foam

**Material** FP See Selection Guide - pg. 2 - 12

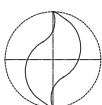

Part Number	Cutting DIA	LoC	SHK DIA	OAL
52-554	1/8	1-1/8	1/4	2-1/2
52-558	3/16	1-1/8	3/16	3
52-560	3/16	1-5/8	3/16	4
52-564	1/4	2-1/4	1/4	4
52-570	5/16	3-1/8	5/16	6
52-574	3/8	3-1/2	3/8	6

HELIX ANGLE ≈ 25°



## 52-600



### Double Flute - Solid Carbide Upcut Spiral O Flute

Low helix geometry designed to cut soft and hard plastic with a smooth finish and upward chip flow.

**Usage** Soft and hard plastic, acrylic, nylon, ABS, PE, acetal, PET, HDPE, UHMW, polycarbonate and solid surface

**Material** **SP** **HP** **SSP**

See Selection Guide - pg. 2 - 12

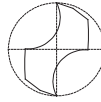

Part Number	Cutting DIA	LoC	SHK DIA	OAL
52-622	1/4	3/8	1/4	2-1/2
52-624	1/4	3/4	1/4	2-1/2
52-638	3/8	1	3/8	3
52-650	1/2	1-1/8	1/2	3-1/2
52-652	1/2	1-5/8	1/2	3-1/2
52-655	1/2	2-1/8	1/2	4-1/2
52-660	5/8	2-1/8	5/8	5
52-664	3/4	3-1/8	3/4	6

HELIX ANGLE ~ 11°

## 52-700



### Double Flute - Solid Carbide Upcut Spiral O Flute

High helix geometry designed to cut soft plastic with a smooth finish and upward chip flow. Special point geometry for improved bottom finish.

**Usage** Soft plastic, extruded acrylic, nylon, ABS, PE, acetal, PET, HDPE, UHMW, polycarbonate, solid surface, foam softwood and hardwood.

**Material** **SP** **SSP** **FP** **SW** **HW**

See Selection Guide - pg. 2 - 12

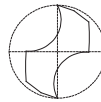

Part Number	Cutting DIA	LoC	SHK DIA	OAL
52-703	1/8	1/2	1/4	2
52-707	1/4	7/8	1/4	3
52-708	3/16	3/8	3/16	2-1/2
52-700	1/4	1-1/4	1/4	3
52-709	3/8	1	3/8	3
52-710	3/16	5/8	1/4	2-1/2
52-701	3/8	1-1/2	3/8	4
52-702	1/2	1-1/4	1/2	4
52-704	1/2	1-3/4	1/2	4
52-706	1/2	2-1/8	1/2	4
52-712	5/8	1-3/4	5/8	5
52-714	5/8	2-1/4	5/8	5
52-726	3/4	1-3/4	3/4	5
52-724	3/4	2-1/2	3/4	5
52-728	3/4	4	3/4	6-1/2
52-734	1	4	1	6-1/2

HELIX ANGLE ~ 22°

#### METRIC (All dimensions in mm)

Part Number	Cutting DIA	LoC	SHK DIA	OAL
52-742	12	35	12	100
52-744	12	45	12	100
52-746	12	55	12	100
52-752	16	45	16	120
52-754	16	55	16	120
52-764	20	65	20	125

## Double Flute - Solid Carbide Upcut Extreme Heavy Duty Standard

Developed for demanding applications where upward chip removal, tool rigidity and long life are essential to success.

**Usage** Natural wood and wood composites

**Material** **SW HW CW**

See Selection Guide - pg. 2 - 12

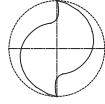

Part Number	Cutting DIA	LoC	SHK DIA	OAL
52-910	1/4	7/8	1/4	2-1/2
52-914	1/4	1-1/4	1/4	3
52-923	3/8	1-1/8	3/8	3
52-936	1/2	1-1/4	1/2	3

HELIX ANGLE ~ 30°

52-900



## Three Flute - Solid Carbide Straight

Designed for routing extremely hard materials or when spindle RPM is lower than normal for routing.

**Usage** Composites

**Material** **CP** See Selection Guide - pg. 2 - 12

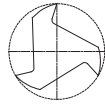

Part Number	Cutting DIA	LoC	SHK DIA	OAL
53-080	1/4	3/4	1/4	2-1/2

53-000



## Three & Four Flute - Solid Carbide Spiral for Glass-Reinforced Plastic (Coated)

Updated line of three and four flute tools for machining glass-reinforced plastic. Geometry has been optimized to shear the glass fibers while creating a chip which removes heat from the cut to avoid melting of the material. Tools are coated to withstand the abrasive characteristics inherent to glass-reinforced plastic (GRP).

**Usage** Fiberglass and Composites

**Material** **CP** See Selection Guide - pg. 2 - 12

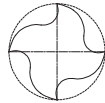

### UPCUT

Part Number	Cutting DIA	LoC	SHK DIA	OAL	FLUTES
54-205	1/8	1/2	1/4	2-1/2	3
54-210	3/16	5/8	1/4	2-1/2	3
54-220	1/4	3/4	1/4	2-1/2	4
54-230	3/8	1-1/8	3/8	3	4
54-240	1/2	1-1/8	1/2	3-1/2	4

### METRIC UPCUT (All dimensions in mm)

Part Number	Cutting DIA	LoC	SHK DIA	OAL	FLUTES
54-260	6	19	6	76	4
54-266	8	22	8	76	4
54-270	10	25	10	76	4
54-276	12	25	12	76	4

### DOWNCUT

Part Number	Cutting DIA	LoC	SHK DIA	OAL	FLUTES
54-206	1/8	1/2	1/4	2-1/2	3
54-211	3/16	5/8	1/4	2-1/2	3
54-221	1/4	3/4	1/4	2-1/2	4
54-231	3/8	1-1/8	3/8	3	4
54-241	1/2	1-1/8	1/2	3-1/2	4

### METRIC DOWNCUT (All dimensions in mm)

Part Number	Cutting DIA	LoC	SHK DIA	OAL	FLUTES
54-261	6	19	6	76	4
54-267	8	22	8	76	4
54-271	10	25	10	76	4
54-277	12	25	12	76	4

54-200



## 56-000

### Double Flute - Solid Carbide Straight

Designed to rout composite plastic.

**Usage** Composite plastic

**Material** **HP** **CP**

See Selection Guide - pg. 2 - 12

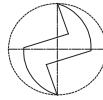

\* These tools are designed and toleranced for air routers with guide bushings.

Part Number	Cutting DIA	LoC	SHK DIA	OAL
56-040	1/8	1/2	1/4	2
56-060	3/16	5/8	1/4	2
56-080	1/4	3/4	1/4	2-1/2
56-084*	1/4	3/4	1/4	3-1/4
56-100	5/16	13/16	3/8	2-1/2
56-160	1/2	1	1/2	3

## 56-000P

### Double Flute - Solid Carbide Straight

Designed specifically to rout harder, more rigid plastics.

**Usage** Foam, fiberglass, phenolic, acrylic, nylon, PVC, ABS, acetal and solid surface

**Material** **HP** **CP** **SSP** **FP**

See Selection Guide - pg. 2 - 12

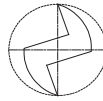

\* These tools are designed and toleranced for air routers with guide bushings.

L = Left Hand Rotation

Part Number	Cutting DIA	LoC	SHK DIA	OAL
56-041	1/8	1/4	1/4	2
56-061	3/16	3/8	1/4	2
56-062	3/16	5/8	1/4	2
56-062L	3/16	5/8	1/4	2
56-063*	3/16	5/8	1/4	4
56-081	1/4	3/8	1/4	2-1/2
56-082	1/4	3/4	1/4	2-1/2
56-082L	1/4	3/4	1/4	2-1/2
56-086*	1/4	1-1/4	1/4	4
56-121	3/8	5/8	3/8	2-1/2
56-122	3/8	7/8	3/8	2-1/2
56-122L	3/8	7/8	3/8	2-1/2
56-124*	3/8	1-5/8	3/8	6
56-162	1/2	1	1/2	3
56-162L	1/2	1	1/2	3
56-164*	1/2	2-1/8	1/2	6

## 56-200

### Double Flute - Solid Carbide Straight Wood Rout

Provides a superior finish in a variety of wood materials and optimum cutter life.

**Usage** Natural wood and wood composites

**Material** **SW** **HW** **CW**

See Selection Guide - pg. 2 - 12

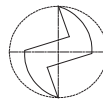

Part Number	Cutting DIA	LoC	SHK DIA	OAL
56-240	1/8	1/2	1/4	2
56-250	5/32	5/8	1/4	2
56-260	3/16	3/4	1/4	2
56-270	7/32	3/4	1/4	2-1/2
56-280	1/4	7/8	1/4	2-1/2
56-285	1/4	1	1/4	2-1/2
56-287	1/4	1-1/8	1/4	3
56-300	5/16	1-1/8	5/16	3
56-310	5/16	1-1/8	1/2	3
56-320	3/8	1-1/8	3/8	3
56-330	3/8	1-1/4	1/2	3
56-360	1/2	1-1/8	1/2	3
56-365	1/2	1-5/8	1/2	3-1/2
56-390	3/4	1-5/8	3/4	4

## Double Flute - Solid Carbide Straight O Flute

Designed with free cutting O flute geometry along with a double flute design for smooth finish.

**Usage** Polycarbonate, ABS, HIPS, HDPE, PET, acrylic, polystyrene, polypropylene, PE, PVC, acetal, UHMW

**Material** **SP** **HP**  
See Selection Guide - pg. 2 - 12

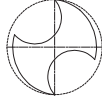

### METRIC (All dimensions in mm)

Part Number	Cutting DIA	LoC	SHK DIA	OAL
56-430	4	16	6	64
56-431	5	20	6	64
56-432	6	25	6	64
56-434	8	25	8	76
56-436	10	35	10	88
56-438	12	35	12	88

56-430



## Double Flute - Solid Carbide Straight

Designed specifically to rout harder, more rigid plastics

**Usage** Phenolic, acrylic, nylon, PVC, ABS, acetal and solid surface

**Material** **HP** **CP** **SSP**  
See Selection Guide - pg. 2 - 12

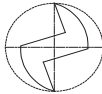

### METRIC (All dimensions in mm)

Part Number	Cutting DIA	LoC	SHK DIA	OAL
56-450	4	16	6	64
56-451	5	20	6	64
56-452	6	25	6	64
56-454	8	25	8	76
56-456	10	35	10	88
56-458	12	35	12	88

56-450



## Double Flute - Solid Carbide O Flute Straight

Designed with free cutting O flute geometry along with a double flute design for smooth finish.

**Usage** Polycarbonate, ABS, HIPS, HDPE, PET, acrylic, polystyrene, polypropylene, PE, PVC, acetal, UHMW

**Material** **SP** **HP**  
See Selection Guide - pg. 2 - 12

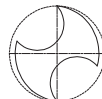

Part Number	Cutting DIA	LoC	SHK DIA	OAL
56-610	1/8	5/16	1/4	2
56-612	1/8	1/2	1/4	2
56-614	1/8	5/8	1/4	4
56-616	3/16	3/8	1/4	2
56-618	3/16	5/8	1/4	2
56-620	3/16	1	1/4	4
56-624	1/4	3/8	1/4	2-1/2
56-625	1/4	1	1/4	2-1/2
56-625L	1/4	1	1/4	2-1/2
56-626	1/4	1	1/4	3-1/4
56-628	1/4	1-1/4	1/4	4
56-638	3/8	7/8	3/8	2-1/2
56-639	3/8	1	3/8	4
56-650	1/2	1	1/2	3
56-652	1/2	1	1/2	4
56-654	1/2	1-3/4	1/2	4
56-655	1/2	2-1/8	1/2	6

L = Left Hand Rotation

56-600



## 57-000



### Double Flute - Solid Carbide Downcut Spiral

Designed as a general purpose spiral with several times the life of their high speed counterparts. They are used when a downward chipflow action is preferred.

**Usage** Aluminum and composite plastic

**Material** **CP** **A**

See Selection Guide - pg. 2 - 12

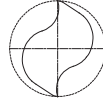

Part Number	Cutting DIA	LoC	SHK DIA	OAL
57-040	1/8	1/2	1/4	2
57-060	3/16	5/8	1/4	2
57-080	1/4	3/4	1/4	2-1/2
57-120	3/8	7/8	3/8	2-1/2
57-160	1/2	1	1/2	3

HELIX ANGLE = 30°

## 57-200



### Double Flute - Solid Carbide Downcut Spiral Wood Rout

Designed for routing where downward chip removal, tool rigidity, long life, and high quality finish is desired.

**Usage** Natural wood and wood composites

**Material** **SW** **HW** **CW**

See Selection Guide - pg. 2 - 12

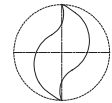

Part Number	Cutting DIA	LoC	SHK DIA	OAL
57-244	1/8	1/2	1/8	2
57-240	1/8	1/2	1/4	2
57-240L	1/8	1/2	1/4	2
57-251	5/32	1/2	1/4	2-1/2
57-250	5/32	5/8	1/4	2
57-260	3/16	3/4	1/4	2
57-261	3/16	3/4	1/4	2-1/2
57-270	7/32	3/4	1/4	2-1/2
57-280	1/4	7/8	1/4	2-1/2
57-285	1/4	1	1/4	2-1/2
57-285L	1/4	1	1/4	2-1/2
57-287	1/4	1-1/8	1/4	3
57-290	9/32	1	5/16	2-1/2
57-300	5/16	1-1/8	5/16	3
57-310	5/16	1-1/8	1/2	3
57-310L	5/16	1-1/8	1/2	3
57-318*	3/8	1	3/8	3

Part Number	Cutting DIA	LoC	SHK DIA	OAL
57-320	3/8	1-1/8	3/8	3
57-325	3/8	1-1/4	3/8	3
57-330	3/8	1-1/4	1/2	3
57-340	7/16	1	1/2	3
57-360	1/2	1-1/8	1/2	3
57-362	1/2	1-1/4	1/2	3-1/2
57-365	1/2	1-5/8	1/2	3-1/2
57-365L	1/2	1-5/8	1/2	3-1/2
57-367	1/2	2-1/8	1/2	4
57-370	17/32	1-1/8	1/2	3
57-380	5/8	1-5/8	5/8	3-1/2
57-385	5/8	2-1/8	5/8	4
57-390	3/4	1-5/8	3/4	4
57-395	3/4	2-1/8	3/4	5
57-395L	3/4	2-1/8	3/4	5

HELIX ANGLE = 30°

L = Left Hand Rotation

\* Special Point (Improved Bottom Finish)

## 57-200MD



### Double Flute - Marathon Wood Rout Downcut (Coated)

The longest running downcut in the industry due to advancements in geometry and the addition of a unique Onsrud coating.

**Usage** Natural wood and wood composites

**Material** **SW** **HW** **CW** **LW**

See Selection Guide - pg. 2 - 12

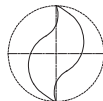

Part Number	Cutting DIA	LoC	SHK DIA	OAL
57-278MD	1/4	3/8	1/4	2-1/2
57-279MD	1/4	5/8	1/4	2-1/2
57-317MD	3/8	7/8	3/8	3
57-359MD	1/2	7/8	1/2	3

## Double Flute - Solid Carbide Downtcut Spiral Wood Rout

Designed for routing where downward chip removal, tool rigidity, long life, and high quality finish is desired.

**Usage** Natural wood and wood composites

**Material** **SW HW CW**

See Selection Guide - pg. 2 - 12

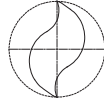

### METRIC (All dimensions in mm)

Part Number	Cutting DIA	LoC	SHK DIA	OAL
57-410	4	16	6	64
57-411	5	20	6	64
57-412	6	25	6	64
57-414	8	25	8	64
57-416	10	35	10	76

HELIX ANGLE ≈ 30°

57-400



## Double Flute - Solid Carbide Downtcut Spiral O Flute

Designed to cut plastic with a smooth finish and downward chip flow.

**Usage** Acrylic, nylon, ABS, PE, acetal, PET, HDPE, UHMW, polycarbonate and solid surface

**Material** **SP HP SSP**

See Selection Guide - pg. 2 - 12

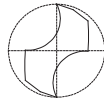

Part Number	Cutting DIA	LoC	SHK DIA	OAL
57-623	1/4	3/8	1/4	2-1/2
57-625	1/4	3/4	1/4	2-1/2
57-637	3/8	1	3/8	3
57-651	1/2	1-1/8	1/2	3-1/2

HELIX ANGLE ≈ 10-11°

### METRIC (All dimensions in mm)

Part Number	Cutting DIA	Flute LGTH	SHK DIA	OAL
57-627	6	25	6	64
57-639	8	25	8	76

57-600



## Double Flute - Solid Carbide Downtcut Extreme Heavy Duty Standard

Designed for routing where extreme loads are placed upon the cutting tools and when extra part hold down is required.

**Usage** Natural wood and wood composites

**Material** **SW HW CW**

See Selection Guide - pg. 2 - 12

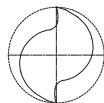

Part Number	Cutting DIA	LoC	SHK DIA	OAL
57-910	1/4	7/8	1/4	2-1/2
57-921	3/8	7/8	3/8	3
57-923	3/8	1-1/8	3/8	3
57-924	3/8	1-1/4	3/8	3
57-936	1/2	1-1/4	1/2	3
57-940	1/2	1-5/8	1/2	3-1/2

HELIX ANGLE ≈ 30°

57-900



## 60-000



### Three Flute - Solid Carbide High Helix Hogger

Designed with unique scalloped cutting edge design for extremely fast machining and roughing. Faster chip removal with upcuts. Better hold down with downcuts.

**Usage** Natural wood & wood composites, hard & soft plastic and plastic composites

**Material** **SW HW CW SP HP**  
See Selection Guide - pg. 2 - 12

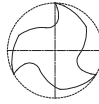

#### UPCUT

Part Number	Cutting DIA	LoC	SHK DIA	OAL
60-001	3/8	1-1/8	3/8	3-1/2
60-005	1/2	1-1/8	1/2	3-1/2
60-007	1/2	1-5/8	1/2	4
60-011	5/8	2-1/8	5/8	5
60-017	3/4	1-5/8	3/4	4
60-019	3/4	2-1/8	3/4	5

HELIX ANGLE ≈ 30°

#### DOWNCUT

Part Number	Cutting DIA	LoC	SHK DIA	OAL
60-002	3/8	1-1/8	3/8	3-1/2
60-006	1/2	1-1/8	1/2	3-1/2
60-008	1/2	1-5/8	1/2	4
60-012	5/8	2-1/8	5/8	5
60-018	3/4	1-5/8	3/4	4
60-020	3/4	2-1/8	3/4	5

## 60-000



### Three Flute - Solid Carbide Low Helix Hogger

Designed with unique scalloped cutting geometry which provides extremely fast roughing, lower horsepower requirements, longer tool life, and reduced chipping in solid wood materials.

**Usage** Natural wood & wood composites, hard & soft plastic and plastic composites

**Material** **SW HW CW SP HP**  
See Selection Guide - pg. 2 - 12

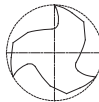

#### UPCUT

Part Number	Cutting DIA	LoC	SHK DIA	OAL
60-037	3/8	1-1/8	3/8	3-1/2
60-053	1/2	1-1/8	1/2	3-1/2
60-051	1/2	1-5/8	1/2	4
60-061	5/8	2-1/8	5/8	5
60-073	3/4	1-5/8	3/4	4
60-071	3/4	2-1/8	3/4	5

HELIX ANGLE ≈ 10°

#### DOWNCUT

Part Number	Cutting DIA	LoC	SHK DIA	OAL
60-038	3/8	1-1/8	3/8	3-1/2
60-054	1/2	1-1/8	1/2	3-1/2
60-052	1/2	1-5/8	1/2	4
60-074	3/4	1-5/8	3/4	5
60-072	3/4	2-1/8	3/4	5



## Three Flute - Solid Carbide Upcut Lock Mortise

The scalloped upcut cutting edge design and extra spinback provide fast material removal in deep cuts for horizontal and vertical lock mortise routing.

**Usage** Natural wood and wood composites

**Material** **SW HW CW MT**  
See Selection Guide - pg. 2 - 12

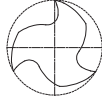

Part Number	Cutting DIA	LoC	Max DOC	SHK DIA	OAL
60-090	5/8	2	4-1/2	5/8	6-1/2

HELIX ANGLE ≈ 30°

### METRIC (All dimensions in mm)

Part Number	Cutting DIA	LoC	Max DOC	SHK DIA	OAL
60-091	16	50	114	16	170

HELIX ANGLE ≈ 30°

60-090



## Double & Three Flute - Marathon Compression Spiral (Coated)

The LMT Onsrud Marathon is the longest running compression tool due to advancements in cutting geometry and the addition of a unique Onsrud coating. The coating is formulated to protect the cutting edge from the high temperatures generated when routing laminated and composite wood products.

**Usage** Double-sided laminated and Veneered Wood Composites

**Material** **CW SW HW LW MT**  
See Selection Guide - pg. 2 - 12

### TWO FLUTE

Part Number	Cutting DIA	LoC	Upcut LoC	SHK DIA	OAL
60-123MC*	3/8	7/8	.200	3/8	3
60-124MC	3/8	1-1/8	.406	3/8	3
60-163MC*	1/2	7/8	.200	1/2	3
60-169MC	1/2	1-1/8	.562	1/2	3
60-171MC	1/2	1-3/8	.625	1/2	3-1/2
60-173MC*	1/2	1-3/8	.200	1/2	3-1/2
60-172MC	1/2	1-5/8	.750	1/2	4

\* MORTISE COMPRESSION

### THREE FLUTE

Part Number	Cutting DIA	LoC	Upcut LoC	SHK DIA	OAL
60-126MC*	3/8	7/8	.200	3/8	3
60-177MC*	1/2	1-3/8	.200	1/2	3-1/2

\* MORTISE COMPRESSION

### METRIC (All dimensions in mm)

Part Number	Cutting DIA	LoC	Upcut LoC	SHK DIA	OAL	# of Flutes
60-152MC	6	22	4	6	64	1
60-153MC	8	22	4	8	64	2
60-155MC	10	22	4	10	76	2
60-156MC	12	28	6	12	76	2

60-100MC

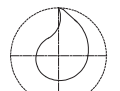

Single Flute

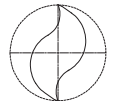

Double Flute

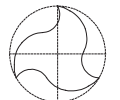

Three Flute

## 60-100PLR



**NEW**

## Double Flute - Polaris Compression Spiral

The Polaris Compression Series is the latest advancement in technology and design by LMT Onsrud, the innovator of compression spiral tooling. The enhanced tooling geometry improves cut quality while achieving maximum productivity. Superior coating adhesion and performance is achieved through a precoating process that ensures the durability of the advanced coating and your cutting edge for maximum tool life. Learn more at [Onsrud.com/Polaris](http://Onsrud.com/Polaris).

**Usage** High pressure laminates, double-sided laminates and veneered wood composites

**Material** **CW SW HW LW MT**

See Selection Guide - pg. 2 - 12

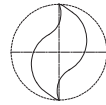

Double Flute

Part Number	Cutting DIA	LoC	Upcut LoC	SHK DIA	OAL
60-123PLR*	3/8	7/8	0.188	3/8	3
60-163PLR*	1/2	7/8	0.200	1/2	3
60-169PLR	1/2	1-1/8	0.562	1/2	3

\* MORTISE COMPRESSION



## 60-100MW



## Single, Double & Three Flute - Solid Carbide *Max Life* Compression Spiral

Designed for maximum life when cutting in high-wear applications. Unique geometries and carbides improve the wear characteristics of the tool under abrasive applications with superior part finish. Mortise compressions are designed with short upcut to allow mortise cut with downcut action.

**Usage** Double sided laminated and veneered materials

**Material** **CW SW HW LW MT**

See Selection Guide - pg. 2 - 12

### DOUBLE FLUTE

Part Number	Cutting DIA	LoC	Upcut LoC	SHK DIA	OAL
60-113MW*	1/4	7/8	.188	1/4	2-1/2
60-123MW*	3/8	7/8	.188	3/8	3
60-124MW	3/8	1-1/8	.406	3/8	3
60-127MW*	3/8	1-1/8	.188	3/8	3
60-163MW*	1/2	7/8	.200	1/2	3
60-169MW	1/2	1-1/8	.562	1/2	3
60-171MW	1/2	1-3/8	.625	1/2	3-1/2
60-172MW	1/2	1-5/8	.750	1/2	4
60-173MW*	1/2	1-3/8	.200	1/2	3-1/2
60-181MW	1/2	2-1/8	1	1/2	5
60-186MW	5/8	2-1/4	1	5/8	5
60-196MW	3/4	1-7/8	.750	3/4	4
60-194MW	3/4	2-1/4	1	3/4	5

HELIX ANGLE ≈ 30°

\*MORTISE COMPRESSION

### SINGLE FLUTE

Part Number	Cutting DIA	LoC	Upcut LoC	SHK DIA	OAL
60-102MW	1/8	3/8	.205	1/4	2-1/2
60-106MW	3/16	5/8	.300	1/4	2-1/2
60-111MW*	1/4	7/8	.175	1/4	2-1/2
60-120MW*	3/8	1-1/8	.200	3/8	3
60-167MW*	1/2	1-1/8	.200	1/2	3

HELIX ANGLE ≈ 30°

\*MORTISE COMPRESSION

### THREE FLUTE

Part Number	Cutting DIA	LoC	Upcut LoC	SHK DIA	OAL
60-125MW	3/8	1-1/8	.500	3/8	3
60-126MW*	3/8	7/8	.200	3/8	3
60-176MW*	1/2	7/8	.200	1/2	3
60-177MW*	1/2	1-3/8	.200	1/2	3-1/2

\*MORTISE COMPRESSION

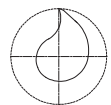

Single Flute

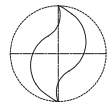

Double Flute

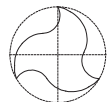

Three Flute

### METRIC (All dimensions in mm)

Part Number	Cutting DIA	LoC	Upcut LoC	SHK DIA	OAL	# of Flutes
60-152MW	6	22	4	6	64	1
60-153MW	8	22	4	8	64	2
60-155MW	10	22	4	10	76	2
60-156MW	12	28	6	12	76	2

## Double Flute - Solid Carbide Compression Spiral

The Tuff Core is an innovative line of solid carbide compression spirals that utilize unique dual grade carbide. The harder outer shell is reinforced by a tough inner core which makes the tool stronger and reduces tool breakage.

**Usage** Double sided laminated, and veneered materials

**Material** **CW SW HW LW MT**

See Selection Guide - pg. 2 - 12

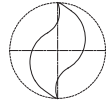

Double Flute

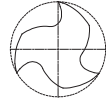

Three Flute

### DOUBLE FLUTE

Part Number	Cutting DIA	LoC	Upcut LoC	SHK DIA	OAL
60-123DC*	3/8	7/8	.188	3/8	3
60-124DC	3/8	1-1/8	.406	3/8	3

### THREE FLUTE

Part Number	Cutting DIA	Flute LGTH	Upcut Flute LGTH	SHK DIA	OAL
60-126DC*	3/8	7/8	.200	3/8	3

\* MORTISE COMPRESSION

60-100DC



## Double Flute - Solid Carbide Chipbreaker/Finisher Compression Spiral

Designed to give the optimum edge finish of the compression spiral bits along with the increased feed rates of the chipbreaker/finisher design.

**Usage** Double sided laminated, veneered, natural wood and wood composites

**Material** **CW SW HW LW MT**

See Selection Guide - pg. 2 - 12

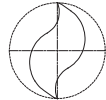

Part Number	Cutting DIA	LoC	Upcut LoC	SHK DIA	OAL
60-123C*	3/8	7/8	.188	3/8	3
60-124C	3/8	1-1/8	.406	3/8	3
60-163C*	1/2	7/8	.200	1/2	3
60-169C	1/2	1-1/8	.562	1/2	3
60-172C	1/2	1-5/8	.750	1/2	4

HELIX ANGLE ≈ 30°

\* MORTISE COMPRESSION

60-100C



## 60-200



### Three Flute - Solid Carbide Low Helix Finisher

Designed for perfect balance and ultra smooth finish over a wide speed range.

**Usage** Natural wood, plastic, composite plastic and solid surface

**Material** SW HW CW HP SSP  
See Selection Guide - pg. 2 - 12

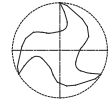

#### UPCUT

Part Number	Cutting DIA	LoC	SHK DIA	OAL
60-239	1/4	3/8	1/4	3
60-241	1/4	7/8	1/4	3
60-243	3/8	5/8	3/8	3
60-245	3/8	1-1/8	3/8	3
60-249	1/2	1-1/8	1/2	3-1/2
60-253	1/2	1-5/8	1/2	4
60-251	1/2	2-1/8	1/2	4-1/2
60-269	3/4	1-5/8	3/4	4
60-271	3/4	2-1/8	3/4	5
60-277	3/4	3-1/8	3/4	6

HELIX ANGLE ≈ 10°

#### DOWNCUT

Part Number	Cutting DIA	LoC	SHK DIA	OAL
60-240	1/4	3/8	1/4	3
60-242	1/4	7/8	1/4	3
60-244	3/8	5/8	3/8	3
60-246	3/8	1-1/8	3/8	3
60-250	1/2	1-1/8	1/2	3-1/2
60-254	1/2	1-5/8	1/2	4
60-252	1/2	2-1/8	1/2	4-1/2
60-270	3/4	1-5/8	3/4	5
60-272	3/4	2-1/8	3/4	5
60-278	3/4	3-1/8	3/4	6

HELIX ANGLE ≈ 10°

#### UPCUT METRIC (All dimensions in mm)

Part Number	Cutting DIA	LoC	SHK DIA	OAL
60-471	8	25	8	76
60-473	10	35	10	76
60-475	12	35	12	88

HELIX ANGLE ≈ 10°

## 60-300



### Double Flute - Solid Carbide Chipbreaker Finisher

For faster feed rates than a conventional two flute with a smooth finish.

**Usage** Natural wood and wood composites

**Material** HW CW SW  
See Selection Guide - pg. 2 - 12

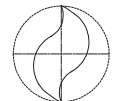

#### UPCUT

Part Number	Cutting DIA	LoC	SHK DIA	OAL
60-307	3/8	1-1/8	3/8	3
60-311	1/2	1-1/8	1/2	3
60-313	1/2	1-5/8	1/2	3-1/2
60-317	1/2	1-7/8	1/2	3-1/2
60-315	1/2	2-1/8	1/2	4
60-321	5/8	2-1/8	5/8	4
60-325	3/4	2-1/8	3/4	4

HELIX ANGLE ≈ 30°

#### DOWNCUT

Part Number	Cutting DIA	LoC	SHK DIA	OAL
60-308	3/8	1-1/8	3/8	3
60-312	1/2	1-1/8	1/2	3
60-314	1/2	1-5/8	1/2	3-1/2
60-318	1/2	1-7/8	1/2	3-1/2
60-316	1/2	2-1/8	1/2	4
60-322	5/8	2-1/8	5/8	4
60-326	3/4	2-1/8	3/4	4

**60-350**

### Three Flute - Solid Carbide Chipbreaker Finisher

For additional balance at fast feed rates with a smooth finish.

**Usage** Natural wood and wood composites

**Material** SW HW CW

See Selection Guide - pg. 2 - 12

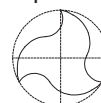

**UPCUT**

Part Number	Cutting DIA	LoC	SHK DIA	OAL
60-337	3/8	1-1/8	3/8	3
60-351	1/2	1-1/8	1/2	3
60-353	1/2	1-5/8	1/2	3-1/2
60-361	5/8	1-5/8	5/8	4
60-371	3/4	1-5/8	3/4	4
60-375	3/4	3-1/8	3/4	6

HELIX ANGLE ≈ 30°

**DOWNCUT**

Part Number	Cutting DIA	LoC	SHK DIA	OAL
60-338	3/8	1-1/8	3/8	3
60-350	1/2	1-1/8	1/2	3
60-354	1/2	1-3/8	1/2	3-1/2
60-352	1/2	1-5/8	1/2	3-1/2
60-360	5/8	1-5/8	5/8	4
60-370	3/4	1-5/8	3/4	4
60-372	3/4	2-1/4	3/4	5
60-374	3/4	3-1/8	3/4	6

### Four Flute - Solid Carbide High Velocity Compression Spiral

Combine a roughing and finishing cut in one tool for rapid feed rates with a good finish.

**Usage** High velocity routing of double sided laminated and veneered, natural wood and wood composites

**Material** SW HW CW LW

See Selection Guide - pg. 2 - 12

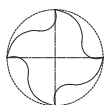

Part Number	Cutting DIA	LoC	Upcut LoC	SHK DIA	OAL
60-669	1/2	1-1/8	.500	1/2	3
60-671	1/2	1-3/8	.500	1/2	3-1/2

HELIX ANGLE ≈ 30°

**60-600**



### Four Flute - Solid Carbide High Velocity Spiral

Combine a roughing and finishing cut with upcut cutting action in one tool for rapid feed rates with a good finish.

**Usage** High velocity routing of double sided laminated and veneered, natural wood and wood composites

**Material** SW HW CW

See Selection Guide - pg. 2 - 12

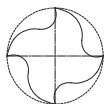

**UPCUT**

Part Number	Cutting DIA	LoC	SHK DIA	OAL
60-711	1/2	1-1/8	1/2	3-1/2
60-715	1/2	1-5/8	1/2	4
60-719	1/2	2-1/8	1/2	4-1/2
60-731	3/4	2-1/8	3/4	5

HELIX ANGLE ≈ 30°

**DOWNCUT**

Part Number	Cutting DIA	LoC	SHK DIA	OAL
60-710	1/2	1-1/8	1/2	3-1/2
60-714	1/2	1-5/8	1/2	4
60-718	1/2	2-1/8	1/2	4-1/2
60-720	5/8	2-1/8	5/8	5

HELIX ANGLE ≈ 30°

**60-700**



## 60-800



### Double Flute - Solid Carbide Rougher

Designed for use when faster feed rates cannot be achieved, or on low horsepower machines.

**Usage**

Natural wood and wood composites

**Material**



See Selection Guide - pg. 2 - 12

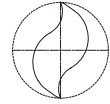

#### UPCUT

Part Number	Cutting DIA	LoC	SHK DIA	OAL
60-815	3/8	1-3/8	3/8	3-1/2
60-825	1/2	1-3/8	1/2	3-1/2
60-829	1/2	1-7/8	1/2	4
60-841	5/8	2-5/8	5/8	5
60-847	3/4	2-7/8	3/4	6

#### DOWNCUT

Part Number	Cutting DIA	LoC	SHK DIA	OAL
60-816	3/8	1-3/8	3/8	3-1/2
60-826	1/2	1-3/8	1/2	3-1/2
60-830	1/2	1-7/8	1/2	4
60-842	5/8	2-5/8	5/8	5
60-848	3/4	2-7/8	3/4	6

HELIX ANGLE ~ 20°

## 60-900



### Three Flute - Solid Carbide Extreme Heavy Duty Hogger

Designed for heavy material removal operations where the cutter is subject to excessive cutting forces and finish is not a primary concern.

**Usage**

Natural wood and wood composites, plastic composites

**Material**



See Selection Guide - pg. 2 - 12

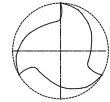

#### UPCUT

Part Number	Cutting DIA	LoC	SHK DIA	OAL
60-901	3/8	1-1/8	3/8	3
60-905	1/2	1-1/8	1/2	3
60-907	1/2	1-5/8	1/2	3-1/2
60-909	1/2	2-1/8	1/2	4
60-915	3/4	2-1/8	3/4	5

#### DOWNCUT

Part Number	Cutting DIA	LoC	SHK DIA	OAL
60-902	3/8	1-1/8	3/8	3
60-906	1/2	1-1/8	1/2	3
60-908	1/2	1-5/8	1/2	3-1/2
60-910	1/2	2-1/8	1/2	4
60-916	3/4	2-1/8	3/4	5

HELIX ANGLE ~ 30°

## 60-950



### Double Flute - Solid Carbide Extreme Heavy Duty Chipbreaker/Finisher

Designed to be fed very fast while withstanding excessive cutting forces and at the same time leaving a smooth finish.

**Usage**

Natural wood and wood composites

**Material**



See Selection Guide - pg. 2 - 12

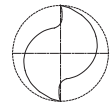

#### UPCUT

Part Number	Cutting DIA	LoC	SHK DIA	OAL
60-951	3/8	1-1/8	3/8	3
60-955	1/2	1-1/8	1/2	3
60-957	1/2	1-5/8	1/2	3-1/2
60-959	1/2	2-1/8	1/2	4
60-965	3/4	2-1/8	3/4	5

#### DOWNCUT

Part Number	Cutting DIA	LoC	SHK DIA	OAL
60-950	3/8	1-1/8	3/8	3
60-954	1/2	1-1/8	1/2	3
60-956	1/2	1-5/8	1/2	3-1/2
60-958	1/2	2-1/8	1/2	4

HELIX ANGLE ~ 30°

## Single Flute - Solid Carbide Straight

Designed to combine the fast free cutting of O flute geometry with the tool life available from solid carbide particularly in small diameters.

**Usage** Natural wood and aluminum

**Material** **SW** **A**

See Selection Guide - pg. 2 - 12

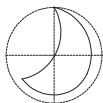

Part Number	Cutting DIA	LoC	SHK DIA	OAL
61-040	1/8	1/2	1/4	2
61-050	5/32	9/16	1/4	2
61-060	3/16	5/8	1/4	2
61-070	7/32	5/8	1/4	2-1/2
61-080	1/4	3/4	1/4	2-1/2
61-090	9/32	3/4	3/8	2-1/2
61-100	5/16	13/16	3/8	2-1/2
61-120	3/8	7/8	3/8	2-1/2
61-140	7/16	1	1/2	3
61-160	1/2	1	1/2	3



## Single Flute - Solid Carbide Straight

Designed to combine the fast free cutting of O flute geometry with the tool life available from solid carbide particularly in small diameters.

**Usage** Polycarbonate, polyethylene, polypropylene, polystyrene, PVC, extruded acrylic, HDPE, UHMW and hard plastic

**Material** **SP** **HP**

See Selection Guide - pg. 2 - 12

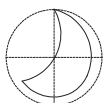

Part Number	Cutting DIA	LoC	SHK DIA	OAL
61-041	1/8	5/16	1/4	2
61-044	1/8	1/2	1/8	2
61-042	1/8	1/2	1/4	2
61-042L	1/8	1/2	1/4	2
61-045	1/8	5/8	1/8	3
61-043	1/8	5/8	1/4	4
61-052	5/32	9/16	1/4	2
61-061	3/16	3/8	1/4	2
61-064	3/16	5/8	3/16	2-1/2
61-062	3/16	5/8	1/4	2
61-062L	3/16	5/8	1/4	2
61-063*	3/16	1	1/4	4
61-072	7/32	5/8	1/4	2-1/2
61-081	1/4	3/8	1/4	2-1/2
61-082	1/4	3/4	1/4	2-1/2
61-082L	1/4	3/4	1/4	2-1/2
61-083*	1/4	3/4	1/4	3-1/4
61-083L*	1/4	3/4	1/4	3-1/4
61-085*	1/4	1	1/4	3-1/4
61-084*	1/4	1-1/4	1/4	4
61-121	3/8	5/8	3/8	2-1/2
61-122	3/8	7/8	3/8	2-1/2
61-123*	3/8	1-5/8	3/8	6
61-162	1/2	1	1/2	3
61-164	1/2	1-5/8	1/2	4
61-166	1/2	2-1/8	1/2	6

\*These tools are designed and toleranced for air routers with guide bushings.  
L= left hand rotation



## 61-200



### Single Flute - Solid Carbide Straight Wood Rout

Designed to enhance operations where the benefits of spiral action are not needed. The single flute provides fast, free cutting with optimum cutter life.

**Usage** Natural wood and wood composites

**Material** **SW HW CW**

See Selection Guide - pg. 2 - 12

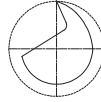

Part Number	Cutting DIA	LoC	SHK DIA	OAL
61-240	1/8	1/2	1/4	2
61-280	1/4	7/8	1/4	2-1/2
61-285	1/4	1	1/4	2-1/2
61-320	3/8	1-1/8	3/8	3

## 61-400



### Single Flute - Solid Carbide Straight

Designed to combine the fast free cutting of O flute geometry with the tool life available from solid carbide particularly in small diameters.

**Usage** Polycarbonate, polyethylene, polypropylene, polystyrene, PVC, extruded acrylic, HDPE, UHMW and hard plastic

**Material** **SP HP**

See Selection Guide - pg. 2 - 12

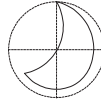

**METRIC (All dimensions in mm)**

Part Number	Cutting DIA	LoC	SHK DIA	OAL
61-410	4	16	6	64
61-411	5	20	6	64
61-412	6	25	6	64
61-414	8	25	8	64
61-418	12	35	12	88

## 62-600



### Single Flute - Solid Carbide Downcut Spiral O Flute

High speed cutters for machining aluminum sheet material. These tools are optimized for use on high-speed CNC mills, high speed machining centers and CNC routers.

**Usage** Aluminum, plate, single & multi sheet

**Material** **A** See Selection Guide - pg. 2 - 12

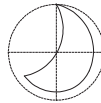

Part Number	Cutting DIA	LoC	SHK DIA	OAL
62-602	1/16	1/4	1/8	1-1/2
62-604	1/8	1/4	1/8	1-1/2
62-606	1/8	1/4	1/4	2
62-610	1/8	1/2	1/4	2
62-614	3/16	3/8	1/4	2
62-620	1/4	3/8	1/4	2
62-622	1/4	3/4	1/4	2-1/2
62-624	1/4	1-1/4	1/4	3
62-630	5/16	3/4	1/2	3
62-625	3/8	3/4	3/8	3
62-631	1/2	1-1/8	1/2	3-1/2

HELIX ANGLE ≈ 22°



## Single Flute - Solid Carbide Downcut Spiral O Flute

(HP) Designed to provide a smooth finish in hard plastics with downward chip removal.

(SP) Designed to provide provide a smooth finish in soft plastic with downward chip removal.

**Usage** (HP): Acrylic, nylon, PVC, polycarbonate and solid surface  
 (SP): HDPE, HIPS, UHMW, ABS, polycarbonate, PE, polystyrene, polypropylene, acetal, acrylic, PET and solid surface

**Material** 62-700 62-750 62-800 62-850

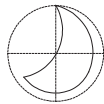

HARD PLASTIC		SOFT PLASTIC			
Part Number	Part Number	Cutting DIA	LoC	SHK DIA	OAL
62-713*	62-763*	1/8	1/2	1/8	2
62-712*	62-762*	1/8	1/2	1/4	2
62-715*		5/32	9/16	1/4	2
62-719*	62-769*	3/16	5/8	3/16	2
62-718	62-768	3/16	5/8	1/4	2
62-725	62-775	1/4	3/4	1/4	2-1/2
62-726	62-776	1/4	1-1/4	1/4	3
62-727*		1/4	1-1/2	1/4	3
62-733	62-783	3/8	1-1/8	3/8	3
62-740	62-790	1/2	1-5/8	1/2	3-1/2

\* Tool balanced by design to run at spindle speeds up to 60,000 RPM

HARD PLASTIC		SOFT PLASTIC		METRIC (All dimensions in mm)	
Part Number	Part Number	Cutting DIA	LoC	SHK DIA	OAL
62-816*	62-866*	3	12	6	64
62-824*	62-874*	4	20	6	64
62-830	62-880	5	16	6	64
62-840		6	30	6	76
62-842*		6	38	6	76
62-844		8	25	8	64
62-846	62-896	8	38	8	76

HELIX ANGLE ≈ 21°

\* Tool balanced by design to run at spindle speeds up to 60,000 RPM

62-700  
62-750  
62-800  
62-850



## Single Flute - Solid Carbide Upcut Spiral

Designed for routing where upward chip removal, tool rigidity, long life, and high quality finish is desired.

**Usage** Fiberglass, phenolic and aluminum

**Material** See Selection Guide - pg. 2 - 12

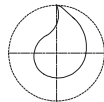

Part Number	Cutting DIA	LoC	SHK DIA	OAL
63-040	1/8	1/2	1/4	2
63-050	5/32	9/16	1/4	2
63-060	3/16	5/8	1/4	2
63-080	1/4	3/4	1/4	2-1/2
63-100	5/16	13/16	3/8	2-1/2
63-160	1/2	1	1/2	3

HELIX ANGLE ≈ 30°

63-000



## 63-200



### Single Flute - Solid Carbide Upcut Spiral Wood Rout

Designed for routing where aggressive upward chip removal is necessary in hand-fed or CNC applications. Tool rigidity, long life, and high quality finish are characteristic of these tools.

**Usage** Natural wood and wood composites

**Material** **SW HW CW**

See Selection Guide - pg. 2 - 12

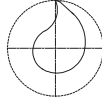

Part Number	Cutting DIA	LoC	SHK DIA	OAL
63-240	1/8	1/2	1/4	2
63-280	1/4	7/8	1/4	2-1/2

HELIX ANGLE ≈ 30°

## 63-400



### Single Flute - Solid Carbide Upcut for Soft Aluminum (Coated)

These tools are specially designed to cut soft grades of aluminum and create a good edge finish. The improved cutting geometry properly forms and evacuates the chips preventing chip rewelding.

**Usage** Soft aluminum sheet, 3003 grade aluminum

**Material** **A**

See Selection Guide - pg. 2 - 12

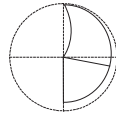

Part Number	Cutting DIA	LoC	SHK DIA	OAL	COATING
63-420	3/16	1/4	1/4	2	ZRN
63-430	1/4	1/4	1/4	2	ZRN

#### METRIC (All dimensions in mm)

Part Number	Cutting DIA	LoC	SHK DIA	OAL	COATING
63-450	5	6	6	64	ZRN
63-460	6	6	6	64	ZRN

#### CUTTING PARAMETERS

Part Number	RPM	Feed Rate
63-420	13,250	100 IPM
63-430	10,000	80 IPM
63-450	13,250	100 IPM
63-460	10,000	80 IPM

## Single Flute - Solid Carbide Upcut Spiral O Flute for Acrylic

These tools are designed to cut acrylics and achieve long tool life. Our unique cutting geometry produces a smooth edge finish regardless if it is cast or extruded acrylic.

**Usage** Acrylic

**Material** **SP** **HP**

See Selection Guide - pg. 2 - 12

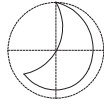

Part Number	Cutting DIA	LoC	SHK DIA	OAL
63-505*	1/16	1/4	1/4	2
63-510	1/8	1/4	1/4	2
63-515*	1/8	1/2	1/4	2
63-520*	3/16	5/8	1/4	2
63-525	1/4	3/8	1/4	2-1/2
63-530	1/4	3/4	1/4	2-1/2
63-535	3/8	1-1/8	3/8	3

\*Tool balanced by design to run at spindle speeds up to 60,000 RPM

63-500



## Single Flute - Solid Carbide Upcut Spiral O Flute

High speed cutters for machining aluminum sheet and block material. These tools are optimized for use on high-speed CNC mills, high speed machining centers and CNC routers.

**Usage** Aluminum plate and single/multi sheet aluminum, ACM

**Material** **A**

See Selection Guide - pg. 2 - 12

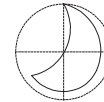

Part Number	Cutting DIA	LoC	SHK DIA	OAL
63-602	1/16	1/4	1/8	1-1/2
63-603	3/32	1/4	1/8	2
63-604	1/8	1/4	1/8	1-1/2
63-606	1/8	1/4	1/4	2
63-610	1/8	1/2	1/4	2
63-611	5/32	5/16	3/16	2
63-612	3/16	3/8	3/16	1-1/2
63-614	3/16	3/8	1/4	2
63-618	3/16	5/8	1/4	2
63-620	1/4	3/8	1/4	2

Part Number	Cutting DIA	LoC	SHK DIA	OAL
63-622	1/4	3/4	1/4	2-1/2
63-624	1/4	1-1/4	1/4	3
63-629	5/16	9/16	5/16	2-1/2
63-630	5/16	3/4	1/2	3
63-634	21/64	3/4	1/2	3
63-625	3/8	3/4	3/8	3
63-626	3/8	1-1/8	3/8	3
63-627	3/8	1-3/8	3/8	3-1/2
63-631	1/2	1-1/8	1/2	3-1/2
63-632	1/2	1-3/8	1/2	3-1/2

HELIX ANGLE ~ 22°

63-600



63-700  
63-750  
63-800  
63-850



## Single Flute - Solid Carbide Upcut Spiral O Flute

(HP) Designed to provide a smooth finish in hard plastics with upward chip removal.

(SP) Designed to provide a smooth finish in soft plastic with upward chip removal.

**Usage (HP):** Acrylic, nylon, PVC, polycarbonate and solid surface

**(SP):** HDPE, HIPS, UHMW, ABS, polycarbonate, PE, polystyrene, polypropylene, acetal, acrylic, PET and solid surface

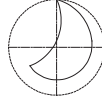

**Material** 63-700 **HP SSP** 63-750 **SP HP SSP**  
63-800 **HP SSP** 63-850 **SP HP SSP**

HARD PLASTIC		SOFT PLASTIC		METRIC (All dimensions in mm)							
Part Number	Part Number	Cutting DIA	LoC	SHK DIA	OAL	Part Number	Part Number	Cutting DIA	LoC	SHK DIA	OAL
63-701*	63-751*	1/16	1/4	1/8	2	63-802		2	8	2	50
63-700*	63-750*	1/16	1/4	1/4	2	63-804*	63-854*	2	8	6	64
63-706*		1/8	5/8	1/4	2-1/2	63-806		2.5	8	2.5	50
63-707*		1/8	3/4	1/4	2-1/2	63-808*		2.5	8	6	64
63-711*	63-761*	1/8	1/4	1/8	2	63-810*	63-860*	3	8	3	50
63-710*	63-760*	1/8	1/4	1/4	2	63-812*	63-862*	3	8	6	64
63-713*	63-763*	1/8	1/2	1/8	2	63-814*	63-864*	3	12	3	64
63-712*	63-762*	1/8	1/2	1/4	2	63-816*	63-866*	3	12	6	64
63-743 <sup>2</sup>	63-793 <sup>2</sup>	1/8	1/2	1/4	2	63-818*		4	8	4	64
63-715*		5/32	9/16	1/4	2	63-820*	63-870*	4	12	4	64
63-716*	63-766*	3/16	3/8	3/16	2	63-822*		4	20	4	64
63-717*	63-767*	3/16	3/8	1/4	2	63-824*	63-874*	4	20	6	64
63-719*	63-769*	3/16	5/8	3/16	2	63-826*		4	30	4	64
63-718*	63-768*	3/16	5/8	1/4	2	63-828	63-878*	5	16	5	64
63-720		7/32	3/4	1/4	2-1/2	63-830	63-880	5	16	6	64
63-724	63-774	1/4	3/8	1/4	2	63-832*		5	30	5	64
63-744 <sup>2</sup>	63-794 <sup>2</sup>	1/4	3/4	1/4	2-1/2	63-834		6	8	6	64
63-725	63-775	1/4	3/4	1/4	2-1/2	63-836	63-886	6	12	6	64
63-726	63-776	1/4	1-1/4	1/4	3	63-838	63-888	6	20	6	64
63-727*	63-777	1/4	1-1/2	1/4	3	63-840		6	30	6	76
63-730	63-780	3/8	5/8	3/8	2-1/2	63-842*	63-892*	6	38	6	76
63-731	63-781	3/8	3/4	3/8	3	63-844	63-894	8	25	8	64
63-733	63-783	3/8	1-1/8	3/8	3	63-846	63-896	8	38	8	76
63-735	63-785	3/8	1-5/8	3/8	3-1/2	63-848	63-898	10	30	10	76
63-745 <sup>2</sup>	63-795 <sup>2</sup>	3/8	1-5/8	3/8	3-1/2	63-849		10	35	10	76
63-740	63-790	1/2	1-5/8	1/2	3-1/2	63-847	63-897	12	38	12	76
63-746 <sup>2</sup>	63-796 <sup>2</sup>	1/2	1-5/8	1/2	3-1/2						

HELIX ANGLE ≈ 21°

<sup>2</sup> Special Point for Improved Bottom Finish

HELIX ANGLE ≈ 21°

**\* Tool balanced by design to run at spindle speeds up to 60,000 RPM**

## Single Flute - Solid Carbide Upcut Spiral O Flute

High speed cutters for machining aluminum sheet and block material. These tools are optimized for use on high-speed CNC mills, high speed machining centers and CNC routers.

**Usage** Aluminum plate and single/multi sheet aluminum, ACM

**Material**  See Selection Guide - pg. 2 - 12

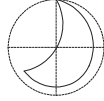

### METRIC (All dimensions in mm)

Part Number	Cutting DIA	LoC	SHK DIA	OAL
63-904	2	6	6	64
63-908	2.5	6	6	64
63-912	3	8	6	64
63-916	3	12	6	64
63-918	4	8	4	64
63-924	4	20	6	64
63-930	5	16	6	64
63-934	6	8	6	64
63-938	6	20	6	64
63-944	8	25	8	64
63-946	8	38	8	76
63-948	10	30	10	76

HELIX ANGLE ≈ 22°

63-900



## Single Flute - Solid Carbide Downcut Spiral O Flute

The polished flute allows for razor sharp cutting edge and easy chip evacuation. The tool is available in a down cut spiral for improved part holding.

**Usage** Plastic, wood, aluminum and solid surface

**Material**  See Selection Guide - pg. 2 - 12

See Selection Guide - pg. 2 - 12

### METRIC (All dimensions in mm)

Part Number	Cutting DIA	LoC	SHK DIA	OAL
64-012M	3	12	6	50
64-026M	6	32	6	76

HELIX ANGLE ≈ 21°

Part Number	Cutting DIA	LoC	SHK DIA	OAL
64-000*	1/16	1/4	1/8	2
64-012*	1/8	1/2	1/4	2
64-016*	3/16	3/8	3/16	2
64-018	3/16	5/8	1/4	2
64-024	1/4	3/8	1/4	2
64-025	1/4	3/4	1/4	2
64-026	1/4	1-1/4	1/4	3
64-031	3/8	3/4	3/8	3
64-033	3/8	1-1/8	3/8	3

HELIX ANGLE ≈ 21°

\* Tool balanced by design to run at spindle speeds up to 60,000 RPM

64-000



## 65-000



### Single Flute - Solid Carbide Upcut Spiral O Flute

The polished flute allows for razor sharp cutting edge and easy chip evacuation. The tool is available in a upcut spiral for improved chip evacuation.

**Usage** Plastic, wood, aluminum and solid surface

**Material** SW HW CW SP HP SSP A

See Selection Guide - pg. 2 - 12

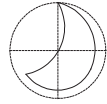

Part Number	Cutting DIA	LoC	SHK DIA	OAL
65-000*	1/16	1/4	1/8	2
65-010*	1/8	1/4	1/4	2
65-013*	1/8	1/2	1/8	2
65-012*	1/8	1/2	1/4	2
65-019*	3/16	5/8	3/16	2
65-018*	3/16	5/8	1/4	2
65-020*	3/16	1-1/4	1/4	3
65-021*	3/16	7/8	1/4	2-1/2
65-023	1/4	5/8	1/4	2

HELIX ANGLE ~ 21°

\* Tool balanced by design to run at spindle speeds up to 60,000 RPM

Part Number	Cutting DIA	LoC	SHK DIA	OAL
65-025	1/4	7/8	1/4	2-1/2
65-026	1/4	1-1/4	1/4	3
65-027*	1/4	1-1/2	1/4	3
65-033	3/8	1-1/8	3/8	3

\* Tool balanced by design to run at spindle speeds up to 60,000 RPM

#### METRIC (All dimensions in mm)

Part Number	Cutting DIA	LoC	SHK DIA	OAL
65-000M	2	6	3	50
65-018M	5	16	6	64
65-023M	6	16	6	64
65-033M	10	29	10	76

HELIX ANGLE ~ 22°

## 65-200B/ 65-300B



### Two & Four Flute - High Finish Ballnose for Plastics

The tool's unique geometry, specially designed point, and highly polished primary clearance and flute give the tool the ability to attain a surface finish of 28 Ra in mechanical plastic.

**Usage** Plastic

**Material** SP

See Selection Guide - pg. 2 - 12

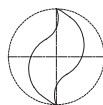

Two Flute

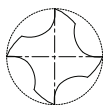

Four Flute

#### TWO FLUTE

Part Number	Cutting DIA	LoC	SHK DIA	OAL	Flutes
65-205B	1/16	1/4	1/8	2	2
65-210B	1/8	1/2	1/8	2-1/2	2
65-215B	3/16	1/2	1/4	2-1/2	2
65-220B	1/4	1/2	1/4	2-1/2	2
65-225B	1/4	1-1/8	1/4	3	2
65-235B	5/16	1/2	5/16	3	2
65-240B	5/16	1-1/8	5/16	3	2
65-250B	3/8	1-1/8	3/8	3	2
65-260B	1/2	1-1/8	1/2	3	2

#### TWO FLUTE METRIC (All dimensions in mm)

Part Number	Cutting DIA	LoC	SHK DIA	OAL	Flutes
65-280B	3	12	3	64	2
65-285B	6	20	6	76	2
65-290B	8	25	8	76	2
65-295B	10	30	10	76	2

#### FOUR FLUTE

Part Number	Cutting DIA	LoC	SHK DIA	OAL	Flutes
65-310B	1/4	1/2	1/4	3	4
65-315B	5/16	1/2	5/16	3	4
65-320B	3/8	5/8	3/8	3	4
65-325B	1/2	3/4	1/2	3	4

## Solid Carbide Edge Rounding

Designed for rounding the edge of sheets or parts. They come in both single flute and double flute.

**Usage** Edge rounding of parts

**Material**    See Selection Guide - pg. 2 - 12

### SINGLE FLUTE STRAIGHT O-FLUTE

Part Number	Cutting DIA	LoC	SHK DIA	OAL	Opening	Radius	Small Flute LGTH	Tip To RAD	Plastic Size
66-082	1/4	3/8	1/4	2-1/2	5/32	1/8	.195	1/16	1/8
66-083	1/4	3/8	1/4	2-1/2	7/32	3/16	.180	1/16	3/16
66-084	1/4	3/8	1/4	2-1/2	9/32	1/4	.163	1/16	1/4

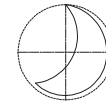

### SINGLE FLUTE SPIRAL O-FLUTE

Part Number	Cutting DIA	LoC	SHK DIA	OAL	Opening	Radius	Small Flute LGTH	Tip To RAD	Plastic Size
66-085	1/4	3/8	1/4	2-1/2	5/32	1/8	.195	1/16	1/8
66-086	1/4	3/8	1/4	2-1/2	7/32	3/16	.180	1/16	3/16
66-087	1/4	3/8	1/4	2-1/2	9/32	1/4	.163	1/16	1/4

HELIX ANGLE = 22°

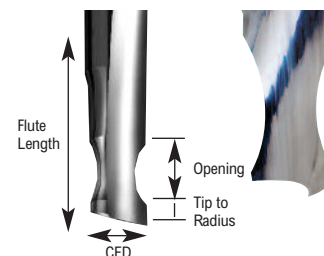

### DOUBLE FLUTE STRAIGHT O-FLUTE

Part Number	Cutting DIA	LoC	SHK DIA	OAL	Opening	Radius	Small Flute LGTH	Tip To RAD	Plastic Size
66-092	1/4	3/8	1/4	2-1/2	5/32	1/8	.195	1/16	1/8
66-093	1/4	3/8	1/4	2-1/2	7/32	3/16	.180	1/16	3/16
66-094	1/4	3/8	1/4	2-1/2	9/32	1/4	.163	1/16	1/4



### DOUBLE FLUTE STRAIGHT V-FLUTE

Part Number	Cutting DIA	LoC	SHK DIA	OAL	Opening	Radius	Small Flute LGTH	Tip To RAD	Plastic Size
66-120	3/8	3/8	3/8	2-1/2	5/32	1/8	.320	1/16	1/8
66-121	3/8	3/8	3/8	2-1/2	7/32	3/16	.305	1/16	3/16
66-122	3/8	3/8	3/8	2-1/2	9/32	1/4	.288	1/16	1/4
66-123	3/8	1/2	3/8	2-1/2	13/32	3/8	.255	1/16	3/8
66-160	1/2	3/8	1/2	3	5/32	1/8	.445	1/16	1/8
66-161	1/2	3/8	1/2	3	7/32	3/16	.430	1/16	3/16
66-162	1/2	3/8	1/2	3	9/32	1/4	.413	1/16	1/4
66-163	1/2	5/8	1/2	3	17/32	1/2	.347	1/16	1/2



## 66-200



### Double Flute - Solid Carbide Roud and Chamfer

Designed to provide up to a 1/16" top face chamfer and a finished side edge on plastic sheets or parts.

**Usage** Roud and chamfer in plastic

**Material** **SP** **HP** See Selection Guide - pg. 2 - 12

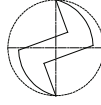

Part Number	Cutting DIA	LoC	SHK DIA	OAL	Material Thickness
66-200	1/4	3/16	3/8	2-1/4	1/8
66-204	1/4	1/4	3/8	2-1/4	3/16
66-210	3/8	5/16	1/2	3	1/4

HELIX ANGLE ≈ 0°

## 66-300



### Double Flute - Solid Carbide Upcut Bottom Surfacing

Designed for pocketing applications where the bottom of the pocket must be smooth.

**Usage** Bottom surfacing for plastic and aluminum

**Material** **SP** **HP** **A**  
See Selection Guide - pg. 2 - 12

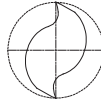

Part Number	Cutting DIA	Corner Radius	LoC	SHK DIA	OAL
66-308	1/8	.020	1/4	1/4	2
66-309	1/8	.002	1/4	1/4	2
66-314	1/4	.030	3/8	1/4	2
66-315	1/4	.002	3/8	1/4	2
66-320	3/8	.030	5/8	3/8	2-1/2
66-321	3/8	.002	5/8	3/8	2-1/2
66-326	1/2	.030	7/8	1/2	3
66-327	1/2	.002	7/8	1/2	3
66-328	3/4	.040	1-1/8	3/4	4

HELIX ANGLE ≈ 30°



# DFC Multi Flute Composite Router

Router to be used for roughing or finishing carbon fiber laminates. Multiple flutes eliminate vibration and control tool engagement. Chisel tooth design creates a compression effect to prevent delamination and fiber breakout. Diamond coated (DFC) for increased tool life.

**Usage** Composite and Fiberglass

**Material**  See Selection Guide - pg. 2 - 12

66-500



**NEW**

## METRIC (All dimensions in mm)

Part Number	Cutting DIA	LoC	SHK DIA	OAL	Flutes	Point Style
66-570	3	8	6	50	6	End Mill
66-572	3	8	6	50	6	Drill
66-574	4	11	6	50	6	End Mill
66-576	4	11	6	50	6	Drill
66-578	5	13	6	50	8	End Mill
66-580	5	13	6	50	8	Drill
66-582	6	13	6	50	10	End Mill
66-584	6	13	6	50	10	Drill
66-586	8	19	8	63	12	End Mill
66-588	8	19	8	63	12	Drill
66-590	10	22	10	72	12	End Mill
66-592	10	22	10	72	12	Drill
66-594	12	26	12	83	14	End Mill
66-596	12	26	12	83	14	Drill

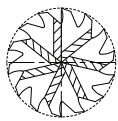

Burr Point

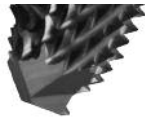

Drill Point

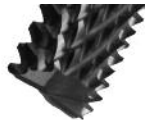

End Mill Point

Part Number	Cutting DIA	LoC	SHK DIA	OAL	Flutes	Point Style
66-501	1/8	1/4	1/8	2	6	Burr
66-502	1/8	1/4	1/8	2	6	End Mill
66-505	1/8	1/2	1/8	2	6	Burr
66-506	1/8	1/2	1/8	2	6	End Mill
66-507	1/8	1/2	1/8	2	6	Drill
66-509	3/16	3/8	3/16	2	8	Burr
66-510	3/16	3/8	3/16	2	8	End Mill
66-513	3/16	3/4	3/16	2 1/2	8	Burr
66-514	3/16	3/4	3/16	2 1/2	8	End Mill
66-515	3/16	3/4	3/16	2 1/2	8	Drill
66-517	1/4	1/2	1/4	2 1/2	10	Burr
66-518	1/4	1/2	1/4	2 1/2	10	End Mill
66-521	1/4	3/4	1/4	2 1/2	10	Burr
66-522	1/4	3/4	1/4	2 1/2	10	End Mill
66-525	1/4	1	1/4	3	10	Burr
66-526	1/4	1	1/4	3	10	End Mill
66-527	1/4	1	1/4	3	10	Drill
66-529	1/4	1 1/4	1/4	4	10	Burr
66-530	1/4	1 1/4	1/4	4	10	End Mill
66-533	3/8	3/4	3/8	2 1/2	12	Burr
66-534	3/8	3/4	3/8	2 1/2	12	End Mill
66-537	3/8	1 1/8	3/8	3	12	Burr
66-538	3/8	1 1/8	3/8	3	12	End Mill
66-539	3/8	1 1/8	3/8	3	12	Drill
66-541	3/8	1 1/4	3/8	3	12	Burr
66-542	3/8	1 1/4	3/8	3	12	End Mill
66-545	3/8	1 1/2	3/8	4	12	Burr
66-546	3/8	1 1/2	3/8	4	12	End Mill
66-549	1/2	1	1/2	3	14	Burr
66-550	1/2	1	1/2	3	14	End Mill
66-551	1/2	1	1/2	3	14	Drill
66-553	1/2	1 1/2	1/2	4	14	Burr
66-554	1/2	1 1/2	1/2	4	14	End Mill
66-557	1/2	2	1/2	4	14	Burr
66-558	1/2	2	1/2	4	14	End Mill

## 66-700



**NEW**

### DFC Low Helix Finisher - Upcut

These tools produce superior edge quality and finish in carbon fiber materials at high feed rates. The Multi-Flute design cuts quieter and faster than a typical two or three flute PCD tool in carbon fiber. DFC coated.

**Usage** Composite & Fiberglass

**Material** **CP**

See Selection Guide - pg. 2 - 12

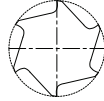

Six Flute

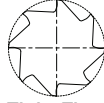

Eight Flute

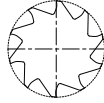

Ten Flute

Part Number	Cutting DIA	LoC	SHK DIA	OAL	Flutes
66-705	1/4	3/4	1/4	3-1/2	6
66-710	3/8	1-1/8	3/8	4	8
66-715	1/2	1-1/2	1/2	4	10

#### METRIC (All dimensions in mm)

Part Number	Cutting DIA	LoC	SHK DIA	OAL	Flutes
66-720	6	20	6	90	6
66-725	8	25	8	100	8
66-730	10	30	10	100	8
66-735	12	40	12	100	10

## 66-750



**NEW**

### DFC Low Helix Cutter - Upcut

Tool to be used as a rougher or finisher in carbon fiber laminates in tight tolerance applications. Low helix and optimized rake angles cleanly shear composite fibers to prevent delamination. Diamond coated (DFC) for increased tool life.

**Usage** Composite & Fiberglass

**Material** **CP**

See Selection Guide - pg. 2 - 12

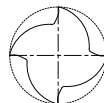

Four Flute

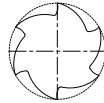

Six Flute

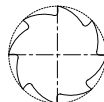

Eight Flute

Part Number	Cutting DIA	LoC	SHK DIA	OAL	Flutes
66-751	1/4	1/2	1/4	3	4
66-753	1/4	3/4	1/4	3	4
66-755	3/8	3/4	3/8	3	6
66-757	3/8	1 1/8	3/8	3	6
66-759	1/2	1	1/2	3	8
66-761	1/2	1 1/2	1/2	4	8

#### METRIC (All dimensions in mm)

Part Number	Cutting DIA	LoC	SHK DIA	OAL	Flutes
66-766	6	20	6	90	4
66-768	8	25	8	100	6
66-770	10	30	10	100	6
66-772	12	38	12	100	8

## DFC Low Helix Rougher Finisher - Upcut

Tool is designed as a combination roughing and finishing tool in one. The roughing profile reduces cutting forces and the geometry of the finishing flutes cleanly shear fibers leaving a smooth edge on the workpiece material. Diamond coated (DFC) for increased tool life.

**Usage** Composite & Fiberglass

**Material** **CP**  
See Selection Guide - pg. 2 - 12

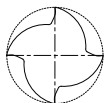

Four Flute

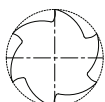

Six Flute

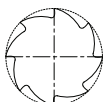

Eight Flute

Part Number	Cutting DIA	LoC	SHK DIA	OAL	Flutes
66-776	1/4	1/2	1/4	3	4
66-778	1/4	3/4	1/4	3	4
66-780	3/8	3/4	3/8	3	6
66-782	3/8	1 1/8	3/8	3	6
66-784	1/2	1	1/2	3	8
66-786	1/2	1 1/2	1/2	4	8

### METRIC (All dimensions in mm)

Part Number	Cutting DIA	LoC	SHK DIA	OAL	Flutes
66-791	6	20	6	90	4
66-793	8	25	8	100	6
66-795	10	30	10	100	6
66-797	12	38	12	100	8



**NEW**

## DFC Compression

New redesigned compression router with optimized geometry to eliminate delamination and fiber pullout. Compression design allows for better surface workpiece finishes. Enhanced diamond coating (DFC) to protect cutting edges for increased tool life.

**Usage** Composite & Fiberglass

**Material** **CP**  
See Selection Guide - pg. 2 - 12



Four Flute

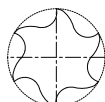

Six Flute

Part Number	Cutting DIA	Upcut LoC	LoC	SHK DIA	OAL	Flutes
66-802	1/4	0.250	3/4	1/4	2 1/2	4
66-812	3/8	0.375	1	3/8	3	4
66-814	3/8	0.340	1	3/8	3	6
66-822	1/2	0.450	1	1/2	3	4
66-824	1/2	0.450	1	1/2	3	6
66-826	1/2	0.450	1 1/2	1/2	4	4
66-828	1/2	0.450	1 1/2	1/2	4	6

### METRIC (All dimensions in mm)

Part Number	Cutting DIA	Upcut LoC	LoC	SHK DIA	OAL	Flutes
66-852	6	7.75	20	6	90	4
66-858	8	8.00	25	8	100	4
66-864	10	8.50	25	10	100	6
66-870	12	9.00	25	12	100	6



**NEW**

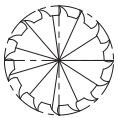

Burr Point

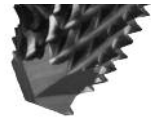

Drill Point

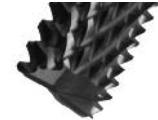
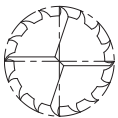

End Mill Point

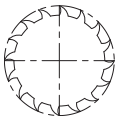

No Point

## High Performance Composite Router (Coated)

The High Performance Composite Router is designed for more efficient routing of composite materials, in both hand-fed and in CNC applications. Coated for increased tool life.

**Usage** Composites and fiberglass

**Material**  See Selection Guide - pg. 2 - 12

Part Number	Point Style	Cutting DIA	LoC	SHK DIA	OAL
66-901ALTIN	No	1/8	1/2	1/8	1-1/2
66-902ALTIN	BURR	1/8	1/2	1/8	1-1/2
66-903ALTIN	Endmill	1/8	1/2	1/8	1-1/2
66-904ALTIN	Drill	1/8	1/2	1/8	1-1/2
66-905ALTIN	No	3/16	5/8	1/4	2
66-906ALTIN	BURR	3/16	5/8	1/4	2
66-907ALTIN	Endmill	3/16	5/8	1/4	2
66-908ALTIN	Drill	3/16	5/8	1/4	2
66-909ALTIN	No	1/4	1	1/4	3
66-910ALTIN	BURR	1/4	1	1/4	3
66-911ALTIN	Endmill	1/4	1	1/4	3
66-912ALTIN	Drill	1/4	1	1/4	3
66-913ALTIN	No	1/4	1-1/2	1/4	3-1/2
66-914ALTIN	BURR	1/4	1-1/2	1/4	3-1/2
66-915ALTIN	Endmill	1/4	1-1/2	1/4	3-1/2
66-916ALTIN	Drill	1/4	1-1/2	1/4	3-1/2
66-917ALTIN	No	1/4	2-1/8	1/4	4
66-918ALTIN	BURR	1/4	2-1/8	1/4	4
66-919ALTIN	Endmill	1/4	2-1/8	1/4	4
66-920ALTIN	Drill	1/4	2-1/8	1/4	4
66-921ALTIN	No	3/8	1	3/8	3
66-922ALTIN	BURR	3/8	1	3/8	3
66-923ALTIN	Endmill	3/8	1	3/8	3
66-924ALTIN	Drill	3/8	1	3/8	3
66-925ALTIN	No	3/8	1-5/8	3/8	3-1/2
66-926ALTIN	BURR	3/8	1-5/8	3/8	3-1/2
66-927ALTIN	Endmill	3/8	1-5/8	3/8	3-1/2
66-928ALTIN	Drill	3/8	1-5/8	3/8	3-1/2
66-929ALTIN	No	3/8	2-1/8	3/8	4
66-930ALTIN	BURR	3/8	2-1/8	3/8	4
66-931ALTIN	Endmill	3/8	2-1/8	3/8	4
66-932ALTIN	Drill	3/8	2-1/8	3/8	4
66-933ALTIN	No	1/2	1-1/8	1/2	3
66-934ALTIN	BURR	1/2	1-1/8	1/2	3
66-935ALTIN	Endmill	1/2	1-1/8	1/2	3
66-936ALTIN	Drill	1/2	1-1/8	1/2	3
66-937ALTIN	No	1/2	1-5/8	1/2	4
66-938ALTIN	BURR	1/2	1-5/8	1/2	4

Part Number	Point Style	Cutting DIA	LoC	SHK DIA	OAL
66-939ALTIN	Endmill	1/2	1-5/8	1/2	4
66-940ALTIN	Drill	1/2	1-5/8	1/2	4
66-941ALTIN	No	1/2	2-1/8	1/2	4
66-942ALTIN	BURR	1/2	2-1/8	1/2	4
66-943ALTIN	Endmill	1/2	2-1/8	1/2	4
66-944ALTIN	Drill	1/2	2-1/8	1/2	4
66-945ALTIN	No	1/2	3-1/8	1/2	5
66-946ALTIN	BURR	1/2	3-1/8	1/2	5
66-947ALTIN	Endmill	1/2	3-1/8	1/2	5
66-948ALTIN	Drill	1/2	3-1/8	1/2	5
66-949ALTIN	No	1/2	4-1/8	1/2	6
66-950ALTIN	BURR	1/2	4-1/8	1/2	6
66-951ALTIN	Endmill	1/2	4-1/8	1/2	6
66-952ALTIN	Drill	1/2	4-1/8	1/2	6
66-971ALTIN	No	4mm	16mm	6mm	50mm
66-972ALTIN	BURR	4mm	16mm	6mm	50mm
66-973ALTIN	Endmill	4mm	16mm	6mm	50mm
66-974ALTIN	Drill	4mm	16mm	6mm	50mm
66-975ALTIN	No	6mm	19mm	6mm	75mm
66-976ALTIN	BURR	6mm	19mm	6mm	75mm
66-977ALTIN	Endmill	6mm	19mm	6mm	75mm
66-978ALTIN	Drill	6mm	19mm	6mm	75mm
66-979ALTIN	No	6mm	25mm	6mm	75mm
66-980ALTIN	BURR	6mm	25mm	6mm	75mm
66-981ALTIN	Endmill	6mm	25mm	6mm	75mm
66-982ALTIN	Drill	6mm	25mm	6mm	75mm
66-983ALTIN	No	8mm	25mm	8mm	63mm
66-984ALTIN	BURR	8mm	25mm	8mm	63mm
66-985ALTIN	Endmill	8mm	25mm	8mm	63mm
66-986ALTIN	Drill	8mm	25mm	8mm	63mm
66-987ALTIN	No	10mm	25mm	10mm	75mm
66-988ALTIN	BURR	10mm	25mm	10mm	75mm
66-989ALTIN	Endmill	10mm	25mm	10mm	75mm
66-990ALTIN	Drill	10mm	25mm	10mm	75mm
66-991ALTIN	No	12mm	25mm	12mm	75mm
66-992ALTIN	BURR	12mm	25mm	12mm	75mm
66-993ALTIN	Endmill	12mm	25mm	12mm	75mm
66-994ALTIN	Drill	12mm	25mm	12mm	75mm

# Solid Carbide Fiberglass Router

Designed as fiberglass routers. Their upcut/downcut diamond design effectively shears fibrous materials. Certain tools in the line have been further developed to cut aramid fiber composites.

**Usage** Fiberglass and composites

**Material**  See Selection Guide - pg. 2 - 12

**67-000**



## MEDIUM BURR W/END MILL POINT

Part Number	Cutting DIA	LoC	SHK DIA	OAL
67-003	1/8	1	1/8	2
67-010	1/4	3/4	1/4	2-1/2
67-011	1/4	1-1/8	1/4	3
67-012	1/4	1-1/4	1/4	3
67-014	1/4	1-1/2	1/4	3
67-017	1/4	2-1/8	1/4	4
67-030	3/8	7/8	3/8	2-1/2

## MEDIUM BURR W/END MILL POINT

Part Number	Cutting DIA	LoC	SHK DIA	OAL
67-023	3/8	1-5/8	3/8	3
67-027	3/8	2-1/8	3/8	4
67-031	1/2	1-1/8	1/2	3
67-033	1/2	1-5/8	1/2	4
67-037	1/2	2-1/8	1/2	4
67-039	1/2	3-1/8	1/2	5
67-065	3/4	4-1/8	3/4	6

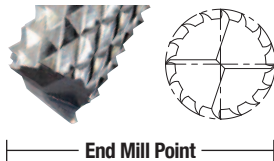

End Mill Point

## MEDIUM BURR W/END MILL POINT METRIC

Part Number	Cutting DIA	LoC	SHK DIA	OAL
67-096	3	12	3	52
67-097	4	16	4	64
67-098	6	19	6	76
67-099	6	25	6	76
67-101	8	25	8	76
67-102	10	25	10	76
67-103	12	25	12	76

## FINE BURR W/DRILL POINT

Part Number	Cutting DIA	LoC	SHK DIA	OAL
67-080	1/4	3/4	1/4	2-1/2
67-120	3/8	7/8	3/8	2-1/2
67-160	1/2	1	1/2	3

## FINE BURR W/DRILL POINT METRIC

Part Number	Cutting DIA	LoC	SHK DIA	OAL
67-090	4	16	6	50
67-091	6	19	6	76
67-092	6	25	6	76
67-093	8	25	8	76
67-094	10	25	10	76
67-095	12	25	12	76

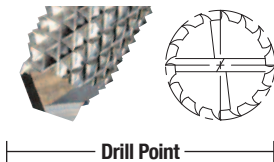

Drill Point

## 3 FLUTE DOWNCUT DIAMOND GRIT TOOL

Part Number	Cutting DIA	LoC	SHK DIA	OAL
67-254	1/4	1-1/8	1/4	3

## 3 FLUTE DOWNCUT DIAMOND GRIT TOOL

Part Number	Cutting DIA	LoC	SHK DIA	OAL
67-256	1/4	1-3/8	1/4	3
67-258	3/8	1-3/8	3/8	3

**67-250**



## 67-200

### Three Flute - Solid Carbide Phenolic Cutter

Equally adaptable to low or high spindle speed applications in any CNC machining environment. The free cutting action of the tools provides for better finishes and significantly lower noise levels.

**Usage** Phenolic

**Material**  See Selection Guide - pg. 2 - 12

#### UPCUT

Part Number	Cutting DIA	LoC	SHK DIA	OAL
67-205	3/8	7/8	3/8	3
67-211	1/2	1-1/8	1/2	3
67-215	1/2	2-1/8	1/2	4

HELIX ANGLE  $\approx 10^\circ$

#### METRIC (All dimensions in mm)

Part Number	Cutting DIA	LoC	SHK DIA	OAL
67-207	10	22	10	75
67-209	12	28	12	75

#### DOWNCUT

Part Number	Cutting DIA	LoC	SHK DIA	OAL
67-206	3/8	7/8	3/8	3
67-212	1/2	1-1/8	1/2	3-1/2
67-216	1/2	2-1/8	1/2	4-1/2

#### METRIC (All dimensions in mm)

Part Number	Cutting DIA	LoC	SHK DIA	OAL
67-208	10	22	10	75
67-210	12	28	12	75

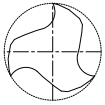

Three Flute

## 67-220

### Three Flute - PCD Progressive Chipbreaker for Composites

Provides superior chip control and increased tool life when cutting dense and abrasive materials. The new chipbreaker incorporates a unique geometry with a PCD cutting edge to support a wide range of feed rates and depth of cut combinations while extending the life of the tool. This is accomplished by utilizing a distinct Hi-Low asymmetrical chipbreaker profile which reduces vibration and chatter, caused by harmonic imbalance, resulting in improved surface finishes, while reducing noise levels and wear on the tool.

**Usage** Composites and phenolic

**Material**  See Selection Guide - pg. 2 - 12

Part Number	Cutting DIA	LoC	SHK DIA	OAL
67-221	3/8	3/8	3/8	3
67-225	1/2	5/8	1/2	3
67-227	1/2	1-1/8	1/2	3-1/2

#### METRIC (All dimensions in mm)

Part Number	Cutting DIA	LoC	SHK DIA	OAL
67-230	10	12	10	76
67-233	12	20	12	100



Three Flute

## Solid Carbide Un-Ruffer™<sup>PATENTED</sup>

The unique design allows for the cutting performance of a burr while achieving a good surface finish.

**Usage** Composite panels

**Material**  See Selection Guide - pg. 2 - 12

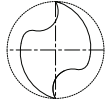

### METRIC (All dimensions in mm)

Part Number	Cutting DIA	LoC	SHK DIA	OAL
67-426M	6	25	6	64
67-435M	10	25	10	76
67-445M	12	25	12	76

Part Number	Cutting DIA	LoC	SHK DIA	OAL
67-423	1/4	3/4	1/4	2
67-426	1/4	1	1/4	2-1/2
67-428	1/4	1	1/4	3
67-435	3/8	1	3/8	3
67-445	1/2	1	1/2	3

67-400



## Solid Carbide CG Tool (Carbon Graphite)

The geometry of these tools increases the amount of effective cutting flutes resulting in superior performance over a standard burr.

**Usage** Carbon graphite and carbon fiber panels

**Material**  See Selection Guide - pg. 2 - 12

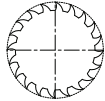

Part Number	Cutting DIA	LoC	SHK DIA	OAL
67-505	1/8	1/2	1/8	2
67-508	3/16	5/8	3/16	2
67-511	1/4	3/4	1/4	3
67-514	1/4	1-1/2	1/4	3
67-520	3/8	1-1/8	3/8	3-1/2
67-523	1/2	1-1/8	1/2	3-1/2
67-526	1/2	2-1/8	1/2	4

### METRIC (All dimensions in mm)

Part Number	Cutting DIA	LoC	SHK DIA	OAL
67-511M	6	20	6	76
67-520M	10	29	10	76
67-523M	12	29	12	88

67-500



## Solid Carbide 8 Facet Drill



Designed to reduce cutting forces and eliminating delamination when exiting the material.

**Usage** Composites, Carbon fiber, mechanical plastics, and fiber reinforced plastics

**Material** **CP** **SP** **HP**

See Selection Guide - pg. 2 - 12

### What is an 8 Facet Drill?

An 8 facet drill consists of 4 cutting edges with 2 facets per cutting edge. These facets consist of the lip relief and the lip clearance angle.

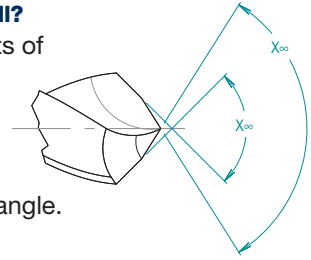

### FRACTIONAL DRILLS

Part Number	Cutting DIA	LoC	SHK DIA	OAL
67-807	1/8 (0.1250)	1-1/4	0.125	2-1/4
67-808	9/64 (0.1406)	1-3/8	0.140	2-1/2
67-809	5/32 (0.1563)	1-3/8	0.156	2-1/2
67-810	11/64 (0.1719)	1-5/8	0.172	2-3/4
67-811	3/16 (0.1875)	1-5/8	0.188	2-3/4
67-812	13/64 (0.2013)	1-3/4	0.203	3
67-813	7/32 (0.2188)	1-3/4	0.219	3
67-814	15/64 (0.2344)	2	0.234	3-1/4
67-815	1/4 (0.2500)	2	0.250	3-1/4
67-816	17/64 (0.2656)	2-1/8	0.266	3-1/2
67-817	9/32 (0.2813)	2-1/8	0.281	3-1/2
67-818	19/64 (0.2969)	2-3/8	0.297	3-3/4
67-819	5/16 (0.3125)	2-3/8	0.313	3-3/4
67-820	21/64 (0.3281)	2-1/2	0.328	4
67-821	11/32 (0.3438)	2-1/2	0.344	4
67-822	23/64 (0.3594)	2-1/2	0.359	4
67-823	3/8 (0.3750)	2-3/4	0.375	4-1/4
67-824	25/64 (0.3906)	2-7/8	0.391	4-1/2
67-825	13/32 (0.4063)	2-7/8	0.406	4-1/2
67-826	27/64 (0.4219)	2-7/8	0.422	4-1/2
67-827	7/16 (0.4375)	2-7/8	0.438	4-1/2
67-828	29/64 (0.4531)	3	0.453	4-3/4
67-829	15/32 (0.4688)	3	0.469	4-3/4
67-830	31/64 (0.4844)	3	0.484	4-3/4
67-831	1/2 (0.5000)	3	0.500	4-3/4

### LETTER DRILLS (CONT.)

Part Number	Cutting DIA	LoC	SHK DIA	OAL
67-850	A (0.2340)	2	0.234	3-1/4
67-851	B (0.2380)	2	0.238	3-1/4
67-852	C (0.2420)	2	0.242	3-1/4
67-853	D (0.2460)	2	0.246	3-1/4
67-854	E (0.2500)	2	0.250	3-1/4
67-855	F (0.2570)	2	0.257	3-1/4
67-856	G (0.2610)	2-1/8	0.261	3-1/2
67-857	H (0.2660)	2-1/8	0.266	3-1/2
67-858	I (0.2720)	2-1/8	0.272	3-1/2

### LETTER DRILLS (CONT.)

Part Number	Cutting DIA	LoC	SHK DIA	OAL
67-859	J (0.2770)	2-1/8	0.277	3-1/2
67-860	K (0.2810)	2-1/8	0.281	3-1/2
67-861	L (0.2900)	2-1/8	0.290	3-1/2
67-862	M (0.2950)	2-3/8	0.295	3-3/4
67-863	N (0.3020)	2-3/8	0.302	3-3/4
67-864	O (0.3160)	2-3/8	0.316	3-3/4
67-865	P (0.3230)	2-3/8	0.323	3-3/4
67-866	Q (0.3320)	2-1/2	0.332	4
67-867	R (0.3390)	2-1/2	0.339	4
67-868	S (0.3480)	2-1/2	0.348	4
67-869	T (0.3580)	2-1/2	0.358	4
67-870	U (0.3680)	2-3/4	0.368	4-1/4
67-871	V (0.3770)	2-3/4	0.377	4-1/4
67-872	W (0.3860)	2-7/8	0.386	4-1/2
67-873	X (0.3970)	2-7/8	0.397	4-1/2
67-874	Y (0.4040)	2-7/8	0.404	4-1/2
67-875	Z (0.4130)	2-7/8	0.413	4-1/2

### NUMBER DRILLS

Part Number	Cutting DIA	LoC	SHK DIA	OAL
67-876	1 (0.2280)	1-3/4	0.228	3
67-877	2 (0.2210)	1-3/4	0.221	3
67-878	3 (0.2130)	1-3/4	0.213	3
67-879	4 (0.2090)	1-3/4	0.209	3
67-880	5 (0.2055)	1-3/4	0.206	3
67-881	6 (0.2040)	1-3/4	0.204	3
67-882	7 (0.2010)	1-3/4	0.201	3
67-883	8 (0.1990)	1-3/4	0.199	3
67-884	9 (0.1960)	1-3/4	0.196	3
67-885	10 (0.1935)	1-5/8	0.194	2-3/4
67-886	11 (0.1910)	1-5/8	0.191	2-3/4
67-887	12 (0.1890)	1-5/8	0.189	2-3/4
67-888	13 (0.1850)	1-5/8	0.185	2-3/4
67-889	14 (0.1820)	1-5/8	0.182	2-3/4
67-890	15 (0.1800)	1-5/8	0.180	2-3/4
67-891	16 (0.1770)	1-5/8	0.177	2-3/4
67-892	17 (0.1730)	1-5/8	0.173	2-3/4

### NUMBER DRILLS (CONT.)

Part Number	Cutting DIA	LoC	SHK DIA	OAL
67-893	18 (0.1695)	1-5/8	0.170	2-3/4
67-894	19 (0.1660)	1-5/8	0.166	2-3/4
67-895	20 (0.1610)	1-3/8	0.161	2-1/2
67-896	21 (0.1590)	1-3/8	0.159	2-1/2
67-897	22 (0.1570)	1-3/8	0.157	2-1/2
67-898	23 (0.1540)	1-3/8	0.154	2-1/2
67-899	24 (0.1520)	1-3/8	0.152	2-1/2
67-900	25 (0.1495)	1-3/8	0.150	2-1/2
67-901	26 (0.1470)	1-3/8	0.147	2-1/2
67-902	27 (0.1440)	1-3/8	0.144	2-1/2
67-903	28 (0.1405)	1-3/8	0.141	2-1/2
67-904	29 (0.1360)	1-3/8	0.136	2-1/2
67-905	30 (0.1285)	1-1/4	0.129	2-1/4
67-906	31 (0.1200)	1-1/4	0.120	2-1/4

### METRIC DRILLS

Part Number	Cutting DIA	LoC	SHK DIA	OAL
67-961	3.00 (0.1181)	32	3.00	57
67-962	3.50 (0.1378)	35	3.50	64
67-963	4.00 (0.1575)	35	4.00	64
67-964	4.50 (0.1772)	41	4.50	70
67-965	5.00 (0.1969)	44	5.00	76
67-966	5.50 (0.2165)	44	5.50	76
67-967	6.00 (0.2362)	51	6.00	83
67-968	6.50 (0.2559)	51	6.50	83
67-969	7.00 (0.2756)	57	7.00	89
67-970	7.50 (0.2953)	60	7.50	95
67-971	8.00 (0.3150)	60	8.00	95
67-972	8.50 (0.3346)	64	8.50	102
67-973	9.00 (0.3543)	64	9.00	102
67-974	9.50 (0.3740)	70	9.50	108
67-975	10.00 (0.3937)	73	10.00	114
67-976	10.50 (0.4134)	73	10.50	114
67-977	11.00 (0.4331)	73	11.00	114
67-978	11.50 (0.4528)	76	11.50	121
67-979	12.00 (0.4724)	76	12.00	121



## Double Flute - PCD Tipped Tooling

Designed for use in abrasive materials where cut quality and tool life are important.

**Usage** Composite panels and fiberglass

**Material** **CP** See Selection Guide - pg. 2 - 12

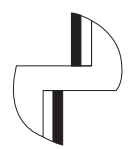

PCD Tipped

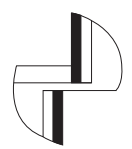

PCD Full Face with Plunge Point

### PCD FULL FACE

Part Number	Cutting DIA	LoC	SHK DIA	OAL
68-005	1/4	3/4	1/4	3
68-010	3/8	3/4	3/8	3
68-020	1/2	3/4	1/2	4
68-030	3/4	1	3/4	4

HELIX ANGLE ≈ 0-3°

### PCD FULL FACE with PLUNGE POINT

Part Number	Cutting DIA	LoC	SHK DIA	OAL
68-050	1/4	3/4	1/4	3
68-055	3/8	7/8	3/8	3
68-062	1/2	1-1/4	1/2	4
68-070	3/4	1-1/4	3/4	4
68-072	3/4	1-1/4	3/4	4

Down Shear



## Single Flute - PCD Compression Tool

This economical PCD compression tool will provide long tool life in abrasive wood products. Mortise tip allowing for through cuts and dado's to be produced using one tool. The compression design ensures chip free edges on the top and bottom.

**Usage** Composite & natural woods

**Material** **CW SW HW LW**  
See Selection Guide - pg. 2 - 12

Part Number	Cutting DIA	LoC	Upcut LoC	SHK DIA	OAL	Flutes
68-101	3/8	1	0.188	3/8	3	1
68-101L	3/8	1	0.188	3/8	3	1
68-100	3/8	1	0.188	1/2	3	1
68-100L	3/8	1	0.188	1/2	3	1
68-102	1/2	1	0.200	1/2	3	1
68-102L	1/2	1	0.200	1/2	3	1
68-103	1/2	1-1/4	0.200	1/2	3	1
68-104	5/8	1	0.200	5/8	3-1/2	1

Part Number	Cutting DIA	LoC	Upcut LoC	SHK DIA	OAL	Flutes
68-104L*	5/8	1	0.200	5/8	3-1/2	1
68-110	5/8	1-5/8	0.200	5/8	4	1
68-110L*	5/8	1-5/8	0.200	5/8	4	1
68-106	3/4	1	0.200	3/4	4	1
68-106L*	3/4	1	0.200	3/4	4	1
68-112	3/4	1-5/8	0.200	3/4	4	1
68-112L*	3/4	1-5/8	0.200	3/4	4	1

L = Left Hand Rotation  
\* = Tools are not stocked and must be special ordered. Approx. 4 week lead time.



## 68-200



### Double Flute - PCD SERF™ Cutter

This tool is designed to act like a rougher and finishing tool in one. The unique geometry reduces the cutting forces resulting in longer tool life, higher feed rates and reduced noise.

**Usage** Composites and fiberglass

**Material**  See Selection Guide - pg. 2 - 12

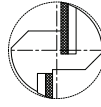

#### METRIC (All dimensions in mm)

Part Number	Cutting DIA	LoC	SHK DIA	OAL
68-213M	6	20	6	76
68-226M	10	25	10	88
68-236M	12	32	12	100

Part Number	Cutting DIA	LoC	SHK DIA	OAL
68-210	1/4	3/8	1/4	3
68-213	1/4	3/4	1/4	3
68-216	1/4	1	1/4	3-1/2
68-220	3/8	3/8	3/8	3
68-223	3/8	3/4	3/8	3
68-226	3/8	1	3/8	3-1/2
68-230	1/2	3/4	1/2	4
68-233	1/2	1	1/2	4
68-236	1/2	1-1/4	1/2	4

## 68-300



### Three Flute - PCD SERFIN™ Cutter

Three-Flute tool with two roughing edges that have geometry to reduce cutting forces and shear fibers in high-strength composite and other fiber reinforced plastic materials. The finishing edge cleans up after roughing cuts to create a smooth edge on material.

**Usage** Composites and fiberglass

**Material**  See Selection Guide - pg. 2 - 12

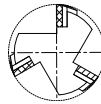

Part Number	Cutting DIA	LoC	SHK DIA	OAL
68-315	3/8	1/2	3/8	4
68-320	3/8	7/8	3/8	4
68-340	1/2	5/8	1/2	4
68-345	1/2	1	1/2	4
68-350	1/2	1-1/4	1/2	4
68-360	3/4	1-3/8	3/4	5

#### METRIC (All dimensions in mm)

Part Number	Cutting DIA	LoC	SHK DIA	OAL
68-310	8	10	8	76
68-325	10	14	10	100
68-330	12	14	12	100
68-335	12	26	12	100
68-355	16	26	16	100

## 68-400



### Double Flute - PCD Ballnose

Designed for use in abrasive materials where cut quality and tool life are important.

**Usage** Composites and fiberglass

**Material**  See Selection Guide - pg. 2 - 12

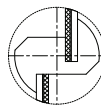

Part Number	Cutting DIA	LoC	SHK DIA	OAL
68-405	1/4	3/8	1/4	2-1/2
68-410	3/8	1/2	3/8	3
68-420	1/2	5/8	1/2	4
68-425	5/8	7/8	5/8	4
68-430	3/4	1	3/4	4

#### METRIC (All dimensions in mm)

Part Number	Cutting DIA	LoC	SHK DIA	OAL
68-440	6	10	6	76
68-445	8	10	8	76
68-450	10	12	10	76
68-455	12	20	12	100

**NEW**

## PCD 8 Facet Drills

The PCD 8 facet drill works well in composite material where long tool life and a delamination free hole is required. The drill diameters are oversize allowing for aircraft fasteners to extend through the holes.

**Usage** Composites

**Material**  See Selection Guide - pg. 2 - 12

### What is an 8 Facet Drill?

An 8 facet drill consists of 4 cutting edges with 2 facets per cutting edge. These facets consist of the lip relief and the lip clearance angle.

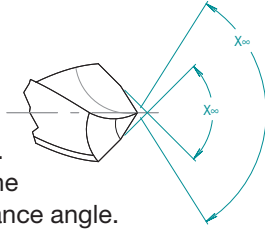

Part Number	Cutting DIA	LoC	SHK DIA	OAL
68-902	0.100	1	1/4	3
68-904	0.129	1	1/4	3
68-908	0.147	1	1/4	3
68-910	0.192	1	1/4	3
68-914	0.251	1	1/4	3
68-918	0.313	1	5/16	3
68-922	0.376	1	3/8	3
68-926	0.502	1	1/2	3

68-900



## Carbide Tipped Trim Blade and Arbor

Designed to trim and groove both hard and soft plastics. These blades run in conjunction with the blade arbors. Blades are reversible for right or left hand rotation cutting.

**Usage** Hard and soft plastic

**Material**   See Selection Guide - pg. 2 - 12

### SOFT PLASTIC - SLOW FEED

Part Number	Cutting DIA	Teeth	Rake	Kerf	Grind
70-100	2	10	0°	.095	TCG
70-102	2-1/2	10	0°	.095	TCG
70-104	3	10	0°	.095	TCG
70-108	4	10	0°	.095	TCG

### SOFT PLASTIC - FAST FEED

Part Number	Cutting DIA	Teeth	Rake	Kerf	Grind
70-120	2	16	0°	.095	TCG
70-122	2-1/2	20	0°	.095	TCG
70-124	3	20	0°	.095	TCG
70-126	3-1/2	20	0°	.095	TCG
70-128	4	20	0°	.095	TCG

### HARD PLASTIC - FAST FEED

Part Number	Cutting DIA	Teeth	Rake	Kerf	Grind
70-160	2	16	-5°	.095	TCG
70-162	2-1/2	20	-5°	.095	TCG
70-164	3	20	-5°	.095	TCG
70-166	3-1/2	20	-5°	.095	TCG
70-168	4	20	-5°	.095	TCG

TCG = Triple Chip Grind

**SAW ARBOR** - These saw arbors are designed to hold the carbide tipped saws.

Part Number	Cutting DIA	OAL
70-180	1/2	3-1/4
70-181	1/2	4-1/2

\*SEE FEED & SPEED CHART ON PAGE 67.

70-100



## 70-200



### Solid Carbide Trim Blade Flush Mount

These small diameter solid carbide arbor mounted blades are designed for trimming and slotting plastics. Blades are permanently attached to arbors and are not reversible.

**Usage** Hard and soft plastic

**Material** **SP** **HP**

See Selection Guide - pg. 2 - 12

Part Number	Cutting DIA	Collar	SHK DIA	Kerf	OAL	Rotation
70-204	1	9/16	1/2	.062	4	Right
70-224	1-1/4	5/8	1/2	.062	4	Right

\*SEE FEED & SPEED CHART BELOW

## 70-300



### Carbide Tipped Trim Blade Flush Mount

Designed for flush trimming and slotting of both hard and soft plastics. Blades are permanently attached to arbors and are not reversible.

**Usage** Hard and soft plastic

**Material** **SP** **HP** See Selection Guide - pg. 2 - 12

Part Number	Cutting DIA	Teeth	Rake	SHK DIA	Kerf	OAL	Grind	Rotation	Plastic	Feed
70-300	2	10	0°	1/2	.095	4	TCG	RH	Soft	Slow
70-302	2	10	0°	1/2	.095	4	TCG	LH	Soft	Slow
70-320	2	16	0°	1/2	.095	4	TCG	RH	Soft	Fast
70-322	2	16	0°	1/2	.095	4	TCG	LH	Soft	Fast
70-340	2	10	-5°	1/2	.095	4	TCG	RH	Hard	Slow
70-342	2	10	-5°	1/2	.095	4	TCG	LH	Hard	Slow
70-360	2	16	-5°	1/2	.095	4	TCG	RH	Hard	Fast
70-362	2	16	-5°	1/2	.095	4	TCG	LH	Hard	Fast

\*SEE FEED & SPEED CHART BELOW  
TCG = Triple Chip Grind

### Feeds & Speeds for Blades INCHES PER MINUTE

Tool Series	Cutting DIA	Max RPM	Soft Plastic	Hard Plastic	Fibrous Reinfr
70-100	2"	18,000	150	150	150
70-100	2-1/2"	16,000	150	150	150
70-100	3"	14,000	150	150	150
70-100	3-1/2"	12,000	150	150	150
70-100	4"	10,000	150	150	150
70-200	1-1/2" & Smaller	14,000	150	150	150
70-300	2"	16,000	150	150	150

# HSS Plastic Drill

Designed to produce holes in hard and soft plastic while eliminating edge chipping and chip wrapping.

**Usage** Hard and soft plastic

**Material** **SP** **HP** See Selection Guide - pg. 2 - 12



- NO Wrapping
- NO Cleaning
- NO Melting
- NO Surface Marring
- NO Interrupted Operation



### FRACTIONAL DRILLS

Part Number	Cutting DIA	LoC	SHK DIA	OAL
70-502	1/8 (0.125)	1-1/2	1/8	2-3/4
70-503	9/64 (0.141)	1-3/4	9/64	2-7/8
70-506	5/32 (0.156)	1-15/16	5/32	3-1/8
70-509	11/64 (0.172)	1-3/4	11/64	3-1/4
70-510	3/16 (0.188)	2-1/8	3/16	3-1/2
70-511	13/64 (0.203)	2-7/16	13/64	3-5/8
70-512	7/32 (0.219)	2-1/2	7/32	3-3/4
70-513	15/64 (0.234)	2-5/8	15/64	3-7/8
70-514	1/4 (0.250)	2-7/16	1/4	4
70-515	17/64 (0.266)	2-7/8	17/64	4-1/8
70-516	9/32 (0.281)	2-15/16	9/32	4-1/4
70-517	19/64 (0.297)	3-1/16	19/64	4-3/8
70-520	5/16 (0.313)	1-3/4	1/4	3-1/8
70-521	21/64 (0.328)	3-5/16	21/64	4-5/8
70-522	11/32 (0.344)	3-7/16	11/32	4-3/4
70-523	23/64 (0.359)	3-1/2	23/64	4-7/8
70-524	3/8 (0.375)	2-1/4	1/4	4-3/8
70-525	25/64 (0.391)	3-3/4	25/64	5-1/8
70-526	13/32 (0.406)	3-7/8	13/32	5-1/8
70-527	27/64 (0.422)	3-15/16	27/64	5-3/8
70-528	7/16 (0.438)	2-1/2	1/4	4-3/4
70-529	29/64 (0.453)	4-3/16	29/64	5-5/8
70-530	15/32 (0.469)	4-5/16	15/32	5-3/4
70-531	31/64 (0.484)	4-3/8	31/64	5-7/8
70-532	1/2 (0.500)	2-5/8	1/4	5-1/8
70-533	33/64 (0.516)	3-1/8	1/2	6
70-534	17/32 (0.531)	3-1/8	1/2	6
70-535	35/64 (0.547)	3-1/8	1/2	6
70-536	9/16 (0.563)	3-1/8	1/2	6
70-537	37/64 (0.578)	3-1/8	1/2	6
70-538	19/32 (0.594)	3-1/8	1/2	6
70-539	39/64 (0.609)	3-1/8	1/2	6
70-540	5/8 (0.625)	3-1/8	1/2	6
70-541	41/64 (0.641)	3-1/8	1/2	6
70-542	21/32 (0.656)	3-1/8	1/2	6
70-543	43/64 (0.672)	3-1/8	1/2	6
70-544	11/16 (0.688)	3-1/8	1/2	6
70-545	45/64 (0.703)	3-1/8	1/2	6
70-546	23/32 (0.719)	3-1/8	1/2	6
70-547	47/64 (0.734)	3-1/8	1/2	6
70-548	3/4 (0.750)	3-1/8	1/2	6
70-549	49/64 (0.766)	3-1/8	1/2	6
70-550	25/32 (0.781)	3-1/8	1/2	6
70-551	51/64 (0.797)	3-1/8	1/2	6
70-552	13/16 (0.813)	3-1/8	1/2	6
70-553	53/64 (0.828)	3-1/8	1/2	6
70-554	27/32 (0.844)	3-1/8	1/2	6
70-555	55/64 (0.859)	3-1/8	1/2	6
70-556	7/8 (0.875)	3-1/8	1/2	6
70-557	57/64 (0.891)	3-1/8	1/2	6
70-558	29/32 (0.906)	3-1/8	1/2	6
70-559	59/64 (0.922)	3-1/8	1/2	6
70-560	15/16 (0.938)	3-1/8	1/2	6

### FRACTIONAL DRILLS (CONT.)

Part Number	Cutting DIA	LoC	SHK DIA	OAL
70-561	61/64 (0.953)	3-1/8	1/2	6
70-562	31/32 (0.969)	3-1/8	1/2	6
70-563	63/64 (0.984)	3-1/8	1/2	6

### LETTER DRILLS

Part Number	Cutting DIA	LoC	SHK DIA	OAL
70-600	A (0.234)	2-5/8	0.234	3-7/8
70-601	B (0.238)	2-3/4	0.238	4
70-602	C (0.242)	2-3/4	0.242	4
70-603	D (0.246)	2-3/4	0.246	4
70-604	E (0.250)	2-3/4	0.250	4
70-605	F (0.257)	2-7/8	0.257	4-1/8
70-606	G (0.261)	2-7/8	0.261	4-1/8
70-607	H (0.266)	2-7/8	0.266	4-1/8
70-608	I (0.272)	2-7/8	0.272	4-1/8
70-609	J (0.277)	2-7/8	0.277	4-1/8
70-610	K (0.281)	2-15/16	0.281	4-1/4
70-611	L (0.290)	2-15/16	0.290	4-1/4
70-612	M (0.295)	3-1/16	0.295	4-3/8
70-613	N (0.302)	3-1/16	0.302	4-3/8
70-614	O (0.316)	3-3/16	0.316	4-1/2
70-615	P (0.323)	3-5/16	0.323	4-5/8
70-616	Q (0.332)	3-7/16	0.332	4-3/4
70-617	R (0.339)	3-7/16	0.339	4-3/4
70-618	S (0.348)	3-1/2	0.348	4-7/8
70-619	T (0.358)	3-1/2	0.358	4-7/8
70-620	U (0.368)	3-5/8	0.368	5
70-621	V (0.377)	3-5/8	0.377	5
70-622	W (0.386)	3-3/4	0.386	5-1/8
70-623	X (0.397)	3-3/4	0.397	5-1/8
70-624	Y (0.404)	3-7/8	0.404	5-1/4
70-625	Z (0.413)	3-15/16	0.413	5-1/4

### WIRE DRILLS

Part Number	Cutting DIA	LoC	SHK DIA	OAL
70-630	1 (0.228)	2-5/8	0.228	3-7/8
70-631	2 (0.221)	2-5/8	0.221	3-7/8
70-632	3 (0.213)	2-1/2	0.213	3-3/4
70-633	4 (0.209)	2-1/2	0.209	3-3/4
70-634	5 (0.206)	2-1/2	0.206	3-3/4
70-635	6 (0.204)	2-1/2	0.204	3-3/4
70-636	7 (0.201)	2-7/16	0.201	3-5/8
70-637	8 (0.199)	2-7/16	0.199	3-5/8
70-638	9 (0.196)	2-7/16	0.196	3-5/8
70-639	10 (0.194)	2-7/16	0.194	3-5/8
70-640	11 (0.191)	2-5/16	0.191	3-1/2
70-641	12 (0.189)	2-5/16	0.189	3-1/2
70-642	13 (0.185)	2-5/16	0.185	3-1/2

### WIRE DRILLS

Part Number	Cutting DIA	LoC	SHK DIA	OAL
70-643	14 (0.182)	2-3/16	0.182	3-3/8
70-644	15 (0.180)	2-3/16	0.180	3-3/8
70-645	16 (0.177)	2-3/16	0.177	3-3/8
70-646	17 (0.173)	2-3/16	0.173	3-3/8
70-647	18 (0.170)	2-1/8	0.170	3-1/4
70-648	19 (0.166)	2-1/8	0.166	3-1/4
70-649	20 (0.161)	2-1/8	0.161	3-1/4
70-650	21 (0.159)	2-1/8	0.159	3-1/4
70-651	22 (0.157)	2	0.157	3-1/8
70-652	23 (0.154)	2	0.154	3-1/8
70-653	24 (0.152)	2	0.152	3-1/8
70-654	25 (0.150)	1-7/8	0.150	3
70-655	26 (0.147)	1-7/8	0.147	3
70-656	27 (0.144)	1-7/8	0.144	3
70-657	28 (0.141)	1-3/4	0.141	2-7/8
70-658	29 (0.136)	1-3/4	0.136	2-7/8
70-659	30 (0.129)	1-5/8	0.129	2-3/4
70-660	31 (0.120)	1-5/8	0.120	2-3/4

### METRIC DRILLS

Part Number	Cutting DIA	LoC	SHK DIA	OAL
70-714	3.00 (0.118)	41	3.00	70
70-715	3.50 (0.138)	44	3.50	73
70-716	4.00 (0.157)	54	4.00	83
70-717	4.50 (0.177)	56	4.50	86
70-718	5.00 (0.197)	62	5.00	92
70-719	5.50 (0.217)	64	5.50	95
70-720	6.00 (0.236)	70	6.00	102
70-721	6.50 (0.256)	73	6.50	105
70-722	7.00 (0.276)	73	7.00	105
70-723	7.50 (0.295)	78	7.50	111
70-724	8.00 (0.315)	81	8.00	114
70-725	8.50 (0.335)	87	8.50	121
70-726	9.00 (0.354)	89	9.00	124
70-727	9.50 (0.374)	92	9.50	127
70-728	10.00 (0.394)	95	10.00	130
70-729	10.50 (0.413)	98	10.50	133
70-730	11.00 (0.433)	103	11.00	140
70-731	11.50 (0.453)	106	11.50	143
70-732	12.00 (0.472)	111	12.00	149
70-733	12.50 (0.492)	114	12.50	152
70-734	13.00 (0.512)	114	13.00	152

# 72-000



Through Hole Brad Point



Hinge

## Solid Carbide Boring Bits

Two style of tools are available in this series. The brad point drill is designed to cut blind holes and produce a clean edge on the top surface. The 60° through drill is designed to produce through holes while providing clean edges on both sides.

**Usage** Wood

**Material** SW HW CW LW

See Selection Guide - pg. 2 - 12

**BRAD POINT** - designed to produce a blind hole while preventing fraying on the top edge.

**THROUGH HOLE (60° POINT)** - produces a through hole and reduces fraying on the entry and exit edges.

### RIGHT HAND ROTATION

Part Number	Cutting DIA	SHK DIA	OAL	Part Number	Cutting DIA	SHK DIA	OAL
72-001	3	10	57	72-021	3	10	70
72-005	5	10	57	72-025	5	10	70
72-009	6	10	57	72-029	6	10	70
72-013	8	10	57	72-033	8	10	70

### RIGHT HAND ROTATION

Part Number	Cutting DIA	SHK DIA	OAL	Part Number	Cutting DIA	SHK DIA	OAL
72-053	3	10	57	72-075	3	10	70
72-057	5	10	57	72-079	5	10	70
72-061	6	10	57	72-083	6	10	70
72-065	8	10	57	72-087	8	10	70

### LEFT HAND ROTATION

Part Number	Cutting DIA	SHK DIA	OAL	Part Number	Cutting DIA	SHK DIA	OAL
72-002	3	10	57	72-022	3	10	70
72-006	5	10	57	72-026	5	10	70
72-010	6	10	57	72-030	6	10	70
72-014	8	10	57	72-034	8	10	70

### LEFT HAND ROTATION

Part Number	Cutting DIA	SHK DIA	OAL	Part Number	Cutting DIA	SHK DIA	OAL
72-054	3	10	57	72-076	3	10	70
72-058	5	10	57	72-080	5	10	70
72-062	6	10	57	72-084	6	10	70
72-066	8	10	57	72-088	8	10	70

**HINGE BIT** - This 35mm carbide tipped bit is designed to produce a flat bottom hole with clean edges for hinge mounting.

Part Number	Cutting DIA	SHK DIA	OAL
72-097	35	10	70

**77-100**

**Double or Three Flute Solid Carbide Taper Tools**

The taper tools are available with a variety of taper angles and come standard with a ball nose point. The tools are designed to produce a good edge finish in a wide variety of materials.

**Usage** Wood, plastic and aluminum

**Material** SW HW CW



See Selection Guide - pg. 2 - 12

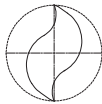

Two Flute

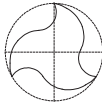

Three Flute

Part Number	Cutting DIA	LoC	SHK DIA	OAL	Angle Per Side	Radius	Flutes
77-102	1/8	1-1/2	1/4	3	1°	1/16	3
77-104	1/8	1	1/4	3	3°	1/16	3
77-106	1/8	3/4	1/4	3	5°	1/16	3
77-108	1/8	1/2	1/4	3	7°	1/16	3
77-112	1/4	2	1/2	4	3°	1/8	2
77-114	1/4	1-3/8	1/2	4	5°	1/8	2
77-116	1/4	1	1/2	4	7°	1/8	2



**METRIC**

Part Number	Cutting DIA	LoC	SHK DIA	OAL	Angle Per Side	Radius	Flutes
77-102M	3mm	39mm	6mm	76mm	1°	1.5mm	3
77-104M	3mm	25mm	6mm	76mm	3°	1.5mm	3
77-106M	3mm	19mm	6mm	76mm	5°	1.5mm	3
77-108M	3mm	12mm	6mm	76mm	7°	1.5mm	3
77-112M	6mm	50mm	12mm	100mm	3°	3mm	2
77-114M	6mm	35mm	12mm	100mm	5°	3mm	2
77-116M	6mm	25mm	12mm	100mm	7°	3mm	2

**Three Flute - High Speed Steel Taper Pin Router**

**80-000**

These three flute upcuts with a tapered flute are used for profiling and trimming primarily in aircraft assembly operations.

**Usage** Aluminum

**Material** A See Selection Guide - pg. 2 - 12

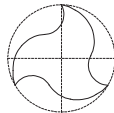

Part Number	Cutting DIA	LoC	SHK DIA	OAL
80-001	.098	3/4	.098	2
80-002	.110	7/8	.128	2 1/4
80-003	.165	1 1/16	.1875	2 1/2

HELIX ANGLE ≈ 24°



## 81-000



### Double Flute - High Speed Steel Lo Helix

These lo helix upcut spirals were developed for CNC routers used primarily in the aircraft industry. They are designed with maximum strength of configuration to cut T, O or combined stacks of aluminum-using coolant.

**Usage** Aluminum

**Material**  See Selection Guide - pg. 2 - 12

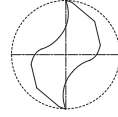

Part Number	Cutting DIA	LoC	SHK DIA	OAL	Helix	ALUM Condition
81-001	1/4	3/4	1/2	3 1/16	5°	T
81-003	5/16	3/4	1/2	3 1/16	10°	C

## 81-100



### Double Flute - Solid Carbide Spiral Extrusion Cutters

Designed for reduced vibration producing smoother finish cuts. Extended reach during side thinning and gage reduction. Longer tool life to reduce tool changes.

**Usage** Extrusion and sheet aluminum.  
Optimized for use on multi-head extrusion mills CNC mills and routers

**Material**  See Selection Guide - pg. 2 - 12

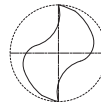

Part Number	Cutting DIA	LoC	ERL	SHK DIA	OAL	Helix & DIR	Flutes	CNR RAD Chamfer	Aluminum Condition	Machining Environment
Tolerance	+.002	±.03		+.0000 -.0005	±.03					
81-103	5/16	13/16	-	1/2	3	10°RH	2	.02 x 45°	C	Wet
81-104	3/8	13/16	-	1/2	3	10°RH	2	.02 x 45°	O	Wet

## 83-300



### Double Flute - Solid Carbide Coated Upcut Spiral for Stainless Steel

Special cutting geometry is required to cut stainless steel and achieve decent tool life. LMT Onsrud has developed a line of cutters which are capable of cutting stainless steel.

**Usage** Stainless Steel

**Material**  See Selection Guide - pg. 2 - 12

**Note** Use with MQL is preferred

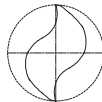

Part Number	Cutting DIA	LoC	SHK DIA	OAL
83-305AITiN	1/8	1/4	1/8	2
83-310AITiN	3/16	3/8	3/16	2-1/2
83-315AITiN	1/4	3/8	1/4	2-1/2
83-320AITiN	3/8	1/2	3/8	3

#### CUTTING PARAMETERS

Part Number	RPM	Feedrate	Depth of Cut
83-305AITiN	18,000	18 IPM	.012
83-310AITiN	12,000	20 IPM	.020
83-315AITiN	9,000	25 IPM	.030
83-320AITiN	6,010	27 IPM	.045



# Solid Carbide CFRP Drill (Coated)

The CFRP drill is designed to ensure hole quality and diameter. The “W” point of the drill centers the drill to let the peripheral cutting edges shear the material producing a clean, tight tolerance hole without fraying or delamination. The drills are coated with a Diamond Like Carbon (DLC).

**Usage** Carbon Fiber Reinforced Plastics, Kevlar® and Composites

**Material**  See Selection Guide - pg. 2 - 12

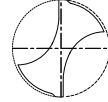

85-800



**NEW**

## FRACTIONAL DRILLS

Part Number	Cutting DIA	LoC	SHK DIA	OAL
85-807	1/8 (0.1250)	0.500	1/8	3
85-808	9/64 (0.1406)	0.500	3/16	3
85-809	5/32 (0.1563)	0.500	3/16	3
85-810	11/64 (0.1719)	0.500	3/16	3
85-811	3/16 (0.1875)	0.500	3/16	3
85-812	13/64 (0.2031)	0.500	1/4	3
85-813	7/32 (0.2188)	0.500	1/4	3
85-814	15/64 (0.2344)	0.500	1/4	3
85-815	1/4 (0.2500)	0.500	1/4	3
85-816	17/64 (0.2656)	0.500	5/16	3
85-817	9/32 (0.2813)	0.500	5/16	3
85-818	19/64 (0.2969)	0.500	5/16	3
85-819	5/16 (0.3125)	0.500	5/16	3
85-820	21/64 (0.3281)	0.500	3/8	3
85-821	11/32 (0.3438)	0.500	3/8	3
85-822	23/64 (0.3594)	0.500	3/8	3
85-823	3/8 (0.3750)	0.500	3/8	3
85-827	7/16 (0.4375)	0.500	7/16	3
85-831	1/2 (0.5000)	0.500	1/2	3

## METRIC DRILLS

Part Number	Cutting DIA	LoC	SHK DIA	OAL
85-961	3.00 (0.1181)	12.000	3	76
85-963	4.00 (0.1575)	12.000	4	76
85-965	5.00 (0.1969)	12.000	5	76
85-967	6.00 (0.2362)	12.000	6	76
85-971	8.00 (0.3150)	12.000	8	76
85-975	10.00 (0.3937)	12.000	10	76
85-979	12.00 (0.4724)	12.000	12	76

## NUMBER DRILLS

Part Number	Cutting DIA	LoC	SHK DIA	OAL
85-876	1 (0.2280)	0.500	1/4	3
85-877	2 (0.2210)	0.500	1/4	3
85-878	3 (0.2130)	0.500	1/4	3
85-879	4 (0.2090)	0.500	1/4	3
85-880	5 (0.2055)	0.500	1/4	3
85-881	6 (0.2040)	0.500	1/4	3
85-882	7 (0.2010)	0.500	1/4	3
85-883	8 (0.1990)	0.500	1/4	3
85-884	9 (0.1960)	0.500	1/4	3
85-885	10 (0.1935)	0.500	1/4	3
85-886	11 (0.1910)	0.500	1/4	3
85-887	12 (0.1890)	0.500	1/4	3
85-888	13 (0.1850)	0.500	3/16	3
85-889	14 (0.1820)	0.500	3/16	3
85-890	15 (0.1800)	0.500	3/16	3
85-891	16 (0.1770)	0.500	3/16	3
85-892	17 (0.1730)	0.500	3/16	3
85-893	18 (0.1695)	0.500	3/16	3
85-894	19 (0.1660)	0.500	3/16	3
85-895	20 (0.1610)	0.500	3/16	3
85-896	21 (0.1590)	0.500	3/16	3

## NUMBER DRILLS (CONT.)

Part Number	Cutting DIA	LoC	SHK DIA	OAL
85-897	22 (0.1570)	0.500	3/16	3
85-898	23 (0.1540)	0.500	5/32	3
85-899	24 (0.1520)	0.500	5/32	3
85-900	25 (0.1495)	0.500	5/32	3
85-901	26 (0.1470)	0.500	5/32	3
85-902	27 (0.1440)	0.500	5/32	3
85-903	28 (0.1405)	0.500	5/32	3
85-904	29 (0.1360)	0.500	5/32	3
85-905	30 (0.1285)	0.500	5/32	3
85-906	31 (0.1200)	0.500	1/8	2-1/2
85-907	32 (0.1160)	0.500	1/8	2-1/2
85-908	33 (0.1130)	0.500	1/8	2-1/2
85-909	34 (0.1110)	0.500	1/8	2-1/2
85-910	35 (0.1100)	0.500	1/8	2-1/2
85-911	36 (0.1065)	0.500	1/8	2-1/2
85-912	37 (0.1040)	0.500	1/8	2-1/2
85-913	38 (0.1015)	0.500	1/8	2-1/2
85-914	39 (0.0995)	0.500	1/8	2-1/2
85-915	40 (0.0980)	0.500	1/8	2-1/2
85-916	41 (0.0960)	0.500	1/8	2-1/2

86-150



**NEW**

## DFC Aerospace Composite Drill (ACD)

Carbon Fiber Reinforced Plastic (CFRP) drills produce a clean tight tolerance hole without fraying or delamination. Top-quality point grind ensures fiber shearing and prevents delamination on hole entry and exit. Enhanced diamond coating to protect cutting edges resulting in less tool changes.

**Usage** Carbon fiber and other composite materials

Part Number	Cutting DIA (inch)	Cutting DIA (mm)	LoC	Shank DIA	OAL
86-152	0.1000	2.54	1	1/4	3
86-154	0.1295	3.29	1	1/4	3
86-156	0.1620	4.11	1	1/4	3
86-158	0.1920	4.88	1	1/4	3
86-160	0.2220	5.64	1	1/4	3
86-162	0.2510	6.38	1	1/4	3
86-164	0.3135	7.96	1	5/16	3
86-166	0.3760	9.55	1	3/8	3
86-168	0.4385	11.14	1	7/16	3
86-170	0.5010	12.73	1	1/2	3

91-000  
91-100



Carbide Tipped

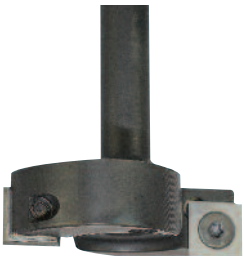

Insert Style

## Spoilboard Surfacing Cutters

Designed for surfacing MDF, particleboard and balsa core where “flow through” or “high flow” fixturing is employed using large capacity vacuum pumps. This method of surfacing spoilboards allows for much faster table planing.

**Usage** Aluminum, plastics and composite wood

**Material** **SP** **HP** **A** **CW**

See Selection Guide - pg. 2 - 12

### STRAIGHT

Part Number	Cutting DIA	SHK DIA	SHK LGTH	# of Flutes
91-000*	1-1/4	1/2	1-1/2	2
91-102	2-1/2	1/2	2	2
91-106	4	3/4	2-1/4	3

\* = Carbide Tipped

Note: 90-002, 90-004, 90-006 & 90-008 use 91-125 insert and 91-130 screw  
90-014 use 91-127 insert and 91-130 screw

### UP-SHEAR

Part Number	Cutting DIA	SHK DIA	SHK LGTH	# of Flutes
91-104	2-1/2	1/2	2	2
91-108	4	3/4	2-1/4	3
91-112 <sup>2</sup>	2-1/2	1/2	2	3
91-114 <sup>2</sup>	4	3/4	2-1/4	3

<sup>2</sup> Radius edges excellent for plastic and aluminum surfacing.

*These tools are dynamically balanced and approved for use on CNC routers. Max RPM 18,000 1/8" Depth of cut MAX.*

*\* DOC = Maximum Depth of Cut Proper running speed for*

- 2-1/2" diameter tools should be fed at 200-600 IPM at 12,000-16,000 RPM.
- 4" diameter tools should be fed at 200-600 IPM at 12,000-14,000 RPM.

*\* Do Not Exceed 1/8" Depth Per Pass*

Part Number	Description
91-125	Insert 10/pk
91-127	Radius Insert 10/pk
91-130	Screw M4 (Old Version)
91-133	Screw M5
91-136	Wrench (T20)

# TAKE IT ON

## Cutting Tool Accessories



LMT Onsrud's mission is to provide cutting tool solutions that exceed our customers' expectations. Many times the solution also includes accessory products, such as cleaners and collets.

## 33-00

### Fiber Adapter Bushing



Used to downsize the bore for smaller shank diameters. Bushings are not recommended for production routing. They should be used only as a temporary substitute for the proper size collet.

**Usage** Temporary collet downsizing

Part Number	OD	Hole	Length
33-01	1/4	1/8	1-1/4
33-02	1/4	3/16	1-1/4
33-03	1/2	1/4	1-1/2
33-04	1/2	5/16	1-1/2
33-05	1/2	3/8	1-1/2

## 33-21

### Cleaning Solvent & Rust Protector



RUST FREE™ is a cleaner designed to provide a simple solution to your collet cleaning needs. Use T-9™ to protect parts from rust and corrosion. Designed to be used after RUST FREE™ – use on collets and tool holders.

## 33-10

### Collet Brush Kit



Part Number	Description
33-10	Collet Brush Kit (Includes 4 Brushes in Tube)
33-15	1/4" Brush
33-16	3/8" Brush
33-17	1/2" Brush
33-18	3/4" Brush
33-19	1" Brush
33-25	Collet Brush Kit (Includes 5 Brushes in Tube)
33-28	Brass Brush

## 33-30

### Tool Extender



Designed to increase the overall reach of 3/8" and smaller router bits. These extensions are used mainly on CNC routers when routing three dimensional parts.

Part Number	EXT OAL	SHK DIA	SHK LGTH	HEAD DIA	COLLET	NUT	WRENCH
33-30	5	3/8	4	1/2	ER8	34-720	34-760
33-32	6-9/16	1/2	5-1/2	5/8	ER11	34-721	34-761
33-34	6-1/4	5/8	5-1/2	5/8	ER11	34-721	34-761
33-36	7	1/2	5-1/2	7/8	ER16	34-722	34-762
33-38	6-9/16	3/4	5-1/2	7/8	ER16	34-722	34-762
33-37	6-5/8	1	5-1/2	1-1/8	ER20	34-723	34-763
33-39	5-1/2	3/4	4	1-3/8	ER25	34-724	34-764

**NOTE:** Tool extenders should be cut off to required length before use.

Extension should not exceed a 4 to 1 ratio. The 4 being the length and the 1 being the diameter. I.E. a 1/2" shank should not extend out over 2" in front of the holder. Recommended Spindle Speed 15,000 to 18,000 RPM.

**33-60**

## Spindle Taper Wiper

Spindle taper wipers are used to ensure clean spindle taper before installing collet chucks into CNC router spindles.

Part Number	TYPE	TOTAL LENGTH	TAPER LENGTH	HANDLE DIA	TAPER MAX DIA
33-60	ISO-30	6-5/8	2-3/8	1	1-1/4
33-62	ISO-40	7-1/2	3-1/16	1	1-3/4
33-64	ISO-50	9-1/2	4-3/4	13/16	2-3/4
33-66	HSK 63F	6-1/2	1-1/4	1	N/A

**33-90**

## HSK 63F Toolholders for CNC Routers

**Note:** Measure the "A" dimension with the collet in the nut.  
Dimensions in Millimeters

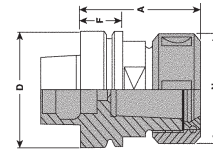

Part Number	DESCRIPTION	D	A	F	N	COLLET NUT	WRENCH
33-90	HSK 50F x ER32 - 80mm	50	80	26	50	34-705	24-757
33-91	HSK 63F x ER40 - 76mm	63	76	26	63	34-706	34-758
33-92	HSK 63F x ER40 - 90mm	63	90	26	63	34-706	34-758
33-93	HSK 63 F x SYOZ 25 - 80mm	63	80	26	60	34-708	34-758
33-94	HSK 63 F x ER32 - 70mm	63	70	26	50	34-705	34-757
33-95	HSK 63 F x ER40 - 125mm	63	125	26	63	34-706	34-758





## Collets | ER Precision Inch

- Standard 0.0004" T.I.R.
- Collapse range: 0.039"

COLLET ID	33-50 ER8	34-60 ER11	34-70 ER16	34-90 ER20	34-150 ER25	34-200 ER32	34-250 ER40	COLLET RANGE
	Part #	Part #	Part #	Part #	Part #	Part #	Part #	
1/16"		34-61	34-71					.043 - 1.062"
3/32"		34-62	34-72	34-92	34-151	34-201		.054 - .093"
1/8"	33-50	34-63	34-73	34-93	34-152	34-202	34-251	.086 - .125"
5/32"		34-64	34-74	34-94	34-153	34-203		.117 - .156"
3/16"		34-65	34-75	34-95	34-154	34-204	34-252	.148 - .187"
7/32"		34-66	34-76	34-96	34-155	34-205		.179 - .218"
1/4"		34-67	34-77	34-97	34-156	34-206	34-253	.211 - .250"
9/32"			34-78	34-98	34-157	34-207		.242 - .281
5/16"			34-79	34-99	34-158	34-208	34-254	.273 - .312"
11/32"			34-80	34-100	34-159	34-209		.304 - .343
3/8"			34-81	34-101	34-160	34-210	34-255	.336 - .375"
13/32"			34-82	34-102	34-161	34-211		.367 - .406"
7/16"				34-103	34-162	34-212	34-256	.398 - .437"
15/32"				34-104	34-163	34-213		.429 - .468"
1/2"				34-105	34-164	34-214	34-257	.461 - .500"
17/32"					34-165	34-215		.492 - .531"
9/16"					34-166	34-216	34-258	.523 - .562"
19/32"					34-167	34-217		.554 - .593"
5/8"					34-168	34-218	34-259	.586 - .625"
21/32"						34-219		.617 - .656"
11/16"						34-220	34-260	.648 - .687"
23/32"						34-221		.679 - .718"
3/4"						34-222	34-261	.711 - .750"
7/8"							34-262	.836 - .875"
1"							34-263	.961 - 1.000"

## 34-50

### Collet Life Plug



Collet plugs are designed to keep full grip collets from collapsing in the back when the router bit shank does not fill the full grip collet completely.

Part Number	Size	Part Number	Size
34-51	1/4	34-54	5/8
34-52	3/8	34-55	3/4
34-53	1/2		

## Collets | ER Precision Metric

- Standard 0.0004" T.I.R.
- Collapse range: 0.039"



COLLET ID	34-300 ER20	34-350 ER25	34-400 ER32	4-450 ER40	INCH	COLLET RANGE
	Part #	Part #	Part #	Part #		
0.5-1					1/32"	.019 - .039"
1-2	34-301	34-351			1/16"	.039 - .079"
2-3	34-302	34-352	34-401		7/64"	.079 - .118"
3-4	34-303	34-353	34-402	34-451	1/8"	.118 - .157"
4-5	34-304	34-354	34-403	34-452	3/16"	.157 - .197"
5-6	34-305	34-355	34-404	34-453	7/32"	.197 - .236"
6-7	34-306	34-356	34-405	34-454	1/4"	.236 - .276"
7-8	34-307	34-357	34-406	34-455	5/16"	.276 - .315"
8-9	34-308	34-358	34-407	34-456	11/32"	.315 - .354"
9-10	34-309	34-359	34-408	34-457	3/8"	.354 - .394"
10-11	34-310	34-360	34-409	34-458	13/32"	.394 - .433"
11-12	34-311	34-361	34-410	34-459	7/16"	.433 - .472"
12-13	34-312	34-362	34-411	34-460	1/2"	.472 - .512"
13-14		34-363	34-412	34-461	17/32"	.512 - .551"
14-15		34-364	34-413	34-462	9/16"	.551 - .591"
15-16		34-365	34-414	34-463	5/8"	.591 - .630"
16-17			34-415	34-464	21/32"	.630 - .669"
17-18			34-416	34-465	11/16"	.669 - .709"
18-19			34-417	34-466	3/4"	.709 - .748"
19-20			34-418	34-467	25/32"	.748 - .787"
20-21				34-468	13/16"	.787 - .827"
21-22				34-469	27/32"	.827 - .866"
22-23				34-470	7/8"	.866 - .906"
23-24				34-471	15/16"	.906 - .945"
24-25				34-472	31/32"	.945 - .984"
25-26				34-473	1"	.984 - 1.024"

## 34-550



## Perske (SYOZ)/DIN6388 Collets and Nuts

Snap collet into the nut before screwing nut onto spindle or collet holder.

SYOZ 20 - L=34 D=20

SYOZ 25 - L=52 D=35

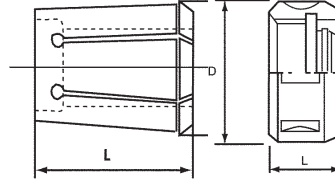

### PERSKE (SYOZ) COLLETS

Collet ID	Part # for SYOZ 20	Part # for SYOZ 25	Collet ID	Part # for SYOZ 20	Part # for SYOZ 25
1/8"	34-551	34-601	5/8"		34-609
3/16"	34-552	34-602	3/4"		34-610
1/4"	34-553	34-603	7/8"		34-611
5/16"	34-554	34-604	1"		34-612
3/8"	34-555	34-605	10 mm	34-558	34-613
7/16"	34-556	34-606	16 mm		34-614
1/2"	34-557	34-607	20 mm		34-615
9/16"		34-608	25 mm		34-616

### PERSKE (SYOZ) NUT

Part # for SYOZ 20	Description	Part # for SYOZ 25	Description
34-707	SYOZ 20 RH Collet Nut	34-715	SYOZ 20 LH Collet Nut
34-708	SYOZ 25 RH Collet Nut	34-716	SYOZ 25 LH Collet Nut

## 34-700



## Ultra High-Speed ER Coated Nuts

Use RH-B nuts for applications where speeds exceed 15,000 RPM's to maintain tool balance. RH-B series nuts are manufactured to the closest tolerance for ultra high speeds. The eccentric ring is perfectly round and all parts of the nut are totally ground.

- Reduce TIR by increasing holding power!
- Increase tool life by up to 20%
- Available for 60,000 rpm spindles

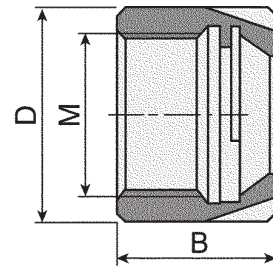

Part Number	Description	D	B	M	Max Speed	Wrench	*Max Torque
34-701	ER RH 11 B Nut	19mm	11.8mm	M14 x 0.75	70,000	34-751	20 ft/lbs
34-702	ER RH 16 B Nut	32mm	18.0mm	M22 x 1.5	65,000	34-754	50 ft/lbs
34-703	ER RH 20 B Nut	35mm	19.5mm	M25 x 1.5	60,000	34-755	75 ft/lbs
34-704	ER RH 25 B Nut	42mm	20.5mm	M32 x 1.5	55,000	34-756	95 ft/lbs
34-705	ER RH 32 B Nut	50mm	23.0mm	M40 x 1.5	50,000	34-757	125 ft/lbs
34-706	ER RH 40 B Nut	63mm	26.0mm	M50 x 1.5	40,000	34-758	140 ft/lbs
34-720	ER 8 Mini Nut	12mm	11.0mm	M10 x 0.75	20,000	34-760	7 ft/lbs
34-721	ER 11 Mini Nut	16mm	12.0mm	M13 x 0.75	20,000	34-761	14 ft/lbs
34-722	ER 16 Mini Nut	22mm	18.0mm	M19 x 1.0	20,000	34-762	22 ft/lbs
34-723	ER 20 Mini Nut	28mm	19.5mm	M24 x 1.0	20,000	34-763	25 ft/lbs
34-724	ER 25 Mini Nut	36mm	21.0mm	M30 x 1.0	20,000	34-764	29 ft/lbs



# TAKE IT ON

## Technical Information



LMT Onsrud has over 70 years of experience routing/machining a wide-range of materials. LMT Onsrud's strengths are extensive engineering resources and technical expertise and service. LMT Onsrud has the deep, solution-based knowledge of how to solve complex problems.

# Technical Data

## TOOL SELECTION

### TOOL MATERIAL

- Solid Carbide: Primarily used in CNC operations. Material provides best rigidity and long tool life.
- Carbide Tipped: Incorporates the wear resistance of carbide and the toughness of a HSS body-mainly hand held.
- HSS: Primarily used in hand routing. Material provides a tough body and sharper cutting edge.
- PCD: Long life in abrasive materials.

### FLUTE GEOMETRY

- Straight flute: Offers a neutral cutting action - highest force.
- Upcut flute: Provides the best surface finish and allows for good chip extraction. May cause part lifting if vacuum or fixturing is not sufficient.
- Downcut flute: Provides a downward force which helps eliminate part lifting. Chip rewelding MAY occur if there is no space below the part for chip expansion.
- Compression: Used for laminated materials, produces a good top and bottom finish on the part.

### NUMBER OF FLUTES

- Single Flute: Allows for larger chiploads in softer materials
- Double Flute: Allows for better part finish in harder materials.
- Multiple Flutes: Allows for an even better part finish in harder materials.

**Note:** As the number of cutting edges increase, your feed rate should increase to prevent burning and premature tool dulling.

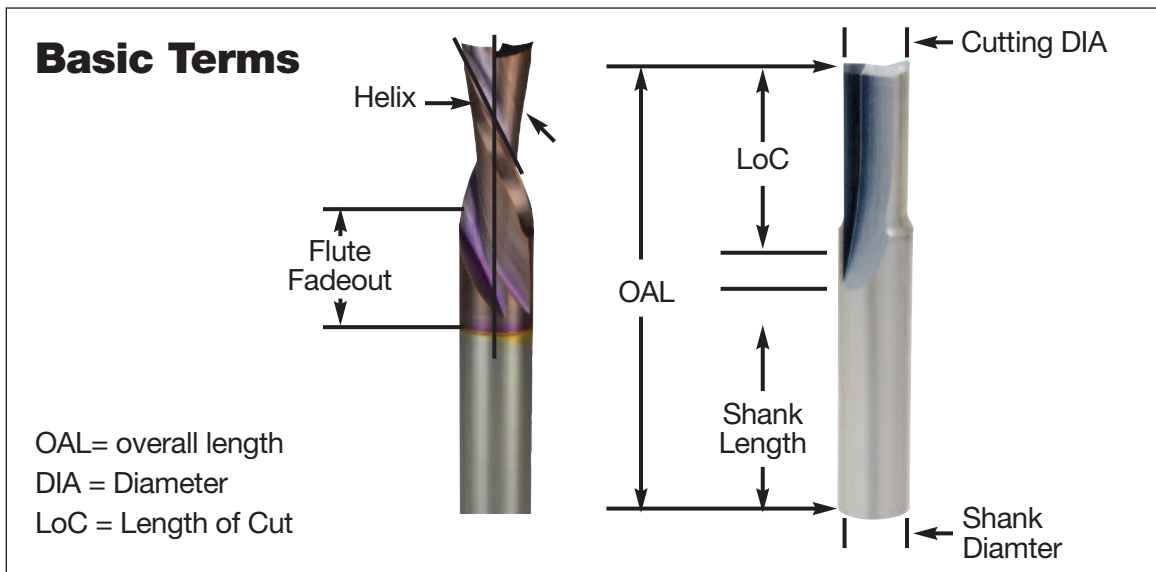

## OPTIMIZING SPEED AND FEEDS

1. Start off using the recommended chipload and RPM for the material you are cutting.
2. Increase the feedrate until the part finish starts to decrease or you risk moving the part off the vacuum. Decrease the feed by 10%.
3. Next decrease your RPM by a set increment until your surface finish deteriorates again. Once this happens increase your RPM until the finish is acceptable.
4. You have now optimized your speed and feed by taking the largest chip possible.

**Note:** This should be done in the first sheet of material to prevent tool dulling due to excessive heat.

### TOOL HEAT

If a feed rate is too low, heat will be generated causing the cutting edge to break down and dull quickly. To check this, run a nest of parts and stop the spindle. When the spindle has stopped rotating, carefully feel the tool's temperature. It should be at or near room temperature. If the tool is hot, review "Optimizing Speed and Feeds".

# Technical Data

## FIXTURING METHODS

### FLOW THROUGH VACUUM

This style uses LDF (Low Density Fiberboard) or MDF (Medium Density Fiberboard) as a sacrificial surface for sheet material to be cut on. The porous nature of LDF or MDF allows vacuum to pass through allowing the material to be held in place for machining. As parts are cut out of the sheet material, vacuum loss starts to occur from the slot produced by the cutting tool. This can lead to part lifting or movement especially in small parts. Cutter diameter will also influence part movement. A 1/2 diameter tool will exert 25% more lateral pressure than a 3/8 diameter tool.

When cutting small parts in sheet material, one may want to consider tab or skin cutting to prevent part movement.

### DEDICATED SPOILBOARD

Dedicated spoilboards are used for reoccurring production runs where optimal cycle times are needed. This work holding method creates vacuum chambers in the sacrificial board specifically to the shape of the parts being cut. This elimination of vacuum loss relates to improved cycle times and part finish.

#### STEPS TO CREATE A DEDICATED SPOILBOARD:

1. Surface both sides of your MDF board.
2. Lay out the part pattern on the MDF and determine quantity that will fit.
3. Cut the part profile into the MDF board using a larger diameter tool than would normally cut the part.  
Make your slot depth 1 to 1.5 times the cutter diameter.
4. A gasket groove must be cut next inside the part profile to create a vacuum seal. The groove should be 1/2 the gasket material thickness to allow for proper compression.
5. A grid pattern must then be cut inside the gasket groove to distribute the vacuum evenly through out the vacuum area.
6. Drill holes throughout the pattern in the intersections of the vacuum grid until there is no resistance on your vacuum gage on the machine table.
7. Seal the board using rubberized coatings, polyurethane sealers or a sanding sealer to prevent vacuum from passing through the board in unwanted areas.
8. Apply the gasket tape.

## Proper Spoilboard Techniques

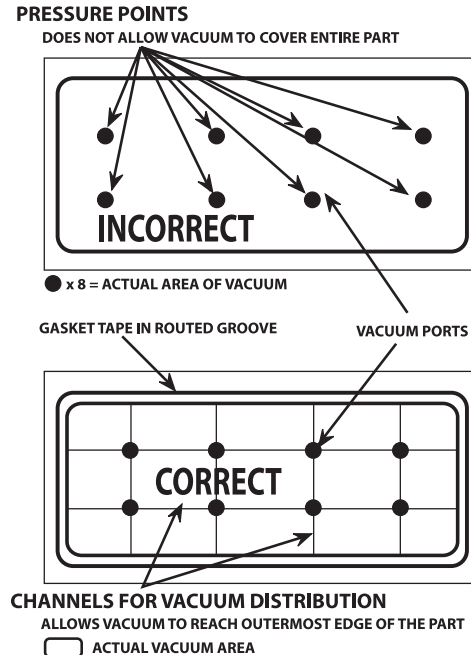

These operations sound time consuming. It will be for your first board. Once you become familiar making these fixtures, you will make up for it in your cycle time reductions and part finish. A lot of headaches and problems can be resolved by using the proper work holding.

### RAISED SPOILBOARD

This is generally used where secondary operations are needed and the spoilboard will interfere with the secondary tool.

Raised spoilboards are another type of fixturing that works well for routing parts such as circles from squares where the scrap or fall off is of such a size to be potentially harmful to the tool and or operator when it is cut free. A raised spoilboard should make sure the fall off would not interfere with the first and second tool and that the fall off would be free and clear of the tool path.

### SURFACING SPOILBOARDS

When creating new fixtures or using a new MDF sheet, the spoilboard must be surfaced to level the board to the machine table. This consists using a large diameter cutter (91-100 series) to quickly level the entire surface.

The following benefits will be achieved by surfacing your spoilboard:

- Leveling material to get consistent cuts.
- Remove grooves caused by routing.
- Reduce vacuum loss due to clogged pores at the material surface due to dust and chips.
- Preventing material warpage caused by humidity.

# Technical Data

## COLLETING

### COLLET LIFE SPAN

Collets have a life span of 3 months if used 8 hours a day. Replacing the collets will ensure your operation runs consistently and prevents tool breakage. When inserting a tool into the collet make sure the flute fadeout does not enter the collet. This will cause run out and potentially lead to tool breakage. To ensure proper clamping, the tool shank should fill, at the minimum, 80% of the depth of the collet. If this can not be achieved, use a collet life plug (34-50 series) to ensure a proper clamping effect.

### COLLET MAINTENANCE

Cleaning is an essential part of collet maintenance. As material is cut it causes the collet, tool holder, collet nut and spindle to become dirty. This causes your tool to cut in an elliptical fashion which will decrease tool life and cause inconsistency in your operation. Collets, tool holder, and collet nut should be cleaned daily using the Rust Free solvent and a brass brush (33-21 and 33-10 series). Refer to the critical areas diagram to see which surfaces must be clean.

### CLEANING INSTRUCTIONS

1. Spray the cleaner on the surface and allow it to soak for a minute.
2. Use a brass brush to clean the surface thoroughly.
3. Rinse off using distilled alcohol. Feel the surface using your fingers to make sure the surface is clean.
4. Apply a small amount of Lubricant T-9 (33-21 series) to prevent rusting.

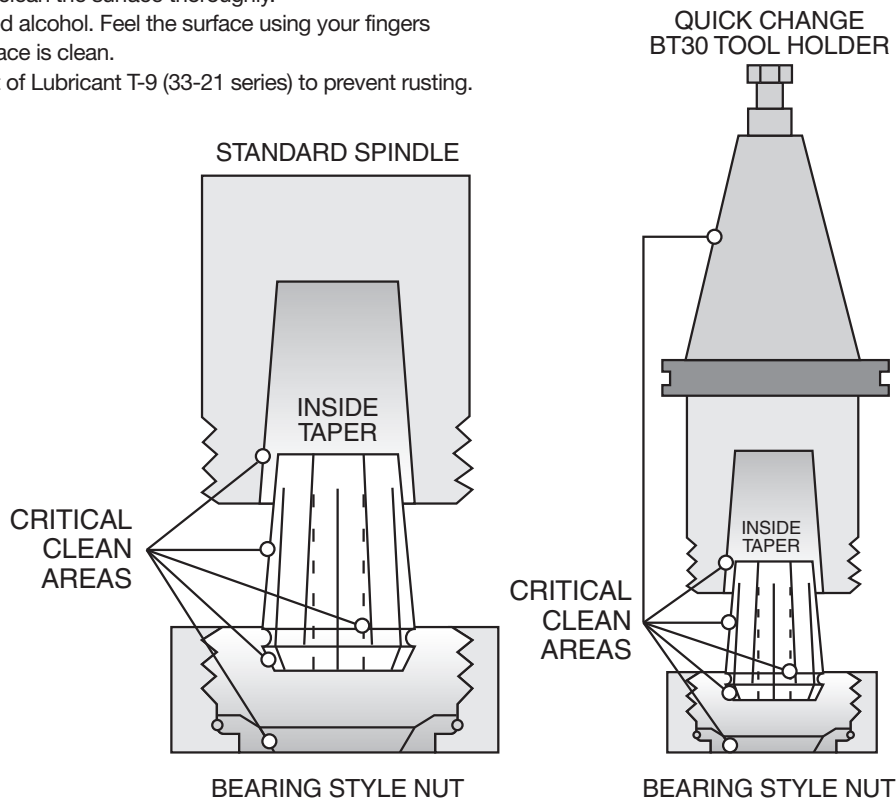

## TOOL BREAKAGE

If a condition arises where multiple tools should break, follow these steps to solve your problem:

1. Are you using the proper tool for the job?
2. Make sure your collets and tool holders are clean and the tool is colleted properly.
3. Check your speed and feed (is your tool hot?)
4. Is your depth of cut too excessive for the material you are cutting?
5. Do you have any part movement?
6. Do you have ample part hold down?
7. Stop running parts and check with your distributor or LMT Onsrud's Technical Support.

If you have to contact your distributor or Technical Support, have the following information:

1. Machine being used.
2. Material being cut.
3. Part number of tool along with the batch number which is below the part number etched on shank of tool.
4. Speed / Feed / Depth of cut.
5. Where did the tool break (flute, shank, or in the collet)?
6. How long did the tool work before it broke?
7. Have you done this operation in the past using this tool?

# Honeycomb Technical Data Sheets

29-000	HONEYCOMB CORE	ALUMINUM		NOMEX		PAPER	
	Part #	RPM	Feed Rate	RPM	Feed Rate	RPM	Feed Rate
	29-003 (1/4")	500-4,000	100 IPM	500-10,000	120 IPM	500-10,000	120 IPM
	29-006 (3/8")	500-4,000	100 IPM	500-10,000	120 IPM	500-10,000	120 IPM
	29-009 (1/2")	500-4,000	100 IPM	500-10,000	120 IPM	500-10,000	120 IPM
	29-012 (5/8")	500-4,000	100 IPM	500-10,000	120 IPM	500-10,000	120 IPM
	29-015 (3/4")	500-4,000	100 IPM	500-10,000	120 IPM	500-10,000	120 IPM

29-050	SPINDLE SPEED		CORE TYPE	Max Feed Rate	SPINDLE SPEED		29-100
	DIA	Max RPM			Feed Rate	Max RPM	
	1/4	25,000	NR	Aluminum, less than 5#/cuft	100	25,000	1/4
	3/8	25,000	NR	Aluminum, More than 5#/cuft	100	25,000	3/8
	1/2	25,000	800	Paper based	400	25,000	1/2
	3/4	25,000	800	Paper, based w/Fiber Reinforcement	800	25,000	3/4
	1	25,000	800	Fiberglass	600		
	1-1/2	18,000	800	Phenolic	600		
	1-3/4	18,000	NR	Carbon Fiber	800		
	2	16,500	100	Aramid, less than 5#/cuft	800		
	2-1/2	15,000	100	Aramid, More than 5#/cuft	800		
	3	14,000					
	4	12,000					

30-000/ 30-300 30-700 32-200	FEEDS & SPEEDS	MAX FEED RATES				SPINDLE SPEED	
	Core Type	Solid Carbide	Solid Carbide w/Teeth	Diamond Saw	HSS	DIA	MAX RPM
	Aluminum, Less than 5#/cuft	100	100	NR	150	1/4	25,000
	Aluminum, More than 5#/cuft	100	100	NR	100	3/8	25,000
	Paper based	400	400	NR	250	1/2	25,000
	Paper, based with Fiber Reinforcement	800	800	400	150	3/4	25,000
	Fiberglass	600	600	600	NR	1	25,000
	Phenolic	200	200	400	NR	1-1/2	18,000
	Carbon Fiber	NR	NR	800	NR	1-3/4	18,000
	Aramid, Less than 5#/cuft	800	800	400	150	2	16,500
	Aramid, More than 5#/cuft	800	800	400	NR	2-1/2	15,000
						3	14,000
						4	12,000

Note: 30-300 assembly requires one (1) hogger and one (1) blade

31-000/ 32-000	FEEDS & SPEEDS	FEED RATES						SPINDLE SPEED	
	Core Type	Solid Carbide	Diamond Plated	HSS Saw	HSS Wavy	HSS (31-000)	HSS (31-100)	DIA	MAX RPM
	Aluminum, Less than 5#/cuft	100	NR	150	100	100-140	90-140	3/8	25,000
	Aluminum, More than 5#/cuft	100	NR	100	100	70	70	1/2	25,000
	Paper based	300	NR	200	300	50	50	3/4	25,000
	Paper, based w/Fiber Reinforcement	400	300	600	300	100-150	100-150	1	25,000
	Fiberglass	NR	600	NR	NR	NR	NR	1-1/2	25,000
	Phenolic	NR	600	NR	NR	NR	NR	1-3/4	25,000
	Carbon Fiber	NR	800	NR	NR	NR	NR	2	18,000
	Aramid, Less than 5#/cuft	200	NR	150	200	100-150	100-150	2-1/2	18,000
	Aramid, More than 5#/cuft	200	400	NR	NR	NR	NR	3	18,000

34-000	Core Type	Cutter	RPM	Feed Rate	Cut Direction
	Fiberglass panels with paper core (Nomex®)	Diamond Grit	18,000	220 lpm	Conventional
	Aluminum panels with aluminum core	HSS Saw	16,000	120 lpm	Conventional



# Soft Wood Cutting Data

APPLICATION	GOOD	BETTER	BEST
Single Pass	52-200/57-200	60-300/60-350	60-100C
Roughing	52-200/57-200	60-800/60-900	60-000
Finishing		60-300/60/350	60-200

**DEPTH OF CUT:** 1 x D Use recommended chip load  
 2 x D Reduce chip load by 25%  
 3 x D Reduce chip load by 50%

## CHIP LOAD PER TOOTH

		Cutting Edge Diameter																					
Series	Cut	1/16	3/32	1/8	5/32	3/16	7/32	1/4	5/16	3/8	7/16	1/2	9/16	5/8	3/4	7/8	1	1 1/8	1 1/4	1 1/2	1 3/4	2	
10-00	1 x D	.004-.006	.004-.006	.005-.007				.007-.009		.008-.010													
37-00/ 37-20	Varies							.004-.006															
37-50	1/2 CED						.003-.006	.003-.006		.003-.006													
37-60	1/2 CED									.004-.006					.006-.008		.008-.010						
37-80	Varies																.004-.006		.004-.006*			.004-.006**	
40-50	1 1/2											.003-.005											
40-000	1 x D		.002-.004	.002-.004	.003-.005			.004-.006	.004-.006	.005-.007													
40-100	1 x D		.005-.007		.005-.007	.005-.007	.005-.007	.006-.008	.006-.008	.007-.009		.008-.010				.010-.012							
52-200/ 57-200	1 x D		.006-.008	.006-.008	.006-.008	.006-.008	.006-.008	.007-.009	.007-.009	.008-.010	.008-.010	.009-.011	.009-.011	.010-.012	.011-.013								
52-700	1 x D		.006-.008		.008-.010			.009-.011		.010-.012		.011-.013		.012-.013	.013-.015		.016-.018						
57-200MD	1 x D							.009-.011		.010-.012		.011-.013											
52-400/ 57-400	1 x D				.006-.008	.006-.008		.007-.009	.007-.009	.008-.010		.009-.011											
52-900	1 x D							.007-.009		.008-.010		.009-.011											
56-200	1 x D		.004-.006	.004-.006	.005-.007	.005-.007	.005-.007	.006-.008	.006-.008	.007-.009		.008-.010			.010-.012								
57-900	1 x D							.007-.009		.008-.010		.009-.011											
60-000 (LH)	1 x D									.013-.015		.015-.017		.017-.019	.019-.021								
60-000 (HH)	1 x D									.016-.018		.018-.020		.020-.022	.022-.024								
60-090	1 x D													.005-.007									
60-100MW	1 x D		.011-.013		.013-.015		.018-.020	.020-.022		.022-.024		.022-.024		.024-.026	.026-.028								
60-100DC	1 x D							.020-.022		.022-.024		.022-.024											
60-100C	1 x D							.024-.026		.026-.028		.026-.028		.028-.030	.030-.032								
60-100MC	1 x D							.019-.021		.021-.023		.021-.023											
60-100PLR	1 x D							.021-.023		.023-.025		.023-.025											
60-200	1 x D						.005-.007	.006-.008		.007-.009		.008-.010			.008-.010								
60-300	1 x D							.024-.026		.026-.028		.026-.028		.028-.030	.030-.032								
60-350	1 x D							.017-.019		.019-.021		.019-.021			.021-.023								
60-500/ 500M	1 x D									.015-.017		.015-.017		.017-.019	.019-.021								
60-600	1 x D											.019-.021		.019-.021	.023-.025								
60-700	1 x D											.019-.021		.021-.023	.023-.025								
60-800	1 x D								.017-.019		.017-.019		.019-.021	.021-.023	.023-.025								
60-900	1 x D								.017-.019		.017-.019		.018-.020										
60-950	1 x D								.024-.026		.024-.026		.026-.028										
61-000	1 x D		.008-.010	.008-.010	.009-.011	.009-.011	.010-.012	.010-.012	.011-.013	.011-.013	.011-.013	.012-.014											
61-200	1 x D		.008-.010				.010-.012	.010-.012	.011-.013	.011-.013	.012-.014												
63-200	1 x D		.003-.005				.005-.007																
64-000/ 65-000	1 x D	.001-.003		.002-.004		.003-.006		.004-.006		.005-.007													
68-100	1 x D									.014-.015		.015-.016											
77-100	1 x D		.003-.005					.005-.007															

\* = 16,000 RPM  
 \*\* = 15,000 RPM

**FORMULAS:** Chip Load = Feed Rate / (RPM x # of cutting edges)  
 Feed Rate (IPM) = RPM x # of cutting edges x chip load  
 Speed (RPM) = Feed Rate / (# of cutting edges x chip load)

**DEFINITIONS:** IPM = Inches Per Minute



# Hard Wood Cutting Data

APPLICATION	GOOD	BETTER	BEST
Single Pass	52-200/57-200	60-300/60-350	60-100C
Roughing	52-200/57-200	60-800/60-900	60-000
Finishing		60-300/60/350	60-200

**DEPTH OF CUT:** 1 x D Use recommended chip load  
 2 x D Reduce chip load by 25%  
 3 x D Reduce chip load by 50%

## CHIP LOAD PER TOOTH

		Cutting Edge Diameter																						
Series	Cut	1/16	3/32	1/8	5/32	3/16	7/32	1/4	5/16	3/8	7/16	1/2	9/16	5/8	3/4	7/8	1	1 1/8	1 1/4	1 1/2	1 3/4	2		
12-00	1 x D			.002-.004	.002-.004		.003-.005	.003-.005		.004-.006	.005-.007	.005-.007				.010-.012								
37-00/ 37-20	Varies							.004-.006																
37-50	1/2 CED					.003-.006		.003-.006		.003-.006									.008-.010					
37-60	1/2 CED									.004-.006					.006-.008			.008-.010						
37-80	Varies																.004-.006		.004-.006*			.004-.006**		
40-50	1 1/2											.003-.005												
40-000	1 x D			.006-.008	.006-.008	.007-.009		.008-.010	.008-.010	.009-.007		.010-.012												
40-100	1 x D			.004-.006		.005-.007	.005-.007	.005-.007	.006-.008	.006-.008		.007-.009			.009-.011									
48-000	1 x D					.004-.006		.005-.007	.005-.007	.005-.007		.006-.008			.007-.009	.008-.010	.009-.011	.009-.011	.010-.012	.011-.013	.012-.014	.013-.015	.014-.016	.015-.017
52-200/ 57-200	1 x D			.003-.005	.003-.005	.004-.006	.004-.006	.005-.007	.005-.007	.006-.008	.006-.008	.007-.009	.007-.009	.008-.010	.009-.011									
52-700	1 x D			.002-.004		.003-.005		.004-.006		.005-.007		.006-.008		.007-.009	.008-.010		.009-.011							
57-200MD	1 x D							.009-.011		.010-.012		.011-.013												
52-400/ 57-400	1 x D				.004-.006	.004-.006		.005-.007	.005-.007	.006-.008		.007-.009												
52-900	1 x D							.006-.008		.007-.009		.007-.009												
56-200	1 x D			.003-.005	.003-.005	.004-.006	.004-.006	.005-.007	.005-.007	.006-.008		.007-.009			.009-.011									
57-900	1 x D							.005-.007		.006-.008		.007-.009												
60-000 (LH)	1 x D									.013-.015		.014-.016		.016-.018	.017-.019									
60-000 (HH)	1 x D									.015-.017		.017-.019		.019-.021	.021-.023									
60-090	1 x D													.005-.007										
60-100MV	1 x D			.010-.012		.012-.014		.014-.016		.016-.018		.018-.020		.020-.022	.022-.024									
60-100C	1 x D									.019-.021		.021-.023		.023-.025	.025-.027									
60-100DC	1 x D									.019-.021		.021-.023												
60-100MC	1 x D									.019-.021		.021-.023												
60-100PLR	1 x D									.021-.023		.023-.025												
60-300	1 x D									.024-.026		.026-.028		.028-.030	.030-.032									
60-500/ 500M	1 x D											.013-.015		.015-.017	.016-.018									
60-600	1 x D											.018-.020			.022-.024									
60-700	1 x D											.018-.020		.020-.022	.022-.024									
60-800	1 x D									.017-.019		.019-.021		.021-.023	.023-.025									
60-900	1 x D									.015-.017		.017-.019		.019-.021										
60-950	1 x D									.019-.021		.021-.023												
61-200	1 x D			.007-.009				.009-.011	.009-.011	.010-.012														
63-200	1 x D			.003-.005				.005-.007																
64-000/ 65-000	1 x D	.001-.003		.002-.004		.003-.005		.004-.006		.005-.007														
68-100	1 x D									.010-.012		.011-.013		.012-.014	.013-.015									
77-100	1 x D			.003-.005				.005-.007																

\* = 16,000 RPM  
 \*\* = 15,000 RPM

**FORMULAS:** Chip Load = Feed Rate / (RPM x # of cutting edges)  
 Feed Rate (IPM) = RPM x # of cutting edges x chip load  
 Speed (RPM) = Feed Rate / (# of cutting edges x chip load)

**DEFINITIONS:** IPM = Inches Per Minute

APPLICATION	GOOD	BETTER	BEST
Single Pass	52-200/57-200	60-100MW	60-100MC
Roughing		60-800	60-000
Finishing			60-200

**DEPTH OF CUT:** 1 x D Use recommended chip load  
 2 x D Reduce chip load by 25%  
 3 x D Reduce chip load by 50%

**CHIP LOAD PER TOOTH**

		Cutting Edge Diameter																					
Series	Cut	1/16	3/32	1/8	5/32	3/16	7/32	1/4	5/16	3/8	7/16	1/2	9/16	5/8	3/4	7/8	1	1 1/8	1 1/4	1 1/2	1 3/4	2	
37-00/ 37-20	Varies							.004-.006															
37-50	1/2 CED					.003-.006		.003-.006		.003-.006													
37-60	1/2 CED									.004-.006		.004-.006			.006-.008		.008-.010						
37-80	Varies																.004-.006		.004-.006*			.004-.006**	
40-50	1 1/2											.003-.005											
47-00	1 x D															.004-.006			.004-.006	.004-.006			
48-000	1 x D					.004-.006		.005-.007	.005-.007	.005-.007		.006-.008		.006-.008	.007-.009	.008-.010	.009-.011						
52-200/ 57-200	1 x D			.005-.007	.005-.007	.006-.008	.006-.008	.006-.008	.006-.008	.007-.009	.007-.009	.008-.010	.008-.010	.009-.011	.009-.011								
57-200MD	1 x D							.009-.011		.010-.012		.011-.013											
52-400/ 57-400	1 x D				.003-.005	.004-.006		.005-.007	.005-.007	.006-.008		.008-.010	.009-.011	.010-.012	.011-.013	.012-.014							
52-900	1 x D							.006-.008		.007-.009		.008-.010							.009-.011				
56-200	1 x D			.003-.005	.003-.005	.004-.006	.004-.006	.005-.007	.005-.007	.006-.008		.007-.009			.009-.011								
57-900	1 x D							.006-.008		.007-.009		.008-.010											
60-000 (LH)	1 x D									.012-.014		.013-.015		.014-.016	.016-.018								
60-000 (HH)	1 x D									.017-.019		.018-.020		.020-.022	.023-.025								
60-090	1 x D													.004-.006									
60-100MW	1 x D			.010-.012		.010-.012		.013-.015		.014-.016		.016-.018	.018-.020	.020-.022	.023-.025								
60-100C	1 x D									.017-.019		.018-.020		.020-.022	.023-.025								
60-100DC	1 x D									.017-.019		.018-.020											
60-100MC	1 x D									.019-.021		.021-.023											
60-100PLR	1 x D									.021-.023		.023-.025											
60-200	1 x D							.004-.006		.005-.007		.005-.007			.006-.008								
60-300	1 x D									.017-.019		.018-.020		.020-.022	.023-.025								
60-350	1 x D									.014-.016		.016-.018		.017-.019	.019-.021								
60-500/ 500M	1 x D											.014-.016		.016-.018	.018-.020								
60-600	1 x D											.020-.022		.022-.024	.024-.026								
60-700	1 x D											.020-.022		.022-.024	.024-.026								
60-800	1 x D									.017-.019		.019-.021		.021-.023	.023-.025								
60-900	1 x D									.017-.019		.019-.021											
60-950	1 x D									.017-.019		.018-.020											
61-200	1 x D			.007-.009		.008-.010		.009-.011	.009-.011	.010-.012		.011-.013											
62-200	1 x D			.010-.012		.011-.013		.012-.014	.012-.014	.013-.015		.014-.016											
63-200	1 x D			.003-.005				.005-.007															
64-000/ 65-000	1 x D	.001-.003		.002-.004		.003-.005		.004-.006		.005-.007													
68-100	1 x D									.008-.010		.012-.014		.015-.017	.018-.020								
77-100	1 x D			.003-.005				.005-.007															

91-000/91-100 - See Page 73 for Technical Information

\* = 16,000 RPM  
 \*\* = 15,000 RPM

**FORMULAS:** Chip Load = Feed Rate / (RPM x # of cutting edges)  
 Feed Rate (IPM) = RPM x # of cutting edges x chip load  
 Speed (RPM) = Feed Rate / (# of cutting edges x chip load)

**DEFINITIONS:** IPM = Inches Per Minute





# Soft Plywood Cutting Data

APPLICATION	GOOD	BETTER	BEST
Single Pass	60-100MW	60-100C	60-100MC
Roughing		60-800	60-000

**DEPTH OF CUT:** 1 x D Use recommended chip load  
 2 x D Reduce chip load by 25%  
 3 x D Reduce chip load by 50%

## CHIP LOAD PER TOOTH

		Cutting Edge Diameter																			
Series	Cut	1/16	1/8	5/32	3/16	7/32	1/4	5/16	3/8	7/16	1/2	9/16	5/8	3/4	7/8	1	1-1/8	1-1/4	1-1/2	2	
37-00/ 37-20	Varies						.004-.006														
37-50	1/2 CED				.003-.006		.003-.006		.003-.006												
37-60	1/2 CED								.004-.006		.004-.006			.006-.008		.008-.010					
37-80	Varies															.004-.006		.004-.006*		.004-.006**	
40-50	1 1/2										.003-.005										
48-000	1 x D				.005-.007		.005-.007	.006-.008	.006-.008		.007-.009		.008-.010	.009-.011	.010-.012	.011-.013	.012-.014	.013-.015			
56-200	1 x D		.003-.005	.003-.005	.004-.006	.004-.006	.005-.007	.005-.007	.006-.008		.007-.009			.009-.011							
57-200MD	1 x D						.009-.011				.010-.012			.011-.013							
60-000 (LH)	1 x D								.014-.016		.016-.018		.018-.020	.020-.022							
60-000 (HH)	1 x D								.017-.019		.019-.021		.021-.023	.023-.025							
60-090	1 x D												.003-.005								
60-100MW	1 x D		.013-.015		.014-.016		.017-.019		.019-.021		.021-.023		.023-.025	.025-.027							
60-100C	1 x D								.022-.024		.024-.026		.026-.028	.028-.030							
60-100DC	1 x D								.019-.021		.021-.023										
60-100MC	1 x D								.019-.021		.021-.023										
60-100PLR	1 x D								.021-.023		.023-.025										
60-300	1 x D								.022-.024		.024-.026		.026-.028	.028-.030							
60-350	1 x D								.020-.022		.022-.024		.024-.026	.026-.028							
60-500/ 500M	1 x D										.021-.023		.023-.025	.025-.027							
60-600	1 x D										.028-.030		.030-.032	.032-.034							
60-700	1 x D										.028-.030		.030-.032	.032-.034							
60-800	1 x D								.017-.019		.019-.021		.021-.023	.023-.025							
60-900	1 x D								.017-.019		.019-.021										
60-950	1 x D								.022-.024		.024-.026										
63-200	1 x D		.003-.005				.005-.007														
61-200	1 x D		.006-.008		.007-.009		.008-.010	.008-.010	.009-.011		.010-.012										
64-000/ 65-000	1 x D	.001-.003	.002-.004		.003-.005		.004-.006		.005-.007												
68-100									.010-.012		.012-.014		.017-.019	.018-.020							

\* = 16,000 RPM  
 \*\* = 15,000 RPM

**FORMULAS:** Chip Load = Feed Rate / (RPM x # of cutting edges)  
 Feed Rate (IPM) = RPM x # of cutting edges x chip load  
 Speed (RPM) = Feed Rate / (# of cutting edges x chip load)

**DEFINITIONS:** IPM = Inches Per Minute

APPLICATION	GOOD	BETTER	BEST
Single Pass	60-100MW	60-100C	60-100MC
Roughing		60-800	60-000

**DEPTH OF CUT:** 1 x D Use recommended chip load  
 2 x D Reduce chip load by 25%  
 3 x D Reduce chip load by 50%

## CHIP LOAD PER TOOTH

		Cutting Edge Diameter																					
Series	Cut	1/16	3/32	1/8	5/32	3/16	7/32	1/4	5/16	3/8	7/16	1/2	9/16	5/8	3/4	7/8	1	1 1/8	1 1/4	1 1/2	1 3/4	2	
37-00/ 37-20	Varies							.004-.006															
37-50	1/2 CED					.003-.006		.003-.006		.003-.006													
37-60	1/2 CED									.004-.006		.004-.006			.006-.008			.008-.010					
37-80	Varies																.004-.006		.004-.006*				.004-.006**
40-50	1 1/2											.003-.005											
48-000	1 x D					.004-.006		.005-.007	.005-.007	.006-.008		.007-.009		.008-.010	.009-.011	.010-.012	.011-.013	.012-.014	.013-.015				
56-200	1 x D			.003-.005	.003-.005	.004-.006	.004-.006	.005-.007	.005-.007	.006-.008		.007-.009			.009-.011								
57-200MD	1 x D						.009-.011		.010-.012		.011-.013												
60-000 (LH)	1 x D									.014-.016		.016-.018		.018-.020	.020-.022								
60-000 (HH)	1 x D									.017-.019		.019-.021		.021-.023	.023-.025								
60-090	1 x D													.003-.005									
60-100MW	1 x D			.012-.014		.012-.014		.014-.016		.016-.018		.018-.020		.020-.022	.022-.024								
60-100C	1 x D									.019-.021		.021-.023		.023-.025	.025-.027								
60-100DC	1 x D									.019-.021		.021-.023											
60-100MC	1 x D									.019-.021		.021-.023											
60-100PLR	1 x D									.021-.023		.023-.025											
60-300	1 x D									.019-.021		.021-.023		.023-.025	.025-.027								
60-350	1 x D									.018-.020		.020-.022		.022-.025	.024-.026								
60-600	1 x D											.027-.029		.030-.032	.032-.034								
60-700	1 x D											.027-.029		.029-.031	.032-.034								
60-800	1 x D									.017-.019		.019-.021		.021-.023	.023-.025								
60-900	1 x D									.017-.019		.019-.021											
60-950	1 x D									.019-.021		.021-.023											
61-200	1 x D			.005-.007				.007-.009	.007-.009	.008-.010		.009-.011											
63-200	1 x D			.003-.005				.005-.007															
64-000/ 65-000	1 x D	.001-.003		.002-.004		.003-.005		.004-.006		.005-.007													
68-100	1 x D									.010-.012		.012-.014		.017-.019	.018-.020								

\* = 16,000 RPM  
 \*\* = 15,000 RPM

**FORMULAS:** Chip Load = Feed Rate / (RPM x # of cutting edges)  
 Feed Rate (IPM) = RPM x # of cutting edges x chip load  
 Speed (RPM) = Feed Rate / (# of cutting edges x chip load)

**DEFINITIONS:** IPM = Inches Per Minute



# Laminated Chipboard Cutting Data

APPLICATION	GOOD	BETTER	BEST
Single Pass	60-100MW	60-100MC	60-100PLR

## CHIP LOAD PER TOOTH

		Cutting Edge Diameter															
Series	Cut	1/8	3/16	7/32	1/4	5/16	3/8	1/2	9/16	5/8	3/4	7/8	1	1-1/8	1-1/4	1-1/2	2
37-00/ 37-20	Varies				.004-.006												
37-50	1/2 CED		.003-.006		.003-.006		.003-.006										
37-60	1/2 CED						.004-.006		.004-.006			.006-.008		.008-.010			
37-80	Varies												.004-.006		.004-.006		.004-.006
48-000	1 x D		.005-.007	.005-.007	.006-.008	.006-.008	.007-.009	.008-.010		.009-.011	.010-.012	.011-.013	.012-.014	.013-.015	.014-.016		
60-100MW	1 x D	.013-.015	.014-.016		.017-.019		.019-.021	.021-.023		.025-.027	.027-.029						
60-100C	1 x D						.022-.024	.024-.026		.026-.028	.028-.030						
60-100DC	1 x D						.019-.021	.021-.023									
60-100MC	1 x D						.019-.021	.021-.023									
60-100PLR	1 x D						.021-.023	.023-.025									
60-600	1 x D							.028-.030		.030-.032	.032-.034						
68-100	1 x D						.008-.010	.012-.014		.016-.018	.019-.021						

\* = 16,000 RPM

\*\* = 15,000 RPM

**FORMULAS:** Chip Load = Feed Rate / (RPM x # of cutting edges)  
 Feed Rate (IPM) = RPM x # of cutting edges x chip load  
 Speed (RPM) = Feed Rate / (# of cutting edges x chip load)

**DEFINITIONS:** IPM = Inches Per Minute



# Laminated Plywood Cutting Data

DEPTH OF CUT: Greater than 3 x D, reduce chip load by 25%

APPLICATION	GOOD	BETTER	BEST
Single Pass	60-100MW	60-100MC	60-100PLR

## CHIP LOAD PER TOOTH

		Cutting Edge Diameter																					
Series	Cut	1/16	3/32	1/8	5/32	3/16	7/32	1/4	5/16	3/8	7/16	1/2	9/16	5/8	3/4	7/8	1	1 1/8	1 1/4	1 1/2	1 3/4	2	
37-00/ 37-20	Varies							.004-.006															
37-50	1/2 CED					.003-.006		.003-.006		.003-.006													
37-60	1/2 CED									.004-.006		.004-.006				.006-.008		.008-.010					
37-80	Varies																.004-.006		.004-.006				.004-.006
48-000	1 x D					.004-.006	.005-.007	.005-.007	.006-.008	.006-.008		.007-.009		.009-.011	.010-.012	.011-.013	.012-.014	.013-.015	.014-.016				
60-100MW	1 x D			.013-.015		.014-.016		.015-.017		.016-.018		.018-.020		.019-.021	.021-.023								
60-100C	1 x D									.019-.021		.021-.023		.023-.025	.025-.027								
60-100DC	1 x D									.019-.021		.021-.023											
60-100MC	1 x D									.019-.021		.021-.023											
60-100PLR	1 x D									.021-.023		.023-.025											
60-600	1 x D											.027-.029		.030-.032	.032-.034								
68-100	1 x D									.008-.010		.012-.014		.016-.018	.019-.021								

\* = 16,000 RPM  
 \*\* = 15,000 RPM

**FORMULAS:** Chip Load = Feed Rate / (RPM x # of cutting edges)  
 Feed Rate (IPM) = RPM x # of cutting edges x chip load  
 Speed (RPM) = Feed Rate / (# of cutting edges x chip load)

**DEFINITIONS:** IPM = Inches Per Minute



# Soft Plastic Cutting Data

## < 1/2" DIAMETER TOOL

APPLICATION	GOOD	BETTER	BEST
Single Pass	61-000P	65-000	63-750
Roughing			60-000

**DEPTH OF CUT:** 1 x D Use recommended chip load  
 2 x D Reduce chip load by 25%  
 3 x D Reduce chip load by 50%

## > 3/8" DIAMETER TOOL

APPLICATION	GOOD	BETTER	BEST
Single Pass	56-600	52-600	52-700
Roughing			60-000

## CHIP LOAD PER TOOTH

		Cutting Edge Diameter																					
Series	Cut	1/16	3/32	1/8	5/32	3/16	7/32	1/4	5/16	3/8	7/16	1/2	9/16	5/8	3/4	7/8	1	1 1/8	1 1/4	1 1/2	1 3/4	2	
10-00	1 x D	.002 - .004		.004 - .006		.006 - .008		.006 - .008		.007 - .009		.008 - .010											
37-00/ 37-20	Varies							.004-.006															
37-50*	1 x D					.003 - .006		.003 - .006		.003 - .006													
37-60*	1 x D									.004 - .006		.004 - .006			.006 - .008		.008 - .010						
37-80	Varies																.001 - .003		.001 - .003				.001 - .003
52-200B/BL	1 x D	.002 - .004		.002 - .004		.004 - .006		.004 - .006		.004 - .006		.006 - .008		.010 - .012	.012 - .014								
52-400	1 x D			.002 - .004		.003 - .005		.004 - .008		.005 - .007		.006 - .008		.007 - .009									
52-600	1 x D							.008 - .010		.010 - .012		.012 - .014		.014 - .016	.016 - .018								
52-700	1 x D											.012 - .014		.014 - .016	.016 - .018								
56-430	1 x D			.006 - .008		.006 - .008		.007 - .009		.008 - .010		.009 - .011											
56-600	1 x D			.004 - .006		.006 - .008		.008 - .010		.010 - .012		.012 - .014											
57-600	1 x D							.008 - .010		.010 - .012		.012 - .014		.014 - .016	.016 - .018								
60-000	1 x D									.004 - .006		.006 - .008		.008 - .012	.012 - .016								
60-200	1 x D							.004 - .006		.004 - .006		.006 - .010			.012 - .016								
60-900	1 x D									.004 - .006		.006 - .008											
61-000P	1 x D			.004 - .006		.006 - .008		.008 - .012		.014 - .018		.018 - .022											
61-400	1 x D			.017 - .019		.017 - .019		.018 - .020		.019 - .021		.020 - .021											
62-750	1 x D			.004 - .006		.006 - .008		.008 - .012		.008 - .012		.010 - .014											
62-850	1 x D			.004 - .006		.006 - .008		.008 - .012		.008 - .012		.010 - .014											
63-500	1 x D	.002 - .004		.004 - .006		.005 - .007		.006 - .008		.007 - .009													
63-750	1 x D	.002 - .004		.004 - .006		.006 - .008		.008 - .012		.008 - .012		.010 - .014											
63-850	1 x D	.002 - .004		.004 - .006		.006 - .008		.008 - .012		.008 - .012		.010 - .014											
64-000/ 65-000	1 x D	.002 - .004		.004 - .006		.006 - .008		.008 - .012		.008 - .012													
65-200B/ 65-300B	1 x D	.002-.003		.002-.003		.003-.004		.003-.005	.003-.005	.004-.006		.006-.008											
66-000	1 x D							.004 - .008		.004 - .008		.004 - .008											
66-200	1 x D							.004 - .006		.006 - .008													
66-300	1 x D			.002 - .004				.004 - .006		.006 - .008		.006 - .008											
66-350	1 x D			.002 - .004				.004 - .006		.006 - .008		.006 - .008											
77-100 (DE)	1 x D			.005 - .007																			
77-100 (SE)	1 x D							.008 - .010															

\* = 12,500 RPM

**NOTE:** To eliminate rewelding increase the feedrate or change to a single edge tool.  
 If using a downcut spiral and chip rewelding occurs, cut a slot in your spoilboard to allow the chips a place to expand.  
 Incorrect chiploads can lead to knife marks occurring.

**FORMULAS:** Chip Load = Feed Rate / (RPM x # of cutting edges)  
 Feed Rate = RPM x # of cutting edges x chip load  
 Speed (RPM) = Feed Rate / (# of cutting edges x chip load)

**DEFINITIONS:** IPM = Inches Per Minute



# Hard Plastic Cutting Data

## < 1/2" DIAMETER TOOL

APPLICATION	GOOD	BETTER	BEST
Single Pass	56-000P	65-000	63-700
Roughing			60-000
Finishing		60-200	75-100

**DEPTH OF CUT:** 1 x D Use recommended chip load  
 2 x D Reduce chip load by 25%  
 3 x D Reduce chip load by 50%

## > 3/4" DIAMETER TOOL

APPLICATION	GOOD	BETTER	BEST
Single Pass	56-000P	52-600	60-200
Roughing			60-000
Finishing			60-200

## CHIP LOAD PER TOOTH

		Cutting Edge Diameter																					
Series	Cut	1/16	3/32	1/8	5/32	3/16	7/32	1/4	5/16	3/8	7/16	1/2	9/16	5/8	3/4	7/8	1	1 1/8	1 1/4	1 1/2	1 3/4	2	
37-00/ 37-20	Varies							.004-.006															
37-50*	1 x D					.003-.006		.003-.006		.003-.006													
37-60*	1 x D									.004-.006		.004-.006			.006-.008		.008-.010						
37-80	Varies																.001-.003		.001-.003				.001-.003
52-200B/BL	1 x D	.002-.004		.002-.004		.004-.006		.004-.006		.004-.006		.006-.008		.008-.010	.010-.012								
52-600	1 x D							.006-.008		.008-.010		.010-.012		.012-.014	.014-.016								
56-000P	1 x D			.002-.004		.004-.006		.004-.006		.006-.008		.008-.010											
56-430	1 x D			.005-.007		.005-.007		.006-.008		.007-.009		.008-.010											
56-450	1 x D					.005-.007		.006-.008		.007-.009		.008-.010											
56-600	1 x D			.003-.005		.005-.007		.007-.009		.009-.011		.011-.013											
57-600	1 x D							.006-.008		.008-.010		.010-.012		.012-.014	.014-.016								
60-000	1 x D									.004-.006		.006-.008		.008-.012	.012-.016								
60-200	1 x D							.004-.006		.004-.006		.006-.010			.012-.016								
60-900	1 x D									.004-.006		.006-.008											
61-000P	1 x D			.003-.005		.005-.007		.007-.011		.013-.017		.017-.021											
61-400	1 x D			.014-.016		.014-.016		.015-.017		.016-.018		.017-.019											
62-700	1 x D			.006-.008		.008-.010		.010-.012		.010-.012		.012-.016											
62-750	1 x D			.004-.006		.006-.008		.008-.012		.008-.012		.010-.014											
62-800	1 x D			.006-.008		.008-.010		.010-.012		.010-.012		.012-.016											
62-850	1 x D			.004-.006		.006-.008		.008-.012		.008-.012		.010-.014											
63-500	1 x D	.002-.004		.003-.005		.003-.005		.004-.006		.005-.007													
63-700	1 x D	.002-.004		.006-.008		.008-.010		.010-.012		.010-.012		.012-.016											
63-750	1 x D	.002-.004		.004-.006		.006-.008		.008-.012		.008-.012		.010-.014											
63-800	1 x D	.002-.004		.006-.008		.008-.010		.010-.012		.010-.012		.012-.016											
63-850	1 x D	.002-.004		.004-.006		.006-.008		.008-.012		.008-.012		.010-.014											
64-000/ 65-000	1 x D	.002-.004		.006-.008		.008-.010		.010-.012		.010-.012													
66-000	1 x D							.004-.008		.004-.008		.004-.008											
66-200	1 x D									.004-.006		.006-.008											
66-300	1 x D			.002-.004				.004-.006		.006-.008		.006-.008											
66-350	1 x D			.002-.004				.004-.006		.006-.008		.006-.008											
77-000	1 x D	.002-.004		.002-.004		.006-.008		.008-.012															
77-100 (DE)	1 x D			.005-.007																			
77-100 (3E)	1 x D							.008-.010															

91-100 - See Page 73 for Technical Information

**NOTE:** When chip rewelding occurs while cutting soft plastic, increase feedrate or go to a single edge tool. Incorrect chiploads can result in cratering.

**FORMULAS:** Chip Load = Feed Rate / (RPM x # of cutting edges)  
 Feed Rate (IPM) = RPM x # of cutting edges x chip load  
 Speed (RPM) = Feed Rate / (# of cutting edges x chip load)

**DEFINITIONS:** IPM = Inches Per Minute



# Composite Cutting Data

APPLICATION	GOOD	BETTER	BEST
Carbon Fiber Reinforced Plastic (CFRP) - Slotting	66-800	68-200	66-500
Carbon Fiber Reinforced Plastic (CFRP) - Semi-Finishing (up to 30% RDOC)	66-500	66-775	66-750
Carbon Fiber Reinforced Plastic (CFRP) - Finishing (up to 10% RDOC)	68-000	66-750	66-700
Single Pass Solution	66-775	66-500	68-300
Fiberglass - G10, G11	66-500	68-200	68-300
Glass Reinforced Plastic (GRP)	54-200	66-500	66-800
Phenolic	66-900	67-200	67-220

**DEPTH OF CUT:** 1 x D Use recommended chip load  
 2 x D Reduce chip load by 25%  
 3 x D Reduce chip load by 50%

## CHIP LOAD PER TOOTH

		Cutting Edge Diameter																					
Series	Cut	1/16	3/32	1/8	5/32	3/16	7/32	1/4	5/16	3/8	7/16	1/2	9/16	5/8	3/4	7/8	1	1 1/8	1 1/4	1 1/2	1 3/4	2	
52-000	1xD			.003-.005		.003-.005		.004-.006		.006-.008		.010-.012											
54-000 / 59-000	1xD			.002-.004		.002-.004		.002-.004		.003-.006		.005-.010											
54-200	1xD			.002-.004		.002-.004		.002-.004		.003-.006		.005-.010											
54-300	1xD									.007-.009		.008-.010											
55-000 / 58-000	1xD			.002-.004		.002-.004		.002-.004		.003-.006		.007-.009											
55-300	1xD									.007-.009		.008-.010											
56-000P	1xD			.002-.004		.002-.004		.004-.006		.004-.006		.004-.006											
56-450	1xD					.002-.005		.003-.005	.003-.006	.004-.006		.005-.007											
57-000	1xD			.003-.005		.003-.005		.004-.006		.006-.008		.010-.012											
63-000	1xD			.003-.005		.003-.005		.003-.005	.004-.006			.005-.007											
66-500	1xD			.001-.003		.001-.003		.004-.006		.004-.006		.005-.007											
66-700	1xD							.0001-.0003		.0002-.0004		.0003-.0005											
66-750	1xD							.0001-.0003		.0002-.0004		.0003-.0005											
66-775	1xD							.0005-.0010		.0007-.0015		.0010-.0020											
66-800	1xD							.001-.002		.002-.003		.003-.004											
66-900	1xD			.002-.004		.002-.004		.004-.006		.004-.006		.006-.008											
67-000	1xD							.004-.006		.004-.006		.004-.006											
67-200	1xD									.002-.010		.002-.010											
67-220*	1xD									.001-.002		.001-.002											
67-250	1xD			.002-.004				.004-.006		.004-.006													
67-300	1xD							.004-.006		.006-.008		.010-.012											
67-400	1xD			.002-.004				.004-.006		.004-.006		.004-.006											
67-500	1xD			.001-.003		.001-.003		.002-.004	.002-.004	.003-.005		.004-.006											
67-600	1xD			.002-.004		.002-.004		.003-.005	.003-.005	.004-.006		.005-.007											
68-000*	1xD							.004-.006		.004-.006		.004-.006				.008-.010							
68-200*	1xD							.0005-.001		.001-.002		.001-.002											
68-300*	1xD									.001-.002						.004-.006							

**NOTE:** \*Spindle RPM's generally range from 12,000 - 16,000 for PCD tools when cutting composite materials.

Consider 66-500, 66-900, 67-000, 67-250, 67-500 series tools as a single flute in speed & feed rate calculations.

**FORMULAS:** Chip Load = Feed Rate / (RPM x # of cutting edges)  
 Feed Rate (IPM) = RPM x # of cutting edges x chip load  
 Speed (RPM) = Feed Rate / (# of cutting edges x chip load)

**DEFINITIONS:** IPM = Inches Per Minute

### RECOMMENDED STARTING RPMs

DIA	RPM
1/8-3/16	10,000-12,000
1/4	8,000-10,000
3/8	6,000-8,000
1/2	4,000-6,000



# Aluminum Cutting Data

APPLICATION	GOOD	BETTER	BEST
<b>BLOCK</b>			
Single Pass	63-600	AMC 2 Flute	AMC 3 Flute
Roughing	AMC 2 Flute	AMC 3 Flute	AMC Rougher
Finishing		66-300	AMC
Slotting	63-600	AMC 2 Flute	AMC 3 Flute
Profile/Shape		52-200B	AMC
<b>SHEET</b>			
Single Pass	61-000	65-000	63-600
<b>EXTRUSION</b>			
Single Pass	63-600	81-000	81-100

**DEPTH OF CUT:** 1 x D Use recommended chip load  
 2 x D Reduce chip load by 25%  
 3 x D Reduce chip load by 50%

To view our complete line of **AMC Tools**, reference our **Milling Tools Catalog** which is available at [www.onsrud.com](http://www.onsrud.com)

## CHIP LOAD PER TOOTH

		Cutting Edge Diameter																					
Series	Cut	1/16	3/32	1/8	5/32	3/16	7/32	1/4	5/16	3/8	7/16	1/2	9/16	5/8	3/4	7/8	1	1 1/8	1 1/4	1 1/2	1 3/4	2	
37-00/37-20	Varies							.004-.006															
37-80	Varies																.001-.003		.001-.003				.001-.003
40-000*	1 x D			.005-.007		.005-.007		.006-.008	.006-.008	.007-.009		.008-.010											
40-100	1 x D			.001-.003		.001-.003		.002-.004	.002-.004	.003-.005		.004-.008			.006-.008								
52-000	1 x D			.003-.005		.003-.005		.004-.006		.006-.008		.010-.012											
52-200B/BL	1 x D	.002-.004		.003-.005		.003-.005		.004-.006		.006-.008		.010-.012		.012-.014	.014-.016								
57-000*	1 x D			.003-.005		.003-.005		.004-.006		.006-.008		.010-.012											
61-000	1 x D			.001-.003		.002-.005		.002-.005		.003-.007		.007-.009											
62-600	1 x D	.002-.004		.002-.004		.003-.006		.003-.006	.003-.006	.004-.008		.008-.010											
63-000	1 x D			.006-.008		.006-.008		.007-.009	.007-.009	.008-.010		.009-.011											
63-600	1 x D	.002-.004		.002-.004		.003-.006		.003-.006	.003-.006	.004-.008		.008-.010											
63-900	1 x D	.002-.004		.002-.004		.003-.006		.003-.006	.003-.006	.004-.008		.008-.010											
64-000/65-000	1 x D	.002-.004		.002-.004		.003-.006		.003-.006		.004-.008													
66-200	1 x D							.004-.006		.006-.008													
66-300	1 x D			.002-.004				.004-.006		.006-.008		.006-.008											
66-350	1 x D			.002-.004				.004-.006		.006-.008		.006-.008											
77-025	1 x D	.002-.004		.002-.004		.003-.006		.003-.006															
77-100				.002-.004				.003-.005															
81-000	1 x D								.004-.006	.004-.006													
81-100	1 x D								.002-.005	.003-.008		.003-.008											

\* 16,000 RPM  
 \*\* Aluminum Extrusion or Aluminum UAD Doors/Windows

**NOTE:** When cutting soft aluminum a squirt of cutting fluid every now and then will help to eliminate chip rewelding and improve surface finish.

**FORMULAS:** Chip Load = Feed Rate / (RPM x # of cutting edges)  
 Feed Rate (IPM) = RPM x # of cutting edges x chip load  
 Speed (RPM) = Feed Rate / (# of cutting edges x chip load)

**DEFINITIONS:** IPM = Inches Per Minute





**DEPTH OF CUT:** 1 x D Use recommended chip load  
 2 x D Reduce chip load by 25%  
 3 x D Reduce chip load by 50%

## CHIP LOAD PER TOOTH

		Cutting Edge Diameter															
Series	Cut	1/16	3/32	1/8	5/32	3/16	7/32	1/4	5/16	3/8	7/16	1/2	9/16	5/8	3/4	7/8	1
37-50	1xD					.003 - .006		.003 - .006		.003 - .006							
37-60	1xD									.004 - .006		.004 - .006			.006 - .008		.008 - .010
52-000	1xD			.003 - .006		.003 - .006		.004 - .006		.008 - .010		.012 - .014					
52-200B/BL	1xD	.002 - .004		.002 - .004		.002 - .004		.004 - .006		.004 - .006		.006 - .008		.008 - .010	.010 - .012		
52-400	1xD			.002 - .004		.002 - .004		.003 - .005		.004 - .006		.005 - .007					
52-600	1xD							.004 - .006		.006 - .008		.008 - .010		.008 - .010	.010 - .012		
52-700				.002 - .004		.003 - .005		.004 - .006		.005 - .007		.006 - .008		.007 - .009	.008 - .010		.009 - .011
56-000P	1xD			.002 - .004		.002 - .004		.004 - .006		.006 - .008		.008 - .010					
56-450	1xD			.002 - .004		.002 - .004		.003 - .005		.004 - .006		.005 - .007					
57-000	1xD			.002 - .004		.002 - .004		.003 - .005		.004 - .006		.005 - .007					
57-200	1xD			.002 - .004		.002 - .004		.003 - .005		.004 - .006		.005 - .007		.006 - .008	.007 - .009		
57-400	1xD			.002 - .004		.002 - .004		.003 - .005		.004 - .006		.005 - .007		.006 - .008	.007 - .009		
57-600	1xD							.004 - .006		.006 - .008		.008 - .010		.008 - .010	.010 - .012		
60-200	1xD							.002 - .004		.002 - .006		.002 - .006		.004 - .008			
62-700	1xD			.002 - .004		.004 - .006		.006 - .010		.006 - .010		.010 - .012					
62-750	1xD			.002 - .004		.004 - .006		.006 - .010		.006 - .010		.010 - .012					
62-800	1xD			.002 - .004		.004 - .006		.006 - .010		.006 - .010		.010 - .012					
62-850	1xD			.002 - .004		.004 - .006		.006 - .010		.006 - .010		.010 - .012					
63-700	1xD	.002 - .003		.002 - .004		.004 - .006		.006 - .010		.006 - .010		.010 - .012					
63-750	1xD	.002 - .003		.002 - .004		.004 - .006		.006 - .010		.006 - .010		.010 - .012					
63-800	1xD	.002 - .003		.002 - .004		.004 - .006		.006 - .010		.006 - .010		.010 - .012					
63-850	1xD	.002 - .003		.002 - .004		.004 - .006		.006 - .010		.006 - .010		.010 - .012					
64-000/ 65-000	1xD	.002 - .004		.006 - .008		.008 - .010	.010 - .012	.010 - .012		.010 - .012							
66-000	1xD							.002 - .004		.003 - .005		.004 - .006					

**FORMULAS:** Chip Load = Feed Rate / (RPM x # of cutting edges)  
 Feed Rate (IPM) = RPM x # of cutting edges x chip load  
 Speed (RPM) = Feed Rate / (# of cutting edges x chip load)

**DEFINITIONS:** IPM = Inches Per Minute

## Drilling Cutting Data

Drill Diameter																	
Series		SFM	3	1/8	3/16	5	6	1/4	5/16	8	3/8	7/16	1/2	5/8	3/4	7/8	1
67-800	Composites	230		.001 - .003	.001 - .003			.002 - .004	.002 - .004		.003 - .005	.003 - .005	.003 - .005				
68-900	Composites	230		.001				.0015			.0015		.0015				
70-500	Plastic	200		.019 - .021				.021 - .023			.023 - .025		.025 - .027	.027 - .029	.029 - .031	.031 - .033	.033 - .035
72-000*	Wood		.009 - .011			.011 - .013	.013 - .015			.015 - .017							
85-800	Composites	230		.0005	.0005			.001	.001		.001	.001	.001				
86-100	Composites	165		.001				.0015			.0015		.0015				
86-150	Composites	150 - 250		.001	.001			.0015			.0015		.0015				

\* Gang drills run at 4,500 RPM and 150 IPM

**FORMULAS:** RPM = (3.82 x SFM) / tool dia.  
Feedrate (IPM) = RPM x IPR

**DEFINITIONS:**  
IPM = Inches Per Minute  
IPR = Inches Per Revolution

## Foam Cutting Data

**DEPTH OF CUT:** 1 x D Use recommended chip load  
2 x D Reduce chip load by 25%  
3 x D Reduce chip load by 50%

### CHIP LOAD PER TOOTH

Material: Foam

Cutting Edge Diameter																							
Series	Cut	1/16	3/32	1/8	5/32	3/16	7/32	1/4	5/16	3/8	7/16	1/2	9/16	5/8	3/4	7/8	1	1 1/8	1 1/4	1 1/2	1 3/4	2	
40-550	1 x D											.004 - .006											
48-000	1 x D			.002 - .004		.002 - .004		.003 - .005	.003 - .005	.004 - .006		.005 - .007		.006 - .008	.007 - .009		.010						.010 - .012
52-550	1 x D			.002 - .004		.002 - .004		.004 - .006	.004 - .006	.004 - .006													
52-700	1 x D			.002 - .004		.002 - .004		.004 - .006	.004 - .006	.004 - .006		.005 - .007		.006 - .008	.007 - .009		.010						

# MODIFICATIONS MODIFICATION FORM

DISTRIBUTOR \_\_\_\_\_ DATE \_\_\_\_\_  
 DISTRIBUTOR NUMBER \_\_\_\_\_ TOOL TO BE MODIFIED (PART NUMBER) \_\_\_\_\_  
 DISTRIBUTOR PO NUMBER \_\_\_\_\_ QUANTITY \_\_\_\_\_  
 SALES ORDER NUMBER \_\_\_\_\_  
 FORM COMPLETED BY \_\_\_\_\_

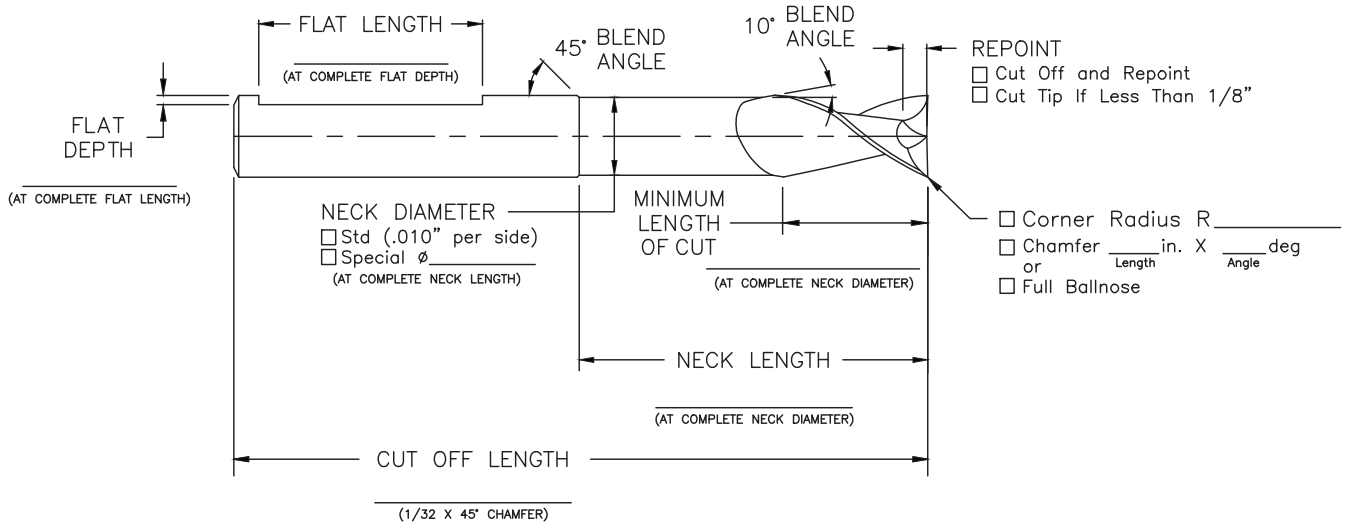

NOTES: \_\_\_\_\_  
 \_\_\_\_\_  
 \_\_\_\_\_  
 \_\_\_\_\_

### Tool Modification Instructions

- Complete form
- Fax to Onsrud with purchase order number.
- You will receive a confirmation fax
- Any modifications over 5 pieces will be treated as a special tool.

### TOOL MODIFICATION

Part Number	Description
BALLNOSE	RADIUS: _____
RADIUS	DIAMETER: _____
CHAMFER	CUT OFF AND CHAMFER
CUT-REPOINT	CUT OFF TIP AND REPOINT
CUT-TIP	CUT OFF TIP UNDER 1/8
*ERL/SPNBCK	CEL RQD: _____ DIA: _____
FLAT	FLATS ON SHANK
REPOINT-1/8	REPOINT LESS THAN 1/8"

# CUTTING TOOL QUOTE REQUEST FORM

1081 S. Northpoint Blvd. • Waukegan, Illinois 60085 • Phone (847) 362-1560 • Fax (800) 557-6720 • www.onsrud.com

\*Starred Items = Required information

\*Distributor Name \_\_\_\_\_ \*Distributor's Reference Number \_\_\_\_\_

\*Distributor Address \_\_\_\_\_

\*Contact \_\_\_\_\_ \*Email Address \_\_\_\_\_

\*Telephone \_\_\_\_\_ \*Fax \_\_\_\_\_

End User Name \_\_\_\_\_ Customer Reference Number \_\_\_\_\_

End User Address \_\_\_\_\_

Contact \_\_\_\_\_ Email Address \_\_\_\_\_

Telephone \_\_\_\_\_ Fax \_\_\_\_\_

\*Material being machined \_\_\_\_\_ Hardness \_\_\_\_\_

Machine type (Check all that apply):  CNC Router  CNC Mill  Inverted  Air Router  Hand  Other

If other, describe \_\_\_\_\_

H.P.= \_\_\_\_\_

Max. Spindle Speed \_\_\_\_\_ Coolant Type \_\_\_\_\_

\*Tool Material:  HSS  Solid Carbide  Carbide Tip  Powder Metal  PCD Full Face  PCD Tip  Other

If other, describe \_\_\_\_\_

\*Flute Style:  Spiral Up  Spiral "O" Up  Straight "V" Flute  Compression  
 Spiral Down  Spiral "O" Down  Straight "O" Flute  Morise Compression

\*Flute Form:  Rougher  Chipbrk/Finisher  Finisher  Other

\*Point Geometry:  Square  Ball Nose  Drill Point  Other  
 Center Cutting  Non-Center Cutting

\*If other, describe \_\_\_\_\_

\*Tool Similar To: \_\_\_\_\_

Number of Flutes \_\_\_\_\_

Cutting Diameter (CED) \_\_\_\_\_

Cutting Length (LoC) \_\_\_\_\_

Shank Diameter (SHK) \_\_\_\_\_

Overall Length (OAL) \_\_\_\_\_

Neck Diameter (ND) \_\_\_\_\_

Neck Radius (NL) \_\_\_\_\_

Corner Radius (CR) \_\_\_\_\_

Coolant Through  Yes  No

Transition Grind Needed \_\_\_\_\_

Flat  Yes  No What Type? \_\_\_\_\_

Coating  Yes  No Specify: \_\_\_\_\_

If other, describe \_\_\_\_\_

\*Quantities Needed: \_\_\_\_\_

Minimum is 6 pieces

Any Target Pricing? \_\_\_\_\_

Distributor / End User? \_\_\_\_\_

Additional Notes: \_\_\_\_\_

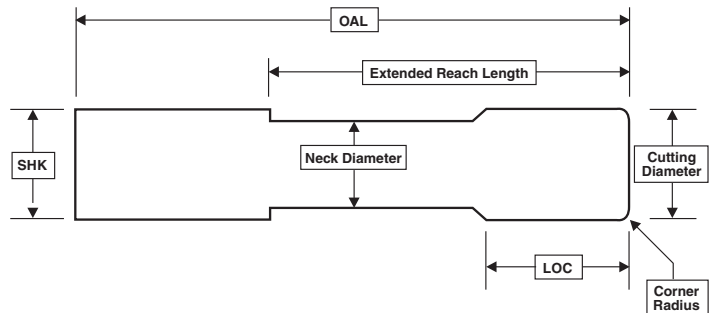

# Cutting Tool Design

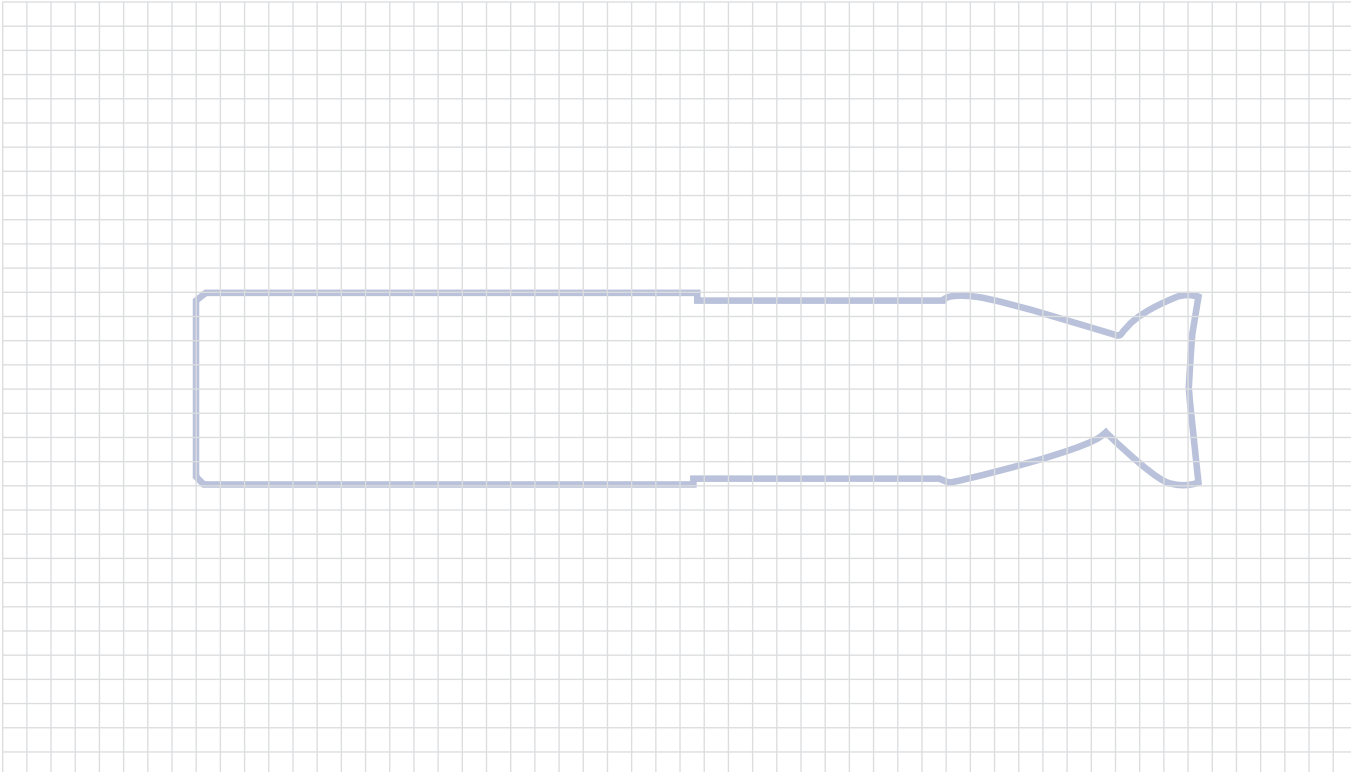
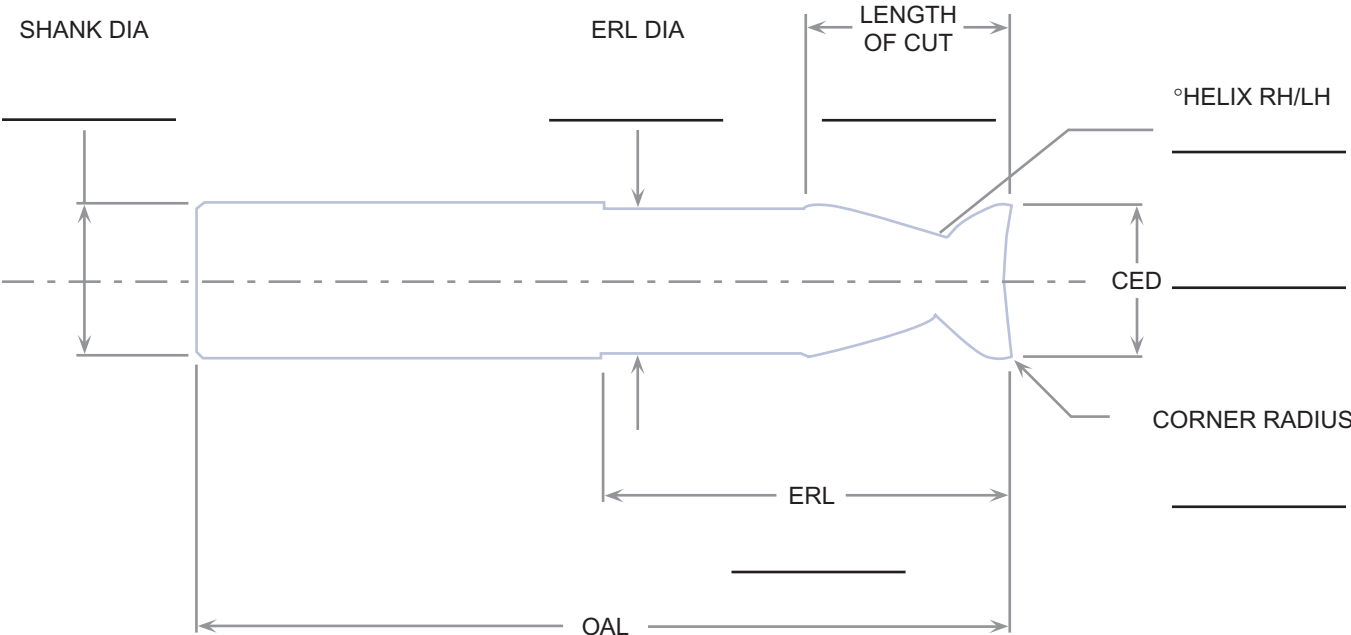

**To Access Our Complete Range of Cutting Tool Solutions,  
Contact Us to Receive Our Other Catalogs**

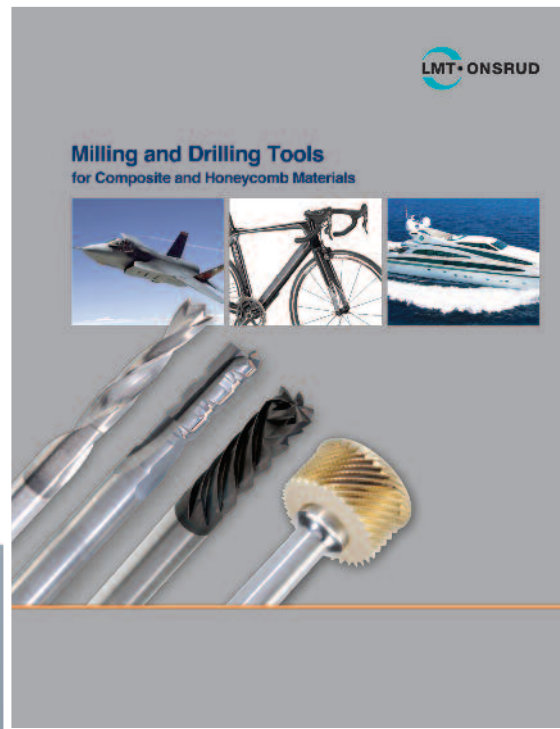

## LMT Onsrud Terms & Conditions

**Shipping** - F.O.B. Waukegan, IL. All shipments ground unless otherwise specified.

**Claims** – Any claims for shortage, damage or loss must be made within 30 days of invoice date. United Parcel Service is a preferred method of shipment because of reliability and ease of tracing problem shipments.

**Guarantee** - Our products are guaranteed against defects in material and quality of manufacture when used in the proper manner. If tools are returned and found to be defective, we will repair or replace the tools. Continued tool breakage caused by improper tool usage without the knowledge of LMT Onsrud's technical staff is not a condition for return and replacement of such tools.

**Errors** - LMT Onsrud, LP cannot be held responsible for incorrect parts made with our products due to mislabeling or defect.

**Return Goods Policy** – No merchandise can be returned without prior authorization. Credit will not be issued for merchandise returned without a return authorization number. Product must be a current revision catalog item in new and saleable condition. All returns subject to a 15% restocking fee or offsetting order of equal value.

**Specials** - LMT Onsrud, LP has the right to over or under ship by 10% all specials. Special orders less than 10 pieces are subject to +/- 1 piece. Specials and modified tools are not returnable for credit. Specials cancelled will be assessed an in-process charge based on the status of the order and expenses incurred at the time of cancellation. If a special tool has been completed, the tool will be shipped and the price quoted will be billed.

**Safety Precautions** – Cutting tools should only be used to perform operations that are compatible with the original tool design. Safety glasses and other appropriate safety equipment should be worn by all people in the vicinity of tool use.

**Prices & Terms** - All prices and terms are subject to change without notice. All orders are subject to acceptance at LMT Onsrud.



**LMT Onsrud LP**  
1081 S. Northpoint Blvd.  
Waukegan, IL 60085 USA  
Toll Free: + 1 800 234 1560  
Direct: + 1 847 362 1560  
[www.onsrud.com](http://www.onsrud.com)

**ISO 9001 Certified**



**LMT Tool Systems GmbH**  
Heidenheimer Straße 84  
73447 Oberkochen  
Germany  
Phone +49 73 64 95 79-0  
Fax +49 73 64 95 79-80 00  
[lmt.de@lmt-tools.com](mailto:lmt.de@lmt-tools.com)  
[www.lmt-tools.com](http://www.lmt-tools.com)

Distributed By:

Printed in USA/Catalog OC-17

**LMT BELIN S.A.S.**  
01590 Lavancia  
France  
Phone +33 474 758989  
Fax +33 474 758990  
[info@lmt-belin.com](mailto:info@lmt-belin.com)  
[www.lmt-belin.com](http://www.lmt-belin.com)

**LMT KIENINGER GmbH**  
Vogesenstraße 23  
77933 Lahr  
Germany  
Phone +49 7821 943-0  
Fax +49 7821 943213  
[info@lmt-kieninger.com](mailto:info@lmt-kieninger.com)  
[www.lmt-kieninger.com](http://www.lmt-kieninger.com)

LMT Technology Group

**BELIN  
FETTE  
KIENINGER  
ONSRUD**

**LMT FETTE Werkzeugtechnik GmbH & Co. KG**  
Grabauer Straße 24  
21493 Schwarzenbek  
Germany  
Phone +49 4151 12-0  
Fax +49 4151 3797  
[info@lmt-fette.com](mailto:info@lmt-fette.com)  
[www.lmt-fette.com](http://www.lmt-fette.com)

**LMT ONSRUD LP**  
1081 S. Northpoint Blvd.  
Waukegan, Illinois 60085  
USA  
Phone +1 847 362 1560  
Fax +1 800 557 6720  
[info@onsrud.com](mailto:info@onsrud.com)  
[www.onsrud.com](http://www.onsrud.com)