



TOOL HOLDERS





HAIMER

- Family owned & operated since 1977
- Global Headquarters located in Igenhausen Germany
- North America operation and stocking facility located near Chicago, Illinois
- Manufacturer of Tool Holders, Shrink Fit machines, Balancing Machines and Precision Measuring Instruments

Tool Holders

- Available in all tapers and sizes for CAT, BT, HSK, Makino F80, Capto and SK: Shrink Fit chucks, ER collet chucks, HG High Precision collet chucks and facemill arbors
- Pre-balanced to G2.5 specifications and have the capability to be fine balanced
- Conform to the strict AT3 taper tolerance
- Manufactured with the utmost precision and quality

Balancing Machines

- Allows you to balance tool holders, grinding wheels and facemill cutters
- Can help you to correct to unbalance by drilling & milling or by using balancing rings and weights (such as set screws).
- Balancing systems will accommodate all spindle tapers and sizes for CAT, BT, HSK, Makino F80, Capto and SK

Shrink Fit Machines

- Whether it's our economical "Power Clamp Nano" or the "Power Clamp Preset" with tool presetting capabilities, HAIMER has a wide range of models & options to suit your needs.
- Heating system & cooling system are manually operated and completely independent of each other, which will provide versatility and ease of use.
- Capability to shrink carbide and HSS cutting tools & extensions with shank diameters ranging from 1/8" to 2" (3mm to 50mm)

Precision Measuring Instruments

- Allows you to find your part edge in X, Y or Z. Making calculations based on the ball diameter are no longer necessary
- Will check the flatness of a surface or find the center of a bore or shaft, with no calculations necessary.

TABLE OF CONTENTS

Introduction

Application guideline _____ 4
 Shrink Fit Chuck features _____ 6
 ER Collet Chuck features _____ 8
 Power Series features _____ 10
 Evolution of Shrink fit Chuck _____ 12
 Evolution of ER Collet Chuck _____ 14
 Power Collet Chuck features _____ 16
 Safe-Lock™ features _____ 18
 Cool-Jet features _____ 20
 Cool Flash features _____ 21
 Heavy Duty Chucks _____ 22
 HG Mini Extensions & Torque Master _____ 23

CAT 40/ASME B5.50

Shrink Fit Chuck _____ 26
 Power Shrink Chuck _____ 27
 Power Mini Shrink Chuck _____ 28
 Power Collet Chuck _____ 29
 ER Collet Chuck _____ 30
 Face Mill Arbor _____ 31

CAT 50/ASME B5.50

Shrink Fit Chuck _____ 33
 Power Shrink Chuck _____ 34
 Heavy Duty Chuck _____ 35
 Power Collet Chuck _____ 36
 ER Collet Chuck _____ 37
 Face Mill Arbor _____ 38

BT 30/JIS B 6339

Shrink Fit Chuck _____ 40
 Power Mini Shrink Chuck _____ 41
 Power Collet Chuck _____ 42
 ER Collet Chuck _____ 43
 Face Mill Arbor _____ 44

BT 40/JIS B 6339

Shrink Fit Chuck _____ 45
 Power Shrink Chuck _____ 47
 Power Mini Shrink Chuck _____ 48
 Power Collet Chuck _____ 49
 ER Collet Chuck _____ 50
 HG Collet Chuck _____ 52
 Face Mill Arbor _____ 53
 Adapter for morse taper _____ 54

BT 50/JIS B 6339

Shrink Fit Chuck _____ 56
 Power Shrink Chuck _____ 57
 Heavy Duty Chuck _____ 58
 Power Collet Chuck _____ 59
 ER Collet Chuck _____ 60
 HG Collet Chuck _____ 61
 Face Mill Arbor _____ 62
 Adapter for morse taper _____ 63
 Blank Adapter _____ 65

HSK-A 32/40/50 DIN 69893-1

HSK-A32 Shrink Fit Chuck _____ 68
 HSK-A40 Shrink Fit Chuck _____ 69
 HSK-A50 Shrink Fit Chuck _____ 70

HSK-A32/40/50 Power Collet Chuck _____ 71
 HSK-A32/40 ER Collet Chuck _____ 72
 HSK-A50 ER Collet Chuck _____ 73
 HSK-A40 Face Mill Arbor _____ 74
 HSK-A50 Face Mill Arbor _____ 75

HSK-A 63/DIN 69893-1

Shrink Fit Chuck _____ 76
 Power Shrink Chuck _____ 78
 Heavy Duty Chuck _____ 79
 Mini Shrink Chuck _____ 80
 Power Mini Shrink Chuck _____ 81
 Power Collet Chuck _____ 82
 ER Collet Chuck _____ 83
 HG Collet Chuck _____ 84
 Face Mill Arbor _____ 85
 Adapter for morse taper _____ 86
 Blank Adapter _____ 88

HSK-A 63/80 DIN 69893-1

Shrink Fit Chuck _____ 89
 Power Shrink Chuck _____ 90
 Power Mini Shrink Chuck _____ 94
 Power Collet Chuck _____ 95
 Face Mill Arbor _____ 96

HSK-A 80/DIN 69893-1

Shrink Fit Chuck _____ 97
 Power Shrink Chuck _____ 98
 ER Collet Chuck _____ 99
 Power Collet Chuck _____ 100

HSK-A 100/DIN 69893-1

Shrink Fit Chuck _____ 101
 Power Shrink Chuck _____ 102
 Heavy Duty Chuck _____ 103
 Power Collet Chuck _____ 104
 ER Collet Chuck _____ 105
 HG Collet Chuck _____ 106
 Face Mill Arbor _____ 107
 Adapter for morse taper _____ 108
 Blank Adapter _____ 110

HSK-A 125/DIN 69893-1

Power Shrink Chuck _____ 111
 Heavy Duty Chuck _____ 112
 Power Collet Chuck _____ 113
 Face Mill Arbor _____ 114

HSK-E 25/DIN 69893-5

Mini Shrink Fit Chuck _____ 115
 Collet Chuck Mini ER _____ 116
 Power Collet Chuck _____ 117

HSK-E 32/40/50 DIN 69893-5

HSK-E32 Shrink Fit Chuck _____ 118
 HSK-E40 Shrink Fit Chuck _____ 119
 HSK-E50 Shrink Fit Chuck _____ 120
 HSK-E32/40/50 Mini Shrink Chuck _____ 121
 Mini Shrink Shrink and Cooling Sleeves _____ 123
 HSK-E32/40/50 Power Collet Chuck _____ 124
 HSK-E32/40 ER Collet Chuck _____ 125

HSK-E50 ER Collet Chuck _____ 126
 HSK-E50 Face Mill Arbor _____ 127

HSK-F 63/DIN 69893-6

Shrink Fit Chuck _____ 128
 ER Collet Chuck _____ 129
 Face Mill Arbor _____ 130

HSK-F 80/Makino

Shrink Fit Chuck _____ 131
 ER Collet Chuck _____ 133
 Face Mill Arbor _____ 134

HAIMER CAPTO™ C6

ISO 26623

Shrink Fit Chuck _____ 136
 Power Shrink Chuck _____ 137
 ER Collet Chuck _____ 138
 Power Collet Chuck _____ 139
 Weldon Tool Holder _____ 140
 Face Mill Arbor _____ 141

Accessories

Shrink Fit Extension _____ 144
 Mini Shrink Extension _____ 145
 HG Mini Extension _____ 146
 Heavy Duty Shrink Extension _____ 147
 ER Collets _____ 148
 ER Collets sealed _____ 151
 Collets for Power Collet Chuck _____ 154
 Power Collets with Safe-Lock™ _____ 156
 Cool-Jet bores for Power Collet _____ 157
 Power Collet Torque Master _____ 158
 Power Collet inserts for Torque Master _____ 159
 HG Collets & HG Spindle wiper _____ 160
 Tool Clamp _____ 161
 Pull Studs _____ 162
 Reduction Sleeves _____ 165
 Balancing Index Rings _____ 166
 Coolant Tubes _____ 167
 Tension springs _____ 168
 Shrink Fit Brush _____ 169
 Backup screws _____ 170
 Spindle wiper _____ 172

Technical Data

Taper and Holder specifications _____ 173
 Overview of steep tapers _____ 174
 Overview of HSK tapers _____ 175
 Overview of CAPTO tapers _____ 177

Miscellaneous

Shrink Fit Chucks Comparison _____ 178
 Shrink Fit Chuck Advantages _____ 179
 Cool-Jet Cooling System _____ 180
 Cool Flash Cooling System _____ 182
 Safe-Lock™ features _____ 184
 Safe-Lock™ Application examples _____ 185

Please note: SK 30/40/50 are available as well.
 Please call our office for product offering and inventory situation.

THE SUITABLE CLAMPING TECHNIQUE FOR ALL TYPES OF MACHINING APPLICATIONS

Every industry has its specific requirements for tool holding. The range of applications varies from high speed cutting of aluminum to heavy machining of titanium.

For each industry with its typical machining applications HAIMER offers the right clamping technology. To find the suitable product for your specific application, please choose your industry.

Industry



Die and mold and medical engineering



Automotive engineering



General mechanical engineering



Aerospace industry



Heavy machinery industry

Requirements to tool holding

Suitable tool holder

- High Speed Cutting HSC
- Slim tooling
- Long protruding lengths for deep cavities
- Mostly low cutting forces at high rpm
- Vibration dampening features
- 5-axis-machining
- High flexibility in tool clamping
- Modular system with shrink fit extensions

- Mini Shrink
- Power Mini Shrink Chuck
- Shrink Fit Chuck standard and extensions
- Power Collet Chuck
- High-Precision Chuck
- ER Collet Chuck

- Process reliability in the series production
- Machining of deep bores
- Pull out protection for cutting tools with Safe-Lock™
- Consistent high quality in the procurement of spare parts

- Shrink Fit Chuck standard and extensions
- Power Shrink Chuck
- ER Collet Chuck

- High flexibility of tool clamping
- Tool holders for universal usage
- Vibration-free machining
- Modular system with shrink fit extensions

- Shrink Fit Chuck standard and extensions
- Power Shrink Chuck
- ER Collet Chuck
- High-Precision Chuck and extensions
- Power Collet Chuck

- Low vibrations at high speed for aluminum cutting
- High cutting capacity (High Performance Cutting, HPC)
- Extreme rigidity and clamping force for titanium machining
- Pull out protection for cutting tools with Safe-Lock™

- Shrink Fit Chuck standard and extensions
- Power Shrink Chuck
- Heavy Duty Chuck and extensions
- Power Collet Chuck
- High-Precision Chuck and extensions
- ER Collet Chuck

- Machining of large steel and cast parts, e.g. gear housings
- High cutting forces at low to medium rpm
- High rigidity, even at long protruding lengths

- Shrink Fit Chuck standard
- Power Shrink Chuck
- Heavy Duty Chuck and extensions
- ER Collet Chuck
- Power Collet Chuck

ARE YOU READY FOR THE NEXT GENERATION OF MACHINING EFFICIENCY?

All shrink fit holders are not created equal. Choose Haimer holders for best results.

Total quality control

- All made at HAIMER in Germany
- Consistent material
- High-temperature resistant special steel
- High clamping force
- Long clamping bore
- Best runout accuracy
- TIR within 0.00012" at 3 times diameter
- Patented back-up screw
- Prebalanced to G2.5@25,000 RPM
- Fine balancing with set-screws possible
- "Cool-Jet" coolant delivery available
- Bore for the data chip standard
- "DIN-B" standard
- AT3 taper or better on steep taper
- HSK specialists
- Many tapers available

Shrinking holders from HAIMER

- Power Shrink
- Mini Shrink
- Safe-Lock™
- Extensions

Tapers

- CAT40/CAT50
- BT30/BT40/BT50
- SK30/SK40/SK50
- HSK25E
- HSK32A/E
- HSK40A/E
- HSK50A/E
- HSK63A/E/F
- HSK80A
- HSK100A
- HSK125A
- HSK80F Makino
- Capto C6

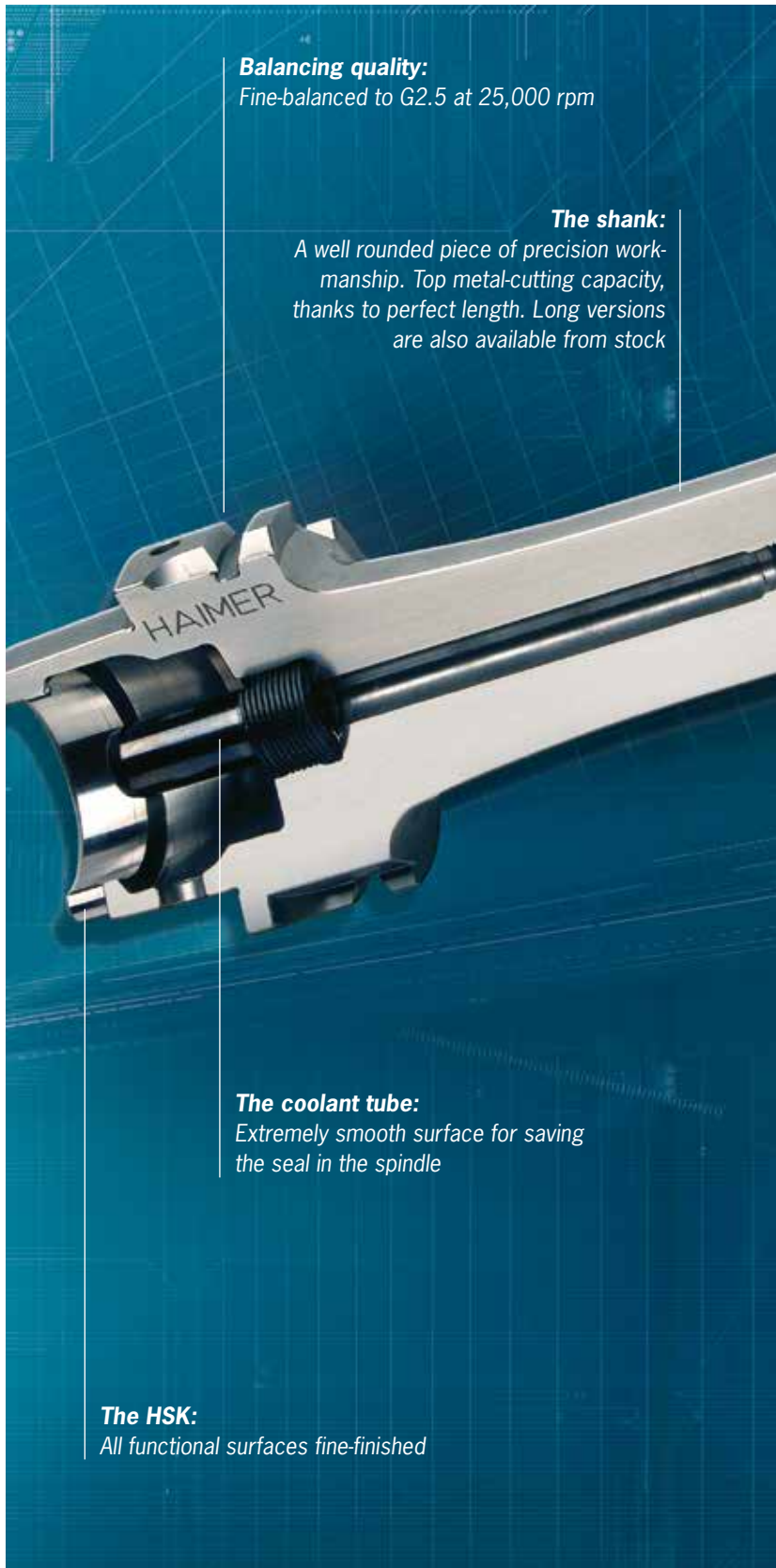

Balancing quality:

Fine-balanced to G2.5 at 25,000 rpm

The shank:

A well rounded piece of precision workmanship. Top metal-cutting capacity, thanks to perfect length. Long versions are also available from stock

The coolant tube:

Extremely smooth surface for saving the seal in the spindle

The HSK:

All functional surfaces fine-finished

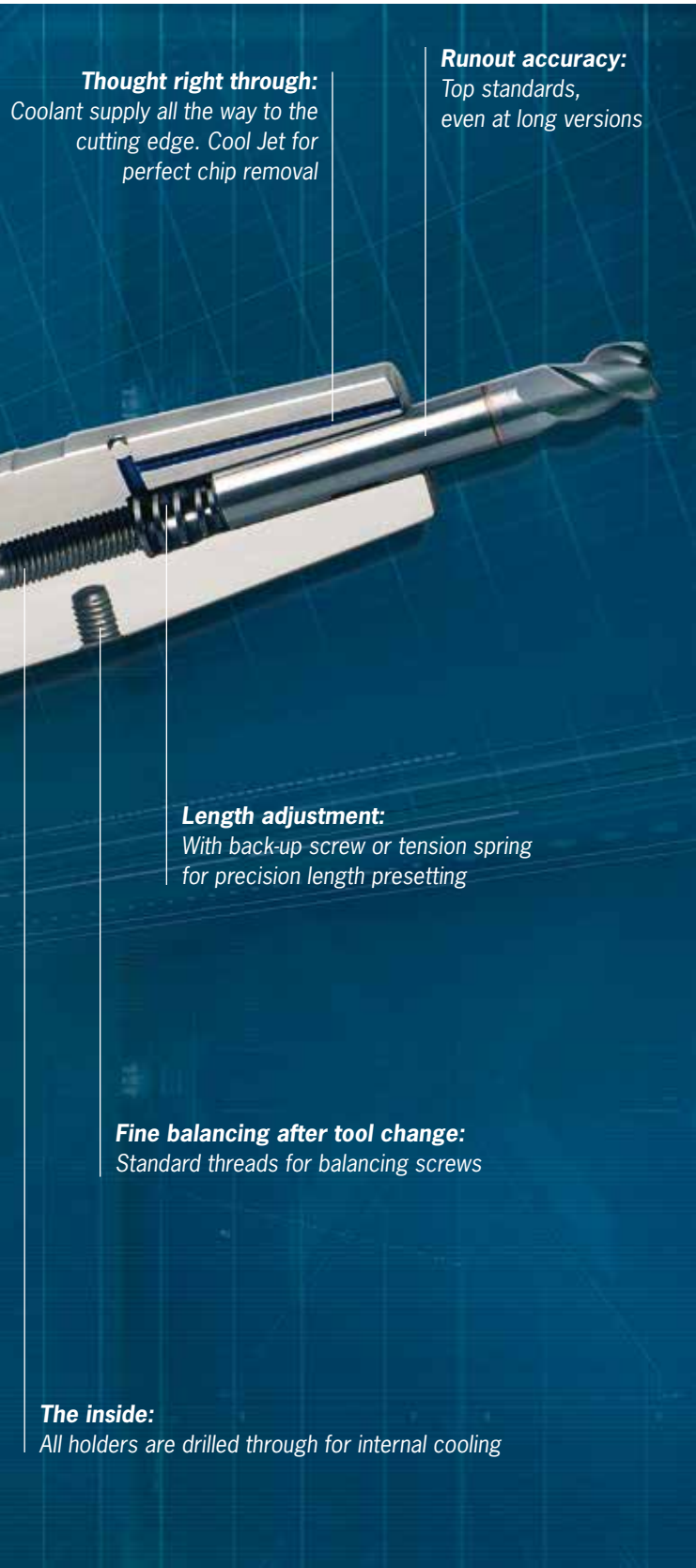

Are you saving costs at the right place?

For machining efficiently all possibilities for saving must be explored . But where are these potential savings?

Roughly, the costs of a work piece are composed as following:

Machine costs with operator (machining time and idle time)	approx. 50 %
General costs	approx. 30 %
Raw material	approx. 15 %
Tooling	approx. 4 %
Tool holder	approx. 1 %

Assume you could save 50% on tool holders, tooling and machining time.

The resulting potential savings are as follows:

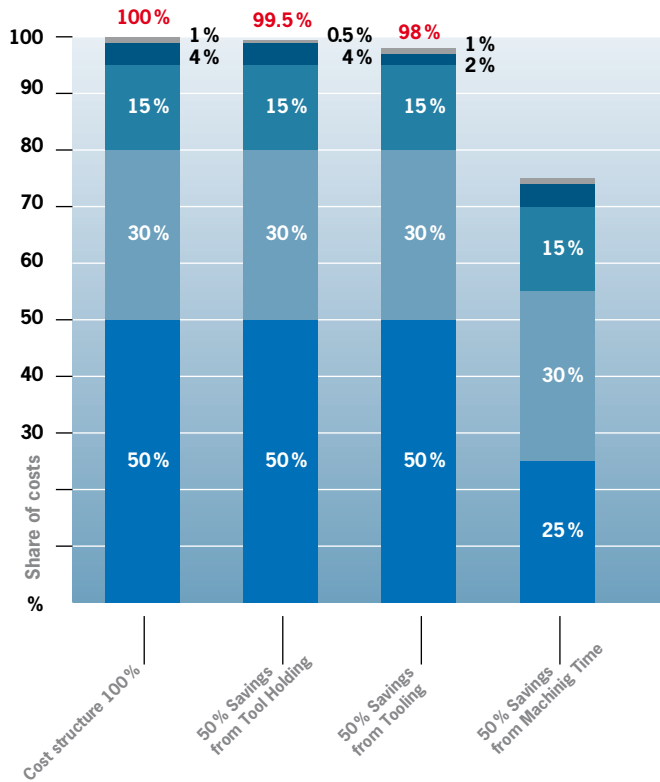

The result: The costs for tooling and tool holders are nearly meaningless. Even with savings of 50% the total costs remain nearly the same.

Essential savings can be reached by minimizing the machining time. This potential only can be exploited when the cutting process is optimized.

Tool holders from HAIMER for more efficiency at high speed machining:

- Higher cutting capacity
- Extended tool life
- Shorter machining times
- High runout accuracy
- Better surface finish
- High reliability of the whole process

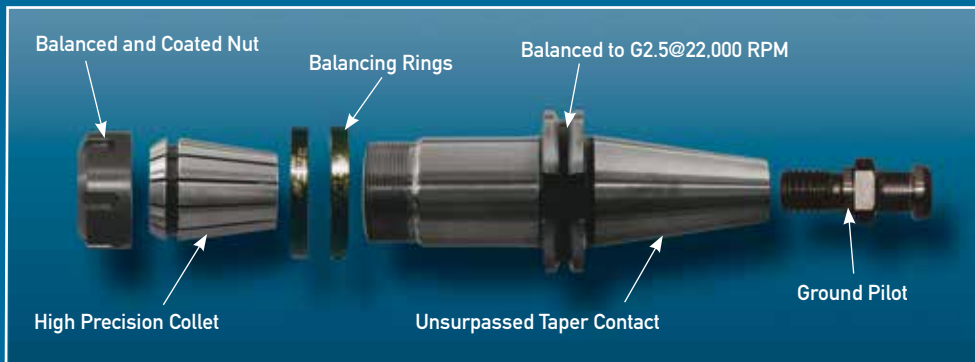

Highest Quality.....Best Value
Full Quality Control – All made in house at the HAIMER factory

ER COLLET CHUCKS

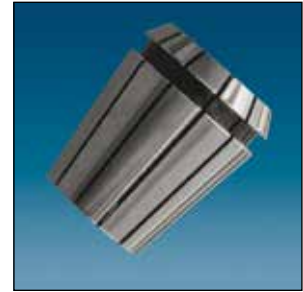
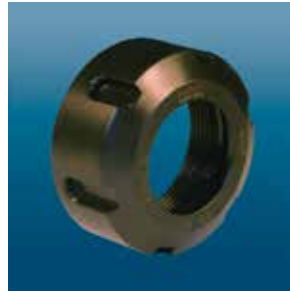

Balanced & coated nut included with all ER collet chucks.

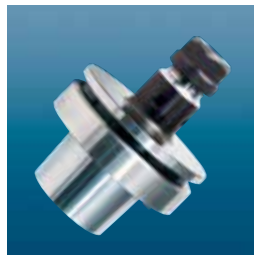

FEATURES

- Runout less than 0.00012" in the collet bore
- High precision collets are the HAIMER standard
- Holders balanced to G2.5 at 22,000 RPM
- Precision ground OD threads
- Special coating on the clamping nut: Provides maximum tightening of the tool and minimal collet distortion, which leads to less runout and greater collet life.
- Clamping nuts are balanced by design, due to varied slot depths and fixed location of the inner ring. Fine balanced clamping nuts are also available.
- Various gage lengths available for CAT, BT, HSK, HAIMER Capto™ and SK tapers
- "DIN B" coolant through the flange comes standard on all CAT, BT, HAIMER Capto, HSK and SK tapers



For more efficient
high speed machining.



POWER SERIES – ONLY GENUINE WITH THE HAIMER SINUS CURVE

Where normal cutting ends, the Power Series begins.

Vibrations? Difficult materials? High cutting strength? Pressure to reduce cost? The Power Series is intended for all of these cases. Power Shrink Chucks and Power Collet Chucks from HAIMER are the solution to the problem. Their design allows the Power Series Chuck to function without vibration. If a machine with conventional chucks begins to chatter, Power Chucks let you step up to another gear.

Need a little more feed rate, a little more cutting depth and a little more cutting width? This is how money is earned when machining.

Expensive special tools? High-capacity spindle? All is well and good? But are you utilizing the maximum potential of the machine tool? The tool and collet chuck must form one unit. Only together can they bring the optimal cutting performance of the spindle to the work-piece as well.

Use your potential.

The new HAIMER Power Series For highest cutting capacity

- High level of rigidity
- Low tendency to vibrate
- High level of concentricity
- For extreme cutting performance
- For universal use

Vibration measurement in test cuts

Comparison between Power Shrink Chucks and hydraulic chucks

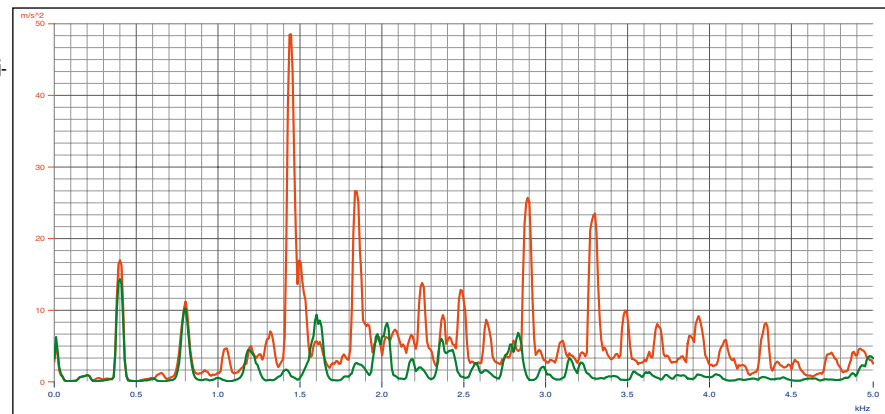

Vibration measurement

■ HAIMER Power Shrink Chuck A = 65 ■ Hydraulic chuck A = 80

Source: HAIMER, machining center: DMG 4-axis SK40 type DMC 60H



Milling image of Power Shrink Chuck



Milling image of hydraulic chuck



The evolution



Standard Shrink Fit Chuck

Always one step ahead with innovations.

HAIMER, the technology leader for tool holders, annually invests about ten percent of its turnover into research and development. The primary interest of HAIMER in developing new products is to offer solutions to our customers as a system provider.

With the trend towards faster machine tools with higher RPM and the challenge to reach high efficiency and maximized cutting volume, our customers' requirements are changing. Starting with the **Standard Shrink Fit Chuck** which is suitable for a broad range of applications, the close cooperation with customers of the aerospace industry has led to the development of

the **Power Shrink Chuck**. Thus a much higher chip removal rate and a considerably higher tool life e.g. in the cutting of aluminium could be achieved. At the same time the Safe-Lock™ system was developed for extremely critical applications to prevent the slow pull out of cutting tools.

The last advancement in the evolution of HAIMER shrink fit chucks, which you can see in detail on the inside pages of this cover, is the **Heavy Duty Chuck**. The extremely rigid outer geometry and the reinforced wall thickness at the clamping bore make it a profitable chuck for highest performances e.g. for the cutting of titanium in the aerospace industry or in the heavy machinery industry.

of shrink fit technology



Power Shrink Fit Chuck



Heavy Duty Shrink Fit Chuck

Three series – one million applications.



Die and mold and
medical engineering



Automotive
engineering



General mechanical
engineering



Aerospace industry



Heavy machinery
industry



Always one step ahead with innovations.

Similarly to the Shrink Fit Chucks, HAIMER has also developed the existing technology of Collet Chucks even further.

The universally applied standard **ER Collet Chucks**, which you still can find on almost every milling machine today, were optimized by HAIMER in regards to design, precision and safety.

The **Power Collet Chucks** are Collet Chucks designed for high speed cutting (HSC) – an alternative to the reinforced shrink fit chucks of the power series. Their usage is versatile – for almost any finishing, roughing and drilling application. Power Collet Chucks offer a reinforced wall thickness and extra rigid outer contour, making them stable and resistant to vibrations. The inner contour is designed so that all standard ER collets can be used. However, the chucks only achieve maximum performance when using the specifically developed HAIMER high-precision collets, resulting in $<0.00012''$ ($3\mu\text{m}$) runout and a higher

cutting capacity.

The Power Collet Chuck can be optionally equipped with Safe-Lock™ and therefore offers maximum tool pullout protection.

With the **Heavy Duty Collet Chuck**, which was specifically developed for heavy duty roughing in the heavy machining industry as well as in the aerospace industry, a new standard has been set. It has a very high runout accuracy of $<0.00012''$ ($3\mu\text{m}$), enormous clamping forces and thanks to its robust geometry, an extremely low tendency to vibrate.

All Heavy Duty Collet Chucks can be equipped with Safe-Lock™, the pull-out protection developed by HAIMER.

The development of Safe-Lock™ for Collet Chucks now provides customers, who don't use the shrink fit technology so far, with a high precision mechanical clamping system that includes the process reliability guaranteed by Safe-Lock™. A unique advantage!

The evolution



Standard ER Collet Chuck

of ER Collet Chuck technology



Power Collet Chuck



Heavy Duty Collet Chuck

Three series – one million applications.



Die and mold and
medical engineering



Automotive
engineering



General mechanical
engineering



Aerospace industry



Heavy machinery
industry

POWER COLLET CHUCK
HIGH PRECISION COLLET CHUCK

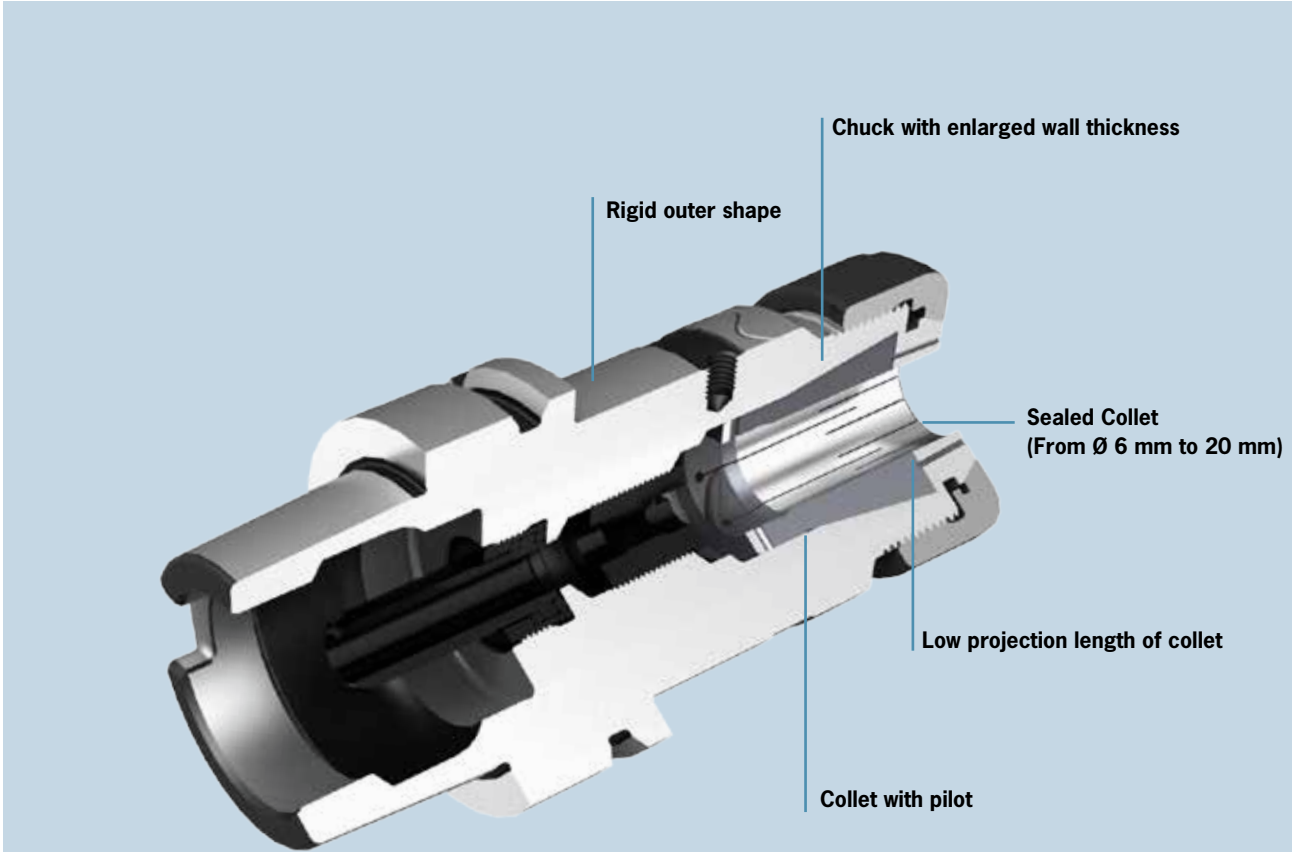

Power Collet Chuck long



Power Collet Chuck short

Power Collet Chuck - High Precision Collet Chuck

- Highest concentricity: 0.003 mm at 3 x D (with Power Collets)
- Reduced vibration due to optimized geometry
- All standard ER-Collets can be used
- Highest rigidity
- Universal use, even for maximum power cutting process

POWER COLLET CHUCK HIGH PRECISION COLLET CHUCK

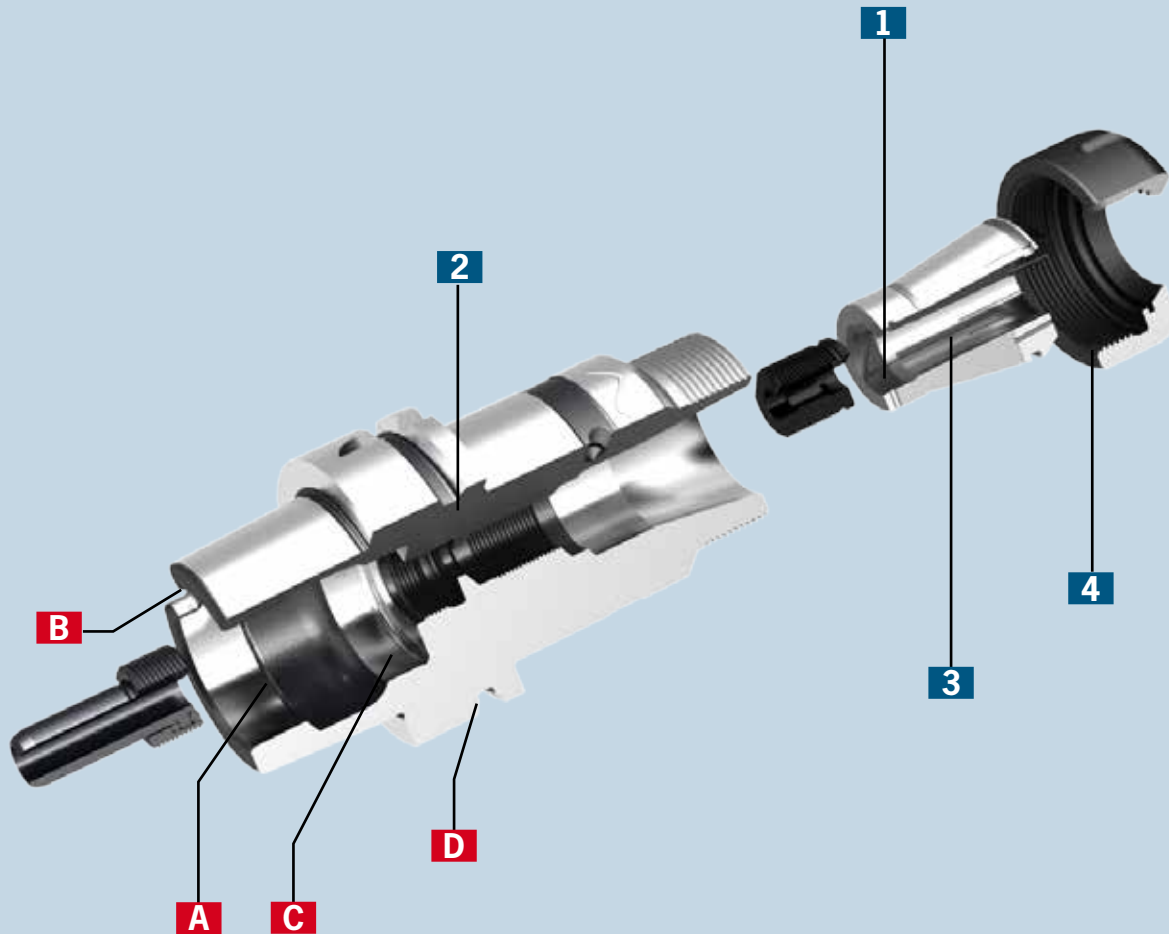

- 1** – Safe-Lock™ in the high precision collet (optional)
- 2** – Low tendency towards vibrations due to reinforced wall thickness
- 3** – High-precision Power Collet (0.003 mm at the tool) with pilot for highest concentricity and max. process reliability
- 4** – Fine balanced Power Collet nut

Characteristics HSK:

- A** Clamping shoulder finished for equal force allocation during the clamping process and for optimized runout accuracy
- B** Drive slots finished machined after heat treat
- C** Ground surface finished for reliable ejection of the tool
- D** Fine balanced for high RPM

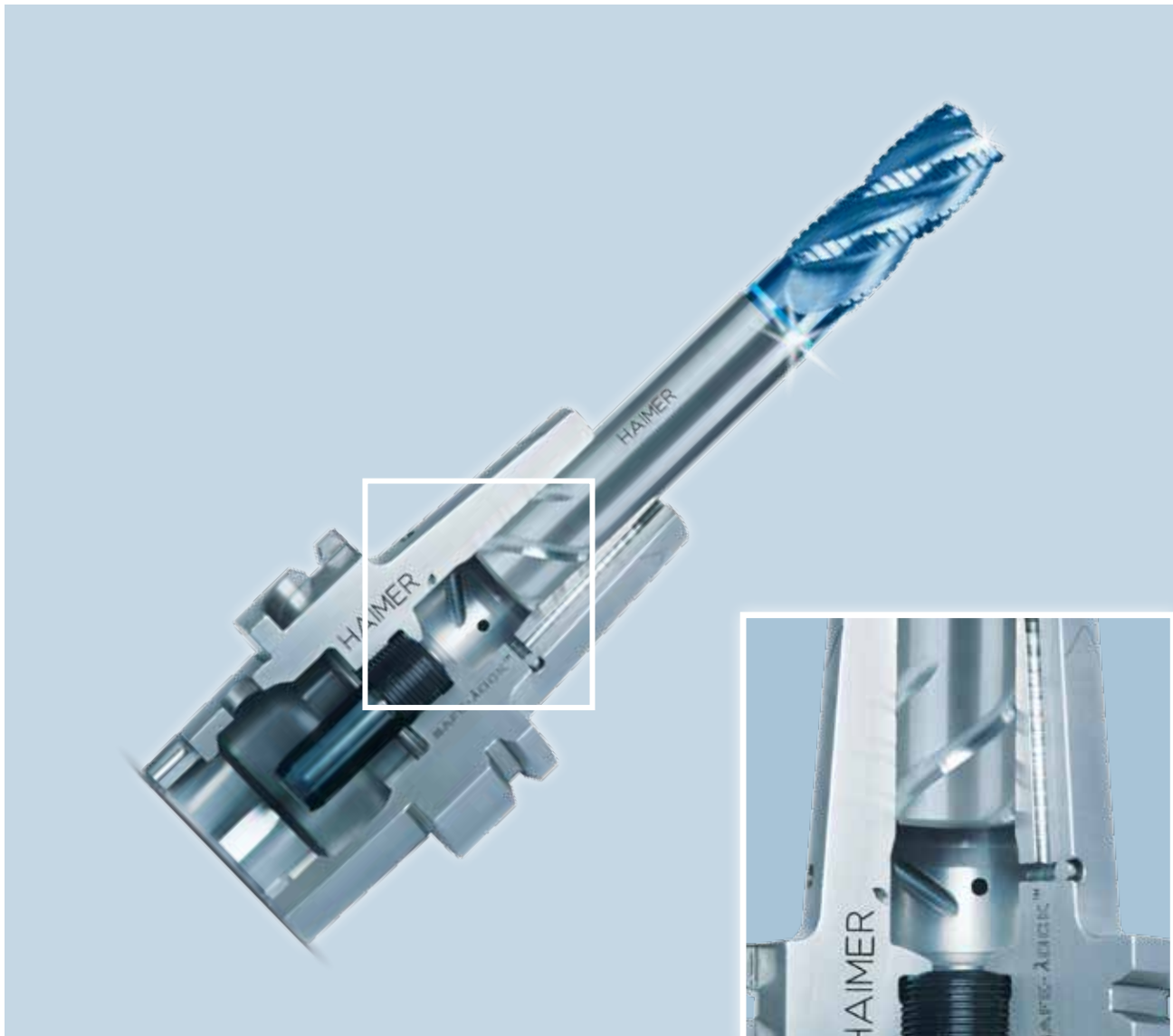

SAFE-LOCK® – The safety belt for your tools

In high performance cutting (HPC), it is possible for the cutting tool to be pulled out of the chuck. The reason is a slow micro-creeping motion. It happens when cutting at high speeds and with high pull out forces. Even chucks with extremely high clamping force cannot prevent micro-creeping. High-quality work pieces become scrap as a result. **The Safe-Lock™ system offers a solution.**

Drive keys in the chuck / collet grip in grooves in the tool shank. In addition to the frictional clamping forces of the tool holder, the tool is held using positive locking. As a result, micro-creeping is effectively prevented and your tool is clamped safely.

Your advantages – Be on the safe side with SAFE-LOCK®

- For High Performance Cutting (HPC)
- Highly accurate clamping due to shrink fit or collet chuck technology, runout accuracy < 0.00012" (3 µm)
- High torque due to form closed clamping
- No pull out of the tool, thus no damages to the work piece or machine
- No spinning of the tool
- The groove on the tool shank is directed so that the tool will be pulled into the chuck (depending on direction of rotation)
- Patent granted: licensing possible



**Maximum metal removal rate
with absolute process reliability**

SAFE-LOCK® PULL OUT PROTECTION – FUNCTIONALITY

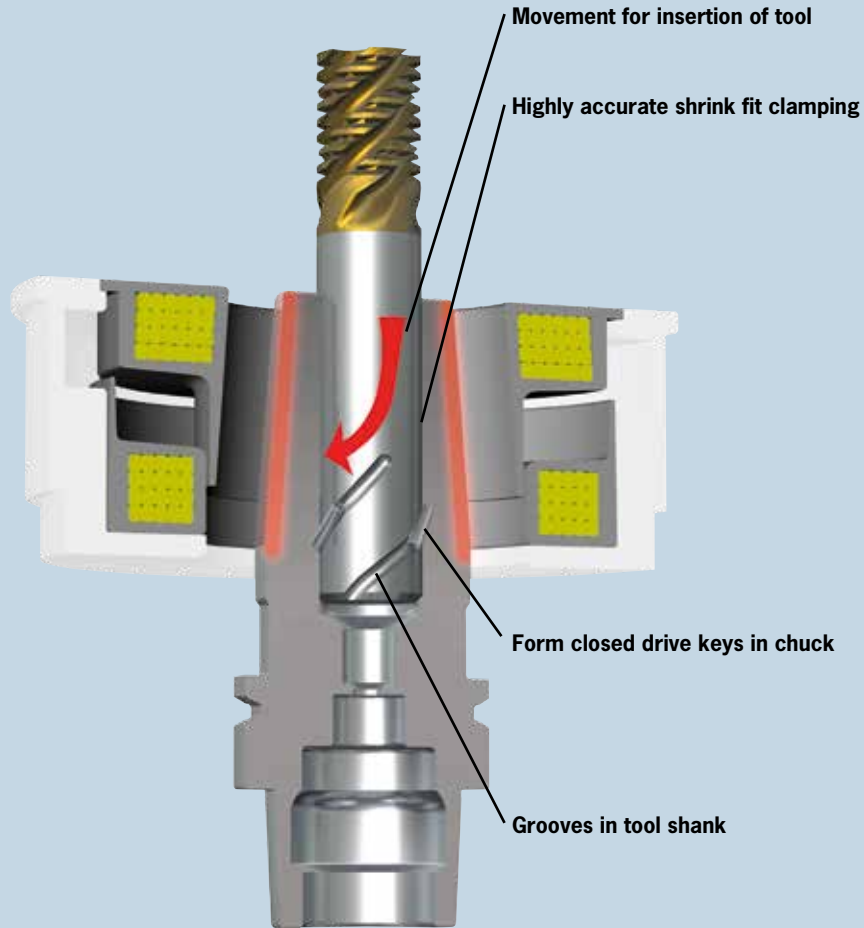

Power Shrink Chuck with SAFE-LOCK®

Power Collet Chuck with SAFE-LOCK®

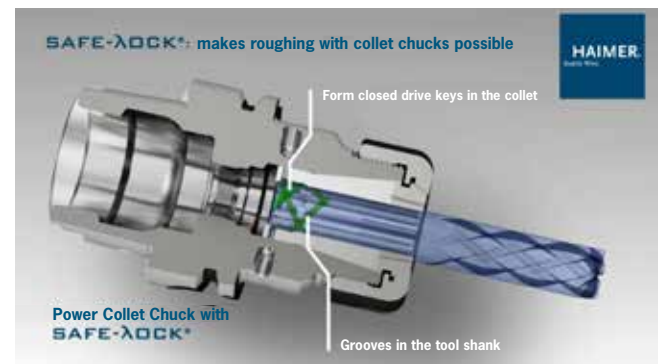



Cool-Jet: For cool cutting edges

Cool-Jet – cut the chips only once!

- Coolant directly to the cutting edge
- Extended tool life up to 100%
- Higher reliability of cutting process
- Eliminates chip packing and chip welding

Function at high spindle speed

Previous coolant bores: straight
Optimized coolant bores: aimed at the center

COOL FLASH

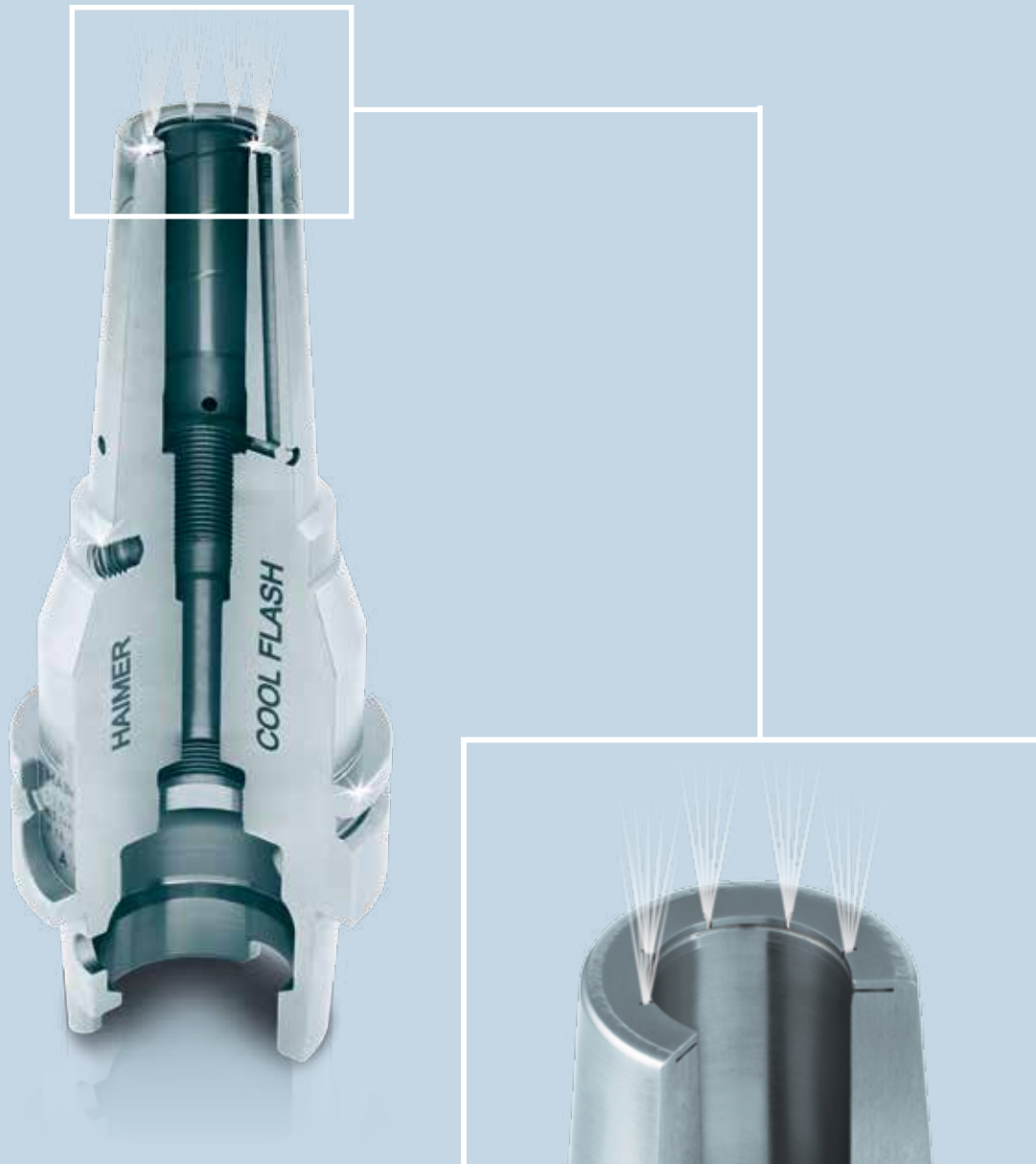

Cool Flash:
Optimized cooling to the cutting edge

Cooling slots feed the coolant down to the cutting edge of the tool.

- Handling _____ simple and safe
- Beneficial Application _____ without interference contour
- Cooling range at the cutting edge _____ 100 %
- Tool life _____ maximized
- Chip removal _____ optimized
- RPM _____ for High Speed Cutting (HSC)
- Application range _____ for all areas of application
- Diameter range _____ from ¼"-1"
- More _____ **Pages 182/183**



Heavy Duty Shrink Chuck: Shrink fit chuck for extreme cases

Finally there is a holder for heavy machining that can replace the Weldon tool holder. The Heavy Duty Chuck is a shrink fit chuck designed for extreme cases. The contour is optimized for highest rigidity and clamping force.

Available for the following interfaces:

- CAT 50
- SK50
- BT50
- HSK-A63/100/125

ACCESSORIES



HG Mini Extensions:
For micro applications

HAIMER HG Mini extensions are based on the approved HG clamping technology – only far more delicate. With HG Mini extensions you can cover the micro-clamping range from 1 mm to 4.5 mm. They are perfect for light milling and drilling operations. You won't find a smaller and more delicate tool than this!



Torque Master:
For ER Collets and Pull Studs

- For highest runout accuracy, no one-sided clamping
- Optimal power transmission by Consistent force application
- Torque wrench for highest clamping and repeatability with dial gauge
- Maximum torque for highest clamping force
- No overloading of smaller clamping diameters
- Changeable inserts, useable also for standard ER-Collets

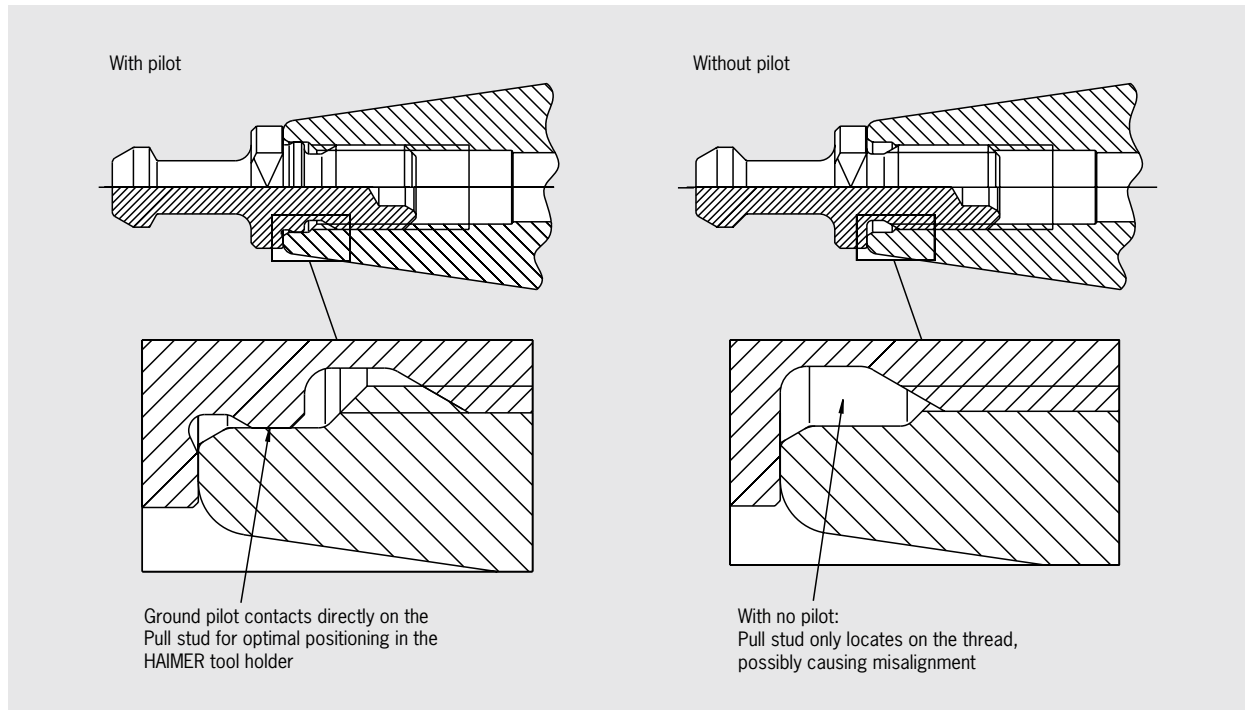

HAIMER goes far beyond the requirements of CAT 40 tooling. Our experience with tool holders and balancing have merged together to successfully create far superior CAT tapered tooling.

In addition to our unsurpassed taper contact and 100% inspection process of our tapers, HAIMER has developed a special feature to greatly increase your tool holder balance repeatability and your machine tool spindle draw mechanism repeatability.

We have added a ground pilot in the rear of all our CAT 40 tool holders. This ground pilot fits perfectly with the special HAIMER pull stud to maximize your tool holder to machine tool connection. The ground pilot is larger than the standard ANSI dimension, so you can easily use any pull stud from any manufacturer. However, for those serious about balance and machine tool spindle draw repeatability, HAIMER has the answer for you with our special pull-stud/pilot connection!

CAT 40

CAT 50

CAT 40/ASME B5.50

Shrink Fit Chuck	26
Power Shrink Chuck	27
Power Mini Shrink Chuck	28
Power Collet Chuck	29
ER Collet Chuck	30
Face Mill Arbor	31

CAT 50/ASME B5.50

Shrink Fit Chuck	33
Power Shrink Chuck	34
Heavy Duty Chuck	35
Power Collet Chuck	36
ER Collet Chuck	37
Face Mill Arbor	38

SHRINK FIT CHUCK
CAT 40 · ASME B5.50

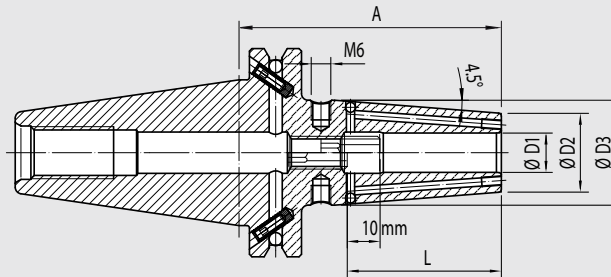

CERTIFICATE OF QUALITY

- Chuck body fine balanced
G2.5 25,000 rpm
or U<1 gmm
- All functional surfaces machined
- Taper tolerance AT3
- Coolant supply form ADB

Use:

Shrink fit chuck suitable for use with all available shrink fit units.

CAT 40 FORM ADB

Form ADB means: central-coolant supply and coolant channels through the flange which can be sealed again

- Heat resistant hot-working steel
- Hardened 54-2 HRC
- For HSS and solid carbide tools
- Shank tolerance h6
- With threaded holes for balancing screws
- Cool-Jet coolant bores that can be sealed included

Optional:

- Cooling with Cool Flash from ¼"-1" for an extra charge (See pp. 182/183)
- Safe-Lock™ Pull out protection (See pages 184-187)

Standard version, similar to DIN 69882-8

INCH	Clamping Ø D1 [inch]		1/8"	3/16"	1/4"	5/16"	3/8"	7/16"	1/2"	5/8"	3/4"	7/8"	1"	1 1/4"
	Ø D2 [inch]		0.39	0.39	0.83	0.83	0.94	0.94	1.06	1.30	1.30	1.73	1.73	
	Ø D3 [inch]				1.06	1.06	1.26	1.26	1.34	1.65	1.65	2.09	2.09	
	L [inch]		0.35	0.47	1.42	1.42	1.65	1.65	1.85	1.97	2.05	2.28	2.28	
Gage length A [inch]	short		3.15 ¹⁾	3.15 ¹⁾	3.15	3.15	3.15	3.15	3.15	3.15	3.15	3.15	3.94	3.94
Standard Order No.	40.840...		.1/8Z	.3/16Z	.1/4Z.4	.5/16Z.4	.3/8Z.4	.7/16Z.4	.1/2Z.4	.5/8Z.4	.3/4Z.4	.7/8Z.4	.1Z.4	.1 1/4Z.4
Gage length A [inch]	ZG130		-	-	5.12	5.12	5.12	5.12	5.12	5.12	5.12	5.12	5.12	5.12
Order No.	40.844...				.1/4Z.4	.5/16Z.4	.3/8Z.4	.7/16Z.4	.1/2Z.4	.5/8Z.4	.3/4Z.4	.7/8Z.4	.1Z.4	.1 1/4Z.4
Gage length A [inch]	oversize		-	-	6.30	6.30	6.30	6.30	6.30	6.30	6.30	6.30	6.30	6.30
Order No.	40.842...				.1/4Z.4	.5/16Z.4	.3/8Z.4	.7/16Z.4	.1/2Z.4	.5/8Z.4	.3/4Z.4	.7/8Z.4	.1Z.4	.1 1/4Z.4

METRIC	Clamping Ø D1 [mm]		03	04	05	06	08	10	12	14	16	20	25	32
	Ø D2 [mm]		10	10	10	21	21	24	24	27	27	33	44	44
	Ø D3 [mm]					27	27	32	32	34	34	42	53	53
	L [mm]		09	12	15	36	36	42	47	47	50	52	58	58
Gage length A [mm]	short		80 ¹⁾	80 ¹⁾	80 ¹⁾	80	80	80	80	80	80	80	100	100
Order No.	40.840...		.03	.04	.05	.06.4	.08.4	.10.4	.12.4	.14.4	.16.4	.20.4	.25.4	.32.4
Gage length A [mm]	ZG130		-	-	-	130	130	130	130	130	130	130	130	130
Order No.	40.844...					.06.4	.08.4	.10.4	.12.4	.14.4	.16.4	.20.4	.25.4	.32.4
Gage length A [mm]	oversize		-	-	-	160	160	160	160	160	160	160	160	-
Order No.	40.842...					.06.4	.08.4	.10.4	.12.4	.14.4	.16.4	.20.4	.25.4	

Standard version with Safe-Lock™ and M3 seal screw installed

INCH	Clamping Ø D1 [inch]		1/4"	5/16"	3/8"	1/2"	5/8"	3/4"	1"	1 1/4"
	Ø D2 [inch]		0.83	0.83	0.94	0.94	1.06	1.30	1.73	1.73
	Ø D3 [inch]		1.06	1.06	1.26	1.26	1.34	1.65	2.09	2.09
	L [inch]		1.42	1.42	1.65	1.85	1.97	2.05	2.28	2.28
Gage length A [inch]	short		3.15	3.15	3.15	3.15	3.15	3.15	3.94	3.94
Order No.	40.840...		.1/4Z.47	.5/16Z.47	.3/8Z.47	.1/2Z.47	.5/8Z.47	.3/4Z.47	.1Z.47	.1 1/4Z.47

METRIC	Clamping Ø D1 [mm]		06	08	10	12	14	16	20	25	32
	Ø D2 [mm]		21	21	24	24	27	27	33	44	44
	Ø D3 [mm]		27	27	32	32	34	34	42	53	53
	L [mm]		36	36	42	47	47	50	52	58	58
Gage length A [mm]	short		80	80	80	80	80	80	80	100	100
Order No.	40.840...		.06.47	.08.47	.10.47	.12.47	.14.47	.16.47	.20.47	.25.47	.32.47

1) Without back-up screw, without threads for balancing screws, with slits along the clamping bore for coolant around the tool

POWER SHRINK CHUCK CAT 40 · ASME B5.50



CERTIFICATE OF QUALITY

- Chuck body fine balanced
G2.5 25,000 rpm
or U<1 gmm
- All functional surfaces machined
- Taper tolerance AT3
- Coolant supply form ADB
- Cool-Jet, can be sealed

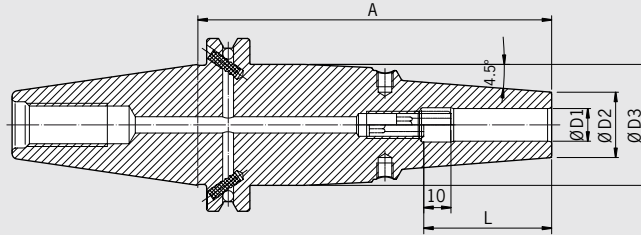

The Power Shrink Chuck is designed for the highest cutting performance in high-speed manufacturing. The optimized design combines high rigidity with vibration dampening, which protects the machine, spindle and tool.

- Highest cutting performance with higher spindle speeds, higher feeds and larger cutting depths
- Shorter cycle times, higher machining accuracy
- Quieter running, therefore better surface quality and protection of tools, spindles and machines
- With threaded holes for balancing screws
- Cool-Jet coolant bores that can be sealed included

The long versions with slim tips are especially versatile to use.

- High rigidity, slim at the tip, dampen vibrations
- Higher clamping forces
- Equally suited to high-speed manufacturing and heavy milling
- Universal usage, saves space in tool magazine

Optional:

- Cooling with Cool Flash for an extra charge (See pp. 182/183)
- Safe-Lock™ Pull out protection (See pages 184–187)

INCH	Ø D1 [inch]	1/4"	5/16"	3/8"	1/2"	5/8"	3/4"	1"
	Ø D2 [inch] ultra short	0.87	0.87	1.04	1.04	1.16	1.40	1.79
	Ø D3 [inch] ultrashort	1.75	1.75	1.75	1.75	1.75	1.75	1.75
	L [inch] ultra short	1.42	1.42	1.65	1.85	1.97	2.05	2.28
Gage length A [inch]	ultra short	2.56	2.56	2.56	2.56	2.56	2.56	2.95
Standard Order No.	40.845...	.1/4z.3	.5/16z.3	.3/8z.3	.1/2z.3	.5/8z.3	.3/4z.3	.1z.3
Safe-Lock™ Order No.	40.845...	.1/4z.37	.5/16z.37	.3/8z.37	.1/2z.37	.5/8z.37	.3/4z.37	.1z.37
	Ø D2 [inch] ZG130/oversize	0.83	0.83	0.94	0.94	1.06	1.30	—
	Ø D3 [inch] ZG130/oversize	1.75	1.75	1.75	1.75	1.75	1.75	—
	L [inch] ZG130/oversize	1.42	1.42	1.65	1.85	1.97	2.05	—
Gage length A [inch]	ZG130	5.12	5.12	5.12	5.12	5.12	5.12	—
Standard Order No.	40.844...	.1/4z.3	.5/16z.3	.3/8z.3	.1/2z.3	.5/8z.3	.3/4z.3	—
Safe-Lock™ Order No.	40.844...	.1/4z.37	.5/16z.37	.3/8z.37	.1/2z.37	.5/8z.37	.3/4z.37	—
Gage length A [inch]	oversize	6.30	6.30	6.30	6.30	6.30	6.30	—
Standard Order No.	40.842...	.1/4z.3	.5/16z.3	.3/8z.3	.1/2z.3	.5/8z.3	.3/4z.3	—
Safe-Lock™ Order No.	40.842...	.1/4z.37	.5/16z.37	.3/8z.37	.1/2z.37	.5/8z.37	.3/4z.37	—

METRIC	Ø D1 [mm]	6	8	10	12	16	20	25
	Ø D2 [mm] ultra short	22	22	26.5	26.5	29.5	35.5	45.5
	L [mm] ultra short	36	36	42	47	50	52	58
Gage length A [mm]	ultra short	65	65	65	65	65	65	75
Standard Order No.	40.845...	.06.3	.08.3	.10.3	.12.3	.16.3	.20.3	.25.3
Safe-Lock™ Order No.	40.845...	.06.37	.08.37	.10.37	.12.37	.16.37	.20.37	.25.37
	Ø D2 [mm] ZG130/oversize	21	21	24	24	27	33	—
	Ø D3 [mm] ZG130/oversize	44.45	44.45	44.45	44.45	44.45	44.45	—
	L [mm] ZG130/oversize	36	36	42	47	50	52	—
Gage length A [mm]	ZG130	130	130	130	130	130	130	—
Standard Order No.	40.844...	.06.3	.08.3	.10.3	.12.3	.16.3	.20.3	—
Safe-Lock™ Order No.	40.844...	.06.37	.08.37	.10.37	.12.37	.16.37	.20.37	—
Gage length A [mm]	oversize	160	160	160	160	160	160	—
Order No.	40.842...	.06.3	.08.3	.10.3	.12.3	.16.3	.20.3	—
Safe-Lock™ Order No.	40.842...	.06.37	.08.37	.10.37	.12.37	.16.37	.20.37	—

POWER MINI SHRINK CHUCK
CAT 40 · ASME B5.50

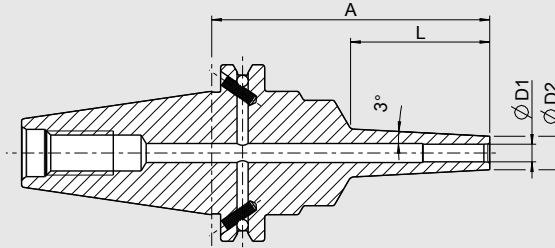

CERTIFICATE OF QUALITY

- ✓ Chuck body fine balanced
G2.5 25,000 rpm
or U<1gmm
- ✓ All functional surfaces machined
- ✓ Taper tolerance AT3
- ✓ Coolant supply form ADB

Power Mini Shrink Chuck is perfect for 5-axis-machining in the die & mold and medical industry. Very slim at the top like the HAIMER Mini Shrink Chucks, but the Power Mini Shrink is reinforced at the base. Therefore, efficient milling is possible with an angled tool even at long protruding lengths.

- Extreme slim design
- No disturbing edges
- TIR less than 0.00012" (3µm)
- Ideal for the HAIMER Power Clamp
- For all solid carbide tools with shank tolerance h6
- With 3° slope for dies and molds
- **Attention: Heating and cooling only with shrink and cooling sleeves (see accessories)**

INCH	Clamping Ø D1 [inch]	1/8"	3/16"	1/4"	3/8"	1/2"
	Ø D2 [inch]	0.35	0.43	0.47	0.63	0.81
	L [inch]	1.97	1.97	1.97	1.97	1.42
	Gage length A [inch]	3.94	3.94	3.94	3.94	3.15
	Order No.	40.889...	.1/8z.0002	.3/16z.0002	.1/4z.0001	.3/8z.0001
	Suitable Shrink and cooling sleeves					
	Order No.	80.105.14...	.2.04	.2.05	.2.09	.2.11

METRIC	Clamping Ø D1 [mm]	04	06
	Ø D2 [mm]	12	10
	L [mm]	50	50
	Gage length A [inch]	100	100
	Order No.	40.889...	.04.8.1001
	Suitable Shrink and cooling sleeves		
	Order No.	80.105.14...	.2.08

1) With EDM slits

Shrink and cooling sleeve

- Protects Mini Shrink chucks from overheating
- Extends lifetime of shrink fit chucks
- Secure and user friendly handling
- Only one parameter setting needed for all Mini Shrink chucks
- Cooling with standard cooling body

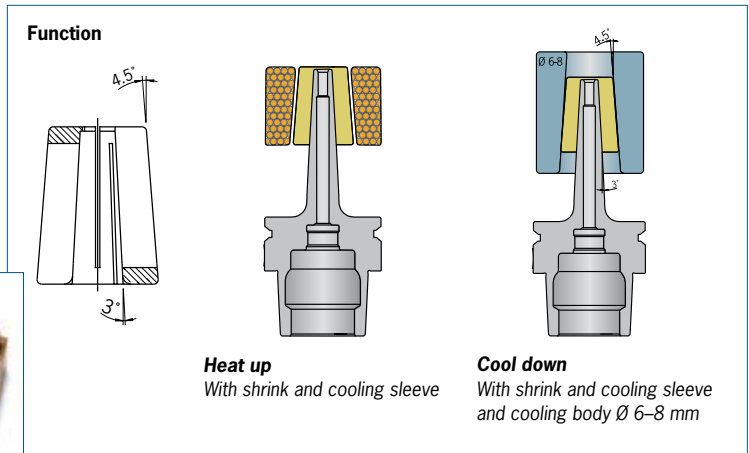

POWER COLLET CHUCK
CAT 40 · ASME B5.50



CERTIFICATE OF QUALITY	
<input checked="" type="checkbox"/>	Chuck body fine balanced G2.5 25,000 rpm
<input checked="" type="checkbox"/>	All functional surfaces fine-machined
<input checked="" type="checkbox"/>	Taper tolerance AT3
<input checked="" type="checkbox"/>	Coolant supply form ADB

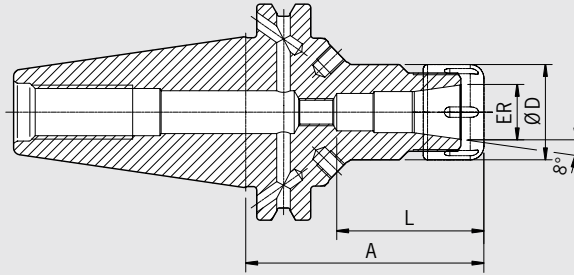

The Power Collet Chuck is designed for the highest machining capacity in high-speed manufacturing. The optimized design with improved construction combines high rigidity with vibration dampening features, giving more protection to the machine, spindle and tool. The universal Power Collet Chuck is a unique high performance chuck that can also be used with standard collets.

- High runout accuracy: < 0.00012" (3µm) at 3 × D with HAIMER Power Collets
- Also for standard collets ER according to ISO 15488 (formerly DIN 6499)
(Attention: By using standard collet ER length A will increase)

- High rigidity
- Runs smoother thanks to vibration absorbing geometry, yielding better surface finish and increased tool, spindle and machine protection
- Highest cutting performance with higher spindle speeds, higher feeds and larger cutting depths
- Shorter cycle times, higher machining accuracy, higher clamping forces
- Equally suited to high-speed manufacturing and heavy milling
- With threaded holes for balancing screws
- Optional: Cool-Jet bores on Power Collets from ER 25 Ø 1/4"
- Program of Power Collets on pages 154 – 157

INCH	ER	16	25	32
	Ø D [inch]	1.1	1.65	1.97
	Clamping range [inch]	1/8"-3/8"	1/8"-5/8"	1/8"-3/4"
	L [inch] short	1.69	2.42	2.44
Gage length A [inch]	short	2.76	2.76	2.76
Order No.	40.720...	.16.3	.25.3	.32.3
	L [inch]	1.69	2.01	2.09
Gage length A [inch]	long	3.94	3.94	3.94
Order No.	40.721...	.16.3	.25.3	.32.3
Gage length A [inch]	oversize	6.30	6.30	6.30
Order No.	40.722...	.16.3	.25.3	.32.3

Accessories

Locknut (fine-balanced)

Size	ER 16	ER 25	ER 32
Order No. 83.914...	.16	.25	.32

Clamping wrench  See page 158

Torque Master torque wrench for Power Collet Chucks  See page 158

Order No. 84.600.00
 Power Collets  See page 154

Power Collets with Safe-Lock™ See page 156

Cool-Jet bores for Power Collets  See page 157
 Order No. 91.100.27

ER COLLET CHUCK
CAT 40 · ASME B5.50

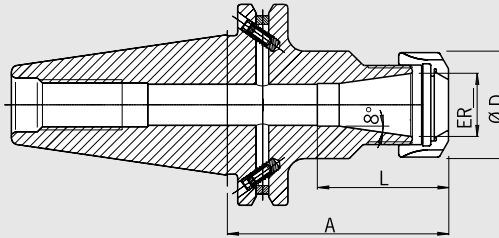

CERTIFICATE OF QUALITY

<input checked="" type="checkbox"/> Chuck fine balanced G2.5 22,000rpm or U<1gmm
<input checked="" type="checkbox"/> All functional surfaces machined
<input checked="" type="checkbox"/> Taper tolerance AT3
<input checked="" type="checkbox"/> Coolant supply form ADB

Use:

For clamping tools with cylindrical shank in ER collets according to ISO 15488.

– Balanced collet nuts with special slide coating for low friction and higher clamping forces

– Included in delivery: ER collet chuck with pre-balanced collet nut

CAT 40 FORM ADB

Form ADB means: central-coolant supply and coolant channels through the flange which can be sealed again

INCH	Ø ER		ER11	ER16	ER20	ER25	ER32	ER40
	Ø D [inch]		0.75	1.1	1.34	1.65	1.97	2.48
	Clamping range [inch]		0.02–0.28	0.02–0.39	0.04–0.51	0.04–0.63	0.04–0.79	0.08–1.02
	Clamping range [mm]		0.5–7.0	0.5–10.0	1.0–13.0	1.0–16.0	1.0–20.0	2.0–26.0
L [inch]			–	²⁾	1.63	2.44	2.52	2.87
Gage length A [inch]	short		–	2.76	2.76	2.76	2.76	2.76
Order No.	40.720...			.16	.20	.25	.32	.40
L [inch]			²⁾	²⁾	1.63	2.24	2.52	2.87
Gage length A [inch]	long		3.94	3.94	3.94	3.94	3.94	3.94
Order No.	40.721...		.11	.16	.20	.25	.32	.40
L [inch]			–	²⁾	1.63	2.24	2.52	2.87
Gage length A [inch]	oversize		–	6.30	6.30	6.30	6.30	6.30
Order No.	40.722...			.16	.20	.25	.32	.40
L [inch]			–	²⁾	1.63	2.24	2.52	–
Gage length A [inch]	ZG200		–	7.87	7.87	7.87	7.87	–
Order No.	40.726...			.16	.20	.25	.32	

Accessories

See accessories (pg. 143)

Spare parts Collet nut, Pre-balanced

Ø ER			ER11	ER16	ER20	ER25	ER32	ER40
Order No.	83.912...		.11	.16	.20	.25	.32	.40

Spare parts Collet nut HS (High-Speed), fine-balanced

Ø ER				ER16	ER20	ER25	ER32	ER40
Order No.	83.912...			.16.HS	.20.HS	.25.HS	.32.HS	.40.HS

Spare parts Wrench

Ø ER			ER11	ER16	ER20	–	–	–
Order No.	84.200...		.11	.16	.20			

Spare parts Wrench

Ø ER			–	–	–	ER25	ER32	ER40
Order No.	84.200...					.25	.32	.40

Spare parts Balancing index rings

Ø ER			ER11	ER16	ER20	ER25	ER32	ER40 ¹⁾
Order No.	79.350...		.19	.28	.34	.42	.1.71Z	.50

Spare parts Collet

Ø ER		
See accessories		

Spare parts Pull Studs

Ø ER		
See accessories		

FACE MILL ARBOR
CAT 40 · ASME B5.50

CERTIFICATE OF QUALITY

- Chuck fine balanced
G2.5 22,000rpm
or U<1gmm
- All functional surfaces machined
- Taper tolerance AT3
- Coolant supply form ADB

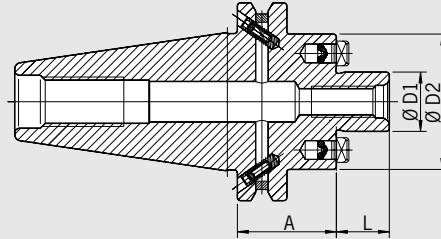

Use:

For clamping face-mill cutters

CAT 40 FORM ADB

Form ADB means: central-coolant supply and coolant channels through the flange which can be sealed again

– Included in delivery: Face Mill Arbor and clamping screw

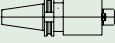
INCH	Ø D1 [inch]		3/4"	1"	1 1/4"	1 1/2"
	L [inch]		0.67	0.67	0.67	0.94
	Ø D2 [inch]		1.71	2.17	2.75	3.78
Gage length A [inch]	short		1.38	1.97	1.97	1.97
Order No.	40.750...		.3/4Z	.1Z	.1 1/4Z	.1 1/2Z
Gage length A [inch]	long		3.94	3.94	–	
Order No.	40.751...		.3/4Z	.1Z	–	

Accessories

See accessories (pg. 143)

Spare parts Clamping Screw

Ø D1 [inch]		3/4"	1"	1 1/4"	1 1/2"	
Order No.	85.300...		.3/4Z	.1Z	.11/4Z	.11/2Z

Spare parts Wrench

Ø D1 [inch]		3/4"	1"	1 1/4"	1 1/2"	
Order No.	84.400...		.3/4Z	.1Z	.11/4Z	.11/2Z

Spare parts Balancing index rings

Ø D1 [inch]		3/4"	1"	1 1/4"	1 1/2"	
Order No.	79.350...		.1.71Z	.55	.70	.96

Spare parts Pull Stud



Coolant bores

Order No.	91.100.03	
------------------	------------------	---

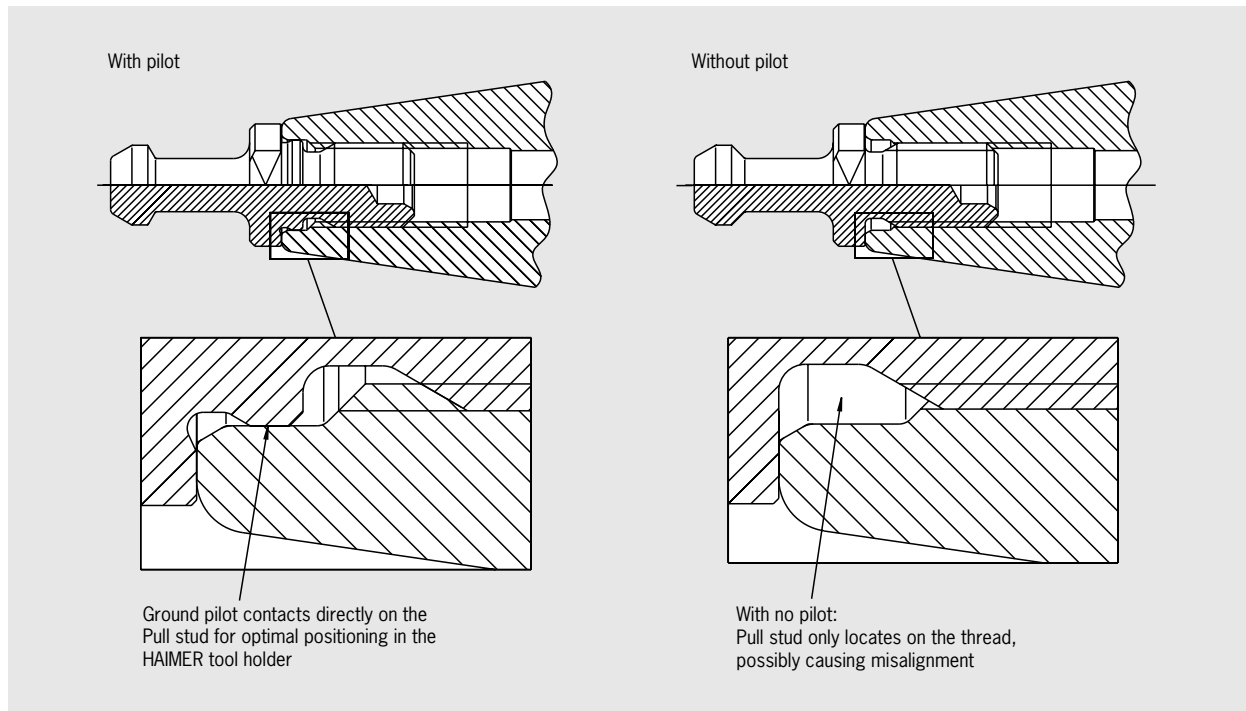

HAIMER goes far beyond the requirements of CAT 50 tooling. Our experience with tool holders and balancing have merged together to successfully create far superior CAT tapered tooling.

In addition to our unsurpassed taper contact and 100% inspection process of our tapers, HAIMER has developed a special feature to greatly increase your tool holder balance repeatability and your machine tool spindle draw mechanism repeatability.

We have added a ground pilot in the rear of all our CAT 50 tool holders. This ground pilot fits perfectly with the special HAIMER pull stud to maximize your tool holder to machine tool connection. The weight of a standard CAT 50 pull stud can easily throw out the balance of a pre-balanced tool holder, especially if it is locating only on the threads of the pull stud. The special HAIMER pull stud in conjunction with a CAT 50 HAIMER holder can greatly reduce this inconsistency in balance.

The ground pilot is larger than the standard ANSI dimension, so you can easily use any pull stud from any manufacturer. However, for those serious about balance and machine tool spindle draw repeatability, HAIMER has the answer for you!

SHRINK FIT CHUCK CAT 50 · ASME B5.50

CERTIFICATE OF QUALITY

- Chuck body fine balanced
G2.5 25,000 rpm
or U < 1 gmm
- All functional surfaces machined
- Taper tolerance AT3
- Coolant supply form ADB
- Cool-Jet, can be sealed

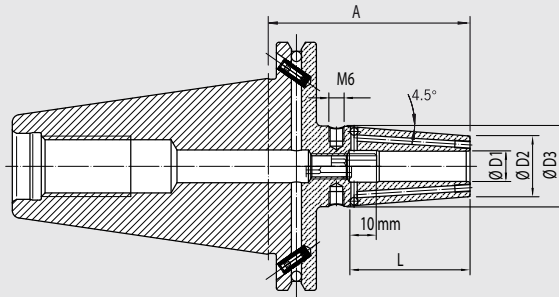

Use:

Shrink fit chuck suitable for use with all available shrink fit units.

CAT 50 FORM ADB

Form ADB means: central coolant supply and coolant channels through the flange which can be sealed again

- Heat resistant hot-working steel
- Hardened 54-2 HRC
- For HSS and solid carbide tools
- Shank tolerance h6
- With threaded holes for balancing screws
- Cool-Jet coolant bores that can be sealed included

Optional:

- Cooling with Cool Flash for an extra charge (See pp. 182/183)

INCH	Clamping Ø D1 [inch]		1/4"	5/16"	3/8"	7/16"	1/2"	5/8"	3/4"	7/8"	1"	1 1/4"
	Ø D2 [inch]		0.83	0.83	0.94	0.94	0.94	1.06	1.30	1.30	1.73	1.73
	Ø D3 [inch]		1.06	1.06	1.26	1.26	1.26	1.34	1.65	1.65	2.09	2.09
	L [inch]		1.42	1.42	1.65	1.65	1.85	1.97	2.05	2.05	2.28	2.28
Gage length A [inch]	short		3.15	3.15	3.15	3.15	3.15	3.15	3.15	3.15	3.94	3.94
Order No.	50.840...		.1/4Z.4	.5/16Z.4	.3/8Z.4	.7/16Z.4	.1/2Z.4	.5/8Z.4	.3/4Z.4	.7/8Z.4	.1Z.4	.1 1/4Z.4
Gage length A [inch]	ZG130		5.12	5.12	5.12	5.12	5.12	5.12	5.12	5.12	5.12	5.12
Order No.	50.844...		.1/4Z.4	.5/16Z.4	.3/8Z.4	.7/16Z.4	.1/2Z.4	.5/8Z.4	.3/4Z.4	.7/8Z.4	.1Z.4	.1 1/4Z.4
Gage length A [inch]	oversize		6.30	6.30	6.30	6.30	6.30	6.30	6.30	6.30	6.30	6.30
Order No.	50.842...		.1/4Z.4	.5/16Z.4	.3/8Z.4	.7/16Z.4	.1/2Z.4	.5/8Z.4	.3/4Z.4	.7/8Z.4	.1Z.4	.1 1/4Z.4

METRIC	Clamping Ø D1 [mm]		06	08	10	12	14	16	18	20	25	32
	Ø D2 [mm]		21	21	24	24	27	27	33	33	44	44
	Ø D3 [mm]		27	27	32	32	34	34	42	42	53	53
	L [mm]		36	36	42	47	47	50	50	52	58	58
Gage length A [mm]	short		80	80	80	80	80	80	80	80	100	100
Order No.	50.840...		.06.4	.08.4	.10.4	.12.4	.14.4	.16.4	.18.4	.20.4	.25.4	.32.4
Gage length A [mm]	ZG130		130	130	130	130	130	130	130	130	130	130
Order No.	50.844...		.06.4	.08.4	.10.4	.12.4	.14.4	.16.4	.18.4	.20.4	.25.4	.32.4
Gage length A [mm]	oversize		160	160	160	160	160	160		160	160	160
Order No.	50.842...		.06.4	.08.4	.10.4	.12.4	.14.4	.16.4		.20.4	.25.4	.32.4

Accessories

Cool Flash



Order No. 91.100.40

See pages 182/183

POWER SHRINK CHUCK
CAT 50 · ASME B5.50

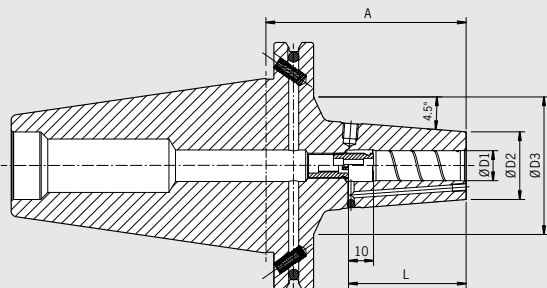

CERTIFICATE OF QUALITY	
<input checked="" type="checkbox"/>	Chuck body fine balanced G2.5 25,000 rpm or U < 1 gmm
<input checked="" type="checkbox"/>	All functional surfaces machined
<input checked="" type="checkbox"/>	Taper tolerance AT3
<input checked="" type="checkbox"/>	Coolant supply form ADB
<input checked="" type="checkbox"/>	Cool-Jet, can be sealed

The Power Shrink Chuck is designed for the highest cutting performance in high-speed manufacturing. The optimized design combines high rigidity with vibration dampening, which protects the machine, spindle and tool.

- Highest cutting performance with higher spindle speeds, higher feeds and larger cutting depths
- Shorter cycle times, higher machining accuracy
- Quieter running, therefore better surface quality and protection of tools, spindles and machines
- With threaded holes for balancing screws
- Cool-Jet coolant bores that can be sealed included

The long versions (A=160 and 200) with slim tips are especially versatile to use.

- High rigidity, slim at the tip, dampen vibrations
- Higher clamping forces
- Equally suited to high-speed manufacturing and heavy milling
- Universal usage, saves space in tool magazine

Optional:

- Cooling with Cool Flash for an extra charge (See pp. 182/183)
- Safe-Lock™ Pull out protection (See pages 184-187)

INCH	Clamping Ø D1 [inch]		1/4"	5/16"	3/8"	1/2"	5/8"	3/4"	1"
	Ø D2 [inch] short		0.83	0.83	1.06	1.06	1.31	1.76	1.73
	Ø D3 [inch] short		2.68	2.68	2.17	2.17	—	—	—
	L [inch]		1.42	1.42	1.65	1.85	1.97	2.05	2.28
Gage length A [inch]	short		3.15	3.15	3.15	3.15	3.15	3.15	3.94
Order No.	50.840...		.1/4z.3	.5/16z.3	.3/8z.3	.1/2z.3	.5/8z.3	.3/4z.3	.1z.3
Safe-Lock™ Order No.	50.840...		.1/4z.37	.5/16z.37	.3/8z.37	.1/2z.37	.5/8z.37	.3/4z.37	.1z.37
	Ø D2 [inch] oversize/ZG200		0.83	0.83	1.06	1.06	1.30	1.73	1.73
	Ø D3 [inch] oversize/ZG200		2.75	2.75	2.75	2.75	2.75	2.75	2.75
Gage length A [inch]	oversize		6.30	6.30	6.30	6.30	6.30	6.30	6.30
Order No.	50.842...		.1/4z.3	.5/16z.3	.3/8z.3	.1/2z.3	.5/8z.3	.3/4z.3	.1z.3
Safe-Lock™ Order No.	50.842...		.1/4z.37	.5/16z.37	.3/8z.37	.1/2z.37	.5/8z.37	.3/4z.37	.1z.37
Gage length A [inch]	ZG200		7.87	7.87	7.87	7.87	7.87	7.87	7.87
Order No.	50.846...		.1/4z.3	.5/16z.3	.3/8z.3	.1/2z.3	.5/8z.3	.3/4z.3	.1z.3
Safe-Lock™ Order No.	50.846...		.1/4z.37	.5/16z.37	.3/8z.37	.1/2z.37	.5/8z.37	.3/4z.37	.1z.37

METRIC	Ø D1 [mm]		06	08	10	12	14	16	18	20	25
	Ø D2 [mm] short		21	21	27	27	33.3	33.3	44.7	44.7	44
	Ø D3 [mm] short		68	68	55	55	—	—	—	—	—
	L [mm]		36	36	42	47	47	50	50	52	58
Gage length A [mm]	short		80	80	80	80	80	80	80	80	100
Order No.	50.840...		.06.3	.08.3	.10.3	.12.3	.14.3	.16.3	.18.3	.20.3	.25.3
Safe-Lock™ Order No.	50.840...		.06.37	.08.37	.10.37	.12.37	.14.37	.16.37	.18.37	.20.37	.25.37
	Ø D2 [mm] oversize/ZG200		21	21	27	27	33	33	44	44	44.7
	Ø D3 [mm] oversize/ZG200		69.85	69.85	69.85	69.85	69.85	69.85	69.85	69.85	69.85
Gage length A [mm]	oversize		160	160	160	160	160	160	160	160	160
Order No.	50.842...		.06.3	.08.3	.10.3	.12.3	.14.3	.16.3	.18.3	.20.3	.25.3
Safe-Lock™ Order No.	50.842...		.06.37	.08.37	.10.37	.12.37	.14.37	.16.37	.18.37	.20.37	.25.37
Gage length A [mm]	ZG200		200	200	200	200	200	200	200	200	200
Order No.	50.846...		.06.3	.08.3	.10.3	.12.3	.14.3	.16.3	.18.3	.20.3	.25.3
Safe-Lock™ Order No.	50.846...		.06.37	.08.37	.10.37	.12.37	.14.37	.16.37	.18.37	.20.37	.25.37

HEAVY DUTY CHUCK CAT 50 · ASME B5.50



CERTIFICATE OF QUALITY

- Chuck body fine balanced
G2.5 25,000 rpm
or U < 1 gmm
- All functional surfaces machined
- Taper tolerance AT3
- Coolant supply form ADB
- Cool-Jet, can be sealed

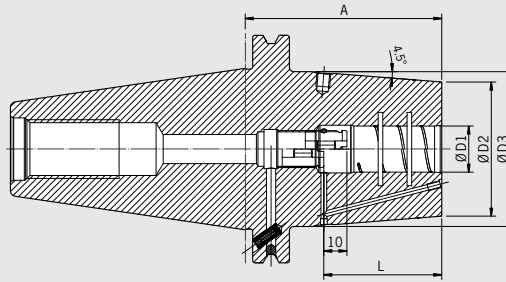

Finally there is a holder for heavy machining that can replace the Weldon tool holder. The Heavy Duty Chuck is a shrink fit chuck designed for extreme cases. The contour is optimized for highest rigidity and clamping force.



- Smooth clamping of the tool shank
- TIR less than 0.00012" (3 µm)
- Reinforced outer contour
- To shrink with high performance shrink fit unit
HAIMER Power Clamp Profi Plus (20 kW)

- With internal groove in the clamping bore
- Cool-Jet coolant bores that can be sealed included
- With threaded holes for balancing screws

Optional:

- Cooling with Cool Flash from 5/8" – 1" for an extra charge (See pp. 182/183)
- Safe-Lock™ Pull out protection (See pages 184–187)

INCH	Clamping Ø D1 [inch]		5/8"	3/4"	1"	1 1/4"	1 1/2"	2"
	Ø D2 [inch]		2.01	2.28	2.48	2.76	3.23	3.23
	Ø D3 [inch]		—	2.64	—	3.07	3.54	3.70
	L [inch]		1.97	2.05	2.28	2.40	3.46	3.46
Gage length A [inch]	short		3.15	3.35	3.54	3.54	3.94	5.51
Order No.	50.850...		.5/8z.6	.3/4z.6	.1z.6	.11/4z.6	.11/2z.6	.2z.6
Safe-Lock™ Order No.	50.850...		.5/8z.67	.3/4z.67	.1z.67	.11/4z.67	.11/2z.67	.2z.67

METRIC	Clamping Ø D1 [mm]		16	20	25	32	40	50
	Ø D2 [mm]		51	58	63	70	82	82
	Ø D3 [mm] short		—	67	—	78	90	94
	L [mm]		50	52	58	61	88	88
Gage length A [mm]	short		80	85	90	90	100	140
Order No.	50.850...		.16.6	.20.6	.25.6	.32.6	.40.6	.50.6
Safe-Lock™ Order No.	50.850...		.16.67	.20.67	.25.67	.32.67	.40.67	.50.67
	Ø D3 [mm] oversize/ZG200		69.85	69.85	78	85	94	94
Gage length A [mm]	oversize		160	160	160	160	160	160
Order No.	50.852...		.16.6	.20.6	.25.6	.32.6	.40.6	.50.6
Safe-Lock™ Order No.	50.852...		.16.67	.20.67	.25.67	.32.67	.40.67	.50.67
Gage length A [mm]	ZG200		200	200	200	200	200	200
Order No.	50.856...		.16.6	.20.6	.25.6	.32.6	.40.6	.50.6
Safe-Lock™ Order No.	50.856...		.16.67	.20.67	.25.67	.32.67	.40.67	.50.67

Accessories

Cool Flash



Order No. 91.100.40

See pages 182/183

POWER COLLET CHUCK
CAT 50 · ASME B5.50

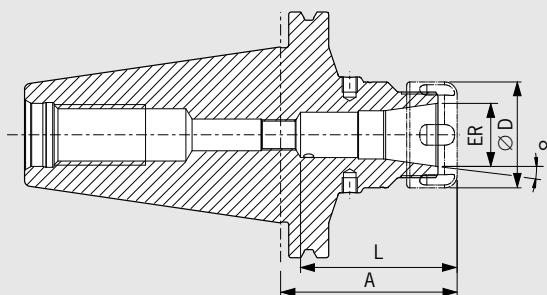





CERTIFICATE OF QUALITY	
<input checked="" type="checkbox"/>	Chuck body fine balanced G2.5 25,000 rpm
<input checked="" type="checkbox"/>	All functional surfaces fine-machined
<input checked="" type="checkbox"/>	Taper tolerance AT3
<input checked="" type="checkbox"/>	Coolant supply form ADB

The Power Collet Chuck is designed for the highest machining capacity in high-speed manufacturing. The optimized design with improved construction combines high rigidity with vibration dampening features, giving more protection to the machine, spindle and tool.

The universal Power Collet Chuck is a unique high performance chuck that can also be used with standard collets.

- High runout accuracy: < 0.00012" (3µm) at 3 × D with HAIMER Power Collets
- Also for standard collets ER according to ISO 15488 (formerly DIN 6499) (Attention: By using standard collet ER length A will increase)
- High rigidity

- Runs smoother thanks to vibration absorbing geometry, yielding better surface finish and increased tool, spindle and machine protection
- Highest cutting performance with higher spindle speeds, higher feeds and larger cutting depths
- Shorter cycle times, higher machining accuracy, higher clamping forces
- Equally suited to high-speed manufacturing and heavy milling
- With threaded holes for balancing screws
- Optional: Cool-Jet bores on Power Collets from ER 25 Ø 1/4"
- Program of Power Collets on pages 154 – 157

INCH	ER		16	25	32
	Ø D [inch]		1.1	1.65	1.97
	Clamping range [inch]		1/8"-3/8"	1/8"-5/8"	1/8"-3/4"
	L [inch] short		1.69	2.44	2.46
Gage length A [inch]	short		2.76	2.76	2.76
Order No.	50.720...		.16.3	.25.3	.32.3
	L [inch]		1.69	2.01	2.09
Gage length A [inch]	long		3.94	3.94	3.94
Order No.	50.721...		.16.3	.25.3	.32.3
Gage length A [inch]	ZG130		5.12	5.12	5.12
Order No.	50.724...		.16.3	.25.3	.32.3
Gage length A [inch]	oversize		6.30	6.30	6.30
Order No.	50.722...		.16.3	.25.3	.32.3

Accessories

Locknut (fine-balanced)

Size		ER 16	ER 25	ER 32
Order No. 83.914...		.16	.25	.32

Clamping wrench See page 158

Torque Master torque wrench for Power Collet Chucks See page 158

Order No. 84.600.00 

Power Collets See page 154

Power Collets with Safe-Lock™ See page 156

Cool-Jet bores for Power Collets See page 157

Order No. 91.100.27

ER COLLET CHUCK
CAT 50 · ASME B5.50

CERTIFICATE OF QUALITY

- Chuck body fine balanced
G2.5 25,000rpm
or U<1gmm
- All functional surfaces machined
- Taper tolerance AT3
- Coolant supply form ADB

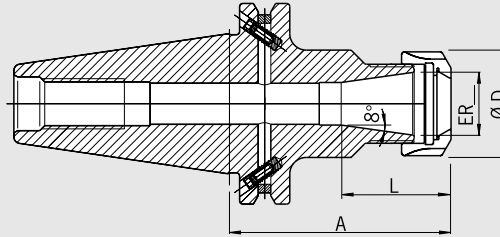

ASME B5.50

Use:

For clamping tools with cylindrical shank in ER collets according to ISO 15488.

CAT 50 FORM ADB

Form ADB means: central-coolant supply and coolant channels through the flange which can be sealed again

- Balanced collet nuts with special slide coating for low friction and higher clamping forces
- Included in delivery: ER collet chuck with pre-balanced collet nut

INCH	ER	ER16	ER20	ER25	ER32	ER40
	Ø D [inch]	1.1	1.34	1.65	1.97	2.48
	Clamping range [inch]	0.02-0.39	0.04-0.51	0.04-0.63	0.04-0.79	0.08-1.02
	Clamping range [mm]	0.5-10.0	1.0-13.0	1.0-16.0	1.5-20.0	2.5-26.0
L [inch]		4)	1.63	2.44	2.52	2.87
Gage length A [inch]	short	2.76	2.76	2.76	2.76	2.76
Order No.	50.720...	.16	.20	.25	.32	.40
L [inch]		4)	1.63	2.24	2.52	2.87
Gage length A [inch]	long	3.94	3.94	3.94	3.94	3.94
Order No.	50.721...	.16	.20	.25	.32	.40
L [inch]		4)	1.63	2.24	2.52	2.87
Gage length A [inch]	oversize	6.30	6.30	6.30	6.30	6.30
Order No.	50.722...	.16	.20	.25	.32	.40

Accessories

See accessories (pg. 143)

Spare parts Collet nut, Pre-balanced

Ø ER	ER16	ER20	ER25	ER32	ER40
Order No. 83.912...	.16	.20	.25	.32	.40

Spare parts Collet nut HS (Highspeed), fine-balanced

Ø ER	ER16	ER20	ER25	ER32	ER40
Order No. 83.912...	.16.HS	.20.HS	.25.HS	.32.HS	.40.HS

Spare parts Wrench

Ø ER	ER16	ER20	ER25	ER32	ER40
Order No. 84.200...	.16	.20	-	-	-

Spare parts Wrench

Ø ER	ER25	ER32	ER40
Order No. 84.200...	.25	.32	.40

Spare parts Balancing index rings

Ø ER	ER16	ER20	ER25 ¹⁾	ER32 ²⁾	ER40 ³⁾
Order No. 79.350...	.28	.34	.42	.48	.63

Spare parts Collet

Ø ER	See accessories
See accessories	

Spare parts Pull Studs

Ø ER	See accessories
See accessories	

1) Not for 50.720.25 2) Not for 50.720.32 3) Not for 50.720.40 4) Drilled through

FACE MILL ARBOR
CAT 50 · ASME B5.50

ASME B5.50

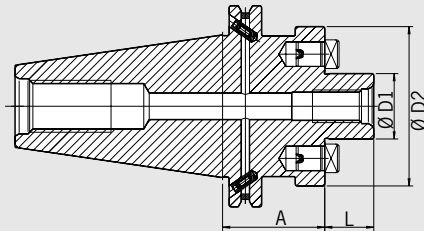

CERTIFICATE OF QUALITY

- Chuck body fine balanced
G2.5 22,000 rpm
or U<1gmm
- All functional surfaces machined
- Taper tolerance AT3
- Coolant supply form ADB

Use:

For clamping face-mill cutters

CAT 50 FORM ADB



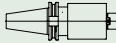

Form ADB means: central coolant supply and coolant channels through the flange which can be sealed again

– Included in delivery: Face Mill Arbor and clamping screw

INCH	Ø D1 [inch]		3/4"	1"	1 1/4"	1 1/2"
	L [inch]		0.67	0.67	0.67	0.94
	Ø D2 [inch]		1.71	2.17	2.71	3.78
Gage length A [inch]	short		1.38	1.38	1.38	2.36
Order No.	50.750...		.3/4Z	.1Z	.1 1/4Z	.1 1/2Z
Gage length A [inch]	long		3.94	3.94	–	–
Order No.	50.751...		.3/4Z	.1Z	–	–

Accessories

See accessories (pg. 143)

Spare parts Clamping Screw						
Ø D1 [inch]			3/4"	1"	1 1/4"	1 1/2"
Order No.	85.300...		.3/4Z	.1Z	.11/4Z	.11/2Z
Spare parts Wrench						
Ø D1 [inch]			3/4"	1"	1 1/4"	1 1/2"
Order No.	84.400...		.3/4Z	.1Z	.11/4Z	.11/2Z
Spare parts Balancing index rings						
Ø D1 [inch]			3/4"	1"	–	–
Order No.	79.350...		.1.71Z	.55		
Spare parts Pull Studs						
						
Coolant bores						
Order No.	91.100.03					

BT 30 BT 40 BT 50

BT 30/JIS B 6339

Shrink Fit Chuck	40
Power Mini Shrink	41
Power Collet Chuck	42
ER Collet Chuck	43
Face Mill Arbor	44

BT 40/JIS B 6339

Shrink Fit Chuck	45
Power Shrink Chuck	47
Power Mini Shrink	48
Power Collet Chuck	49
ER Collet Chuck	50
HG Collet Chuck	52
Face Mill Arbor	53
Adapter for morse taper with thread	54
Adapter for morse taper with tang	55

BT 50/JIS B 6339

Shrink Fit Chuck	56
Power Shrink Chuck	57
Heavy Duty Chuck	58
Power Collet Chuck	59
ER Collet Chuck	60
HG Collet Chuck	61
Face Mill Arbor	62
Adapter for morse taper with thread	63
Adapter for morse taper with tang	64
Blank Adapter	65

SHRINK FIT CHUCK
BT30 · JIS B 6339

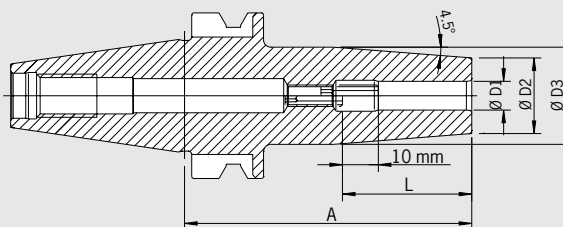

CERTIFICATE OF QUALITY

- Chuck fine balanced
G2.5 25,000rpm
or U<1gmm
- All functional surfaces machined
- Taper tolerance AT3

Use:

Shrink fit chuck suitable for use with all available shrink fit units.

- Heat resistant hot-working steel
- Hardened 54-2 HRC
- For HSS and solid carbide tools
- Shank tolerance h6
- Included in delivery: with back-up screw
- With threaded holes for balancing screws

JIS B 6339 BT30 FORM AD

Optional:

- Cooling with Cool-Jet and Cool Flash for an extra charge (See pp. 182/183)

Short

INCH	Clamping Ø D1 [inch]	1/8"	3/16"	1/4"	5/16"	3/8"	7/16"	1/2"	5/8"	3/4"
	Ø D2 [inch]	0.39	0.39	0.83	0.83	0.94	0.94	0.94	1.06	1.30
	Ø D3 [inch]	—	—	1.06	1.06	1.26	1.26	1.26	1.34	1.65
	L [inch]	0.35	0.59	1.42	1.42	1.65	1.65	1.85	1.97	2.05
Gage Length A [inch]	short	3.15 ¹⁾	3.15 ¹⁾	3.15	3.15	3.15	3.15	3.15	3.15	3.54
Order No.	30.640...	.1/8Z	.3/16Z	.1/4Z	.5/16Z	.3/8Z	.7/16Z	.1/2Z	.5/8Z	.3/4Z

Standard version, similar to DIN 69882-8

METRIC	Clamping Ø D1 [mm]	03	04	05	06	08	10	12	14	16	18	20
	Ø D2 [mm]	10	10	10	21	21	24	24	27	27	33	33
	Ø D3 [mm]	—	—	—	27	27	32	32	34	34	40.5	40.5
	L [mm]	09	12	15	36	36	42	47	47	50	50	52
Gage Length A [mm]	short	80 ¹⁾	80 ¹⁾	80 ¹⁾	80	80	80	80	80	80	90	90
Order No.	30.640...	.03	.04	.05	.06	.08	.10	.12	.14	.16	.18	.20

Ultra Short

INCH	Clamping Ø D1 [inch]	1/8"	3/16"	1/4"	5/16"	3/8"	7/16"	1/2"	5/8"	3/4"
	Ø D2 [inch]	0.39	0.39	0.91	0.91	1.06	1.06	1.06	1.18	1.39
	L [inch]	0.35	0.59	1.42	1.42	1.65	1.65	1.85	1.97	2.05
Gage Length A [inch]	ultra short	2.36 ¹⁾	2.36 ¹⁾	2.36	2.36	2.36	2.36	2.36	2.56	2.75
Order No.	30.645...	.1/8Z	.3/16Z	.1/4Z	.5/16Z	.3/8Z	.7/16Z	.1/2Z	.5/8Z	.3/4Z

Ultra Short

METRIC	Clamping Ø D1 [mm]	03	04	05	06	08	10	12	14	16	18	20
	Ø D2 [mm]	10	10	10	23	23	27	27	30	30	35.5	35.5
	Ø D3 [mm]	—	—	—	—	—	—	—	—	—	40.5	40.5
	L [mm]	09	12	15	36	36	42	47	47	50	50	52
Gage Length A [mm]	ultra short	60 ¹⁾	60 ¹⁾	60 ¹⁾	60 ²⁾	60 ²⁾	60 ²⁾	60 ²⁾	65 ²⁾	65 ²⁾	70 ²⁾	70 ²⁾
Order No.	30.645...	.03	.04	.05	.06	.08	.10	.12	.14	.16	.18	.20

1) Without back-up screw, without threads for balancing screws, with slits along the clamping bore for cooling from outside

2) Without threads for balancing screws

Accessories

Cool Flash

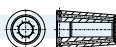

Order No. 91.100.40

See pages 182/183

POWER MINI SHRINK CHUCK
BT30 · JIS B 6339

CERTIFICATE OF QUALITY

- ☑ Chuck fine balanced
G2.5 25,000 rpm
or U < 1 gmm
- ☑ All functional surfaces machined
- ☑ Taper tolerance AT3
- ☑ Coolant supply form AD

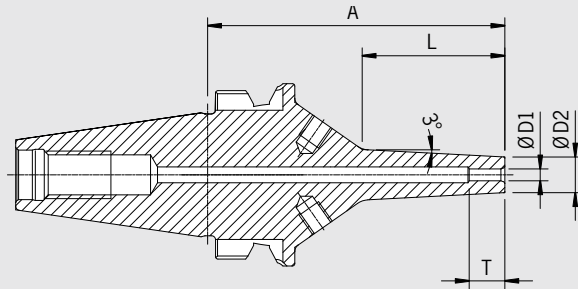

Power Mini Shrink Chuck is perfect for 5-axis-machining in the die & mold and in the medical industry. Very slim at the top like the HAIMER Mini Shrink Chucks, the Power Mini Shrink is reinforced at the base. This allows for efficient milling with an angled tool even at long protruding lengths.



- 3° slope at the top
- With threaded holes for balancing screws
- For solid carbide tools with shank tolerance h6
- **Attention: Shrinking only with shrink and cooling sleeves**

CERTIFICATE OF QUALITY

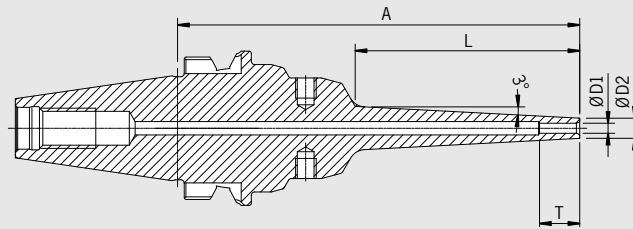
- ☑ Chuck fine balanced
G2.5 25,000 rpm
or U < 1 gmm
- ☑ All functional surfaces machined
- ☑ Taper tolerance AT3
- ☑ Coolant supply form AD

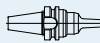

BT30

METRIC	Clamping Ø D1 [mm]		03	04	06	08	10	12
	T [mm]		—	—	—	—	68	75
	Ø D2 [mm] short		09	10	12	14	16	18
	L [mm] short		36	36	36	36	36	36
Gage Length A [mm]	short		75	75	75	75	75	75
Order No.	30.680...		.03.8	.04.8	.06.8	.08.8	.10.8	.12.8
	Ø D2 [mm] ZG95		06	07	09	—	—	—
	L [mm] ZG95		42	42	42	—	—	—
Gage Length A [mm]	ZG95		95	95	95	—	—	—
Order No.	30.671...		.03.8	.04.8	.06.8	—	—	—
	Ø D2 [mm] ZG120		06	07	09	—	—	—
	L [mm] ZG120		67	67	67	—	—	—
Gage Length A [mm]	ZG120		120	120	120	—	—	—
Order No.	30.677...		.03.8	.04.8	.06.8	—	—	—

Accessories

Shrink and cooling adapter for Mini Shrink

POWER COLLET CHUCK
BT30 · JIS B 6339

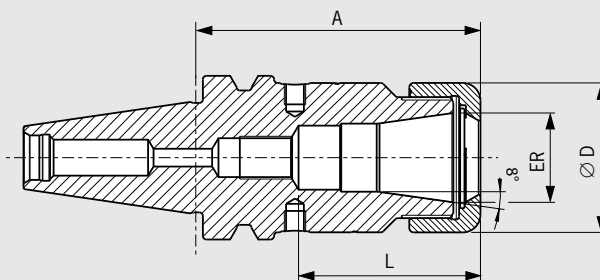

CERTIFICATE OF QUALITY

- Chuck body fine balanced
G2.5 25,000 rpm
- All functional surfaces fine-machined
- Taper tolerance AT3
- Coolant supply form ADB

The Power Collet Chuck is designed for the highest machining capacity in high-speed manufacturing. The optimized design with improved construction combines high rigidity with vibration dampening features, giving more protection to the machine, spindle and tool. The universal Power Collet Chuck is a unique high performance chuck that can also be used with standard collets.

- High runout accuracy: < 0.00012" (3µm) at 3 x D with HAIMER Power Collets
- Also for standard collets ER according to ISO 15488 (formerly DIN 6499)
(Attention: By using standard collet ER length A will increase)

- High rigidity
- Runs smoother thanks to vibration absorbing geometry, yielding better surface finish and increased tool, spindle and machine protection
- Highest cutting performance with higher spindle speeds, higher feeds and larger cutting depths
- Shorter cycle times, higher machining accuracy, higher clamping forces
- Equally suited to high-speed manufacturing and heavy milling
- With threaded holes for balancing screws
- Optional: Cool-Jet bores on Power Collets from ER 25 Ø 1/4"
- Program of Power Collets on pages 154 – 157

INCH	ER		16	25	32
	Ø D [inch]		1.1	1.65	1.97
	Clamping range [inch]		1/8"-3/8"	1/8"-5/8"	1/8"-3/4"
	L [inch]		1.69	2.01	2.08
Gage length A [inch]	ultra short		2.16 ¹⁾	2.1 ¹⁾	2.16 ¹⁾
Order No.	30.525...		.16.3	.25.3	.32.3
Gage length A [inch]	short		3.15	3.15	3.15
Order No.	30.520...		.16.3	.25.3	.32.3

Accessories

Locknut (fine-balanced)

Size		ER 16	ER 25	ER 32
Order No. 83.914...		.16	.25	.32

Clamping wrench See page 158

Torque Master torque wrench for Power Collet Chucks

Order No. 84.600.00 See page 158

Power Collets See page 154

Power Collets with Safe-Lock™ See page 156

Cool-Jet bores for Power Collets See page 157
Order No. 91.100.27

ER COLLET CHUCK BT30 · JIS B 6339

CERTIFICATE OF QUALITY

- Chuck body fine balanced
G2.5 25,000 rpm
- All functional surfaces fine-machined
- Taper tolerance AT3

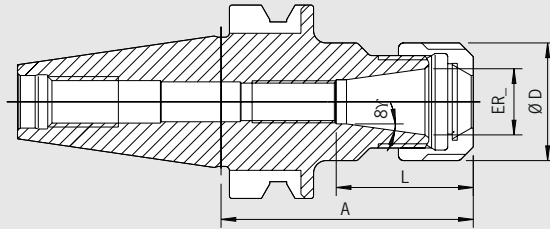

Use:

For clamping tools with cylindrical shank in ER collets according to ISO 15488.

JIS B 6339 BT 30

- Included in delivery: Locknut type HS (High-Speed, fine balanced, with slide coating for higher clamping forces)
- Increasing size L possible upon request

INCH	ER		11	16	20	25
	Ø D [inch]		0.75	1.10	1.34	1.65
	Clamping range [inch]		0.02-0.28	0.02-0.39	0.04-0.51	0.04-0.63
	L [inch]		1.04	1.28	1.51	1.61
Gage Length A [inch]	ultra short		1.97	1.97	1.97	—
Order No.	30.525...		.11	.16	.20	
Gage Length A [inch]	short		2.36	2.36	2.36	2.36
Order No.	30.520...		.11	.16	.20	.25
Gage Length A [inch]	ZG80		—	3.15	3.15	3.15
Order No.	30.523...			.16	.20	.25
Gage Length A [inch]	ZG90		—	3.54	3.54	3.54
Order No.	30.528...			.16	.20	.25
Gage Length A [inch]	long		3.94	3.94	3.94	3.94
Order No.	30.521...		.11	.16	.20	.25

Accessories

See accessories (pg. 143)

Spare parts Collet nut, Pre-balanced

Ø ER		ER11	ER16	ER20	ER25
Order No.	83.912...	.11	.16	.20	.25

Spare parts Collet nut HS (High-Speed), fine-balanced

Ø ER		ER16	ER20	ER25
Order No.	83.912...	.16.HS	.20.HS	.25.HS

Spare parts Wrench

Ø ER		ER11	ER16	ER20	—
Order No.	84.200...	.11	.16	.20	

Spare parts Wrench

Ø ER		—	—	ER25
Order No.	84.200...			.25

Spare parts Collet

Ø ER	
See accessories	

Spare parts Pull Studs

Ø ER	
See accessories	

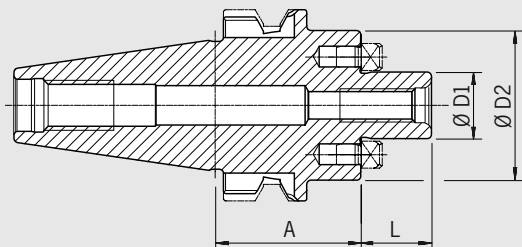

CERTIFICATE OF QUALITY	
<input checked="" type="checkbox"/>	Chuck body fine balanced G2.5 22,000 rpm
<input checked="" type="checkbox"/>	All functional surfaces machined
<input checked="" type="checkbox"/>	Taper tolerance AT3

Use:

For holding face mill cutters and milling cutters with radial driving slot
DIN 1880.

With coolant exit bores on the end face for milling cutters with central cooling.

Similar to DIN 6357 with taper **JIS B 6339 BT30 form AD**.

– Included in delivery: complete with tightening bolt

METRIC	Clamping Ø D1 [mm]	16	22	27
	Ø D2 [mm]	36	42	42
	L [mm]	17	19	21
Gage length A [mm]	short	35	35	35
Order No.	30.550...	.16.KKB	.22.KKB	.27.KKB

Accessories

Tightening bolt

Size D1	16	22	27	
Order No.	85.300...	.16	.22	.27

Wrench

Size D1	16	22	27	
Order No.	84.400...	.16	.22	.27

Pull studs

Coolant bores

Order No.	91.100.03			
-----------	-----------	--	--	--

SHRINK FIT CHUCK BT40 · JIS B 6339 INCH VERSION

CERTIFICATE OF QUALITY

- Chuck body fine balanced
G2.5 25,000 rpm
or U<1 gmm
- All functional surfaces machined
- Taper tolerance AT3
- Coolant supply form ADB
- Cool-Jet, can be sealed

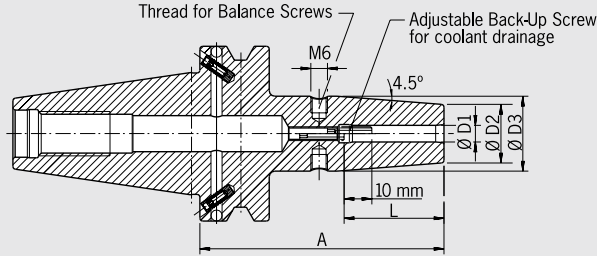

Use:

Shrink fit chuck suitable for use with all available shrink fit units.

JIS B 6339 BT 40 FORM ADB

Form ADB means: central coolant supply and coolant channels through the flange which can be sealed again

- Heat resistant hot-working steel
- Hardened 54-2 HRC

- For HSS and solid carbide tools
- Shank tolerance h6
- Included in delivery: Shrink fit chuck with back-up screw
- With threaded holes for balancing screws
- Cool-Jet bores that can be sealed included

Optional:

- Cooling with Cool Flash from ¼"-1" for an extra charge (See pp. 182/183)

Standard version

INCH	Clamping Ø D1 [inch]	1/8"	3/16"	1/4"	5/16"	3/8"	7/16"	1/2"	5/8"	3/4"	7/8"	1"	1 1/4"
	Ø D2 [inch]	0.39	0.39	0.83	0.83	0.94	0.94	0.94	1.06	1.30	1.30	1.73	1.73
	Ø D3 [inch]	-	-	1.06	1.06	1.26	1.26	1.26	1.34	1.65	1.65	2.09	2.09
	L [inch]	0.35	0.47	1.42	1.42	1.65	1.65	1.85	1.97	2.05	2.05	2.28	2.28
	Gage length A [inch] short	3.54 ¹⁾	3.54 ¹⁾	3.54	3.54	3.54	3.54	3.54	3.54	3.54	3.54	3.94	3.94
	Order No. 40.640...	.1/8Z	.3/16Z	.1/4Z.4	.5/16Z.4	.3/8Z.4	.7/16Z.4	.1/2Z.4	.5/8Z.4	.3/4Z.4	.7/8Z.4	.1Z.4	.1 1/4Z.4
	Gage length A [inch] ZG130	-	-	5.12	5.12	5.12	5.12	5.12	5.12	5.12	5.12	5.12	5.12
	Order No. 40.644...	-	-	.1/4Z.4	.5/16Z.4	.3/8Z.4	.7/16Z.4	.1/2Z.4	.5/8Z.4	.3/4Z.4	.7/8Z.4	.1Z.4	.1 1/4Z.4
	Gage length A [inch] oversize	-	-	6.30	6.30	6.30	6.30	6.30	6.30	6.30	6.30	6.30	6.30
	Order No. 40.642...	-	-	.1/4Z.4	.5/16Z.4	.3/8Z.4	.7/16Z.4	.1/2Z.4	.5/8Z.4	.3/4Z.4	.7/8Z.4	.1Z.4	.1 1/4Z.4

Standard version with Safe-Lock™ and M3 seal screw installed

INCH	Clamping Ø D1 [inch]	1/4"	5/16"	3/8"	1/2"	5/8"	3/4"	1"	1 1/4"
	Ø D2 [inch]	0.83	0.83	0.94	0.94	1.06	1.30	1.73	1.73
	Ø D3 [inch]	1.06	1.06	1.26	1.26	1.34	1.65	2.09	2.09
	L [inch]	1.42	1.42	1.65	1.85	1.97	2.05	2.28	2.28
	Gage length A [inch] short	3.54 ²⁾	3.54 ²⁾	3.54 ²⁾	3.54 ²⁾	3.54 ²⁾	3.54 ²⁾	3.94 ²⁾	3.94 ²⁾
	Order No. 40.640...	.1/4Z.47	.5/16Z.47	.3/8Z.47	.1/2Z.47	.5/8Z.47	.3/4Z.47	.1Z.47	.1 1/4Z.47

Accessories

See accessories (pg. 143)

Spare parts Pull Studs



Spare parts Reduction Sleeves for small shanks



Spare parts Balance Screws



Spare parts Back-up screws



Shrink fit extensions



Cool Flash

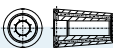

Order No. 91.100.40

See pages 182/183

1) Without back-up screw, without threads for balancing screws, with slits along the clamping bore for coolant around the tool Technical data and availability subject to change without prior notice
2) With tension spring

SHRINK FIT CHUCK
BT40 · JIS B 6339
METRIC VERSION

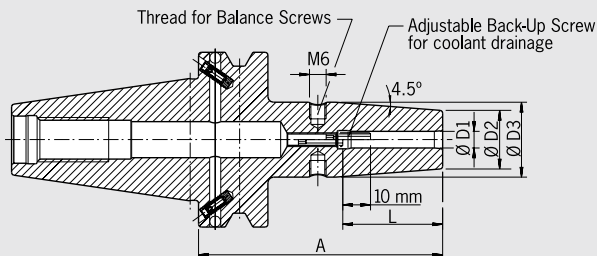

CERTIFICATE OF QUALITY

- Chuck body fine balanced G2.5 25,000 rpm
- All functional surfaces machined
- Taper tolerance AT3
- Coolant supply form ADB

Use:

Shrink fit chuck suitable for use with all available shrink fit units.

JIS B 6339 **BT 40 FORM ADB**

Form ADB means: central coolant supply and coolant channels through the flange which can be sealed again

- Heat resistant hot-working steel
- Hardened 54-2 HRC

- For HSS and solid carbide tools

- Shank tolerance h6

- Included in delivery: Shrink fit chuck with back-up screw

- With threaded holes for balancing screws

Optional:

- Cooling with Cool-Jet for an extra charge

- Cooling with Cool Flash for an extra charge (See pp. 182/183)

Standard version, similar to DIN 69882-8

METRIC	Clamping Ø D1 [mm]		03	04	05	06	08	10	12	14	16	18	20	25	32
	Ø D2 [mm]		10	10	10	21	21	24	24	27	27	33	33	44	44
	Ø D3 [mm]		—	—	—	27	27	32	32	34	34	42	42	53	53
	L [mm]		9	12	15	36	36	42	47	47	50	50	52	58	58
Gage length A [mm]	short		90 ¹⁾	90 ¹⁾	90 ¹⁾	90	90	90	90	90	90	90	90	100	100
Order No.	40.640...		.03.1	.04.1	.05.1	.06	.08	.10	.12	.14	.16	.18	.20	.25	.32
Gage length A [mm]	ZG130		—	—	—	130	130	130	130	130	130	130	130	130	—
Order No.	40.644...		—	—	—	.06	.08	.10	.12	.14	.16	.18	.20	.25	—
Gage length A [mm]	extralong		—	—	—	160	160	160	160	160	160	160	160	160	—
Order No.	40.642...		—	—	—	.06	.08	.10	.12	.14	.16	.18	.20	.25	—
Gage length A [mm]	ZG200		—	—	—	200	200	200	200	200	200	200	200	200	—
Order No.	40.646...		—	—	—	.06	.08	.10	.12	.14	.16	.18	.20	.25	—

Standard version, with Cool-Jet (Ø 3–5 mm Cooling with slits)

METRIC	Clamping Ø D1 [mm]		03	04	05	06	08	10	12	14	16	20	25
	Ø D2 [mm]		10	10	10	21	21	24	24	27	27	33	44
	Ø D3 [mm]		—	—	—	27	27	32	32	34	34	42	53
	L [mm]		9	12	15	36	36	42	47	47	50	52	58
Gage length A [mm]	short		90 ²⁾	90 ²⁾	90 ²⁾	90	90	90	90	90	90	90	100
Order No.	40.640...		.03	.04	.05	.06.2	.08.2	.10.2	.12.2	.14.2	.16.2	.20.2	.25.2

Standard version, with Safe-Lock™ pull out protection

METRIC	Clamping Ø D1 [mm]		06	08	10	12	14	16	18	20	25	32
	Ø D2 [mm]		21	21	24	24	27	27	33	33	44	44
	Ø D3 [mm]		27	27	32	32	34	34	42	42	53	53
	L [mm]		36	36	42	47	47	50	50	52	58	58
Gage length A [mm]	short		90 ³⁾	90 ³⁾	90 ³⁾	90 ³⁾	90 ³⁾	90 ³⁾	90 ³⁾	90 ³⁾	100 ³⁾	100 ³⁾
Order No.	40.640...		.06.7	.08.7	.10.7	.12.7	.14.7	.16.7	.18.7	.20.7	.25.7	.32.7

1) Without back-up screw, without thread for balancing screws, without slits along the clamping bore for cooling from outside

2) Without back-up screw, without thread for balancing screws, with slits along the clamping bore for cooling from outside

3) With tension spring

POWER SHRINK CHUCK BT40 · JIS B 6339



CERTIFICATE OF QUALITY

- Chuck body fine balanced
G2.5 25,000 rpm
or U < 1 gmm
- All functional surfaces machined
- Taper tolerance AT3
- Coolant supply form ADB
- Cool-Jet, can be sealed

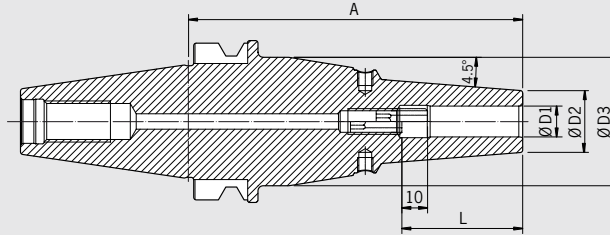

The Power Shrink Chuck is designed for the highest cutting performance in high-speed manufacturing. The optimized design combines high rigidity with vibration dampening, which protects the machine, spindle and tool.

- Highest cutting performance with higher spindle speeds, higher feeds and larger cutting depths
- Shorter cycle times
- Quieter running, therefore better surface quality and protection of tools, spindles and machines
- Higher machining accuracy
- With threaded holes for balancing screws
- Cool-Jet coolant bores that can be sealed included

The long versions (A=130 and 160) with slim tips are especially versatile to use.

- High rigidity
- Slim at the tip
- Dampen vibrations
- Higher clamping forces
- Equally suited to high-speed manufacturing and heavy milling
- Universal usage, saves space in tool magazine

Optional:

- Cooling with Cool Flash from 1/4"-1" for an extra charge (See pp. 182/183)
- Safe-Lock™ Pull out protection (See pages 184-187)

INCH	Clamping Ø D1 [inch]	1/4"	5/16"	3/8"	1/2"	5/8"	3/4"	1"	1 1/4"
	Ø D2 [inch]	0.87	0.87	1.04	1.04	1.16	1.39	1.79	1.79
	L [inch]	1.42	1.42	1.65	1.85	1.97	2.05	2.28	2.28
Gage length A [inch]	ultra short	2.76	2.76	2.76	2.76	2.95	2.95	3.35	3.35
Order No.	40.645...	.1/4z.3	.5/16z.3	.3/8z.3	.1/2z.3	.5/8z.3	.3/4z.3	.1z.3	.11/4z.3
Safe-Lock™ Order No.	40.645...	.1/4z.37	.5/16z.37	.3/8z.37	.1/2z.37	.5/8z.37	.3/4z.37	.1z.37	.11/4z.37



METRIC	Clamping Ø D1 [mm]	06	08	10	12	14	16	18	20	25	32
	Ø D2 [mm] ultra short	22	22	26.5	26.5	29.5	29.5	35.5	35.5	45.5	45.5
	L [mm] ultra short	36	36	42	47	47	50	50	52	58	58
Gage length A [mm]	ultra short	70	70	70	70	75	75	75	75	85	85
Order No.	40.645...	.06.3	.08.3	.10.3	.12.3	.14.3	.16.3	.18.3	.20.3	.25.3	.32.3
Safe-Lock™ Order No.	40.645...	.06.37	.08.37	.10.37	.12.37	.14.37	.16.37	.18.37	.20.37	.25.37	.32.37
	Ø D2 [mm] ZG130/oversize	21	21	24	24	27	27	33	33	—	—
	Ø D3 [mm] ZG130/oversize	50	50	50	50	50	50	50	50	—	—
	L [mm]	36	36	42	47	47	50	50	52	—	—
Gage length A [mm]	ZG130	130	130	130	130	130	130	130	130	—	—
Order No.	40.644...	.06.3	.08.3	.10.3	.12.3	.14.3	.16.3	.18.3	.20.3	—	—
Safe-Lock™ Order No.	40.644...	.06.37	.08.37	.10.37	.12.37	.14.37	.16.37	.18.37	.20.37	—	—
Gage length A [mm]	oversize	160	160	160	160	160	160	160	160	—	—
Order No.	40.642...	.06.3	.08.3	.10.3	.12.3	.14.3	.16.3	.18.3	.20.3	—	—
Safe-Lock™ Order No.	40.642...	.06.37	.08.37	.10.37	.12.37	.14.37	.16.37	.18.37	.20.37	—	—



Accessories

Cool Flash



Order No. 91.100.40

See pages 182/183

POWER MINI SHRINK CHUCK
BT40 · JIS B 6339

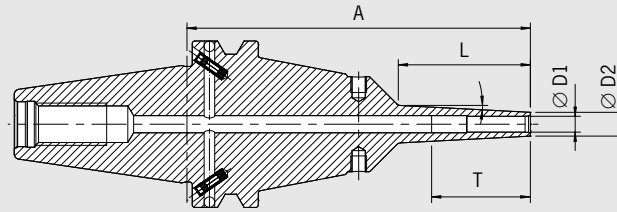

Drawing shows Standard version

CERTIFICATE OF QUALITY

- Chuck fine balanced
G2.5 25,000rpm
or U<1gmm
- All functional surfaces machined
- Taper tolerance AT3
- Coolant supply form ADB

Power Mini Shrink Chuck is perfect for 5-axis-machining in the die & mold and in the medical industry. Very slim at the top like the HAIMER Mini Shrink Chucks, the Power Mini Shrink is reinforced at the base. This allows for efficient milling with an angled tool even at long protruding lengths.

- 2 types: Standard (3 mm wall thickness) and extra slim (1.5 mm wall thickness)
- 3° slope at the top
- With threaded holes for balancing screws
- For solid carbide tools with shank tolerance h6
- **Attention: Shrinking only with shrink and cooling adapter**

JIS B 6339

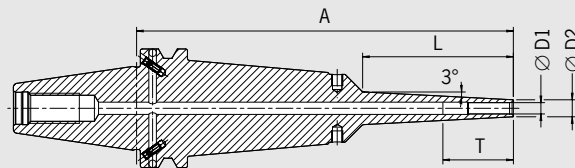

Drawing shows extra slim version

CERTIFICATE OF QUALITY

- Chuck body fine balanced
G2.5 25,000rpm
or U<1gmm
- All functional surfaces machined
- Taper tolerance AT3
- Coolant supply form ADB

BT40

METRIC	Clamping Ø D1 [mm]		03	04	05	06	08	10	12	16
	Ø D2 [mm] standard		09	10	11	12	14	16	18	24
	Ø D2 [mm] extra slim		06	07	08	09	11	13	15	—
	T [mm]		—	—	—	—	—	68	75	75
	L [mm] ZG130		50	50	50	50	50	50	50	50
Gage length A [mm]	ZG130		130	130	130	130	130	130	130	130
Order No.	standard	40.684...	.03.8	.04.8	.05.8	.06.8	.08.8	.10.8	.12.8	.16.8
Order No.	extra slim	40.674...	.03.8	.04.8	.05.8	.06.8	.08.8	.10.8	.12.8	—
	L [mm]		80	80	80	80	80	80	80	80
Gage length A [mm]	oversize		160	160	160	160	160	160	160	160
Order No.	standard	40.682...	.03.8	.04.8	.05.8	.06.8	.08.8	.10.8	.12.8	.16.8
Order No.	extra slim	40.672...	.03.8	.04.8	.05.8	.06.8	.08.8	.10.8	.12.8	—
Gage length A [mm]	ZG200		200	200	200	200	200	200	200	200
Order No.	standard	40.686...	.03.8	.04.8	.05.8	.06.8	.08.8	.10.8	.12.8	.16.8
Order No.	extra slim	40.676...	.03.8	.04.8	.05.8	.06.8	.08.8	.10.8	.12.8	—

POWER COLLET CHUCK
BT40 · JIS B 6339



CERTIFICATE OF QUALITY	
<input checked="" type="checkbox"/>	Chuck body fine balanced G2.5 25,000 rpm
<input checked="" type="checkbox"/>	All functional surfaces fine-machined
<input checked="" type="checkbox"/>	Taper tolerance AT3
<input checked="" type="checkbox"/>	Coolant supply form ADB

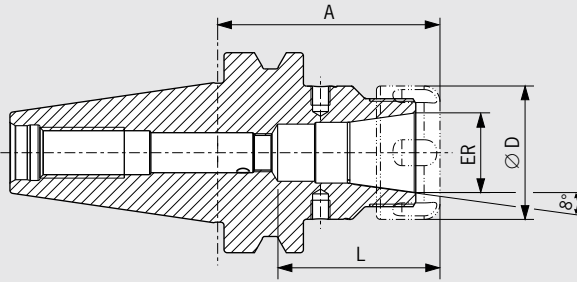

The Power Collet Chuck is designed for the highest machining capacity in high-speed manufacturing. The optimized design with improved construction combines high rigidity with vibration dampening features, giving more protection to the machine, spindle and tool. The universal Power Collet Chuck is a unique high performance chuck that can also be used with standard collets.

- High runout accuracy: < 0.00012" (3µm) at 3 × D with HAIMER Power Collets
- Also for standard collets ER according to ISO 15488 (formerly DIN 6499)
- High rigidity

- Runs smoother thanks to vibration absorbing geometry, yielding better surface finish and increased tool, spindle and machine protection
- Highest cutting performance with higher spindle speeds, higher feeds and larger cutting depths
- Shorter cycle times, higher machining accuracy, higher clamping forces
- Equally suited to high-speed manufacturing and heavy milling
- With threaded holes for balancing screws
- Optional: Cool-Jet bores on Power Collets from ER 25 Ø 1/4"
- Program of Power Collets on pages 154 – 157

INCH	ER	16	25	32
	Ø D [inch]	1.1	1.65	1.97
	Clamping range [inch]	1/8"-3/8"	1/8"-5/8"	1/8"-3/4"
	L [inch]	1.69	2.01	2.09
Gage length A [inch]	short	2.76	2.76	2.76 (L=2.52 inch)
Order No.	40.520...	.16.3	.25.3	.32.3
Gage length A [inch]	long	3.94	3.94	3.94
Order No.	40.521...	.16.3	.25.3	.32.3
Gage length A [inch]	oversize	6.30	6.30	6.30
Order No.	40.522...	.16.3	.25.3	.32.3

METRIC	ER	16	25	32
	Ø D [mm]	28	42	50
	Clamping range [mm]	2.0-10.0	2.0-16.0	2.0-20.0
	L [mm]	43	51	53
Gage length A [mm]	short	70	70	70 (L=64mm)
Order No.	40.520...	.16.3	.25.3	.32.3
Gage length A [mm]	long	100	100	100
Order No.	40.521...	.16.3	.25.3	.32.3
Gage length A [mm]	oversize	160	160	160
Order No.	40.522...	.16.3	.25.3	.32.3

Accessories

Locknut (fine-balanced)				
Size		ER 16	ER 25	ER 32
Order No. 83.914...		.16	.25	.32
Clamping wrench				See page 158
Torque Master torque wrench for Power Collet Chucks				See page 158
Order No. 84.600.00				
Power Collets				See page 154
Power Collets with Safe-Lock™				See page 156
Cool-Jet bores for Power Collets				See page 157
Order No. 91.100.27				

ER COLLET CHUCK
BT40 · JIS B 6339

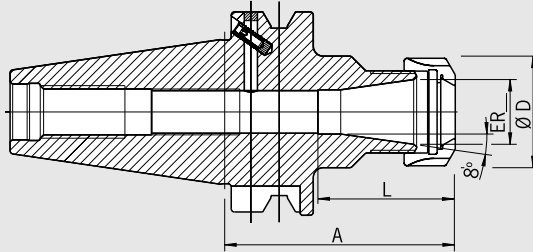

CERTIFICATE OF QUALITY

- Chuck body fine balanced
G2.5 25,000 rpm
- All functional surfaces machined
- Taper tolerance AT3
- Coolant supply form ADB



Use:

For clamping tools with cylindrical shank in ER collets according to ISO 15488.

- Included in delivery: Locknut (balanced, with slide coating for higher clamping forces)
- Locknut type HS (High-Speed, fine balanced, with slide coating for higher clamping forces) for an extra charge
- Increasing size L possible upon request

BT 40 FORM ADB

Form ADB means: central-coolant supply and coolant channels through the flange which can be sealed again

INCH	ER	ER16	ER20	ER25	ER32	ER40
	Ø D [inch]	1.1	1.34	1.65	1.97	2.48
	Clamping range [inch]	0.02-0.39	0.04-0.51	0.04-0.63	0.04-0.79	0.08-1.02
	Clamping range [mm]	0.5-10.5	1.5-13.0	1.0-16.0	1.5-20.0	2.5-26.0
L [inch]		¹⁾	1.63	2.24	2.52	2.83
Gage length A [inch]	short		2.76	2.76	2.76	2.76
Order No.	40.520...	.16	.20	.25	.32	.40
L [inch]		¹⁾	1.63	2.24	2.52	2.87
Gage length A [inch]	long		3.94	3.94	3.94	3.94
Order No.	40.521...	.16	.20	.25	.32	.40
L [inch]		¹⁾	1.63	2.24	2.52	2.87
Gage length A [inch]	oversize		6.30	6.30	6.30	6.30
Order No.	40.522...	.16	.20	.25	.32	.40

Accessories

Spare parts Collet nut, Pre-balanced

Ø ER	ER16	ER20	ER25	ER32	ER40
Order No. 83.912... 	.16	.20	.25	.32	.40

Collet nut HS (Highspeed), fine-balanced

Ø ER	ER16	ER20	ER25	ER32	ER40
Order No. 83.912... 	.16.HS	.20.HS	.25.HS	.32.HS	.40.HS

Spare parts Wrench

Ø ER	ER16	ER20	ER25	ER32	ER40
Order No. 84.200... 	.16	.20	-	-	-

Spare parts Wrench

Ø ER	ER16	ER20	ER25	ER32	ER40
Order No. 84.200... 	-	-	.25	.32	.40

Spare parts Balancing index rings

Ø ER long/oversize	ER16	ER20	ER25	ER32	ER40
Order No. 79.350... 	.28	.34	.42	.48	.52

Spare parts Collet

See accessories 					
---	--	--	--	--	--

Spare parts Pull Studs

See accessories 					
---	--	--	--	--	--

1) Drilled through

HG Collet Chuck



– No nuts: fantastic runout accuracy and a slim profile.

– Maintenance free alternative to Hydraulic chucks or press collet systems.

– No coolant accessories needed for coolant through cutting tools.

– “Cool-Jet” option available for coolant around the cutting tool.

–Excellent for high precision drilling, reaming or high speed machining.

JIS B 6339

HG COLLET CHUCK
BT 40 · JIS B 6339

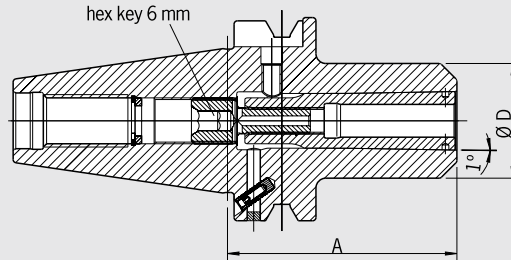

CERTIFICATE OF QUALITY	
<input checked="" type="checkbox"/>	Chuck body fine balanced G2.5 25,000rpm or U<1gmm
<input checked="" type="checkbox"/>	All functional surfaces machined
<input checked="" type="checkbox"/>	Taper tolerance AT3
<input checked="" type="checkbox"/>	Coolant supply form ADB

Use:

For highly precise clamping of tools with cylindrical shank with special collets. Also for shanks with clamping flats. Very useful for high-speed machining.

BT 40 FORM ADB

Form ADB means: central-coolant supply and coolant channels through the flange which can be sealed again

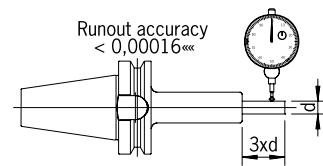

- Included in delivery: high-precision chuck with clamping screw and pull-out hook without collet
- Shank tolerance h6
- Extensions available for High-Precision Chuck
- Optional: Cool-Jet bores on HG Collets from Ø 1/4"

INCH	HG		01	02	03
	Ø D [inch]		1.18	1.38	1.89
	Clamping Ø shank tolerance h6 [inch]		0.08–0.35	0.39–0.57	0.63–0.79
Gage length A [inch]	short		2.56	2.76	2.95
Order No.	40.620...		.01	.02	.03
Gage length A [inch]	long		3.94	3.94	3.94
Order No.	40.621...		.01	.02	.03

Accessories

Spare parts Collet

See accessories

Spare parts Locking Screw

HG short			01	02	03
Order No.	82.560...		.03	.02	.02
HG ZG130			01	02	03
Order No.	82.560...		.04	.01	.05
HG oversize			01	02	03
Order No.	82.560...		.08	.06	.07

Pull-out hook

HG			HG 01	HG 02	HG 03
Order No.	82.570...		.00	.00	.00

Spare parts Balancing index rings

HG			01	02	03
Order No.	79.350...		.30	.35	.48

Spare parts Pull Studs

HG					
See accessories					

FACE MILL ARBOR
BT 40 · JIS B 6339

CERTIFICATE OF QUALITY

- Chuck body fine balanced
G2.5 22,000 rpm
or U<1gmm
- All functional surfaces machined
- Taper tolerance AT3
- Coolant supply form ADB

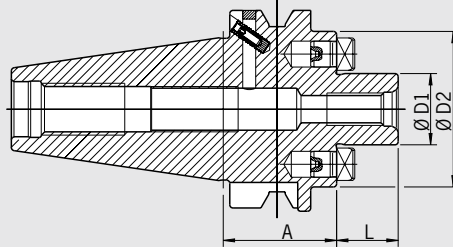

Use:

For holding face mill cutters and milling cutters with radial driving slot
DIN 1880 and exceeding Ø 40 clamping according to DIN 2079
(4 additional thread holes).

Metric sizes:

With coolant exit bores on the end face for milling cutters with central cooling

BT 40 FORM ADB

Form ADB means: central-coolant supply and coolant channels through the
flange which can be sealed again

- Included in delivery: complete with tightening bolt
- Coolant bores on front side for an extra charge (Inch sizes)

INCH	Clamping Ø D1 [inch]		3/4"	1"	1 1/4"
	Ø D2 [inch]		1.71	2.17	2.75
	L [inch]		0.67	0.67	0.67
Gage length A [inch]	short		1.38	1.97	2.36
Order No.	40.550...		.3/4Z	.1Z	.1 1/4Z

METRIC	Clamping Ø D1 [mm]		16	22	27	32	40
	Ø D2 [mm]		36	48	59	78	87
	L [mm]		17	19	21	24	27
Gage length A [mm]	short		35	35	35	65	70
Order No.	40.550...		.16.KKB	.22.KKB	.27.KKB	.32.KKB	.40.KKB
Gage length A [mm]	long		—	100	100	—	—
Order No.	40.551...		—	.22.KKB	.27.KKB	—	—

Accessories

See accessories (pg. 143)

Spare parts Clamping Screw

Ø D1 [inch]			3/4"	1"	1 1/4"
Order No.	85.300...		.3/4Z	.1Z	.11/4Z

Spare parts Wrench

Ø D1 [inch]			3/4"	1"	1 1/4"
Order No.	84.400...		.3/4Z	.1Z	.11/4Z

Spare parts Balancing index rings

Ø D1 [inch]			3/4"	1"	—
Order No.	79.350...		.1.71Z	.55	—

Spare parts Pull Studs



Spare parts Balancing index rings

Order No.	91.100.03				
-----------	-----------	--	--	--	--

Accessories

Spare parts Clamping Screw

Ø D1 [mm]			16	22	27	32	40
Order No.	85.300...		.16	.22	.27	.32	.40

Spare parts Wrench

Ø D1 [mm]			16	22	27	32	40
Order No.	84.400...		.16	.22	.27	.32	.40

Spare parts Balancing index ring

Ø D1 [mm]			16	22	27	32	40 ¹⁾
Order No.	79.350...		.40	.48	.48	.78	.87

Spare parts Pull Studs



ADAPTER FOR MORSE TAPER WITH THREAD
BT40 · JIS B 6339

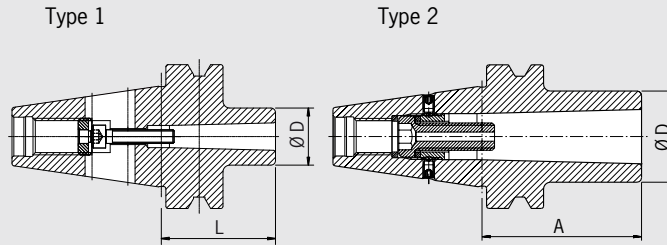

CERTIFICATE OF QUALITY	
<input checked="" type="checkbox"/>	Chuck body balanced G6.3 8,000 rpm
<input checked="" type="checkbox"/>	All functional surfaces fine machined
<input checked="" type="checkbox"/>	Taper tolerance AT3

Use:

For clamping tools with Morse taper and thread according to DIN 228-1 form A.

Similar to DIN 6383 with taper **JIS B 6339 BT40 form AD**.

- Included in delivery: tightening bolt
- Fine-balancing for an extra charge

MK3 and MK4 without bore for tang Form AD

Type		1	1	2	2
MK		01	02	03	04
Ø D [mm]		25	32	40	48
Gage Length A [mm]	short	50	50	70	95
Order No.	40.630...	.01	.02	.03	.04

Accessories

Balancing index rings

MK		01	02	03	04
Order No.	79.350...	.25	.32	.40	.48

Pull studs



ADAPTER FOR MORSE TAPER WITH TANG BT40 · JIS B 6339

CERTIFICATE OF QUALITY

- Chuck balanced
G6.3 8,000 rpm
- All functional surfaces fine machined
- Taper tolerance AT3

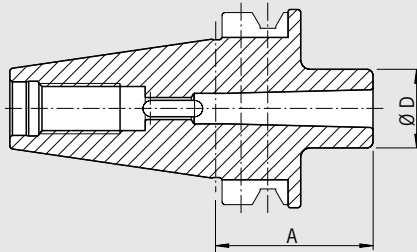

Use:

For holding tools with Morse tapers and tang according to DIN 228-11 form B.

Similar to DIN 6383 with taper **JIS B 6339 BT40 form AD**.

– Fine-balancing for an extra charge

MK		01	02	03	04
Ø D [mm]		25	32	40	48
Gage Length A [mm]	short	50	50	70	95
Order No.	40.580...	.01	.02	.03	.04

Accessories

Balancing index rings

MK		01	02	03	04
Order No.	79.350...	.25	.32	.40	.48

Pull studs



SHRINK FIT CHUCK
BT50 · JIS B 6339

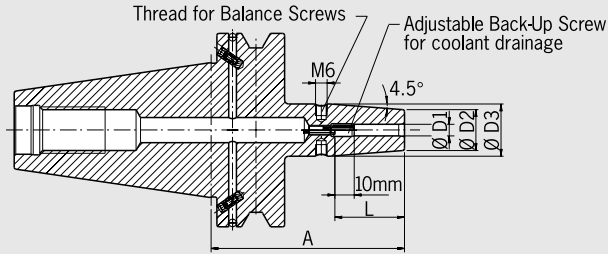

CERTIFICATE OF QUALITY	
<input checked="" type="checkbox"/>	Chuck body fine balanced G2.5 25,000 rpm or U<1gmm
<input checked="" type="checkbox"/>	All functional surfaces machined
<input checked="" type="checkbox"/>	Taper tolerance AT3
<input checked="" type="checkbox"/>	Coolant supply form ADB

Use:

Shrink fit chuck suitable for use with all available shrink fit units.

JIS B 6339 **BT 50 FORM ADB**

Form ADB means: central coolant supply and coolant channels through the flange which can be sealed again

- Heat resistant hot-working steel
- Hardened 54–2 HRC
- For HSS and solid carbide tools
- Shank tolerance h6
- Included in delivery: Shrink fit chuck with back-up screw
- With threaded holes for balancing screws

Optional:

- Cooling with Cool-Jet for an extra charge
- Cooling with Cool Flash from diam. 6 mm–25 mm for an extra charge (See pp. 182/183)

Standard version, similar to DIN 69882-8

METRIC	Clamping Ø D1 [mm]		06	08	10	12	14	16	18	20	25	32
	Ø D2 [mm]		21	21	24	24	27	27	33	33	44	44
	Ø D3 [mm]		27	27	32	32	34	34	42	42	53	53
	L [mm]		36	36	42	47	47	50	50	52	58	58
Gage length A [mm]	short		100	100	100	100	100	100	100	100	100	100
Order No.	50.640...		.06	.08	.10	.12	.14	.16	.18	.20	.25	.32
Gage length A [mm]	ZG130		130	130	130	130	130	130	130	130	130	130
Order No.	50.644...		.06	.08	.10	.12	.14	.16	.18	.20	.25	.32
Gage length A [mm]	oversize		160	160	160	160	160	160	160	160	160	160
Order No.	50.642...		.06	.08	.10	.12	.14	.16	.18	.20	.25	.32
Gage length A [mm]	ZG200		200	200	200	200	200	200	200	200	200	200
Order No.	50.646...		.06	.08	.10	.12	.14	.16	.18	.20	.25	.32

Accessories

See accessories (pg. 143)

Spare parts Pull Studs



Spare parts Reduction Sleeves for small shanks



Spare parts Balance Screws



Spare parts Back-up screws



Shrink fit extensions



Cool Flash Upgrade



Order No. 91.100.41

See pages 182/183

POWER SHRINK CHUCK JIS B 6339 · BT50



CERTIFICATE OF QUALITY

- Chuck body fine balanced
G2.5 25,000 rpm
or U < 1 gmm
- All functional surfaces machined
- Taper tolerance AT3
- Coolant supply form ADB
- Cool-Jet, can be sealed

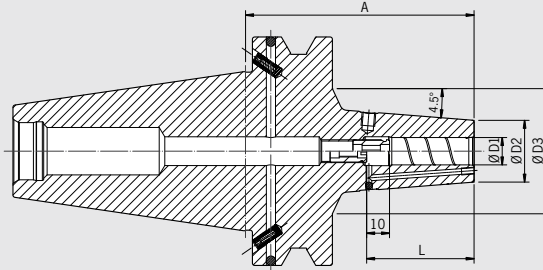

The Power Shrink Chuck is designed for the highest cutting performance in high-speed manufacturing. The optimized design combines high rigidity with vibration dampening, which protects the machine, spindle and tool.

- Highest cutting performance with higher spindle speeds, higher feeds and larger cutting depths
- Shorter cycle times
- Quieter running, therefore better surface quality and protection of tools, spindles and machines
- Higher machining accuracy
- With threaded holes for balancing screws
- Cool-Jet coolant bores that can be sealed included



The oversize and ZG200 versions (A=160 and 200) with slim tips are especially versatile to use.

- High rigidity
- Slim at the tip
- Dampen vibrations
- Higher clamping forces
- Equally suited to high-speed manufacturing and heavy milling
- Universal usage, saves space in tool magazine

Optional:

- Cooling with Cool Flash from ¼" - 1" for an extra charge (See pp. 182/183)
- Safe-Lock™ Pull out protection (See pages 184-187)

INCH	Clamping Ø D1 [inch]		1/4"	5/16"	3/8"	1/2"	5/8"	3/4"	1"
	Ø D2 [inch]		0.83	0.83	1.06	1.06	1.31	1.76	1.76
	Ø D3 [inch]		2.76	2.76	2.17	2.17	-	-	-
	L [inch]		1.42	1.42	1.65	1.85	1.97	2.05	2.28
Gage length A [inch]	short		3.94	3.94	3.94	3.94	3.94	3.94	3.94
Order No.	50.640...		.1/4z.3	.5/16z.3	.3/8z.3	.1/2z.3	.5/8z.3	.3/4z.3	.1z.3
Safe-Lock™ Order No.	50.640...		.1/4z.37	.5/16z.37	.3/8z.37	.1/2z.37	.5/8z.37	.3/4z.37	.1z.37

METRIC	Clamping Ø D1 [mm]		06	08	10	12	14	16	18	20	25
	Ø D2 [mm] short		21	21	27	27	33.3	33.3	44.7	44.7	44.7
	Ø D3 [mm] short		70	70	55	55	-	-	-	-	-
	L [mm]		36	36	42	47	47	50	50	52	58
Gage length A [mm]	short		100	100	100	100	100	100	100	100	100
Order No.	50.640...		.06.3	.08.3	.10.3	.12.3	.14.3	.16.3	.18.3	.20.3	.25.3
Safe-Lock™ Order No.	50.640...		.06.37	.08.37	.10.37	.12.37	.14.37	.16.37	.18.37	.20.37	.25.37
	Ø D2 [mm] oversize/ZG200		21	21	27	27	33	33	44	44	44
	Ø D3 [mm] oversize/ZG200		83	83	83	83	83	83	83	83	83
Gage length A [mm]	oversize		160	160	160	160	160	160	160	160	160
Order No.	50.642...		.06.3	.08.3	.10.3	.12.3	.14.3	.16.3	.18.3	.20.3	.25.3
Safe-Lock™ Order No.	50.642...		.06.37	.08.37	.10.37	.12.37	.14.37	.16.37	.18.37	.20.37	.25.37
Gage length A [mm]	ZG200		200	200	200	200	200	200	200	200	200
Order No.	50.646...		.06.3	.08.3	.10.3	.12.3	.14.3	.16.3	.18.3	.20.3	.25.3
Safe-Lock™ Order No.	50.646...		.06.37	.08.37	.10.37	.12.37	.14.37	.16.37	.18.37	.20.37	.25.37

Accessories

Cool Flash



Order No. 91.100.40

See pages 182/183

HEAVY DUTY CHUCK
JIS B 6339 · BT50

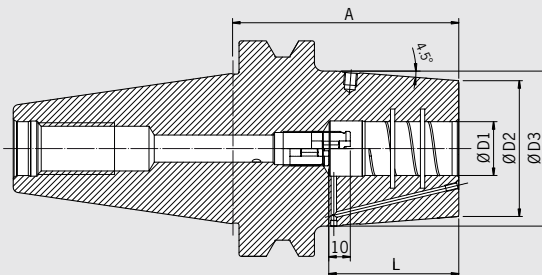

CERTIFICATE OF QUALITY	
<input checked="" type="checkbox"/>	Chuck body fine balanced G2.5 25,000 rpm or U<1 gmm
<input checked="" type="checkbox"/>	All functional surfaces machined
<input checked="" type="checkbox"/>	Taper tolerance AT3
<input checked="" type="checkbox"/>	Coolant supply form ADB
<input checked="" type="checkbox"/>	CoolJet, can be sealed

Finally there is a holder for heavy machining that can replace the Weldon tool holder. The Heavy Duty Chuck is a shrink fit chuck designed for extreme cases. The contour is optimized for highest rigidity and clamping force.



- Smooth clamping of the tool shank
- TIR less than 0.00012" (3 µm)
- Reinforced outer contour

- To shrink with 13kW HD-Coil or with high performance shrink fit unit HAIMER Power Clamp Profi Plus (20kW)
- With internal groove in the clamping bore
- With threaded holes for balancing screws
- Cool-Jet coolant bores that can be sealed included

Optional:

- Cooling with Cool Flash from 5/8" – 1" for an extra charge (See pp. 182/183)
- Safe-Lock™ Pull out protection (See pages 184–187)

INCH	Clamping Ø D1 [inch]		5/8"	3/4"	1"	1 1/4"	1 1/2"	2"
	Ø D2 [inch]		2.01	2.28	2.48	2.76	3.24	3.24
	Ø D3 [inch]		—	2.63	2.83	3.07	—	—
	L [inch]		1.97	2.05	2.28	2.40	3.46	3.46
Gage length A [inch]	short		3.94	3.94	4.13	4.13	4.53	4.72
Order No.	50.650...		.5/8z.6	.3/4z.6	.1z.6	.11/4z.6	.11/2z.6	.2z.6
Safe-Lock™ Order No.	50.650...		.5/8z.67	.3/4z.67	.1z.67	.11/4z.67	.11/2z.67	.2z.67

METRIC	Clamping Ø D1 [mm]		16	20	25	32	40	50
	Ø D2 [mm]		51	58	63	70	82	82
	Ø D3 [mm] short		—	67	72	78	—	—
	L [mm]		50	52	58	61	88	88
Gage length A [mm]	short		100	100	105	105	115 ¹⁾	120
Order No.	50.650...		.16.6	.20.6	.25.6	.32.6	.40.6	.50.6
Safe-Lock™ Order No.	50.650...		.16.67	.20.67	.25.67	.32.67	.40.67	.50.67
	Ø D3 [mm] oversize/ZG200		85	85	85	85	94	94
Gage length A [mm]	oversize		160	160	160	160	160	160
Order No.	50.652...		.16.6	.20.6	.25.6	.32.6	.40.6	.50.6
Safe-Lock™ Order No.	50.652...		.16.67	.20.67	.25.67	.32.67	.40.67	.50.67
Gage length A [mm]	ZG200		200	200	200	200	200	200
Order No.	50.656...		.16.6	.20.6	.25.6	.32.6	.40.6	.50.6
Safe-Lock™ Order No.	50.656...		.16.67	.20.67	.25.67	.32.67	.40.67	.50.67

Heavy Duty Chuck – For 13 kW shrink fit machine

Clamping	Ø D1 [mm]		16
	Ø D2 [mm]		46
	L [mm]		50
Gage length A [mm]	short		100
Order No.	50.640...		.16.6
Safe-Lock™ Order No.	50.640...		.16.67

Accessories

Cool Flash



Order No. 91.100.40

See pages 182/183

POWER COLLET CHUCK
JIS B 6339 · BT50



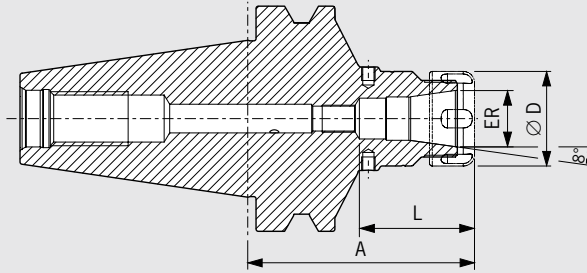

CERTIFICATE OF QUALITY	
<input checked="" type="checkbox"/>	Chuck body fine balanced G2.5 25,000 rpm
<input checked="" type="checkbox"/>	All functional surfaces fine-machined
<input checked="" type="checkbox"/>	Taper tolerance AT3
<input checked="" type="checkbox"/>	Coolant supply form ADB



The Power Collet Chuck is designed for the highest machining capacity in high-speed manufacturing. The optimized design with improved construction combines high rigidity with vibration dampening features, giving more protection to the machine, spindle and tool. The universal Power Collet Chuck is a unique high performance chuck that can also be used with standard collets.

- High runout accuracy: < 0.00012" (3µm) at 3×D with HAIMER Power Collets
- Also for standard collets ER according to ISO 15488 (formerly DIN 6499)
(Attention: By using standard collet ER length A will increase)

- High rigidity
- Runs smoother thanks to vibration absorbing geometry, yielding better surface finish and increased tool, spindle and machine protection
- Highest cutting performance with higher spindle speeds, higher feeds and larger cutting depths
- Shorter cycle times, higher machining accuracy, higher clamping forces
- Equally suited to high-speed manufacturing and heavy milling
- With threaded holes for balancing screws
- Optional: Cool-Jet bores on Power Collets from ER 25 Ø 1/4"
- Program of Power Collets on pages 154 – 157

INCH	ER		16	25	32
	Ø D [inch]		1.1	1.65	1.97
	Clamping range [inch]		1/8"-3/8"	1/8"-5/8"	1/8"-3/4"
	L [inch]		1.69	2.01	2.09
Gage length A [inch]	short		3.94	3.94	3.94
Order No.	50.520...		.16.3	.25.3	.32.3
Gage length A [inch]	ZG130		5.12	5.12	5.12
Order No.	50.524...		.16.3	.25.3	.32.3
Gage length A [inch]	oversize		6.30	6.30	6.30
Order No.	50.522...		.16.3	.25.3	.32.3

Accessories

Locknut (fine-balanced)

Size		ER 16	ER 25	ER 32	
Order No. 83.914...		.16	.25	.32	
Clamping wrench					See page 158

Torque Master torque wrench for Power Collet Chucks  See page 158
 Order No. 84.600.00

Power Collets See page 154

Power Collets with Safe-Lock™ See page 156

Cool-Jet bores for Power Collets  See page 157
 Order No. 91.100.27

ER COLLET CHUCK
BT 50 · JIS B 6339

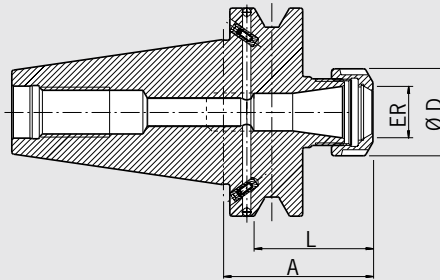

CERTIFICATE OF QUALITY	
<input checked="" type="checkbox"/>	Chuck body fine balanced G2.5 25,000 rpm or U<1 gmm
<input checked="" type="checkbox"/>	All functional surfaces fine machined
<input checked="" type="checkbox"/>	Taper tolerance AT3
<input checked="" type="checkbox"/>	Coolant supply form ADB

Use:

For clamping tools with cylindrical shank in ER collets

BT 50 FORM ADB

Form ADB means: central-coolant supply and coolant channels through the flange which can be sealed again

- Included in delivery: ER collet chuck with pre-balanced collet nut
- Balanced Collet nuts with special slide coating for low friction and higher clamping forces

INCH	ER	ER16	ER20	ER25	ER32	ER40
	Ø D [inch]	1.1	1.33	1.65	1.97	2.48
	Clamping range [inch]	0.02-0.39	0.05-0.51	0.04-0.63	0.04-0.79	0.08-1.02
	L [inch]	¹⁾	1.63	2.24	2.52	2.87
Gage length A [inch]	short	2.76	2.76	2.76	2.76	3.15
Order No.	50.520...	.16	.20	.25	.32	.40
Gage length A [inch]	long	3.94	3.94	3.94	3.94	3.94
Order No.	50.521...	.16	.20	.25	.32	.40
Gage length A [inch]	oversize	6.30	-	6.30	6.30	6.30
Order No.	50.522...	.16	-	.25	.32	.40

Accessories

See accessories (pg. 143)

Spare parts Collet nut, Pre-balanced

Ø ER	ER16	ER25	ER32	ER40
Order No. 83.912...	.16	.25	.32	.40

Collet nut HS (Highspeed), fine-balanced

Ø ER	ER16	ER25	ER32	ER40
Order No. 83.912...	.16.HS	.25.HS	.32.HS	.40.HS

Spare parts Wrench

Ø ER	ER16	ER25	ER32	ER40
Order No. 84.200...	.16	-	-	-

Spare parts Wrench

Ø ER	ER25	ER32	ER40
Order No. 84.200...	.25	.32	.40

Spare parts Balancing index rings

Ø ER long/oversize	ER16	ER25	ER32	ER40
Order No. 79.350...	.28	.42	.48	.52

Spare parts Collet

See accessories

Spare parts Pull Stud

See accessories

1) Drilled through

HG COLLET CHUCK
BT 50 · JIS B 6339

CERTIFICATE OF QUALITY	
<input checked="" type="checkbox"/>	Chuck body fine balanced G2.5 25,000 rpm or U<1 gmm
<input checked="" type="checkbox"/>	All functional surfaces fine machined
<input checked="" type="checkbox"/>	Taper tolerance AT3
<input checked="" type="checkbox"/>	Coolant supply form ADB

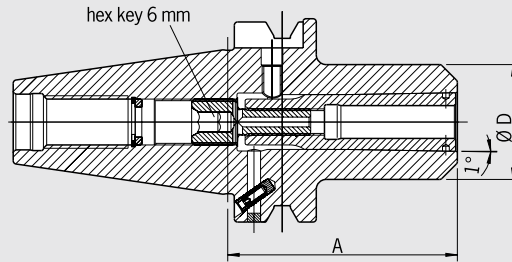

Use:

For highly precise clamping of tools with cylindrical shank with special collets. Also for shanks with clamping flats. Very useful for high-speed machining.

BT 50 FORM ADB

Form ADB means: central-coolant supply and coolant channels through the flange which can be sealed again

– Included in delivery: high-precision chuck with clamping screw and pull-out hook without collet

- Shank tolerance h6
- Extensions available for High-Precision Chuck
- Optional: Cool-Jet bores on HG Collets from Ø 1/4"

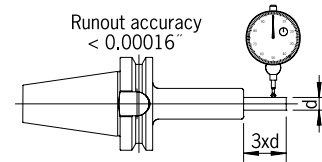

INCH	HG	01	02
	Ø D [inch]	1.18	1.38
	Clamping Ø shank tolerance h6 [inch]	0.08–0.35	0.39–0.57
Gage length A [inch]	long	–	3.94
Order No.	50.621...	–	.02
Gage length A [inch]	oversize	6.30	6.30
Order No.	50.622...	.01	.02

Accessories

See accessories (pg. 143)

Spare parts Collet

See accessories 

Spare parts Clamping Screw

HG long		01	02
Order No.	82.560...	.04	.01
HG oversize		01	02
Order No.	82.560...	.08	.06

Pull-out hook

HG		HG 01	HG 02
Order No.	82.570...	.00	.00

Spare parts Balancing index rings

HG		01	02
Order No.	79.350...	.30	.35

Spare parts Pull Studs

See accessories 

FACE MILL ARBOR
BT 50 · JIS B 6339

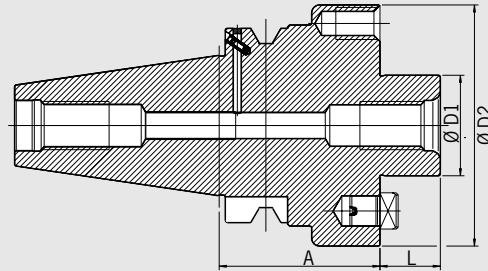

CERTIFICATE OF QUALITY	
<input checked="" type="checkbox"/>	Chuck body fine balanced G2.5 22,000 rpm or U<1gmm
<input checked="" type="checkbox"/>	All functional surfaces machined
<input checked="" type="checkbox"/>	Taper tolerance AT3
<input checked="" type="checkbox"/>	Coolant supply form ADB

Use:

For holding face mill cutters and milling cutters with radial driving slot
DIN 1880 and exceeding Ø 40 clamping according to DIN 2079 (4 additional
thread holes).
With coolant exit bores on the end face for milling cutters with central cooling.

Similar to DIN 6357 with taper **JIS B 6339 BT50 form ADB**.

Form ADB means: central-coolant supply and coolant channels through the
flange which can be sealed again.

– Included in delivery: complete with tightening bolt

METRIC	Clamping Ø D1 [mm]		22	27	32	40
	Ø D2 [mm]		48	60	78	89
	L [mm]		19	21	24	27
Gage length A [mm]	short		55	55	55	55
Order No.	50.550...		.22.KKB	.27.KKB	.32.KKB	.40.KKB
Gage length A [mm]	long		100	100	100	—
Order No.	50.551...		.22.KKB	.27.KKB	.32.KKB	—

Accessories

Spare parts Clamping Screw

Ø D1 [mm]		22	27	32	40	
Order No.	85.300...		.22	.27	.32	.40

Spare parts Wrench

Ø D1 [mm]		22	27	32	40	
Order No.	84.400...		.22	.27	.32	.40

Spare parts Balancing index ring

Ø D1 [mm]		22 ¹⁾	27 ²⁾	32	40	
Order No.	79.350...		.48	.48	.78	.87

Spare parts Pull Studs



Coolant bores

Order No.	91.100.03	
-----------	-----------	--

1) Not for 50.550.22 2) Not for 50.550.27

ADAPTER FOR MORSE TAPER WITH THREAD BT 50 · JIS B 6339

CERTIFICATE OF QUALITY

- Chuck body balanced
G6.3 8.000 rpm
- All functional surfaces fine machined
- Taper tolerance AT3

Type 1

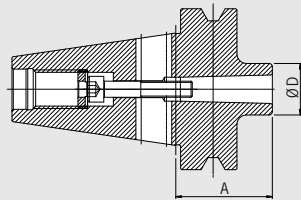

Type 2

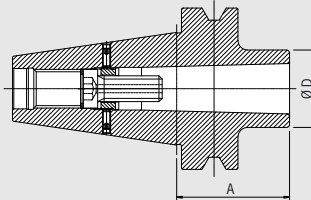

Use:

For clamping tools with Morse taper with drawbar thread according to DIN 228-1 form A.

Similar to DIN 6383 with taper **JIS B 6339 BT50 form A**.

- Included in delivery: tightening bolt
- Fine-balancing for an extra charge

MK3 and MK4 without bore for tang form AD

Type		1	1	2
MK		02	03	04
Ø D [mm]		32	40	48
Gage length A [mm]	short	60	65	70
Order No.	50.630...	.02	.03	.04



Accessories

Balancing index rings

MK		02	03	04
Order No.	79.350...	.32	.40	.48

Pull studs



ADAPTER FOR MORSE TAPER WITH TANG
BT 50 · JIS B 6339

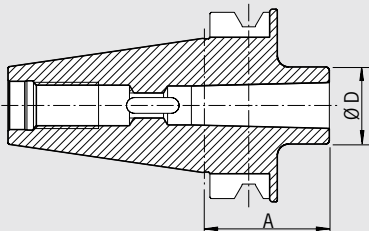

CERTIFICATE OF QUALITY	
<input checked="" type="checkbox"/>	Chuck balanced G6.3 8.000 rpm
<input checked="" type="checkbox"/>	All functional surfaces fine machined
<input checked="" type="checkbox"/>	Taper tolerance AT3

Use:

For holding tools with Morse tapers and tang according to DIN 228-11 form B.



Similar to DIN 6383 with taper **JIS B 6339 BT50 Form AD**.

– Fine-balancing for an extra charge

MK		02	03	04
	Ø D [mm]	32	40	48
	Gage Length A [mm]	60	65	95
	Order No.	50.580...	.02	.03
			.03	.04

Accessories

Balancing index rings

MK		02	03	04
Order No.	79.350...	.32	.40	.48
				
Pull studs				

BLANK ADAPTER BT 50 · JIS B 6339

CERTIFICATE OF QUALITY

- All functional surfaces fine machined
- Taper tolerance AT3

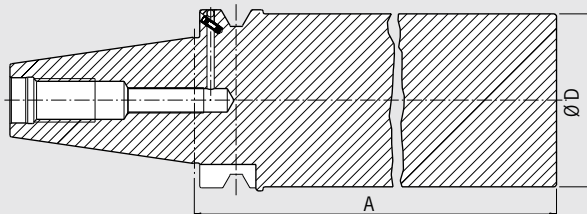

Use:

For manufacturing special tools in your factory.

Design:

Taper and groove are hardened and ground, the cylindrical part is soft.

With taper **JIS B 6339 BT50 Form ADB**.

Form ADB means: central coolant supply and coolant channels on the collar which can be sealed again.

Ø D [mm]		95.5
Gage Length A [mm]		315
Order No.	50.590...	.95

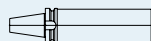

Accessories

Pull studs



Tight tolerances and high quality demands leave no room for compromises. Where quality is concerned, we trust ourselves first and foremost. Not only do we manufacture all our products in-house, the fixtures and vices on our machines are also made by HAIMER. We do so because we know that only **Quality wins**.



HAIMER.

Certificate of Quality

100% Made in Germany	<ul style="list-style-type: none"> ■ Consistent high quality due to 100% control in own factory ✓ ■ Highest process reliability during machining ✓
Tool holders fine balanced (G2.5 at 25,000 RPM)	<ul style="list-style-type: none"> ■ Low vibration on spindle ✓ ■ Better surfaces ✓ ■ Maximum tool life ■ Long lifetime of spindle
Steep taper is truly AT3: (1.5 µm shape tolerance)	<ul style="list-style-type: none"> ■ Optimum connection between machine and tool ✓ ■ Highest process reliability during fine machining ✓ ■ Secure clamping during heavy milling
High precision pullstuds made of special steel with high toughness	<ul style="list-style-type: none"> ■ No danger of breakage ✓ ■ Highest security against accidents ✓ ■ Precise tool clamping
All functional surfaces machined	<ul style="list-style-type: none"> ■ Symmetric force transmission to clamping shoulder of HSK ✓ ■ Precise drive slots on the HSK ✓ ■ More accurate than DIN

HSK



HSK-A 32/40/50		Face Mill Arbor	107
DIN 69893-1		Adapter for morse taper	108
Shrink Fit Chuck HSK-A32	68	Blank Adapter	110
Shrink Fit Chuck HSK-A40	69		
Shrink Fit Chuck HSK-A50	70	HSK-A 125/DIN 69893-1	
Power Collet Chuck	71	Power Shrink Chuck	111
ER Collet Chuck HSK-A32/40	72	Heavy Duty Chuck	112
ER Collet Chuck HSK-A50	73	Power Collet Chuck	113
Face Mill Arbor HSK-A40	74	Face Mill Arbor	114
Face Mill Arbor HSK-A50	75		
		HSK-E 25	
HSK-A 63/DIN 69893-1		DIN 69893-5	
Shrink Fit Chuck	76	Mini Shrink Fit Chuck	115
Power Shrink Chuck	78	Collet Chuck Mini ER	116
Heavy Duty Chuck	79	Power Collet Chuck	117
Mini Shrink Chuck	80		
Power Mini Shrink Chuck	81	HSK-E 32/40/50	
Power Collet Chuck	82	DIN 69893-5	
ER Collet Chuck	83	Shrink Fit Chuck HSK-E32	118
HG Collet Chuck	84	Shrink Fit Chuck HSK-E40	119
Face Mill Arbor	85	Shrink Fit Chuck HSK-E50	120
Adapter for morse taper	86	Mini Shrink Chuck HSK-E32/40/50	121
Blank Adapter	88	Mini Shrink Shrink and Cooling Sleeves	123
		Power Collet Chuck E32/40/50	124
HSK-A 63/80 DIN 69893-1		ER Collet Chuck HSK-E32/40	125
Shrink Fit Chuck	89	ER Collet Chuck HSK-E50	126
Power Shrink Chuck	90	Face Mill Arbor HSK-E50	127
Power Mini Shrink Chuck	94		
Power Collet Chuck	95	HSK-F 63/DIN 69893-6	
Face Mill Arbor	96	Shrink Fit Chuck	128
		ER Collet Chuck	129
HSK-A 80/DIN 69893-1		Face Mill Arbor	130
Shrink Fit Chuck	97		
Power Shrink Chuck	98	HSK-F 80/Makino	
ER Collet Chuck	99	Shrink Fit Chuck	131
Power Collet Chuck	100	ER Collet Chuck	133
		Face Mill Arbor	134
HSK-A 100/DIN 69893-1			
Shrink Fit Chuck	101		
Power Shrink Chuck	102		
Heavy Duty Chuck	103		
Power Collet Chuck	104		
ER Collet Chuck	105		
HG Collet Chuck	106		

SHRINK FIT CHUCK
HSK-A 32 · DIN 69893-1

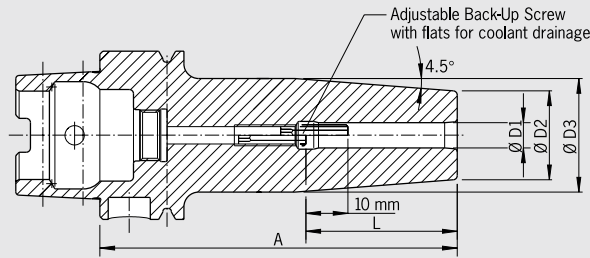

CERTIFICATE OF QUALITY

- Chuck body fine balanced
G2.5 25,000rpm
or U<1gmm
- All functional surfaces machined
- More accurate than DIN

Use:

Shrink fit chuck suitable for use with all available shrink fit units.

DIN 69893-1

- Included in delivery: Shrink fit chuck with backup screw, without coolant tube
- Heat resistant hot-working steel
- Hardened 54-2 HRC
- For HSS and solid carbide tools
- Shank tolerance h6

Optional:

- Cooling with Cool-Jet for an extra charge (See page 180)
- Cooling with Cool Flash from diam. 6 mm for an extra charge (See pp. 182/183)

Standard version, similar to DIN 69882-8

METRIC	Clamping Ø D1 [mm]	03	04	05	06	08	10
	Ø D2 [mm]	10	10	10	21	21	24
	Ø D3 [mm]	—	—	—	27	27	32
	L [mm]	09	12	15	36	36	42
Form A 32							
Gage length A [mm]	short	60 ¹⁾	60 ¹⁾	60 ¹⁾	70 ²⁾	70 ²⁾	80 ²⁾
Order No.	A32.140...	.03	.04	.05	.06	.08	.10

Accessories

See accessories (pg. 143)

Spare parts Coolant Tube

Order No. 85.700...  .32

Spare parts Back up Screws



Cool Flash Upgrade



Order No. 91.100.41

See pages 182/183

1) Without back-up screw, with slits along the clamping bore for coolant around the tool
2) Without threads for balancing screws

SHRINK FIT CHUCK HSK-A 40 · DIN 69893-1

CERTIFICATE OF QUALITY

- ☑ Chuck body fine balanced
G2.5 25,000rpm
or U<1gmm
- ☑ All functional surfaces machined
- ☑ More accurate than DIN

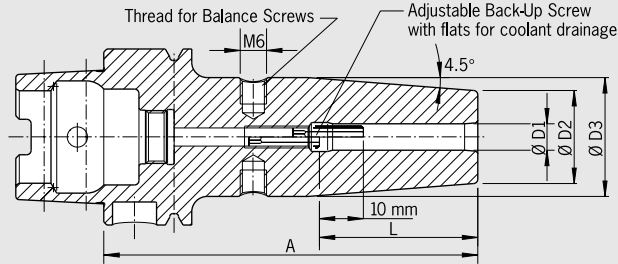

Use:

Shrink fit chuck suitable for use with all available shrink fit units.

Optional:

- Cooling with Cool-Jet for an extra charge (See page 180)
- Cooling with Cool Flash from 1/4" for an extra charge (See pp. 182/183)

DIN 69893-1

- Included in delivery: Shrink fit chuck with backup screw, without coolant tube
- Heat resistant hot-working steel
- Hardened 54-2 HRC
- For HSS and solid carbide tools
- Shank tolerance h6
- With threaded holes for balancing screws

INCH	Clamping Ø D1 [inch]		1/8"	3/16"	1/4"	3/8"	1/2"	5/8"
	Ø D2 [inch]		0.39	0.39	0.83	0.94	0.94	1.06
	Ø D3 [inch]		—	—	1.06	1.26	1.26	1.30
	L [inch]		0.35	0.59	1.42	1.65	1.85	1.97
Form A 40								
Gage length A [inch]	short		2.36 ¹⁾	2.36 ¹⁾	3.15	3.15	3.54	3.54
Order No.	A40.140...		.1/8Z	.3/16Z	.1/4Z	.3/8Z	.1/2Z	.5/8Z

Standard version, similar to DIN 69882-8

METRIC	Clamping Ø D1 [mm]		03	04	05	06	08	10	12	14	16
	Ø D2 [mm]		10	10	10	21	21	24	24	27	27
	Ø D3 [mm]		—	—	—	27	27	32	32	34	34
	L [mm]		09	12	15	36	36	42	47	47	50
Form A 40											
Gage length A [mm]	short		60 ¹⁾	60 ¹⁾	60 ¹⁾	80	80	80	90	90	90
Order No.	A40.140...		.03	.04	.05	.06	.08	.10	.12	.14	.16
Gage length A [mm]	ZG130		—	—	—	130	130	130	130	—	—
Order No.	A40.144...					.06	.08	.10	.12		

Accessories

See accessories (pg. 143)

Spare parts Coolant Tube

Order No. 85.700... .40

Spare parts Set of Balance Screws



Spare parts Back up Screws



Cool Flash Upgrade



Order No. 91.100.41

See pages 182/183

1) Without back-up screw, without threaded holes for balancing screws, with slits along the clamping bore for coolant around the tool

SHRINK FIT CHUCK
HSK-A 50 · DIN 69893-1

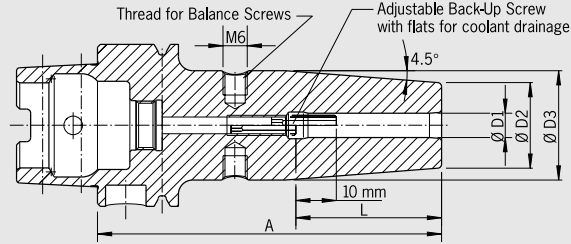

CERTIFICATE OF QUALITY

- Chuck body fine balanced G2.5 25,000 rpm or U<1gmm
- All functional surfaces machined
- More accurate than DIN

Use:

Shrink fit chuck suitable for use with all available shrink fit units.

- For HSS and solid carbide tools
- Shank tolerance h6
- With threaded holes for balancing screws

DIN 69893-1

- Included in delivery: Shrink fit chuck with backup screw, without coolant tube
- Heat resistant hot-working steel
- Hardened 54-2 HRC

- Optional:
- Cooling with Cool-Jet for an extra charge (See page 180)
 - Cooling with Cool Flash from diam. 6 mm for an extra charge (See pp. 182/183)

Standard version, similar to DIN 69882-8

METRIC	Clamping Ø D1 [mm]	03	04	05	06	08	10	12	14	16
	Ø D2 [mm]	10	10	10	21	21	24	24	27	27
	Ø D3 [mm]				27	27	32	32	34	34
	L [mm]	09	12	15	36	36	42	47	47	50
Form A 50										
Gage length A [mm]	short	60 ¹⁾	60 ¹⁾	60 ¹⁾	80	80	85	90	90	95
Order No.	A50.140...	.03	.04	.05	.06	.08	.10	.12	.14	.16
Gage length A [mm]	ZG130	-	-	-	130	130	130	130	-	130
Order No.	A50.144...	-	-	-	.06	.08	.10	.12	-	.16

Accessories

See accessories (pg. 143)

Spare parts Coolant Tube

Order No. 85.700...  .50

Spare parts Set of Balance Screws

See accessories 

Spare parts Back up Screws

See accessories 

Cool Flash Upgrade  Order No. 91.100.41 See pages 182/183

1) Without back-up screw, without threads for balancing screws, with slits along the clamping bore for coolant around the tool

POWER COLLET CHUCK
HSK-A 32/40/50 · DIN 69893-1



CERTIFICATE OF QUALITY	
<input checked="" type="checkbox"/>	Chuck body fine balanced G2.5 25,000 rpm
<input checked="" type="checkbox"/>	All functional surfaces fine machined
<input checked="" type="checkbox"/>	More accurate than DIN

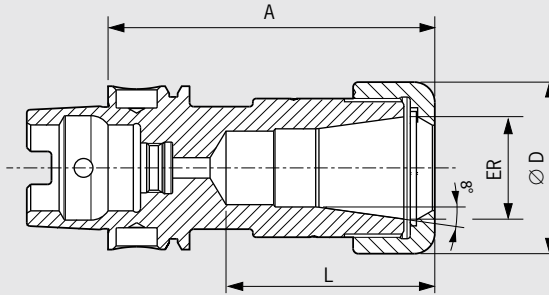

The Power Collet Chuck is designed for the highest machining capacity in high-speed manufacturing. The optimized design with improved construction combines high rigidity with vibration dampening features, giving more protection to the machine, spindle and tool. The universal Power Collet Chuck is a unique high performance chuck that can also be used with standard collets.

- High runout accuracy: < 0.00012" (3µm) at 3×D with HAIMER Power Collets
- Also for standard collets ER according to ISO 15488 (formerly DIN 6499) (Attention: By using standard collet ER length A will increase)

- High rigidity
- Runs smoother thanks to vibration absorbing geometry, yielding better surface finish and increased tool, spindle and machine protection
- Highest cutting performance with higher spindle speeds, higher feeds and larger cutting depths
- Shorter cycle times, higher machining accuracy, higher clamping forces
- Equally suited to high-speed manufacturing and heavy milling
- With threaded holes for balancing screws
- Optional: Cool-Jet bores on Power Collets from ER 25 Ø 1/4"
- Program of Power Collets on pages 154 – 157

INCH	ER	16	25	32
	Ø D [inch]	1.1	1.65	1.97
	Clamping range [inch]	1/8"-3/8"	1/8"-5/8"	1/8"-3/4"
Form A32				
	L [inch]	1.26	1.53	
Gage length A [inch]	ultra short	1.97	2.36	
Order No.	A32.025...	.16.3	.25.3	
Form A40				
	L [inch]	1.22	1.51	1.85
Gage length A [inch]	ultra short	1.97	2.36	2.76
Order No.	A40.025...	.16.3	.25.3	.32.3
	L [inch]	1.69	2.01	2.09
Gage length A [inch]	short	3.15	3.15	3.15
Order No.	A40.020...	.16.3	.25.3	.32.3
Form A50				
	L [inch]	1.26	1.53	1.89
Gage length A [inch]	ultra short	2.36	2.56	2.95
Order No.	A50.025...	.16.3	.25.3	.32.3

Accessories

Locknut (fine-balanced)				
Size		ER 16	ER 25	ER 32
Order No. 83.914...		.16	.25	.32
Clamping wrench				See page 158
Torque Master torque wrench for Power Collet Chucks				See page 158
Order No. 84.600.00				
Power Collets				See page 154
Power Collets with Safe-Lock™				See page 156
Cool-Jet bores for Power Collets				See page 157
Order No. 91.100.27				

ER COLLET CHUCK
HSK-A 32/40 · DIN 69893-1

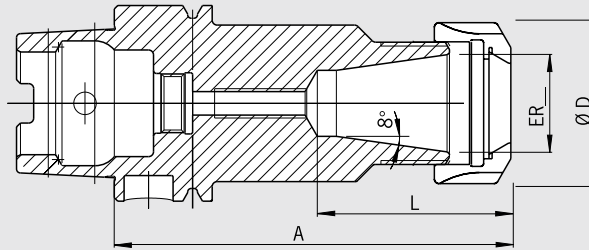

CERTIFICATE OF QUALITY

- Chuck body fine balanced
G2.5 25,000rpm
or U<1gmm
- All functional surfaces machined
- More accurate than DIN

Use:

For clamping tools with cylindrical shank in ER collets according to ISO 15488.

- Locknut type HS (High-Speed, fine balanced, with slide coating for higher clamping forces)
- Increasing size L possible upon request

INCH	ER	ER11	ER16	ER25	ER32
	ØD [inch]	0.75	1.1	1.65	1.97
	Clamping range [inch]	0.02–0.28	0.02–0.39	0.04–0.63	0.04–0.79
	Clamping range [mm]	0.5–7.0	0.5–10.0	1.0–16.0	1.5–20.0
Form A32					
L [inch]			1.30		
Gage length A [inch]	ultra short		2.17 ¹⁾		
Order No.	A32.025...	—	.16	—	—
L [inch]			1.30	1.61	
Gage length A [inch]	short		3.15	3.15	
Order No.	A32.020...	—	.16	.25	—
Form A40					
L [inch]		1.05	1.30	1.61	1.85
Gage length A [inch]	ultra short	2.36 ¹⁾	2.36 ¹⁾	2.76 ¹⁾	2.76 ¹⁾
Order No.	A40.025...	.11	.16	.25	.32
L [inch]			1.28	1.61	
Gage length A [inch]	short		3.15	3.15	
Order No.	A40.020...	—	.16	.25	—

Accessories

See accessories (pg. 143)

Spare parts Collet nut HS (Highspeed), fine-balanced

Ø ER		ER16	ER25	ER32
Order No.	83.912...	.16.HS	.25.HS	.32.HS

Spare parts Wrench

Ø ER		ER11	ER16	
Order No.	84.200...	.11	.16	

Spare parts Wrench

Ø ER			ER25	ER32
Order No.	84.200...		.25	...32

Spare parts Balancing index rings

Ø ER		ER16	ER25	ER32
Order No.	79.350...	.28	.42	.48

Spare parts Collet

Ø ER				
See accessories				

Spare parts back-up screw

Ø ER		ER16	ER25	ER32
Order No.	85.800...	.34	.34	...35

Spare parts Coolant Tube

Ø ER		ER11	ER16	ER25	ER32
Order No.	85.700...	.40	.40	.40	.40

ER COLLET CHUCK HSK-A 50 · DIN 69893-1

CERTIFICATE OF QUALITY

- Chuck body fine balanced
G2.5 25,000 rpm
or U<1gmm
- All functional surfaces machined
- More accurate than DIN

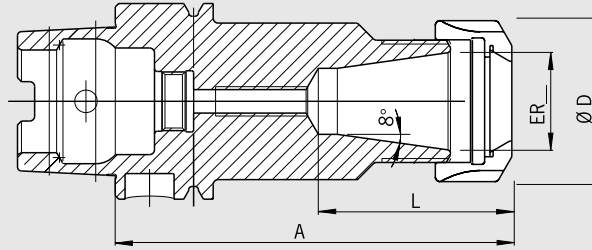

Use:







For clamping tools with cylindrical shank in ER collets according to ISO 15488.

- Locknut type HS (High-Speed, fine balanced, with slide coating for higher clamping forces)
- Increasing size L possible upon request

INCH	ER	ER11	ER16	ER25	ER32	ER40
	ØD [inch]	0.75	1.1	1.65	1.97	2.48
	Clamping range [inch]	0.02-0.28	0.02-0.39	0.04-0.63	0.06-0.79	0.10-1.02
	Clamping range [mm]	0.5-7.0	0.5-10.0	1.0-16.0	1.5-20.0	2.5-26.0
Form A50						
L [inch]		1.06	1.30	1.61	1.85	2.09
Gage length A [inch]	ultra short	2.36 ¹⁾	2.36 ¹⁾	2.76 ¹⁾	3.15 ¹⁾	3.15 ¹⁾
Order No.	A50.025...	.11	.16	.25	.32	.40
L [inch]		—	1.30	1.61	1.85	2.09
Gage length A [inch]	short		3.94	3.94	3.94	4.72
Order No.	A50.020...		.16	.25	.32	.40

Accessories

See accessories (pg. 143)

Spare parts Collet nut HS (Highspeed), fine-balanced						
Ø ER			ER16	ER25	ER32	ER40
Order No.	83.912...		.16.HS	.25.HS	.32.HS	.40.HS
Spare parts Wrench						
Ø ER			ER11	ER16		
Order No.	84.200...		.11	.16		
Spare parts Wrench						
Ø ER				ER25	ER32	ER40
Order No.	84.200...			...25	.32	.40
Spare parts Balancing index rings						
Ø ER			ER16	ER25	ER32	ER40
Order No.	79.350...		.28	.42	.48	.50
Spare parts Collet						
Ø ER						
See accessories 						
Spare parts back-up screw						
Ø ER			ER16	ER25	ER32	ER40
Order No.	85.800...		.34	.34	.35	.35
Spare parts Coolant Tube						
Ø ER			ER11	ER16	ER25	ER32
Order No.	85.700...		.40	.40	.40	.40

1) Without thread for back-up screw

FACE MILL ARBOR
 HSK-A 40 · DIN 69893-1

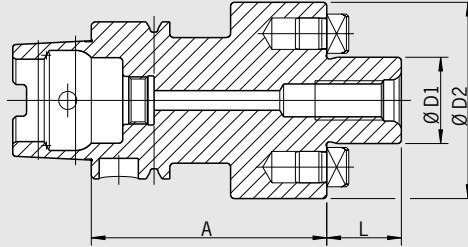

CERTIFICATE OF QUALITY	
<input checked="" type="checkbox"/>	Chuck body fine balanced G2.5 25,000 rpm or U<1gmm
<input checked="" type="checkbox"/>	All functional surfaces machined
<input checked="" type="checkbox"/>	More accurate than DIN

Use:

For holding face mill cutters and cutters with radial driving slot DIN 1880 and exceeding clamping diameter 40 clamping according to DIN 2079 is possible, too (4 additional tapping holes).
 With coolant exit bores on the end face for milling cutters with central cooling.

DIN 69882-3

- Included in delivery: tightening bolt, without coolant tube

METRIC	Ø D1 [mm]	16	22
	Ø D2 [mm]	36	48
	L [mm]	17	19
Gage length A [mm]	short	50	60
Order No.	A40.050...	.16.KKB	.22.KKB

Accessories

See accessories (pg. 143)

Spare parts Clamping Screw

Ø D1 [mm]		16	22
Order No.	85.300...	.16	.22

Spare parts Wrench

Ø D1 [mm]		16	22
Order No.	84.400...	.16	.22

Spare parts Balancing index rings

Ø D1 [mm]		16	22
Order No.	79.350...	.36	.48

Spare parts Coolant Tube

Ø D1 [mm]		16	22
Order No.	85.700...	.40	.40

Coolant bores

Order No.	91.100.03		
------------------	------------------	--	--

FACE MILL ARBOR
HSK-A 50 · DIN 69893-1

CERTIFICATE OF QUALITY

- Chuck body fine balanced
G2.5 25,000 rpm
or U<1gmm
- All functional surfaces machined
- More accurate than DIN

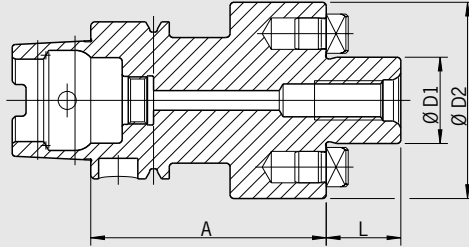

Use:

For holding face mill cutters and cutters with radial driving slot DIN 1880 and exceeding clamping diameter 40 clamping according to DIN 2079 is possible, too (4 additional tapping holes).
With coolant exit bores on the end face for milling cutters with central cooling.

DIN 69882-3

- Included in delivery: tightening bolt, without coolant tube

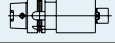
METRIC	Ø D1 [mm]	16	22	27	
	Ø D2 [mm]	36	48	60	
	L [mm]	17	19	21	
Gage length A [mm]	short		50	60	60
Order No.	A50.050...	.16.KKB	.22.KKB	.27.KKB	
Gage length A [mm]	long		100	100	100
Order No.	A50.051...	.16.KKB	.22.KKB	.27.KKB	

DIN 69893 HSK

Accessories

See accessories (pg. 143)

Spare parts Clamping Screw

Ø D1 [mm]		16	22	27
Order No.	85.300...	.16	.22	.27

Spare parts Wrench

Ø D1 [mm]		16	22	27
Order No.	84.400...	.16	.22	.27

Spare parts Balancing index rings

Ø D1 [mm]		16	22	27
Order No.	79.350...	.36	.48	.60

Spare parts Coolant Tube

Ø D1 [mm]		16	22	27
Order No.	85.700...	.40	.40	.40

Coolant bores

Order No.	91.100.03	
------------------	------------------	---

SHRINK FIT CHUCK
 HSK-A 63 · DIN 69893-1
 INCH

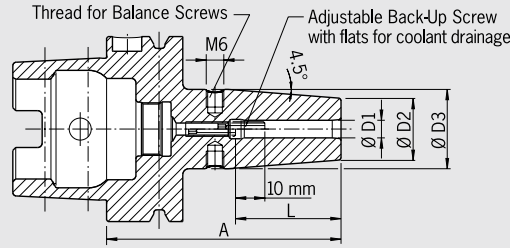

CERTIFICATE OF QUALITY	
<input checked="" type="checkbox"/>	Chuck body fine balanced G2.5 25,000 rpm or U<1 gmm
<input checked="" type="checkbox"/>	All functional surfaces machined
<input checked="" type="checkbox"/>	More accurate than DIN
<input checked="" type="checkbox"/>	Cool-Jet, can be sealed

Use:

Shrink fit chuck suitable for use with all available shrink fit units.

- Heat resistant hot-working steel
- Hardened 54-2 HRC
- For HSS and solid carbide tools
- Shank tolerance h6
- With threaded holes for balancing screws
- Cool-Jet coolant bores that can be sealed included

DIN 69893-1

Optional:

- Cooling with Cool Flash from 1/4" - 1" for an extra charge (See pp. 182/183)

Standard version

INCH	Clamping Ø D1 [inch]		1/8"	3/16"	1/4"	5/16"	3/8"	7/16"	1/2"	5/8"	3/4"	1"	1 1/4"
	Ø D2 [inch]		0.39	0.39	0.83	0.83	0.94	0.94	0.94	1.06	1.30	1.73	1.73
	Ø D3 [inch]		-	-	1.06	1.06	1.26	1.26	1.26	1.34	1.65	2.09	2.09
	L [inch]		0.35	0.47	1.42	1.42	1.65	1.65	1.85	1.97	2.05	2.28	2.28
Gage length A [inch]	short		3.15 ¹⁾	3.15 ¹⁾	3.15	3.15	3.35	3.35	3.54	3.74	3.94	4.53	4.72
Order No.	A63.140...		.1/8Z	.3/16Z	.1/4Z.4	.5/16Z.4	.3/8Z.4	.7/16Z.4	.1/2Z.4	.5/8Z.4	.3/4Z.4	.1Z.4	.1 1/4Z.4
Gage length A [inch]	ZG130		-	-	5.12	5.12	5.12	5.12	5.12	5.12	5.12	5.12	5.12
Order No.	A63.144...		-	-	.1/4Z.4	.5/16Z.4	.3/8Z.4	.7/16Z.4	.1/2Z.4	.5/8Z.4	.3/4Z.4	.1Z.4	.1 1/4Z.4
Gage length A [inch]	oversize		-	-	6.30	6.30	6.30	6.30	6.30	6.30	6.30	6.30	-
Order No.	A63.142...		-	-	.1/4Z.4	.5/16Z.4	.3/8Z.4	.7/16Z.4	.1/2Z.4	.5/8Z.4	.3/4Z.4	.1Z.4	-

Standard version with Safe-Lock™ and M3 seal screw installed

INCH	Clamping Ø D1 [inch]		1/4"	5/16"	3/8"	1/2"	5/8"	3/4"	1"	1 1/4"
	Ø D2 [inch]		0.83	0.83	0.94	0.94	1.06	1.30	1.73	1.73
	Ø D3 [inch]		1.06	1.06	1.26	1.26	1.34	1.65	2.09	2.09
	L [inch]		1.42	1.42	1.65	1.85	1.97	2.05	2.28	2.28
Gage length A [inch]	short		3.15 ²⁾	3.15 ²⁾	3.35 ²⁾	3.54 ²⁾	3.74 ²⁾	3.94 ²⁾	4.53 ²⁾	4.72 ²⁾
Order No.	A63.140...		.1/4Z.47	.5/16Z.47	.3/8Z.47	.1/2Z.47	.5/8Z.47	.3/4Z.47	.1Z.47	.1 1/4Z.47

Accessories

See accessories (pg. 143)

Spare parts Coolant Tube		
Order No.	85.700...	.63
Spare parts Set of Balance Screws		
See accessories		
Spare parts Back up screws		
See accessories		
Cool Flash		Order No. 91.100.40
		See pages 182/183

1) Without back-up screw, without threads for balancing screws, with slits along the clamping bore for coolant around the tool
 2) With tension spring

DIN 69893 HSK

SHRINK FIT CHUCK HSK-A 63 · DIN 69893-1 METRIC

CERTIFICATE OF QUALITY

- Chuck body fine balanced
G2.5 25,000 rpm
or U < 1 gmm
- All functional surfaces machined
- More accurate than DIN
- Cool-Jet, can be sealed

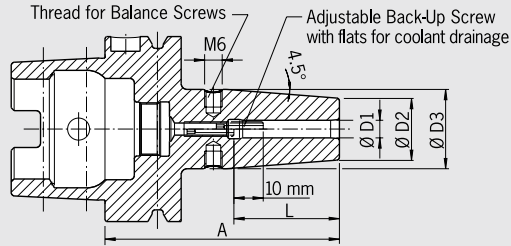

Use:

Shrink fit chuck suitable for use with all available shrink fit units.

- Heat resistant hot-working steel
- Hardened 54-2 HRC
- For HSS and solid carbide tools
- Shank tolerance h6
- With threaded holes for balancing screws
- Included in delivery: Shrink fit chuck with backup screw, without coolant tube

DIN 69893-1

Optional:

- Cooling with Cool-Jet for an extra charge (See page 180)
- Cooling with Cool Flash for an extra charge (See pp. 182/183)

Standard version, similar to DIN 69882-8

METRIC	Clamping Ø D1 [mm]		03	04	05	06	08	10	12	14	16	18	20	25	32
	Ø D2 [mm]		10	10	10	21	21	24	24	27	27	33	33	44	44
	Ø D3 [mm]		—	—	—	27	27	32	32	34	34	42	42	53	53
	L [mm]		09	12	15	36	36	42	47	47	50	50	52	58	58
Gage length A [mm]	short		80 ²⁾	80 ²⁾	80 ²⁾	80	80	85	90	90	95	95	100	115	120
Order No.	A63.140...		.03.1	.04.1	.05.1	.06	.08	.10	.12	.14	.16	.18	.20	.25	.32
Gage length A [mm]	ZG130		—	—	—	130	130	130	130	130	130	130	130	130	—
Order No.	A63.144...		—	—	—	.06	.08	.10	.12	.14	.16	.18	.20	.25	—
Gage length A [mm]	oversize		—	—	—	160	160	160	160	160	160	160	160	160	160
Order No.	A63.142...		—	—	—	.06	.08	.10	.12	.14	.16	.18	.20	.25	.32
Gage length A [mm]	ZG200		—	—	—	200	200	200	200	200	200	200	200	200	200
Order No.	A63.146...		—	—	—	.06	.08	.10	.12	.14	.16	.18	.20	.25	.32

Standard version, with Cool-Jet (Ø 3–5 mm Cooling with slits)

METRIC	Clamping Ø D1 [mm]		03	04	05	06	08	10	12	14	16	18	20	25	32
	Ø D2 [mm]		10	10	10	21	21	24	24	27	27	33	33	44	44
	Ø D3 [mm]		—	—	—	27	27	32	32	34	34	42	42	53	53
	L [mm]		09	12	15	36	36	42	47	47	50	50	52	58	58
Gage length A [mm]	short		80 ¹⁾	80 ¹⁾	80 ¹⁾	80	80	85	90	90	95	95	100	115	120
Order No.	A63.140...		.03	.04	.05	.06.2	.08.2	.10.2	.12.2	.14.2	.16.2	.18.2	.20.2	.25.2	.32.2
Gage length A [mm]	ZG130		—	—	—	130	130	130	130	130	130	130	130	130	—
Order No.	A63.144...		—	—	—	.06.2	.08.2	.10.2	.12.2	.14.2	.16.2	.18.2	.20.2	.25.2	—

Standard version, with Safe-Lock™ pull out protection

METRIC	Clamping Ø D1 [mm]		06	08	10	12	14	16	18	20	25	32
	Ø D2 [mm]		21	21	24	24	27	27	33	33	44	44
	Ø D3 [mm]		27	27	32	32	34	34	42	42	53	53
	L [mm]		36	36	42	47	47	50	50	52	58	58
Gage length A [mm]	short		80 ³⁾	80 ³⁾	85 ³⁾	90 ³⁾	90 ³⁾	95 ³⁾	95 ³⁾	100 ³⁾	115 ³⁾	120 ³⁾
Order No.	A63.140...		.06.7	.08.7	.10.7	.12.7	.14.7	.16.7	.18.7	.20.7	.25.7	.32.7

1) Without back-up screw, without threads for balancing screws, with slits along the clamping bore for cooling from outside
 2) Without back-up screw, without threads for balancing screws
 3) With tension spring

POWER SHRINK CHUCK
HSK-A 63 · DIN 69893-1

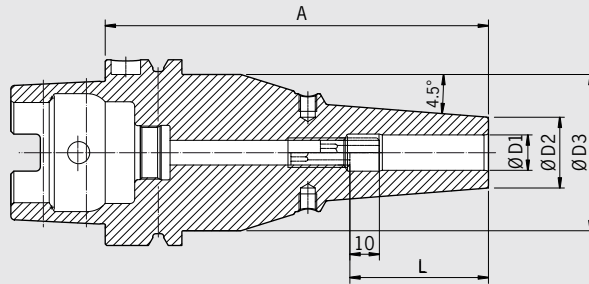

CERTIFICATE OF QUALITY	
<input checked="" type="checkbox"/>	Chuck body fine balanced G2.5 25,000 rpm or U < 1 gmm
<input checked="" type="checkbox"/>	All functional surfaces machined
<input checked="" type="checkbox"/>	More accurate than DIN
<input checked="" type="checkbox"/>	Cool-Jet, can be sealed

The Power Shrink Chuck is designed for the highest cutting performance in high-speed manufacturing. The optimized design combines high rigidity with vibration dampening, which protects the machine, spindle and tool.

- Highest cutting performance with higher spindle speeds, feeds and larger cutting depths, resulting in shorter cycle times
- Quieter running, therefore better surface quality and protection of tools, spindles and machines
- Higher machining accuracy
- With threaded holes for balancing screws

The long versions (A=120, 130 and 160) with slim tips are especially versatile to use.

- High rigidity and higher clamping forces
- Slim at the tip with a vibration dampening design
- Equally suited to high-speed manufacturing and heavy milling
- Universal usage, saves space in tool magazine

Optional:

- Cooling with Cool Flash for an extra charge (See pp. 182/183)
- Safe-Lock™ Pull out protection (See pages 184–187)

INCH	Clamping Ø D1 [inch]		1/4"	5/16"	3/8"	1/2"	5/8"	3/4"	1"	1 1/4"
	Ø D2 [inch] ultra short		0.87	0.87	1.04	1.04	1.16	1.40	1.77	1.77
	Ø D3 [inch] ultra short		—	—	—	—	—	—	2.01	2.01
	L [inch] ultra short		1.49	1.49	1.70	1.81	1.93	1.93	2.24	2.32
Gage length A [inch]	ultra short		2.76 ¹⁾	2.76 ¹⁾	2.76 ¹⁾	2.76 ¹⁾	2.95 ¹⁾	2.95 ¹⁾	3.35 ¹⁾	3.35 ¹⁾
Order No.	A63.145...		.1/4z.3	.5/16z.3	.3/8z.3	.1/2z.3	.5/8z.3	.3/4z.3	.1z.3	.1 1/4z.3
Safe-Lock™ Order No.	A63.145...		.1/4z.37	.5/16z.37	.3/8z.37	.1/2z.37	.5/8z.37	.3/4z.37	.1z.37	.1 1/4z.37
	Ø D2 [inch]		0.83	0.83	0.94	0.94	1.06	1.30	1.73	1.73
	Ø D3 [inch]		2.09	2.09	2.09	2.09	2.09	2.09	2.09	2.09
	L [inch]		1.42	1.42	1.65	1.85	1.97	2.05	2.28	2.28
Gage length A [inch]	ZG130		5.12	5.12	5.12	5.12	5.12	5.12	5.12	5.12
Order No.	A63.144...		.1/4z.3	.5/16z.3	.3/8z.3	.1/2z.3	.5/8z.3	.3/4z.3	.1z.3	.1 1/4z.3
Safe-Lock™ Order No.	A63.144...		.1/4z.37	.5/16z.37	.3/8z.37	.1/2z.37	.5/8z.37	.3/4z.37	.1z.37	.1 1/4z.37
Gage length A [inch]	oversize		6.30	6.30	6.30	6.30	6.30	6.30	6.30	6.30
Order No.	A63.142...		.1/4z.3	.5/16z.3	.3/8z.3	.1/2z.3	.5/8z.3	.3/4z.3	.1z.3	.1 1/4z.3
Safe-Lock™ Order No.	A63.142...		.1/4z.37	.5/16z.37	.3/8z.37	.1/2z.37	.5/8z.37	.3/4z.37	.1z.37	.1 1/4z.37

METRIC	Clamping Ø D1 [mm]		06	08	10	12	14	16	18	20	25	32
	Ø D2 [mm] ultra short		22	22	26.5	26.5	29.5	29.5	35.5	35.5	45	45
	Ø D3 [mm] ultra short		—	—	—	—	—	—	—	—	51	51
	L [mm] ultra short		38	38	43	46	48	49	49	49	57	59
Gage length A [mm]	ultra short		70 ¹⁾	70 ¹⁾	70 ¹⁾	70 ¹⁾	75 ¹⁾	75 ¹⁾	75 ¹⁾	75 ¹⁾	85 ¹⁾	85 ¹⁾
Order No.	A63.145...		.06.3	.08.3	.10.3	.12.3	.14.3	.16.3	.18.3	.20.3	.25.3	.32.3
Safe-Lock™ Order No.	A63.145...		.06.37	.08.37	.10.37	.12.37	.14.37	.16.37	.18.37	.20.37	.25.37	.32.37
	Ø D2 [mm]		21	21	24	24	27	27	33	33	44	44
	Ø D3 [mm]		53	53	53	53	53	53	53	53	53	53
	L [mm]		36	36	42	47	47	50	50	52	58	58
Gage length A [mm]	ZG120		120	120	120	120	120	120	120	120	120	120
Order No.	A63.147...		.06.3	.08.3	.10.3	.12.3	.14.3	.16.3	.18.3	.20.3	.25.3	.32.3
Safe-Lock™ Order No.	A63.147...		.06.37	.08.37	.10.37	.12.37	.14.37	.16.37	.18.37	.20.37	.25.37	.32.37
Gage length A [mm]	ZG130		130	130	130	130	130	130	130	130	130	130
Order No.	A63.144...		.06.3	.08.3	.10.3	.12.3	.14.3	.16.3	.18.3	.20.3	.25.3	.32.3
Safe-Lock™ Order No.	A63.144...		.06.37	.08.37	.10.37	.12.37	.14.37	.16.37	.18.37	.20.37	.25.37	.32.37
Gage length A [mm]	oversize		160	160	160	160	160	160	160	160	160	160
Order No.	A63.142...		.06.3	.08.3	.10.3	.12.3	.14.3	.16.3	.18.3	.20.3	.25.3	.32.3
Safe-Lock™ Order No.	A63.142...		.06.37	.08.37	.10.37	.12.37	.14.37	.16.37	.18.37	.20.37	.25.37	.32.37

HEAVY DUTY CHUCK HSK-A 63 · DIN 69893-1



CERTIFICATE OF QUALITY	
<input checked="" type="checkbox"/>	Chuck body fine balanced G2.5 25,000 rpm or U<1 gmm
<input checked="" type="checkbox"/>	All functional surfaces fine machined
<input checked="" type="checkbox"/>	More accurate than DIN
<input checked="" type="checkbox"/>	CoolJet, can be sealed

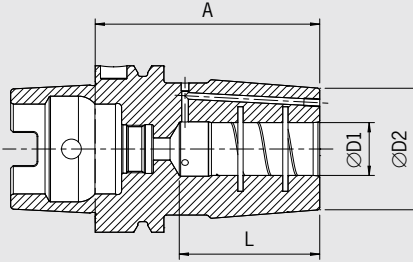

Finally there is a holder for heavy machining that can replace the Weldon tool holder. The Heavy Duty Chuck is a shrink fit chuck designed for extreme cases. The contour is optimized for highest rigidity and clamping force.

- Smooth clamping of the tool shank
- TIR less than 0.00012" (3 µm)
- Reinforced outer contour
- To shrink with HAIMER 13 kW HD Coil or 20 kW Shrink Fit Machine
- With internal groove in the clamping bore

- With threaded holes for balancing screws
- Cool-Jet coolant bores that can be sealed included

Optional:

- Cooling with Cool Flash for an extra charge (See pp. 182/183)
- Safe-Lock™ Pull out protection (See pages 184–187)

INCH	Clamping Ø D1 [inch]	5/8"	3/4"
	Ø D2 [inch]	1.81	1.81
	L [inch]	2.01	2.08
Gage length A [inch]	ultra short	3.15	3.15
Order No.	A63.145...	.5/8z.6	.3/4z.6
Safe-Lock™ Order No.	A63.145...	.5/8z.67	.3/4z.67
Gage length A [inch]	short	3.35	3.35
Order No.	A63.140...	.5/8z.6	.3/4z.6
Safe-Lock™ Order No.	A63.140...	.5/8z.67	.3/4z.67

METRIC	Clamping Ø D1 [mm]	16	20
	Ø D2 [mm]	46	46
	L [mm]	51	53
Gage length A [mm]	ultra short	80	80
Order No.	A63.145...	.16.6	.20.6
Safe-Lock™ Order No.	A63.145...	.16.67	.20.67
Gage length A [mm]	short	85	85
Order No.	A63.140...	.16.6	.20.6
Safe-Lock™ Order No.	A63.140...	.16.67	.20.67

Accessories

Cool Flash



Order No. 91.100.40

See pages 182/183

MINI SHRINK
HSK-A 63 · DIN 69893-1

– It is imperative that the correct adapter be used for both heating and cooling with all “Mini Shrink” chucks, in order to prevent overheating of the chuck.

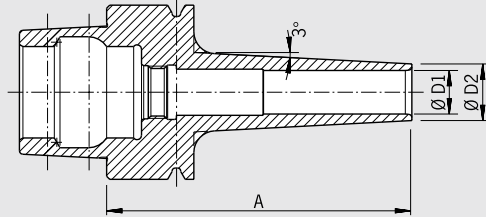

CERTIFICATE OF QUALITY

- Chuck body fine balanced
G2.5 25,000 rpm
or U<1gmm
- All functional surfaces machined
- More accurate than DIN

- Extreme slim design
- No disturbing edges
- TIR less than 0.00012" (3 µm)
- Ideal for the HAIMER Power Clamp
- For all solid carbide tools with shank tolerance h6
- With 3° slope for dies and molds

- With high clamping force
- Tool holders fine balanced
- Delivery without coolant tube
- Attention:** Heating and cooling only with shrink and cooling sleeves (see accessories)

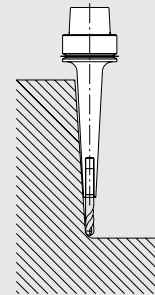
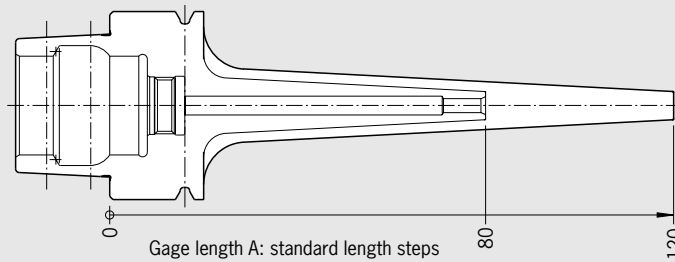

METRIC	Clamping Ø D1 [mm]		06	08	10	12
	Ø D2 extra slim [mm]		09	11	13	15
Gage length A [mm]	ZG80		80	80	80	80
Order No.	extra slim A63.173...		.06	.08	.10	.12
Gage length A [mm]	ZG120		120	120	120	120
Order No.	extra slim A63.177...		.06	.08	.10	.12

Shrink and cooling sleeve

- Protects Mini Shrink chucks from overheating
- Extends lifetime of shrink fit chucks
- Secure and user friendly handling
- Cooling with standard cooling body



Function

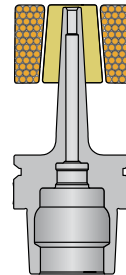
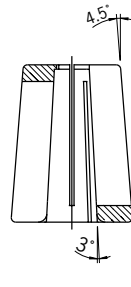

Heat up
With shrink and cooling sleeve

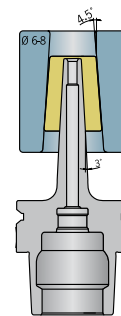

Cool down
With shrink and cooling sleeve
and cooling body Ø 6–8 mm

POWER MINI SHRINK CHUCK
HSK-A 63 · DIN 69893-1

CERTIFICATE OF QUALITY	
<input checked="" type="checkbox"/>	Chuck fine balanced G2.5 25,000 rpm
<input checked="" type="checkbox"/>	All functional surfaces fine machined
<input checked="" type="checkbox"/>	More accurate than DIN

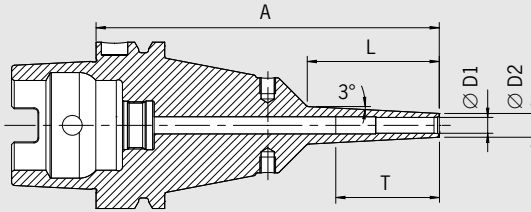

The Power Mini Shrink Chuck is perfect for 5-axis-machining in the die & mold and in the medical industry. Very slim at the top like the HAIMER Mini Shrink Chucks, the Power Mini Shrink is reinforced at the base. This allows for efficient milling with an angled tool even at long protruding lengths.

- 2 types: Standard (3 mm wall thickness) and extra slim (1.5 mm wall thickness)
- 3° slope at the top
- With threaded holes for balancing screws
- For solid carbide tools with shank tolerance h6
- **Attention: Shrinking only with shrink and cooling adapter**

CERTIFICATE OF QUALITY	
<input checked="" type="checkbox"/>	Chuck fine balanced G2.5 25,000 rpm
<input checked="" type="checkbox"/>	All functional surfaces fine machined
<input checked="" type="checkbox"/>	More accurate than DIN

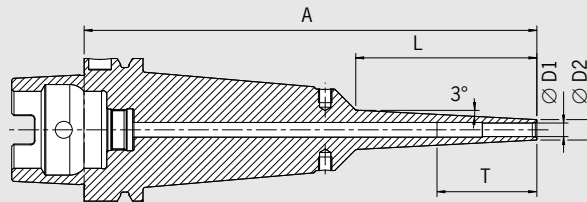

HSK-A63

METRIC	Clamping Ø D1 [mm]		03	04	05	06	08	10	12	16
	Ø D2 [mm] standard		09	10	11	12	14	16	18	24
	Ø D2 [mm] extra slim		06	07	08	09	11	13	15	—
	T [mm]		—	—	—	—	—	68	75	75
	L [mm] ZG130		50	50	50	50	50	50	50	50
Gage length A [mm]	ZG130		130	130	130	130	130	130	130	130
Order No.	standard	A63.184...	.03.8	.04.8	.05.8	.06.8	.08.8	.10.8	.12.8	.16.8
Order No.	extra slim	A63.174...	.03.8	.04.8	.05.8	.06.8	.08.8	.10.8	.12.8	—
	L [mm] oversize/ZG200		80	80	80	80	80	80	80	80
Gage length A [mm]	oversize		160	160	160	160	160	160	160	160
Order No.	standard	A63.182...	.03.8	.04.8	.05.8	.06.8	.08.8	.10.8	.12.8	.16.8
Order No.	extra slim	A63.172...	.03.8	.04.8	.05.8	.06.8	.08.8	.10.8	.12.8	—
Gage length A [mm]	ZG200		200	200	200	200	200	200	200	200
Order No.	standard	A63.186...	.03.8	.04.8	.05.8	.06.8	.08.8	.10.8	.12.8	.16.8
Order No.	extra slim	A63.176...	.03.8	.04.8	.05.8	.06.8	.08.8	.10.8	.12.8	—

POWER COLLET CHUCK
HSK-A 63 · DIN 69893-1

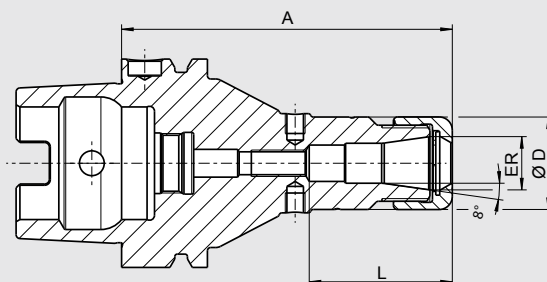

CERTIFICATE OF QUALITY	
<input checked="" type="checkbox"/>	Chuck fine balanced G2.5 25,000 rpm or U < 1 gmm
<input checked="" type="checkbox"/>	All functional surfaces fine machined
<input checked="" type="checkbox"/>	More accurate than DIN

The Power Collet Chuck is designed for the highest machining capacity in high-speed manufacturing. The optimized design with improved construction combines high rigidity with vibration dampening features, giving more protection to the machine, spindle and tool.

The universal Power Collet Chuck is a unique high performance chuck that can also be used with standard collets.

- High runout accuracy: < 0.00012" (3µm) at 3 x D with HAIMER Power Collets
- Also for standard collets ER according to ISO 15488 (formerly DIN 6499)
(Attention: By using standard collet ER length A will increase)
- High rigidity

- Runs smoother thanks to vibration absorbing geometry, yielding better surface finish and increased tool, spindle and machine protection
- Highest cutting performance with higher spindle speeds, higher feeds and larger cutting depths
- Shorter cycle times, higher machining accuracy, higher clamping forces
- Equally suited to high-speed manufacturing and heavy milling
- With threaded holes for balancing screws
- Optional: Cool-Jet bores on Power Collets from ER 25 Ø 1/4"
- Program of Power Collets on pages 154 – 157

INCH	ER	16	25	32
	Ø D [inch]	1.1	1.65	1.97
	Clamping range [inch]	1/8"-3/8"	1/8"-5/8"	1/8"-3/4"
	L [inch] ultra short	1.69	1.97	1.87
Gage length A [inch]	ultra short	2.95	2.95	2.95
Order No.	A63.025...	.16.3 ¹⁾	.25.3 ¹⁾	.32.3 ¹⁾
	L [inch]	1.69	2.01	2.09
Gage length A [inch]	short	3.94	3.94	3.94
Order No.	A63.020...	.16.3	.25.3	.32.3
Gage length A [inch]	oversize	6.30	6.30	6.30
Order No.	A63.022...	.16.3	.25.3	.32.3

Accessories

Locknut (fine-balanced)

Size	ER 16	ER 25	ER 32	
Order No. 83.914...	.16	.25	.32	
Clamping wrench				See page 158

Torque Master torque wrench for Power Collet Chucks

Order No. 84.600.00 See page 158

Power Collets See page 154

Power Collets with Safe-Lock™ See page 156

Cool-Jet bores for Power Collets
Order No. 91.100.27 See page 157

ER COLLET CHUCK HSK-A 63 · DIN 69893-1

CERTIFICATE OF QUALITY

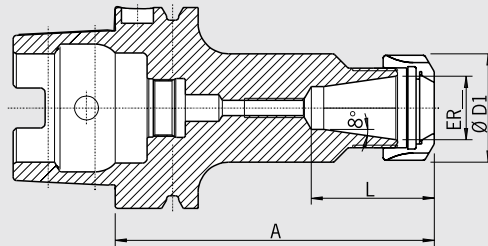

- Chuck fine balanced
G2.5 25,000 rpm or U<1 gmm
- All functional surfaces fine machined
- More accurate than DIN



Use:





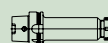



For clamping tools with cylindrical shank in ER collets according to ISO 15488. – Increasing size L possible upon request

- Locknut (balanced, with slide coating for higher clamping forces); without coolant tube
- Locknut type HS (High-Speed, fine balanced, with slide coating for higher clamping forces) for an extra charge

INCH	ER	ER11	ER16	ER25	ER32	ER40
	ØD [inch]	0.75	1.1	1.65	1.97	2.48
	Clamping range [inch]	0.02–0.28	0.02–0.39	0.04–0.63	0.06–0.79	0.09–1.02
	Clamping range [mm]	0.5–7.0	0.5–10.0	1.0–16.0	1.5–20.0	2.5–26.0
L [inch]		1.03	1.81	1.83	1.85	2.09
Gage length A [inch]	ultra short 	2.95	2.95	2.95	2.95	3.35
Order No.	A63.025...	.11 ¹⁾	.16 ¹⁾	.25 ¹⁾	.32 ¹⁾	.40 ¹⁾
L [inch]		²⁾ 3.94	1.28	1.61	1.85	2.09
Gage length A [inch]	short 	3.94	3.94	3.94	3.94	4.72
Order No.	A63.020...	.11	.16	.25	.32	.40
L [inch]		–	1.28	1.61	1.85	2.09
Gage length A [inch]	oversize 	–	6.30	6.30	6.30	6.30
Order No.	A63.022...	–	.16	.25	.32	.40

Accessories

See accessories (pg. 143)

Spare parts Collet nut, Pre-balanced						
Ø ER		ER11	ER16	ER25	ER32	ER40
Order No.	83.912... 	.11	.16	.25	.32	.40
Spare parts Collet nut HS (Highspeed), fine-balanced						
Ø ER			ER16	ER25	ER32	ER40
Order No.	83.912... 		.16.HS	.25.HS	.32.HS	.40.HS
Spare parts Wrench						
Ø ER		ER11	ER16	–	–	–
Order No.	84.200... 	.11	.16			
Spare parts Wrench						
Ø ER		–	–	ER25	ER32	ER40
Order No.	84.200... 			.25	.32	.40
Spare parts Balancing index rings						
Ø ER		ER11	ER16	ER25	ER32	ER40
Order No.	79.350... 	.19	.28	.42	.48	.50
Spare parts Collet						
Ø ER						
See accessories 						
Spare parts Adjusting Screw						
Ø ER		–	ER16	ER25	ER32	ER40
Order No.	85.800... 		.34	.34	.35	.35
Spare parts Coolant Tube						
Ø ER		ER11	ER16	ER25	ER32	ER40
Order No.	85.700... 	.63	.63	.63	.63	.63

1) Without thread for back-up screw 2) Drilled through

HG COLLET CHUCK
 HSK-A 63 · DIN 69893-1

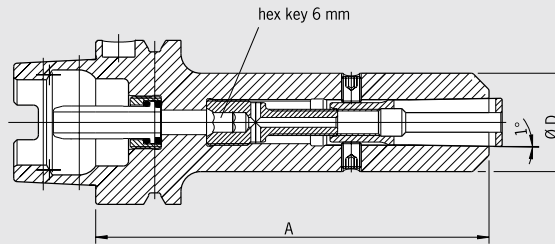

CERTIFICATE OF QUALITY	
<input checked="" type="checkbox"/>	Chuck body fine balanced G2.5 25,000rpm or U<1gmm
<input checked="" type="checkbox"/>	All functional surfaces machined
<input checked="" type="checkbox"/>	More accurate than DIN

Use:

For high-precise clamping of tools with cylindrical shank, also with clamping flats.
 Very useful for high-speed machining.

- Included in delivery: high-precision chuck with clamping screw and pull-out hook, without collet, without coolant tube
- Shank tolerance h6
- Optional: Cool-Jet bores on HG Collets from diam. 1/4"
- Extensions for High-Precision Chuck available

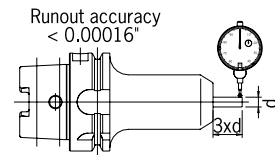

INCH	HG		01	02	03
	ØD [inch]		1.18	1.38	1.89
	Clamping range [inch] shank tolerance h6		0.08–0.35	0.375–0.57	0.625–0.79
Gage length A [inch]	short		4.72	4.72	4.72
Order No.	A63.120...		.01	.02	.03
Gage length A [inch]	oversize		6.30	6.30	6.30
Order No.	A63.122...		.01	.02	.03

Accessories

See accessories (pg. 143)

Spare parts Collet

HG
 See accessories

Spare parts Locking Screw

HG short HG 01 HG 02 HG 03
 Order No. 82.560... .02 .14 .14

HG oversize HG 01 HG 02 HG 03
 Order No. 82.560... .04 .01 .01

Spare parts Balancing index rings

HG HG 01 HG 02 HG 03
 Order No. 79.350... .30 .35 .48

Spare parts Coolant Tube

HG HG 01 HG 02 HG 03
 Order No. 85.700... .63 .63 .63

FACE MILL ARBOR HSK-A 63 · DIN 69893-1

CERTIFICATE OF QUALITY

- Chuck body fine balanced
G2.5 25,000 rpm
or U<1gmm
- All functional surfaces machined
- More accurate than DIN

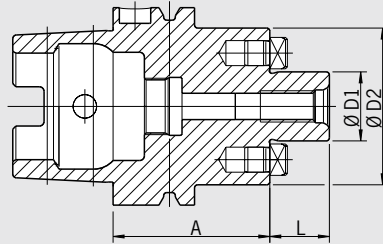

Use:

For clamping face-mill cutters.

With coolant exit bores on the end face for milling cutters with central cooling

- Included in delivery: tightening bolt, without coolant tube
- Inch sizes: Coolant bores on front side for an extra charge

INCH	Ø D1 [inch]		3/4"	1"	1 1/4"	1 1/2"
	L [inch]		0.70	0.70	0.70	0.94
	Ø D2 [inch]		1.67	1.67	1.67	3.78
Gage length A [inch]	short		1.97	2.36	2.36	2.36
Order No.	A63.050...		.3/4Z	.1Z	.1 1/4Z	.1 1/2Z
Gage length A [inch]	long		3.94	3.94	3.94	3.94
Order No.	A63.051...		.3/4Z	.1Z	.1 1/4Z	.1 1/2Z
Gage length A [inch]	oversize		6.30	6.30	-	-
Order No.	A63.052...		.3/4Z	.1Z		

METRIC	Clamping Ø D1 [mm]		16	22	27	32	40
	L [mm]		17	19	21	24	27
	Ø D2 [mm]		36	48	60	78	87
Gage length A [mm]	short		50	50	60	60	60
Order No.	A63.050...		.16.KKB	.22.KKB	.27.KKB	.32.KKB	.40.KKB
Gage length A [mm]	long		-	100	100	100	100
Order No.	A63.051...			.22.KKB	.27.KKB	.32.KKB	.40.KKB
Gage length A [mm]	oversize		-	160	160	160	-
Order No.	A63.052...			.22.KKB	.27.KKB	.32.KKB	

Accessories

See accessories (pg. 143)

Spare parts Clamping Screw

Ø D1 [inch]			3/4"	1"	1 1/4"	1 1/2"
Order No.	85.300...		.3/4Z	.1Z	.11/4Z	.11/2Z

Spare parts Wrench

Ø D1 [inch]			3/4"	1"	1 1/4"	1 1/2"
Order No.	84.400...		.3/4Z	.1Z	.11/4Z	.11/2Z

Spare parts Balancing index ring

Ø D1 [inch]			3/4"	1"	-	-
Order No.	79.350...		.1.71Z	.55		

Spare parts Coolant Tube

Ø D1 [inch]			3/4"	1"	1 1/4"	1 1/2"
Order No.	85.700...		.63	.63	.63	.63

Coolant bores

Order No.	91.100.03					
-----------	-----------	--	--	--	--	--

Accessories

See accessories (pg. 143)

Spare parts Clamping Screw

Ø D1 [mm]			16	22	27	32	40
Order No.	85.300...		.16	.22	.27	.32	.40

Spare parts Wrench

Ø D1 [mm]			16	22	27	32	40
Order No.	84.400...		.16	.22	.27	.32	.40

Spare parts Balancing index ring

Ø D1 [mm]			16	22	27	32	40
Order No.	79.350...		.36	.48	.60	.78	.87

Spare parts Coolant Tube

Ø D1 [mm]			16	22	27	32	40
Order No.	85.700...		.63	.63	.63	.63	.63

ADAPTER FOR MORSE TAPER WITH TANG
 HSK-A 63 · DIN 69893-1

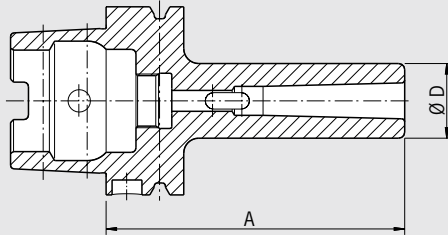

CERTIFICATE OF QUALITY
 Chuck balanced
 G6.3 8.000 rpm
 All functional surfaces fine machined
 More accurate than DIN

Use:

For holding tools with morse taper and tang according to DIN 228-1 form B.

– Fine-balancing for an extra charge

MK		01	02	03	04
Ø D [mm]		25	32	40	48
Form A63					
Gage Length A [mm]	short	100	120	140	160
Order No.	A63.080...	.01	.02	.03	.04

Accessories

Balancing index rings

MK		01	02	03	04
Order No.	79.350...	.25	.32	.40	.48
Coolant tube					
Order No.	85.700.63				

ADAPTER FOR MORSE TAPER WITH THREAD HSK-A 63 · DIN 69893-1

CERTIFICATE OF QUALITY

- Chuck balanced
G6.3 8.000 rpm
- All functional surfaces fine machined
- More accurate than DIN

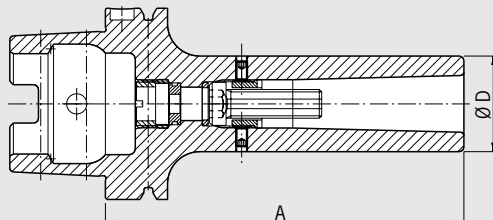

Use:

For holding tools with morse taper with thread according to DIN 228-1 form A.

- Fine-balancing for an extra charge
- Delivery with tightening bolt without coolant tube

MK		02	03	04
Ø D [mm]		32	40	48
Form A63				
Gage Length A [mm]	short	120	140	160
Order No.	A63.130...	.02	.03	.04

Accessories

Balancing index rings

MK		02	03	04
Order No.	79.350...	.32	.40	.48
Coolant tube				
Order No.	85.700.63			

BLANK ADAPTER
 HSK-A 63 · DIN 69893-1

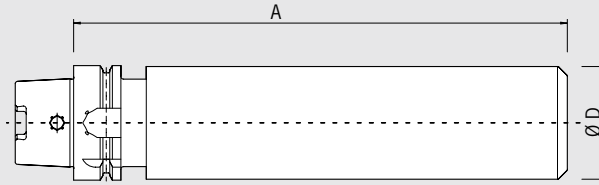

CERTIFICATE OF QUALITY
 All functional surfaces fine machined
 More accurate than DIN

Use:
 For manufacturing special tools in your own factory.

Design:
 HSK is hardened and ground, the cylindrical part is soft.

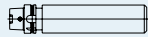
Ø D [mm]		64	
Form A63			
Gage Length A [mm]	ZG250		250
Order No.	A63.090...		.64

DIN 69893 HSK

STANDARD SHRINK FIT CHUCK HSK A63/80 (TAPER 63 mm/FLANGE 80 mm)

CERTIFICATE OF QUALITY

- Chuck body fine balanced
G2.5 33,000 rpm or U < 1 gmm
- All functional surfaces fine machined
- More accurate than DIN

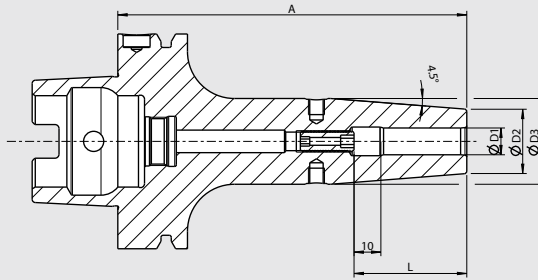

Use:

Suitable for all shrinking units.

DIN 69893-1

- With threaded holes for balancing screws
- Included in delivery: Shrink fit chuck with backup screw, without coolant tube
- Heat resistant hot-working steel
- Hardened 54–2 HRC
- For HSS and solid carbide tools
- Shank tolerance h6
- Cooling Systems Cool-Jet and Cool Flash available on request

Standard version, similar to DIN 69882-8

INCH	Clamping \varnothing D1 [inch]		1/4	5/16	3/8	1/2	5/8
	\varnothing D2 [inch]		0.83	0.83	0.94	0.94	1.06
	\varnothing D3 [inch]		1.06	1.06	1.26	1.26	1.34
	L [inch]		1.42	1.42	1.65	1.85	1.97
Length A [inch]	ZG130		5	5	5	5	5
Order No.	A63/80.144...		.1/4z.i	.5/16z.i	.3/8z.i	.1/2z.i	5/8z.i

METRIC	Clamping \varnothing D1 [mm]		06	08	10	12	16
	\varnothing D2 [mm]		21	21	24	24	27
	\varnothing D3 [mm]		27	27	32	32	34
	L [mm]		36	36	42	47	50
Length A [mm]	ZG130		130	130	130	130	130
Order No.	A63/80.144...		.06	.08	.10	.12	.16

Accessories

Shrink fit extensions



Balance screws



Order No. 80.203.00

Cool-Jet bores

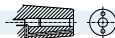

Order No. 91.100.24

Cool Flash Upgrade incl. Cool-Jet



Order No. 91.100.41

Balluff-Chip BIS-C-122-04/L



Order No. 909009-0002

Coolant tube



Order No. 85.700.63

Reduction sleeves



Back-up screws



Cooling grooves on request

POWER SHRINK CHUCK
HSK A63/80 (TAPER 63 mm/FLANGE 80 mm) – INCH

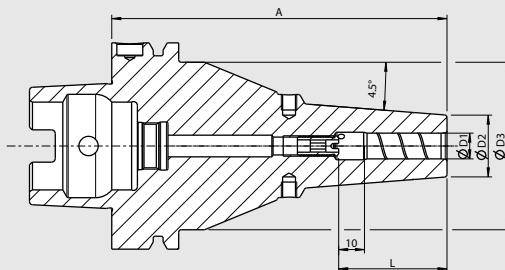

CERTIFICATE OF QUALITY	
<input checked="" type="checkbox"/>	Chuck body fine balanced G2.5 33,000 rpm or U < 1 gmm
<input checked="" type="checkbox"/>	All functional surfaces fine machined
<input checked="" type="checkbox"/>	More accurate than DIN

The Power Shrink Chuck is designed for the highest cutting performance in high-speed manufacturing. The optimized design combines high rigidity with vibration dampening, which protects the machine, spindle and tool.

- Highest cutting performance with higher spindle speeds, higher feeds and larger cutting depths
- Shorter cycle times
- Higher machining accuracy

Delivery includes:

- Cool-Jet bores (sealed)
- With threaded holes for balancing screws
- Incl. pocket for data chip
- With thread for coolant tube

Clamping	Ø D1 [inch]	1/4	5/16	3/8	1/2	5/8	3/4	1	
	Ø D2 [inch]	0.87	0.87	1.04	1.04	1.16	1.40	1.81	
	L [inch] extra ultra short	—	—	—	—	—	1.71	1.85	
Length A [inch]	extra ultra short							2.75	2.75
Order No.	A63/80.145...							.3/4z.5.i	.1z.5.i
	Ø D2 [inch]	0.87	0.87	1.04	1.04	1.16	1.40	1.77	
	L [inch] ultrashort	1.50	1.50	1.69	1.81	1.93	1.93	2.24	
Length A [inch]	ultra short							3	3
Order No.	A63/80.145...	.1/4z.3.i	.5/16z.3i	.3/8z.3.i	.1/2z.3.i	.5/8z.3.i	.3/4z.3.i	.1z.3.i	
Length A [inch]	short								3.5
Order No.	A63/80.140...								.1z.3.i

Length A = ZG130

Clamping	Ø D1 [inch]	1/4	5/16	3/8	1/2	5/8			
	Ø D2 [inch]	0.83	0.83	0.94	0.94	1.06			
	Ø D2 [inch]	2.56	2.56	2.56	2.56	2.56			
	L [inch]	1.42	1.42	1.65	1.85	1.97			
Length A [inch]	ZG130							5")	5")
Order No.	A63/80.144...	.1/4z.3.i	.5/16z.3.i	.3/8z.3.i	.1/2z.3.i	.5/8z.3.i			

Accessories

Shrink fit extensions



Balance screws



Order No. 80.203.00

Cool Flash



Order No. 91.100.40

Balluff-Chip



Order No. 909009-0002

Coolant tube



Order No. 85.700.63

Cooling adapters for extra ultra short holders

Size

Ø 20

Ø 25

Order No. 80.105...

.16.0045

.18.0011

Cooling grooves on request

POWER SHRINK CHUCK WITH SAFE-LOCK® HSK A63/80 (TAPER 63 mm/FLANGE 80 mm) – INCH

CERTIFICATE OF QUALITY	
<input checked="" type="checkbox"/>	Chuck body fine balanced G2.5 33,000 rpm or U<1 gmm
<input checked="" type="checkbox"/>	All functional surfaces fine machined
<input checked="" type="checkbox"/>	More accurate than DIN

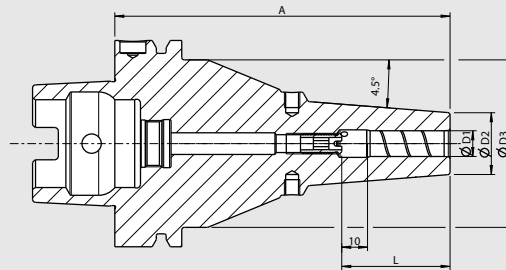

The Power Shrink Chuck is designed for the highest cutting performance in high-speed manufacturing. The optimized design combines high rigidity with vibration dampening, which protects the machine, spindle and tool.

- Highest cutting performance with higher spindle speeds, higher feeds and larger cutting depths
- Shorter cycle times
- Higher machining accuracy

Delivery includes:

- Safe-Lock™ pull-out protection
- Cool-Jet bores (sealed)
- With threaded holes for balancing screws
- Incl. pocket for data chip
- With thread for coolant tube

Clamping	Ø D1 [inch]	1/2	5/8	3/4	1
	Ø D2 [inch] extra ultra short			1.40	1.77
	L [inch] extra ultra short			1.93	2.24
Length A [inch]	extra ultra short			2.75	2.75
Order No.	A63/80.145...			.3/4z.57.i	.1z.57.i
	Ø D2 [inch]	1.04	1.16	1.40	1.77
	L [inch]	1.81	1.93	1.93	2.24
Length A [inch]	ultra short	3	3	3	3
Order No.	A63/80.145...	.1/2z.37.i	.5/8z.37.i	.3/4z.37.i	.1z.37.i
Length A [inch]	short				3.5
Order No.	A63/80.140...				.1z.37.i

Length A = ZG130

Clamping	Ø D1 [inch]	1/2	5/8
	Ø D2 [inch]	0.94	1.06
	Ø D3 [inch]	2.56	2.56
	L [inch]	1.85	1.97
Length A [inch]	ZG130	5 ¹⁾	5 ¹⁾
Order No.	A63/80.144...	.1/2z.37.i	.5/8z.37.i

Accessories

Shrink fit extensions		
Balance screws		Order No. 80.203.00
Cool Flash		Order No. 91.100.40
Balluff-Chip		Order No. 909009-0002
Coolant tube		Order No. 85.700.63

Cooling adapters for extra ultra short holders

Size	Ø 20	Ø 25
Order No.	80.105...	.16.0045 .18.0011

POWER SHRINK CHUCK
HSK A63/80 (TAPER 63 mm/FLANGE 80 mm) – METRIC

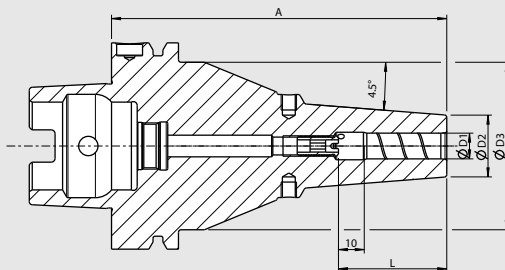

CERTIFICATE OF QUALITY	
<input checked="" type="checkbox"/>	Chuck body fine balanced G2.5 33,000 rpm or U < 1 gmm
<input checked="" type="checkbox"/>	All functional surfaces fine machined
<input checked="" type="checkbox"/>	More accurate than DIN

The Power Shrink Chuck is designed for the highest cutting performance in high-speed manufacturing. The optimized design combines high rigidity with vibration dampening, which protects the machine, spindle and tool.

- Highest cutting performance with higher spindle speeds, higher feeds and larger cutting depths
- Shorter cycle times
- Higher machining accuracy

Delivery includes:

- Cool-Jet bores (sealed)
- With threaded holes for balancing screws
- Incl. pocket for data chip
- With thread for coolant tube

Standard version, similar to DIN 69882-8

Clamping	Ø D1 [mm]	06	08	10	12	16	20	25	32
	Ø D2 [mm] extra ultra short	22	22	27	26.5	29.5	35.5	46	
	L [mm] extra ultra short	—	—	41	—	—	43.5	47	
Length A [mm]	extra ultra short			65			70	70	
Order No.	A63/80.145...			.10.5			.20.5	.25.5	
	Ø D2 [mm]	22	22	26.5	26.5	29.5	35.5	45	45
	L [mm]	38	38	43	46	49	49	57	59
Length A [mm]	ultra short	70	70	70	70	75	75	80	
Order No.	A63/80.145...	.06.3	.08.3	.10.3	.12.3	.16.3	.20.3	.25.3	
Length A [mm]	short							90	90
Order No.	A63/80.140...							.25.3	.32.3

Length A = ZG130

Clamping	Ø D1 [mm]	06	08	10	12	16
	Ø D2 [mm]	21	21	24	24	27
	Ø D3 [mm]	65	65	65	65	65
	L [mm]	36	36	42	47	50
Length A [mm]	ZG130	130	130	130	130	130
Order No.	A63/80.144...	.06.3 ¹⁾	.08.3 ¹⁾	.10.3 ¹⁾	.12.3 ¹⁾	.16.3 ¹⁾

Accessories

Shrink fit extensions



Balance screws



Order No. 80.203.00

Cool Flash



Order No. 91.100.40

Balluff-Chip BIS-C-122-04/L



Order No. 909009-0002

Coolant tube



Order No. 85.700.63

Cooling adapters for extra ultra short holders

Size

Ø 20

Ø 25

Order No. 80.105...

.16.0045

.18.0011

Cooling grooves on request

POWER SHRINK CHUCK WITH SAFE-LOCK®
HSK A63/80 (TAPER 63 mm/FLANGE 80 mm) – METRIC

CERTIFICATE OF QUALITY

- Chuck body fine balanced
G2.5 33,000 rpm or U < 1 gmm
- All functional surfaces fine machined
- More accurate than DIN

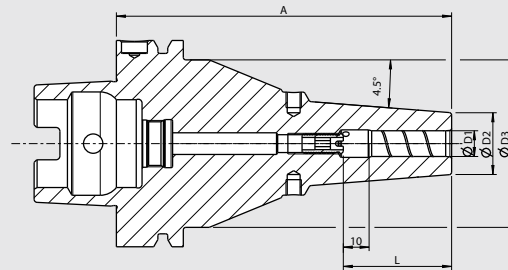

The Power Shrink Chuck is designed for the highest cutting performance in high-speed manufacturing. The optimized design combines high rigidity with vibration dampening, which protects the machine, spindle and tool.

- Highest cutting performance with higher spindle speeds, higher feeds and larger cutting depths
- Shorter cycle times
- Higher machining accuracy

Delivery includes:

- Safe-Lock™ pull-out protection
- Cool-Jet bores (sealed)
- With threaded holes for balancing screws
- Incl. pocket for data chip
- With thread for coolant tube

Standard version, similar to DIN 69882-8

Clamping	Ø D1 [mm]			12	16	20	25
	Ø D2 [mm] extra ultra short					35.5	46
	L [mm] extra ultra short					43.5	47
Length A [mm]	extra ultra short					70	70
Order No.	A63/80.145...					.20.57	.25.57
	Ø D2 [mm]			26.5	29.5	35.5	45
	L [mm]			46	49	49	57
Length A [mm]	ultra short			70	75	75	80
Order No.	A63/80.145...			.12.37	.16.37	.20.37	.25.37
Length A [mm]	short						90
Order No.	A63/80.140...						.25.37

Length A = ZG130

Clamping	Ø D1 [mm]			12	16		
	Ø D2 [mm]			24	27		
	Ø D3 [mm]			65	65		
	L [mm]			47	50		
Length A [mm]	ZG130			130 ¹⁾	130 ¹⁾		
Order No.	A63/80.144...			.12.37	.16.37		

Accessories

Shrink fit extensions							
Balance screws		Order No. 80.203.00					
Cool Flash		Order No. 91.100.40					
Balluff-Chip BIS-C-122-04/L		Order No. 909009-0002					
Coolant tube		Order No. 85.700.63					
Cooling adapters for extra ultra short holders							
Size		Ø 20	Ø 25				
Order No.	80.105...	.16.0045	.18.0011				

POWER MINI SHRINK
HSK A63/80 (TAPER 63 mm/FLANGE 80 mm)

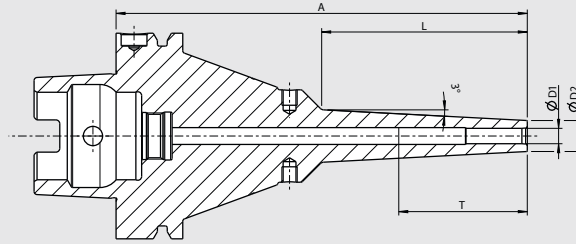

CERTIFICATE OF QUALITY	
<input checked="" type="checkbox"/>	Chuck body fine balanced G2.5 33,000 rpm or U < 1 gmm
<input checked="" type="checkbox"/>	All functional surfaces fine machined
<input checked="" type="checkbox"/>	More accurate than DIN

Power Mini Shrink Chuck is perfect for 5-axis-machining of parts that are difficult to access. Very slim at the top like the HAIMER Mini Shrink Chucks, the Power Mini Shrink is reinforced at the base. This allows for efficient milling with an angled tool even at long protruding lengths.

- 3 mm wall thickness
- 3° slope at the top
- With threaded holes for balancing screws
- For solid carbide tools with shank tolerance h6
- **Attention: Shrinking only with shrink and cooling adapter**

INCH	Clamping Ø D1 [inch]	1/8	1/4	5/16	3/8	1/2
	Ø D2 [inch]	0.35	0.47	0.55	0.63	0.71
	T [inch]	—	—	—	2.68	2.95
	L [inch]	3.15	3.15	3.15	3.15	3.15
Length A [inch]	oversize	6.5	6.5	6.5	6.5	6.5
Order No.	A63/80.182...	.1/8z.8.i	.1/4z.8.i	.5/16z.8.i	.3/8z.8.i	.1/2z.8.i

METRIC	Clamping Ø D1 [mm]	03	04	05	06	08	10	12
	Ø D2 [mm]	09	10	11	12	14	16	18
	T [mm]	—	—	—	—	—	68	75
	L [mm]	80	80	80	80	80	80	80
Length A [mm]	oversize	160	160	160	160	160	160	160
Order No.	A63/80.182...	.03.8	.04.8	.05.8	.06.8	.08.8	.10.8	.12.8



- Mini Shrink shrink and cooling sleeve**
- Protect Mini Shrink chucks from overheating
 - Extend lifetime of shrink fit chucks
 - Secure and user friendly handling
 - Cooling with standard cooling body

Fitting sleeves for Mini Shrink chucks						Order No.
Size [mm]		Ø 03	Ø 06	Ø 08	Ø 10	Ø 12
Size [inch]		Ø 1/8"	Ø 1/4"	Ø 5/16"	Ø 3/8"	Ø 1/2"
Order No.	80.105.14.2...	.04	.09	.10	.11	.12
Base						80.105.14.2.99
Set with base (12 pcs)						80.105.14.2.00

DIN 69893 HSK

POWER COLLET CHUCK HSK A63/80 (TAPER 63 mm/FLANGE 80 mm)

CERTIFICATE OF QUALITY	
<input checked="" type="checkbox"/>	Chuck body fine balanced G2.5 33,000 rpm or U<1 gmm
<input checked="" type="checkbox"/>	All functional surfaces fine machined
<input checked="" type="checkbox"/>	More accurate than DIN

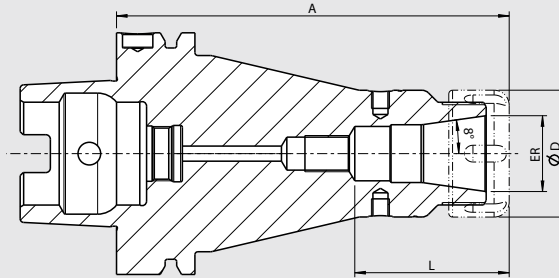

The Power Collet Chuck is designed for the highest machining capacity in high-speed manufacturing. The optimized design with improved construction combines high rigidity with vibration dampening features, giving more protection to the machine, spindle and tool. The universal Power Collet Chuck is a unique high performance chuck that can also be used with standard collets.

- High runout accuracy: < 0.00012" (3µm) at 3×D with HAIMER Power Collets
- Also for standard collets ER according to ISO 15488 (Attention: By using standard collet ER length A will increase)
- High rigidity
- Runs smoother thanks to vibration absorbing geometry, yielding better surface finish and increased tool, spindle and machine protection
- Highest cutting performance with higher spindle speeds, higher feeds and larger cutting depths
- Shorter cycle times, higher machining accuracy, high clamping force
- Equally suited to high-speed manufacturing and heavy milling
- With threaded holes for balancing screws
- Optional: Cool-Jet bores on Power Collets from ER 25, Ø 6 mm
- Program of Power Collets on pages 154 - 157

INCH	ER	16	25	32
	Ø D [inch]	1.10	1.65	1.97
	Clamping range [inch]	1/8-3/8	1/8-5/8	1/8-3/4
	L [inch]	1.69	1.97	1.87
Length A [inch]	ultra short	2.95	2.95	2.95
Order No.	A63/80.025...	.16.3	.25.3	.32.3
Length A [inch]	ZG130	5.12	5.12	5.12
Order No.	A63/80.024...	.16.3	.25.3	.32.3

METRIC	ER	16	25	32
	Ø D [mm]	28	42	50
	Clamping range [mm]	2.0-10.0	2.0-16.0	2.0-20.0
	L [mm]	43	50	47.5
Length A [mm]	ultra short	75	75	75
Order No.	A63/80.025...	.16.3	.25.3	.32.3
Length A [mm]	ZG130	130	130	130
Order No.	A63/80.024...	.16.3	.25.3	.32.3

Accessories

Locknut (fine-balanced)

Size	ER 16	ER 25	ER 32
Order No. 83.914...	.16	.25	.32

Clamping wrench

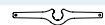

Torque wrench for Power Collet Chucks

Order No. 84.600.00



Power Collets

Power Collets with Safe-Lock™

Cool-Jet bores for Power Collets

Order No. 91.100.27

FACE MILL ARBOR
 HSK A63/80 (TAPER 63 mm/FLANGE 80 mm)

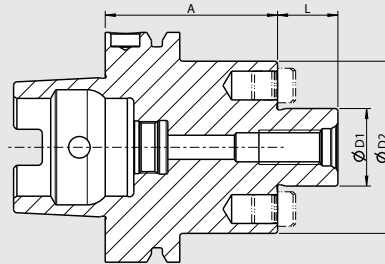

CERTIFICATE OF QUALITY	
<input checked="" type="checkbox"/>	Chuck body fine balanced G2.5 33,000 rpm or U < 1 gmm
<input checked="" type="checkbox"/>	All functional surfaces fine machined
<input checked="" type="checkbox"/>	More accurate than DIN

Use:

For holding face mill cutters and cutters with radial driving slot DIN 1880 and exceeding clamping diameter 40 clamping according to DIN 2079 is possible, too (4 additional tapping holes).

DIN 69882-3

- Included in delivery: tightening bolt, without coolant tube
- With coolant exit bores on the end face for milling cutters with central cooling

INCH	Clamping Ø D1 [inch]	3/4	1
	Ø D2 [inch]	1.71	2.17
	L [inch]	0.67	0.67
Length A [inch]	short	1.97	2.36
Order No.	A63/80.050... 	.3/4z.i	.1z.i

METRIC	Clamping Ø D1 [mm]	22	27
	Ø D2 [mm]	48	60
	L [mm]	19	21
Length A [mm]	short	50	60
Order No.	A63/80.050... 	.22	.27

Accessories

Tightening bolt

Size D1		22	27
Order No.	85.300... 	.22	.27

Wrench

Size D1		22	27
Order No.	84.400... 	.22	.27

Balancing index rings

Size D1		22	27
Order No.	79.350... 	.50	.60

SHRINK FIT CHUCK HSK-A 80 · DIN 69893-1

CERTIFICATE OF QUALITY

- Chuck body fine balanced
G2.5 25,000 rpm
or U<1gmm
- All functional surfaces machined
- More accurate than DIN

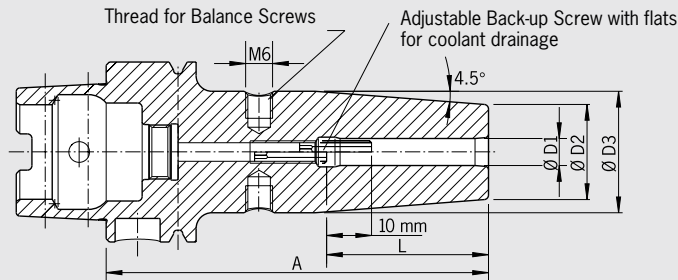

Use:

Shrink fit chuck suitable for use with all available shrink fit units.

- Heat resistant hot-working steel
- Hardened 54-2 HRC
- For HSS and solid carbide tools
- Shank tolerance h6
- With threaded holes for balancing screws

Optional:

- Cooling with Cool-Jet for an extra charge (See page 180)
- Cooling with Cool Flash for an extra charge (See pp. 182/183)

Standard version, similar to DIN 69882-8

Clamping	Ø D1 [mm]	03	04	05	06	08	10	12	14	16	18	20	25	32
Ø D2 [mm]		10	10	10	21	21	24	24	27	27	33	33	44	44
Ø D3 [mm]		—	—	—	27	27	32	32	34	34	42	42	53	53
L [mm]		—	—	—	36	36	42	47	47	50	50	52	58	58
Gage Length A [mm]	short	—	—	—	85	85	90	95	95	100	100	105	115	120
Order No.	A80.140...				.06	.08	.10	.12	.14	.16	.18	.20	.25	.32



Accessories

Shrink fit extensions		
Balance screws		
Coolant tube		Order No. 85.700.80
Reduction sleeves		
Back-up screws		
Cool-Jet bores		Order No. 91.100.24 See page 180
Cool Flash		Order No. 91.100.40 See pages 182/183

POWER SHRINK CHUCK
HSK-A 80 · DIN 69893-1

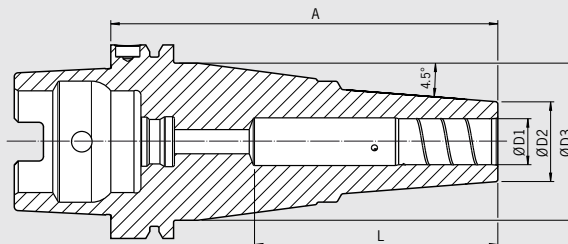

CERTIFICATE OF QUALITY	
<input checked="" type="checkbox"/>	Chuck body fine balanced G2.5 25,000 1/min or U<1 gmm
<input checked="" type="checkbox"/>	All functional surfaces fine machined
<input checked="" type="checkbox"/>	More accurate than DIN
<input checked="" type="checkbox"/>	Cool-Jet, can be sealed

The Power Shrink Chuck is designed for the highest cutting performance in high-speed manufacturing. The optimized design combines high rigidity with vibration dampening, which protects the machine, spindle and tool.

- Highest cutting performance with higher spindle speeds, higher feeds and larger cutting depths
- Shorter cycle times
- Quieter running, therefore better surface quality and protection of tools, spindles and machines
- Higher machining accuracy
- With threaded holes for balancing screws
- Cool-Jet coolant bores that can be sealed included

The long versions with slim tips are especially versatile to use.

- High rigidity
- Slim at the tip
- Dampen vibrations
- Higher clamping forces
- Equally suited to high-speed manufacturing and heavy milling
- Universal usage, saves space in tool magazine

Optional:

- Cooling with Cool Flash from for an extra charge (See pp. 182/183)
- Safe-Lock™ Pull out protection (See pages 184–187)

INCH	Clamping Ø D1 [inch]		1/2"	3/4"
	Ø D2 [inch]		0.944	1.299
	Ø D3 [inch] short		2.598	2.598
	Ø D3 [inch] ZG130/oversize		2.559	2.559
	L [inch] short		2.795	2.716
	L [inch] ZG130		2.952	3.779
	L [inch] oversize		2.952	3.976
Gage length A [inch]	short		3.94	3.94
Order No.	A80.149...		.1/2z.3.2140	.3/4z.3.2140
Gage length A [inch]	ZG130		5.12	5.12
Order No.	A80.149...		.1/2z.3.2144	.3/4z.3.2144
Gage length A [inch]	oversize		6.3	6.3
Order No.	A80.149...		.1/2z.3.2142	.3/4z.3.2142

METRIC	Clamping Ø D1 [mm]		08	10	12	16	20
	Ø D2 [mm]		21	24	24	27	33
	Ø D3 [mm] short		66	66	66	66	66
	Ø D3 [mm] ZG130/oversize		65	65	65	65	65
	L [mm] short		—	68	71	70	69
	L [mm] ZG130		—	70	75	75	96
	L [mm] oversize		—	70	75	75	101
Gage length A [mm]	short		100	100	100	100	100
Order No.	A80.149...		.08.3.2140	.10.3.2140	.12.3.2140	.16.3.2140	.20.3.2140
Gage length A [mm]	ZG130		130	130	130	130	130
Order No.	A80.149...		.08.3.2144	.10.3.2144	.12.3.2144	.16.3.2144	.20.3.2144
Gage length A [mm]	oversize		160	160	160	160	160
Order No.	A80.149...		.08.3.2142	.10.3.2142	.12.3.2142	.16.3.2142	.20.3.2142

Accessories
Cool Flash

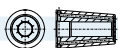

Order No. 91.100.40

See pages 182/183

ER COLLET CHUCK HSK-A 80 · DIN 69893-1

CERTIFICATE OF QUALITY

- ☑ Chuck body fine balanced
G2.5 25,000 rpm
or U<1gmm
- ☑ All functional surfaces machined
- ☑ More accurate than DIN

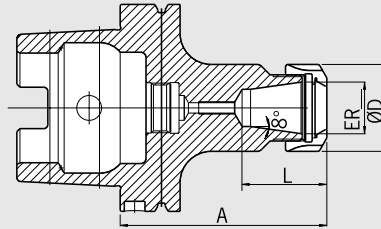

Use:

For clamping tools with cylindrical shank in ER collets according to ISO 15488.

- Included in delivery: locknut (balanced, with slide coating for higher clamping forces); without coolant tube
- Locknut type HS (High-Speed, fine balanced, with slide coating for higher clamping forces) for an extra charge
- Increasing size L possible upon request

INCH	Ø ER	ER16	ER25	ER32
	Ø D [inch]	1.1	1.65	1.97
	Clamping range [inch]	0.02–0.39	0.04–0.63	0.59–0.79
	L [inch]	1.26	1.62	1.85
Gage length A [inch]	short	3.94	3.94	3.94
Order No.	A80.020...	.16	.25	.32

Accessories

See accessories (pg. 143)

Spare parts Collet nut HS (Highspeed), fine-balanced

Ø ER	ER16	ER25	ER32
Order No. 83.912...	.16.HS	.25.HS	.32.HS

Spare parts Wrench

Ø ER	ER16	ER25	ER32
Order No. 84.200...	.16	-	-

Spare parts Wrench

Ø ER	ER16	ER25	ER32
Order No. 84.200...	-	.25	.32

Spare parts Balancing index rings

Ø ER	ER16	ER25	ER32
Order No. 79.350...	.28	.42	.48

Spare parts Collet

Ø ER	ER16	ER25	ER32
See accessories			

Spare parts Adjusting Screw

Ø ER	ER16	ER25	ER32
Order No. 85.800...	.34	.34	.35

Spare parts Coolant Tube

Ø ER	ER16	ER25	ER32
Order No. 85.700...	.80		

POWER COLLET CHUCK
HSK-A 80 · DIN 69893-1

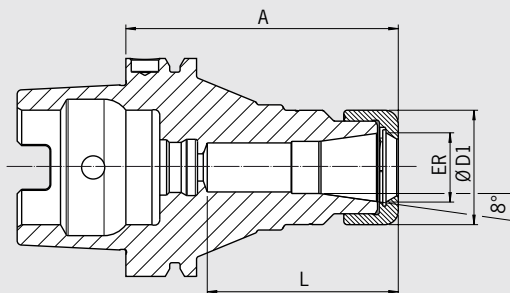

CERTIFICATE OF QUALITY	
<input checked="" type="checkbox"/>	Chuck fine balanced G2.5 25,000 1/min or U < 1 gmm
<input checked="" type="checkbox"/>	All functional surfaces fine machined
<input checked="" type="checkbox"/>	More accurate than DIN

The Power Collet Chuck is designed for the highest machining capacity in high-speed manufacturing. The optimized design with improved construction combines high rigidity with vibration dampening features, giving more protection to the machine, spindle and tool.

The universal Power Collet Chuck is a unique high performance chuck that can also be used with standard collets.

- High runout accuracy: < 0.00012" (3µm) at 3 × D with HAIMER Power Collets
- Also for standard collets ER according to ISO 15488 (formerly DIN 6499) (Attention: By using standard collet ER length A will increase)
- High rigidity

- Runs smoother thanks to vibration absorbing geometry, yielding better surface finish and increased tool, spindle and machine protection
- Highest cutting performance with higher spindle speeds, higher feeds and larger cutting depths
- Shorter cycle times, higher machining accuracy, higher clamping forces
- Equally suited to high-speed manufacturing and heavy milling
- With threaded holes for balancing screws
- Optional: Cool-Jet bores on Power Collets from ER 25 Ø 1/4"
- Program of Power Collets on pages 154 – 157

INCH	ER		25	32
	Ø D1 [inch]		1.653	1.968
	Clamping range [inch]		1/8"-5/8"	1/8"-3/4"
	L [inch] short		2.755	2.716
	L [inch] ZG130		3.248	3.543
	L [inch] oversize		3.248	3.858
Gage length A [inch]	short		3.94	3.94
Order No.	A80.029...		.25.3.2021	.32.3.2021
Gage length A [inch]	ZG130		5.12	5.12
Order No.	A80.029...		.25.3.2024	.32.3.2024
Gage length A [inch]	oversize		6.3	6.3
Order No.	A80.029...		.25.3.2022	.32.3.2022

Accessories

Locknut (fine-balanced)

Size	ER 25	ER 32
Order No.	83.914...	.25 .32

Torque wrench for Power Collet Chucks

Order No.	84.600.00
-----------	-----------

Torque wrench inserts

Size	ER 25	ER 32
------	-------	-------

Cool-Jet bores for Power Collets

Order No.	91.100.27
-----------	-----------

SHRINK FIT CHUCK HSK-A 100 · DIN 69893-1

CERTIFICATE OF QUALITY	
<input checked="" type="checkbox"/>	Chuck body fine balanced G2.5 25,000 rpm or U<1gmm
<input checked="" type="checkbox"/>	All functional surfaces machined
<input checked="" type="checkbox"/>	More accurate than DIN

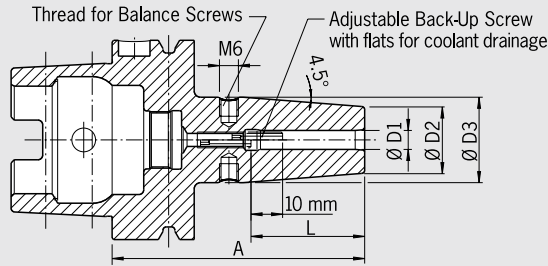

Use:

Shrink fit chuck suitable for use with all available shrink fit units.

- Heat resistant hot-working steel
- Hardened 54-2 HRC
- For HSS and solid carbide tools
- Shank tolerance h6

- With threaded holes for balancing screws
- Inch sizes with Cool-Jet, metric sizes with Cool-Jet optional
- Included in delivery: Backup screw, without coolant tube

Optional:

- Cooling with Cool Flash for an extra charge (See pp. 182/183)

INCH	Clamping Ø D1 [inch]		1/4"	5/16"	3/8"	7/16"	1/2"	5/8"	3/4"	1"	1 1/4"
	Ø D2 [inch]		0.83	0.83	0.94	0.94	0.94	1.06	1.30	1.73	1.73
	Ø D3 [inch]		1.06	1.06	1.26	1.26	1.26	1.34	1.65	2.09	2.09
	L [inch]		1.42	1.42	1.65	1.65	1.85	1.97	2.05	2.28	2.28
Gage length A [inch]	short		3.35	3.35	3.54	3.54	3.74	3.94	4.13	4.53	4.72
Order No.	A10.140...		.1/4Z.4	.5/16Z.4	.3/8Z.4	.7/16z.4	.1/2Z.4	.5/8Z.4	.3/4Z.4	.1Z.4	.1 1/4Z.4
Gage length A [inch]	ZG130		5.12	5.12	5.12	5.12	5.12	5.12	5.12	5.12	5.12
Order No.	A10.144...		.1/4Z.4	.5/16Z.4	.3/8Z.4	.7/16z.4	.1/2Z.4	.5/8Z.4	.3/4Z.4	.1Z.4	.1 1/4Z.4
Gage length A [inch]	oversize		6.30	6.30	6.30	6.30	6.30	6.30	6.30	6.30	6.30
Order No.	A10.142...		.1/4Z.4	.5/16Z.4	.3/8Z.4	.7/16z.4	.1/2Z.4	.5/8Z.4	.3/4Z.4	.1Z.4	.1 1/4Z.4
Gage length A [inch]	ZG200		7.87	—	7.87	—	7.87	7.87	7.87	7.87	—
Order No.	A10.146...		.1/4Z.4	—	.3/8Z.4	—	.1/2Z.4	.5/8Z.4	.3/4Z.4	.1Z.4	—

Standard version, similar to DIN 69882-8

METRIC	Clamping Ø D1 [mm]		06	08	10	12	14	16	18	20	25	32
	Ø D2 [mm]		21	21	24	24	27	27	33	33	44	44
	Ø D3 [mm]		27	27	32	32	34	34	42	42	53	53
	L [mm]		36	36	42	47	47	50	50	52	58	58
Gage length A [mm]	short		85	85	90	95	95	100	100	105	115	120
Order No.	A10.140...		.06	.08	.10	.12	.14	.16	.18	.20	.25	.32
Gage length A [mm]	ZG130		130	130	130	130	130	130	130	130	130	130
Order No.	A10.144...		.06	.08	.10	.12	.14	.16	.18	.20	.25	.32
Gage length A [mm]	oversize		160	160	160	160	160	160	160	160	160	160
Order No.	A10.142...		.06	.08	.10	.12	.14	.16	.18	.20	.25	.32
Gage length A [mm]	ZG200		200	200	200	200	200	200	200	200	200	200
Order No.	A10.146...		.06	.08	.10	.12	.14	.16	.18	.20	.25	.32

Accessories

See accessories (pg. 143)

Spare parts Coolant Tube

Order No. 85.700.10



Spare parts Reduction Sleeves for small shanks

See accessories



Spare parts Set of Balance Screws

See accessories



Spare parts Back up screws

See accessories



Cool Flash



Order No. 91.100.40

See pages 182/183

POWER SHRINK CHUCK
HSK-A 100 · DIN 69893-1



CERTIFICATE OF QUALITY

- Chuck body fine balanced
G2.5 25,000 rpm
or U < 1 gmm
- All functional surfaces machined
- More accurate than DIN
- Cool-Jet, can be sealed

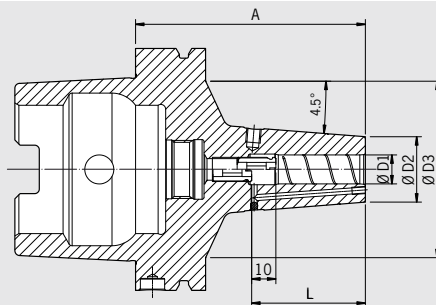

The Power Shrink Chuck is designed for the highest cutting performance in high-speed manufacturing. The optimized design combines high rigidity with vibration dampening, which protects the machine, spindle and tool.

- Highest cutting performance with higher spindle speeds, higher feeds and larger cutting depths
- Shorter cycle times
- Quieter running, therefore better surface quality and protection of tools, spindles and machines
- Higher machining accuracy
- With threaded holes for balancing screws
- Cool-Jet coolant bores that can be sealed included

The long versions (A=160 and 200) with slim tips are especially versatile to use.

- High rigidity
- Slim at the tip
- Dampen vibrations
- Higher clamping forces
- Equally suited to high-speed manufacturing and heavy milling
- Universal usage, saves space in tool magazine

Optional:

- Cooling with Cool Flash from for an extra charge (See pp. 182/183)
- Safe-Lock™ Pull out protection (See pages 184-187)

INCH	Clamping Ø D1 [inch]		1/4"	5/16"	3/8"	1/2"	5/8"	3/4"	1"
	Ø D2 [inch]		0.83	0.83	1.06	1.06	1.3	1.73	1.73
	Ø D3 [inch] ultra short		2.36	2.36	2.09	2.87	3.07	3.35	3.35
	Ø D3 [inch]		3.27	3.27	3.27	3.27	3.27	3.27	3.27
	L [inch]		1.42	1.42	1.65	1.85	1.97	2.05	2.28
Gage length A [inch]	short		3.35	3.35	3.54	3.74	3.94	4.13	4.53
Standard Order No.	A10.140...		.1/4z.3	.5/16z.3	.3/8z.3	.1/2z.3	.5/8z.3	.3/4z.3	.1z.3
Safe-Lock™ Order No.	A10.140...		.1/4z.37	.5/16z.37	.3/8z.37	.1/2z.37	.5/8z.37	.3/4z.37	.1z.37
Gage length A [inch]	oversize		6.30	6.30	6.30	6.30	6.30	6.30	6.30
Standard Order No.	A10.142...		.1/4z.3	.5/16z.3	.3/8z.3	.1/2z.3	.5/8z.3	.3/4z.3	.1z.3
Safe-Lock™ Order No.	A10.142...		.1/4z.37	.5/16z.37	.3/8z.37	.1/2z.37	.5/8z.37	.3/4z.37	.1z.37
Gage length A [inch]	ZG200		7.87	7.87	7.87	7.87	7.87	7.87	7.87
Standard Order No.	A10.146...		.1/4z.3	.5/16z.3	.3/8z.3	.1/2z.3	.5/8z.3	.3/4z.3	.1z.3
Safe-Lock™ Order No.	A10.146...		.1/4z.37	.5/16z.37	.3/8z.37	.1/2z.37	.5/8z.37	.3/4z.37	.1z.37

METRIC	Clamping Ø D1 [mm]		06	08	10	12	14	16	18	20	25
	Ø D2 [mm]		21	21	27	27	33	33	44	44	44
	Ø D3 [mm] ultra short		60	60	53	73	60	78	76	85	85
	Ø D3 [mm]		83	83	83	83	83	83	83	83	83
	L [mm]		36	36	42	47	47	50	50	52	58
Gage length A [mm]	short		85	85	90	95	95	100	100	105	115
Standard Order No.	A10.140...		.06.3	.08.3	.10.3	.12.3	.14.3	.16.3	.18.3	.20.3	.25.3
Safe-Lock™ Order No.	A10.140...		.06.37	.08.37	.10.37	.12.37	.14.37	.16.37	.18.37	.20.37	.25.37
Gage length A [mm]	oversize		160	160	160	160	160	160	160	160	160
Standard Order No.	A10.142...		.06.3	.08.3	.10.3	.12.3	.14.3	.16.3	.18.3	.20.3	.25.3
Safe-Lock™ Order No.	A10.142...		.06.37	.08.37	.10.37	.12.37	.14.37	.16.37	.18.37	.20.37	.25.37
Gage length A [mm]	ZG200		200	200	200	200	200	200	200	200	200
Standard Order No.	A10.146...		.06.3	.08.3	.10.3	.12.3	.14.3	.16.3	.18.3	.20.3	.25.3
Safe-Lock™ Order No.	A10.146...		.06.37	.08.37	.10.37	.12.37	.14.37	.16.37	.18.37	.20.37	.25.37

Accessories

Cool Flash



Order No. 91.100.40

See pages 182/183

HEAVY DUTY CHUCK HSK-A100 · DIN 69893-1

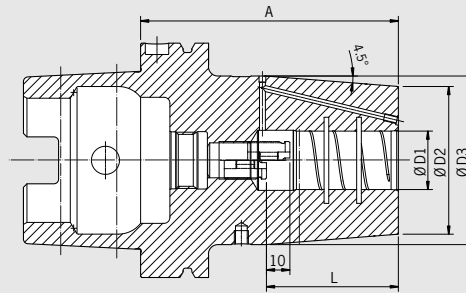

CERTIFICATE OF QUALITY	
<input checked="" type="checkbox"/>	Chuck body fine balanced G2.5 25,000 rpm or U<1 gmm
<input checked="" type="checkbox"/>	All functional surfaces fine machined
<input checked="" type="checkbox"/>	More accurate than DIN
<input checked="" type="checkbox"/>	Cool-Jet, can be sealed

Finally there is a holder for heavy machining that can replace the Weldon tool holder. The Heavy Duty Chuck is a shrink fit chuck designed for extreme cases. The contour is optimized for highest rigidity and clamping force.

- Smooth clamping of the tool shank
- TIR less than 0.00012" (3 µm)
- Reinforced outer contour

- To shrink with 13 kW HD-Coil or with high performance shrink fit unit HAIMER Power Clamp Profi Plus (20 kW)
- With internal groove in the clamping bore
- With threaded holes for balancing screws
- Cool-Jet coolant bores that can be sealed included

Optional:

- Cooling with Cool Flash from 5/8" – 1" for an extra charge (See pp. 182/183)
- Safe-Lock™ Pull out protection (See pages 184–187)

INCH	Clamping Ø D1 [inch]	5/8"	3/4"	1"	1 1/4"	1 1/2"	2"
	Ø D2 [inch]	2.01	2.28	2.48	2.76	3.22	3.22
	Ø D3 [inch]	—	2.64	2.83	3.07	3.70	3.70
	L [inch]	1.97	2.05	2.28	2.4	3.46	3.46
Gage length A [inch]	short	3.94	3.94	4.33	4.33	5.51	5.51
Order No.	A10.150...	.5/8z.6	.3/4z.6	.1z.6	.11/4z.6	.11/2z.6	.2z.6
Safe-Lock™ Order No.	A10.150...	.5/8z.67	.3/4z.67	.1z.67	.11/4z.67	.11/2z.67	.2z.67

METRIC	Clamping Ø D1 [mm]	16	20	25	32	40	50
	Ø D2 [mm]	51	58	63	70	82	82
	Ø D3 [mm] short	—	67	72	78	94	94
	Ø D3 [mm]	85	85	85	85	94	94
	L [mm]	50	52	58	61	88	88
Gage length A [mm]	short	100	100	110	110	140	140
Order No.	A10.150...	.16.6	.20.6	.25.6	.32.6	.40.6	.50.6
Safe-Lock™ Order No.	A10.150...	.16.67	.20.67	.25.67	.32.67	.40.67	.50.67
Gage length A [mm]	oversize	160	160	160	160	160	160
Order No.	A10.152...	.16.6	.20.6	.25.6	.32.6	.40.6	.50.6
Safe-Lock™ Order No.	A10.152...	.16.67	.20.67	.25.67	.32.67	.40.67	.50.67
Gage length A [mm]	ZG200	200	200	200	200	200	200
Order No.	A10.156...	.16.6	.20.6	.25.6	.32.6	.40.6	.50.6
Safe-Lock™ Order No.	A10.156...	.16.67	.20.67	.25.67	.32.67	.40.67	.50.67

Heavy Duty Chuck – For 13 kW shrink fit machine

Clamping	Ø D1 [mm]	16	20
	Ø D2 [mm]	46	46
	L [mm]	51	53
Gage length A [mm]	short	100	100
Order No.	A10.140...	.16.6	.20.6 ¹⁾
Safe-Lock™ Order No.	A10.140...	.16.67	.20.67 ¹⁾

Accessories

Cool Flash



Order No. 91.100.40

See pages 182/183

1) Without back-up screw

Technical data and availability subject to change without prior notice

POWER COLLET CHUCK
HSK-A100 · DIN 69893-1



CERTIFICATE OF QUALITY

- Chuck body fine balanced
 G2.5 25,000 rpm
 or U < 1 gmm
- All functional surfaces fine machined
- More accurate than DIN

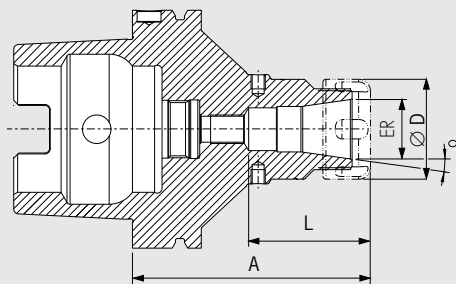





The Power Collet Chuck is designed for the highest machining capacity in high-speed manufacturing. The optimized design with improved construction combines high rigidity with vibration dampening features, giving more protection to the machine, spindle and tool.

The universal Power Collet Chuck is a unique high performance chuck that can also be used with standard collets.

- High runout accuracy: < 0.00012" (3µm) at 3 × D with HAIMER Power Collets
- Also for standard collets ER according to ISO 15488 (formerly DIN 6499)
 (Attention: By using standard collet ER length A will increase)
- High rigidity

- Runs smoother thanks to vibration absorbing geometry, yielding better surface finish and increased tool, spindle and machine protection
- Highest cutting performance with higher spindle speeds, higher feeds and larger cutting depths
- Shorter cycle times, higher machining accuracy, higher clamping forces
- Equally suited to high-speed manufacturing and heavy milling
- With threaded holes for balancing screws
- Optional: Cool-Jet bores on Power Collets from ER 25 Ø 1/4"
- Program of Power Collets on pages 154 – 157

INCH	ER		16	25	32
	Ø D [inch]		1.1	1.65	1.97
	Clamping range [inch]		1/8"-3/8"	1/8"-5/8"	1/8"-3/4"
	L [inch]		1.69	2.01	2.09
Gage length A [inch]	ultra short		3.35	3.35	3.35
Order No.	A10.025...		.16.3	.25.3	.32.3
Gage length A [inch]	short		3.93	3.93	3.93
Order No.	A10.020...		.16.3	.25.3	.32.3
Gage length A [inch]	ZG130		5.12	5.12	5.12
Order No.	A10.024...		.16.3	.25.3	.32.3
Gage length A [inch]	oversize		6.30	6.30	6.30
Order No.	A10.022...		.16.3	.25.3	.32.3

Accessories

Locknut (fine-balanced)

Size		ER 16	ER 25	ER 32	
Order No. 83.914...		.16	.25	.32	
Clamping wrench					See page 158

Torque Master torque wrench for Power Collet Chucks

Order No. 84.600.00  See page 158

Power Collets See page 154

Power Collets with Safe-Lock™ See page 156

Cool-Jet bores for Power Collets Order No. 91.100.27 See page 157

ER COLLET CHUCK
HSK-A 100 · DIN 69893-1

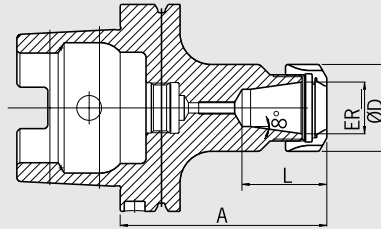

CERTIFICATE OF QUALITY

- Chuck body fine balanced
G2.5 25,000 rpm
or U<1gmm
- All functional surfaces machined
- More accurate than DIN

Use:

For clamping tools with cylindrical shank in ER collets.

- Included in delivery: locknut (balanced, with slide coating for higher clamping forces); without coolant tube
- Locknut type HS (High-Speed, fine balanced, with slide coating for higher clamping forces) for an extra charge
- Increasing size L possible upon request

INCH	ER	ER16	ER25	ER32	ER40
	ØD [inch]	1.1	1.65	1.97	2.48
	Clamping range [inch]	0.02–0.39	0.04–0.63	0.59–0.79	0.98–1.02
	L [inch]	1.28	1.62	1.85	2.09
Gage length A [inch]	short	3.94	3.94	3.94	4.72
Order No.	A10.020...	.16	.25	.32	.40
Gage length A [inch]	oversize	6.30	6.30	6.30	6.30
Order No.	A10.022...	.16	.25	.32	.40

Accessories

See accessories (pg. 143)

Spare parts Collet nut HS (Highspeed), fine-balanced					
ØER		ER16	ER25	ER32	ER40
Order No.	83.912...	.16.HS	.25.HS	.32.HS	.40.HS
Spare parts Wrench					
ØER		ER16	-	-	-
Order No.	84.200...	.16			
Spare parts Wrench					
ØER		-	ER25	ER32	ER40
Order No.	84.200...		.25	.32	.40
Spare parts Balancing index rings					
ØER		ER16	ER25	ER32	ER40
Order No.	79.350...	.28	.42	.48	.60
Spare parts Collet					
ØER					
See accessories					
Spare parts Adjusting Screw					
ØER		ER16	ER25	ER32	ER40
Order No.	85.800...	.34	.34	.35	.35
Spare parts Coolant Tube					
ØER					
Order No.	85.700...	.10			

HG COLLET CHUCK
 HSK-A 100 · DIN 69893-1

CERTIFICATE OF QUALITY

- Chuck body fine balanced
 G2.5 25,000rpm
 or U<1gmm
- All functional surfaces machined
- More accurate than DIN

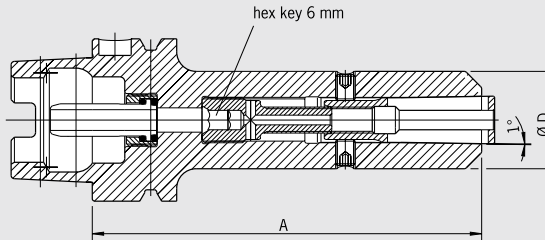



Use:

For high-precise clamping of tools with cylindrical shank, also with clamping flats. Very useful for high-speed machining.

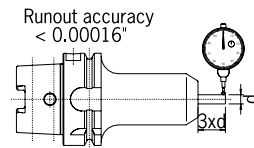
- Included in delivery: high-precision chuck with clamping screw and pull-out hook, without collet, without coolant tube
- Shank tolerance h6
- Optional: Cool-Jet bores on HG Collets from diam. 0.25" – 0.78"
- Extensions for High-Precision Chuck available



INCH	HG		01	02	03
	ØD [inch]		1.18	1.38	1.89
	Clamping Ø [inch] shank tolerance h6		0.08–0.35	0.39–0.57	0.63–0.79
Gage length A [inch]	short		4.72	4.72	5.12
Order No.	A10.120...		.01	.02	.03
Gage length A [inch]	oversize		6.30	6.30	6.30
Order No.	A10.122...		.01	.02	.03

Accessories

See accessories (pg. 143)

Spare parts Collet

HG
 See accessories 

Spare parts Locking Screw

HG short  HG 01 HG 02 HG 03
Order No. **82.560...** **.02** **.14** **.14**

HG oversize  HG 01 HG 02 HG 03
Order No. **82.560...** **.04** **.05** **.05**

Spare parts Balancing index rings

HG  HG 01 HG 02 HG 03
Order No. **79.350...** **.30** **.35** **.48**

Spare parts Coolant Tube

HG  HG 01 HG 02 HG 03
Order No. **85.700...** **.10** **.10** **.10**

FACE MILL ARBOR
HSK-A 100 · DIN 69893-1

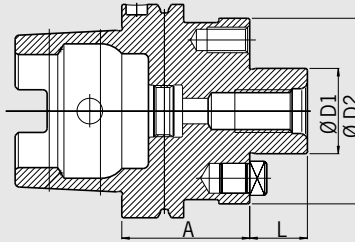

CERTIFICATE OF QUALITY	
<input checked="" type="checkbox"/>	Chuck body fine balanced G2.5 25,000 rpm or U<1gmm
<input checked="" type="checkbox"/>	All functional surfaces machined
<input checked="" type="checkbox"/>	More accurate than DIN

Use:

For clamping face-mill cutters.

With coolant exit bores on the end face for milling cutters with central cooling.

- Included in delivery: Face Mill Arbor with clamping screw
- Inch sizes: Coolant bores on front side for an extra charge

INCH		Ø D1 [inch]	3/4"	1"	1 1/4"	1 1/2"
		L [inch]	0.67	0.67	0.67	0.94
		Ø D2 [inch]	1.71	2.17	2.75	3.78
Gage length A [inch]	long		3.94	3.94	3.94	3.94
Order No.	A10.051...		.3/4Z	.1Z	.1 1/4Z	.1 1/2Z
Gage length A [inch]	oversize		6.30	6.30	6.30	6.30
Order No.	A10.052...		.3/4Z	.1Z	.1 1/4Z	.1 1/2Z

METRIC		Ø D1 [mm]	16	22	27	32	40
		L [mm]	17	19	21	24	27
		Ø D2 [mm]	36	48	60	78	87
Gage length A [mm]	short		50	50	50	50	60
Order No.	A10.050...		.16.KKB	.22.KKB	.27.KKB	.32.KKB	.40.KKB
Gage length A [mm]	long		100	100	100	100	100
Order No.	A10.051...		.16.KKB	.22.KKB	.27.KKB	.32.KKB	.40.KKB
Gage length A [mm]	oversize		160	160	160	160	160
Order No.	A10.052...		.16.KKB	.22.KKB	.27.KKB	.32.KKB	.40.KKB

Accessories

Spare parts Clamping Screw

Ø D1 [inch]	3/4"	1"	1 1/4"	1 1/2"		
Order No.	85.300...		.3/4Z	.1Z	.11/4Z	.11/2Z

Spare parts Wrench

Ø D1 [inch]	3/4"	1"	1 1/4"	1 1/2"		
Order No.	84.400...		.3/4Z	.1Z	.11/4Z	.11/2Z

Spare parts Balancing index ring

Ø D1 [inch]	3/4"	1"	-	-	
Order No.	79.350...		.1.71Z	.55	

Spare parts Coolant Tube

Ø D1 [inch]	3/4"	1"	1 1/4"	1 1/2"		
Order No.	85.700...		.10	.10	.10	.10

Coolant bores

Order No.	91.100.03	
------------------	------------------	--

Accessories

Spare parts Clamping Screw

Ø D1 [mm]	16	22	27	32	40		
Order No.	85.300...		.16	.22	.27	.32	.40

Spare parts Wrench

Ø D1 [mm]	16	22	27	32	40		
Order No.	84.400...		.16	.22	.27	.32	.40

Spare parts Balancing index ring

Ø D1 [mm]	16	22	27	32	40		
Order No.	79.350...		.36	.48	.60	.78	.87

Spare parts Coolant Tube

Ø D1 [mm]	16	22	27	32	40		
Order No.	85.700...		.10	.10	.10	.10	.10

ADAPTER FOR MORSE TAPER WITH TANG
 HSK-A 100 · DIN 69893-1

CERTIFICATE OF QUALITY

- Chuck balanced
G6.3 8.000 rpm
- All functional surfaces fine machined
- More accurate than DIN

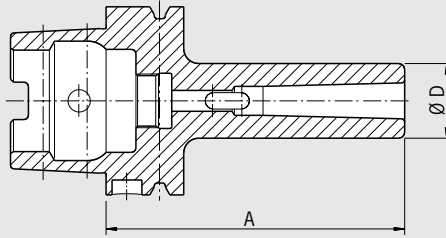

Use:

For holding tools with morse taper and tang according to DIN 228-1 form B.

– Fine-balancing for an extra charge

MK		01	02	03	04	
	Ø D [mm]	25	32	40	48	
	Gage Length A [mm]	110	120	150	170	
	Order No.	A10.080...	.01	.02	.03	.04



Accessories

Balancing index rings

MK		01	02	03	04
Order No.	79.350...	.25	.32	.40	.48



Coolant tube

Order No.	85.700.10
-----------	-----------



ADAPTER FOR MORSE TAPER WITH THREAD HSK-A 100 · DIN 69893-1

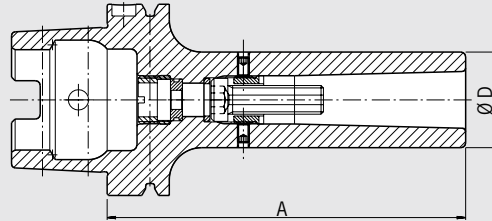

CERTIFICATE OF QUALITY	
<input checked="" type="checkbox"/>	Chuck balanced G6.3 8.000 rpm
<input checked="" type="checkbox"/>	All functional surfaces fine machined
<input checked="" type="checkbox"/>	More accurate than DIN

Use:

For holding tools with morse taper with thread according to DIN 228-1 form A.



- Fine-balancing for an extra charge
- Delivery with tightening bolt without coolant tube

MK			01	02	03	04
	Ø D [mm]		25	32	40	48
	Gage Length A [mm]	short	110	120	150	170
	Order No.	A10.130...	.01	.02	.03	.04



Accessories

Balancing index rings

MK			01	02	03	04
Order No.	79.350...		.25	.32	.40	.48
Coolant tube						
Order No.	85.700.10					

BLANK ADAPTER
HSK-A 100 · DIN 69893-1

CERTIFICATE OF QUALITY

- All functional surfaces fine machined
- More accurate than DIN

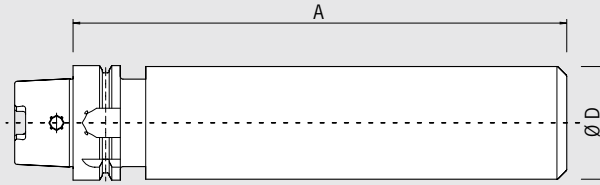

Use:

For manufacturing special tools in your own factory.

Design:

HSK is hardened and ground, the cylindrical part is soft.

	Ø D [mm]		83
Gage Length A [mm]	ZG250		250
Order No.	A10.090...		.83

DIN 69893 HSK

POWER SHRINK CHUCK HSK-A 125 · DIN 69893-1



CERTIFICATE OF QUALITY	
<input checked="" type="checkbox"/>	Chuck body fine balanced G2.5 25,000 rpm or U<1 gmm
<input checked="" type="checkbox"/>	All functional surfaces fine machined
<input checked="" type="checkbox"/>	More accurate than DIN
<input checked="" type="checkbox"/>	Cool-Jet, can be sealed

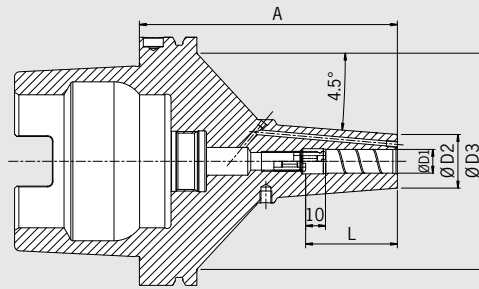

The Power Shrink Chuck is designed for the highest cutting performance in high-speed manufacturing. The optimized design combines high rigidity with vibration dampening, which protects the machine, spindle and tool.

- Highest cutting performance with higher spindle speeds, higher feeds and larger cutting depths
- Shorter cycle times
- Quieter running, therefore better surface quality and protection of tools, spindles and machines
- Higher machining accuracy
- With Cool-Jet bores that can be sealed (Thread M4) and 6 bores
- With internal groove in the clamping bore

- Higher coolant flow rate due to optimized coolant bores
- With threaded holes for balancing screws

The long versions (A=oversize and ZG9 inch) with slim tips are especially versatile to use.

- High rigidity, slim at the tip, dampen vibrations
- Higher clamping forces
- Equally suited to high-speed manufacturing and heavy milling
- Universal usage, saves space in tool magazine

Optional:

- Cooling with Cool Flash for an extra charge (See pp. 182/183)
- Safe-Lock™ Pull out protection (See pages 184-187)

INCH	Clamping Ø D1 [inch]		3/8"	1/2"	5/8"	3/4"	1"
	Ø D2 [inch]		1.06	1.06	1.30	1.73	1.73
	Ø D3 [inch]		4.29	4.29	4.29	4.29	4.29
	L [inch]		1.65	1.85	1.97	2.05	2.28
Gage length A [inch]	ZG5 inch		5 ¹⁾	5 ¹⁾	5 ¹⁾	5	5
Order No.	A125.140...		.3/8Z.3.I	.1/2Z.3.I	.5/8Z.3.I	.3/4Z.3.I	.1Z.3.I
Safe-Lock™ Order No.	A125.140...		.3/8Z.37.I	.1/2Z.37.I	.5/8Z.37.I	.3/4Z.37.I	.1Z.37.I
Gage length A [inch]	oversize		7 ¹⁾	7 ¹⁾	7 ¹⁾	7	7
Order No.	A125.142...		.3/8Z.3.I	.1/2Z.3.I	.5/8Z.3.I	.3/4Z.3.I	.1Z.3.I
Safe-Lock™ Order No.	A125.142...		.3/8Z.37.I	.1/2Z.37.I	.5/8Z.37.I	.3/4Z.37.I	.1Z.37.I
Gage length A [inch]	ZG9 inch		9 ¹⁾	9 ¹⁾	9 ¹⁾	9	9
Order No.	A125.146...		.3/8Z.3.I	.1/2Z.3.I	.5/8Z.3.I	.3/4Z.3.I	.1Z.3.I
Safe-Lock™ Order No.	A125.146...		.3/8Z.37.I	.1/2Z.37.I	.5/8Z.37.I	.3/4Z.37.I	.1Z.37.I

METRIC	Clamping Ø D1 [mm]		10	12	16	20	25
	Ø D2 [mm]		27	27	33	44	44
	Ø D3 [mm]		109	109	109	109	109
	L [mm]		42	47	50	52	58
Gage length A [mm]	ZG130		130 ¹⁾	130 ¹⁾	130	130	130
Order No.	A125.140...		.10.3	.12.3	.16.3	.20.3	.25.3
Safe-Lock™ Order No.	A125.140...		.10.37	.12.37	.16.37	.20.37	.25.37
Gage length A [mm]	oversize		160 ¹⁾	160 ¹⁾	160	160	160
Order No.	A125.142...		.10.3	.12.3	.16.3	.20.3	.25.3
Safe-Lock™ Order No.	A125.142...		.10.37	.12.37	.16.37	.20.37	.25.37
Gage length A [mm]	ZG200		200 ¹⁾	200 ¹⁾	200	200	200
Order No.	A125.146...		.10.3	.12.3	.16.3	.20.3	.25.3
Safe-Lock™ Order No.	A125.146...		.10.37	.12.37	.16.37	.20.37	.25.37

Accessories

Cool Flash Order No. 91.100.40 See pages 182/183

Coolant tube Order No. 85.700.125

1) Thread M3, 2 bores

Technical data and availability subject to change without prior notice

HEAVY DUTY SHRINK CHUCK
HSK-A 125 · DIN 69893-1

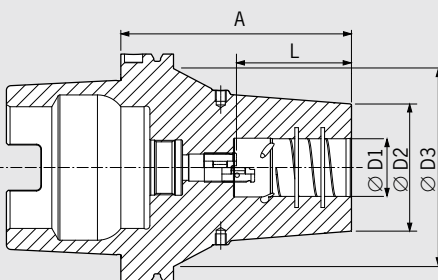

CERTIFICATE OF QUALITY	
<input checked="" type="checkbox"/>	Chuck body fine balanced G2.5 25,000 rpm or U<1 gmm
<input checked="" type="checkbox"/>	All functional surfaces fine machined
<input checked="" type="checkbox"/>	More accurate than DIN
<input checked="" type="checkbox"/>	Cool-Jet, can be sealed



Finally there is a holder for heavy machining that can replace the Weldon tool holder. The Heavy Duty Chuck is a shrink fit chuck designed for extreme cases. The contour is optimized for highest rigidity and clamping force.



- TIR less than 0.00012" (3 µm)
- Reinforced outer contour
- To shrink with 13 kW HD-Coil or with high performance shrink fit unit HAIMER Power Clamp Profi Plus (20 kW)
- With internal groove in the clamping bore

- With Cool-Jet bores that can be sealed (Thread M4) and 6 bores
- Higher coolant flow rate due to optimized coolant bores
- With threaded holes for balancing screws

Optional:

- Cooling with Cool Flash from 5/8"-1" for an extra charge (See pp. 182/183)
- Safe-Lock™ Pull out protection (See pages 184-187)

INCH	Clamping Ø D1 [inch]		5/8"	3/4"	1"	1 1/4"	1 1/2"	2"
	Ø D2 [inch]		2.01	2.28	2.48	2.76	3.23	3.23
	Ø D3 [inch]		4.29	4.29	4.29	4.29	4.29	4.29
	L [inch]		1.97	2.05	2.28	2.28	3.46	3.46
Gage length A [inch]	ZG5 inch		5	5	5	5	5 ¹⁾²⁾	5 ¹⁾²⁾
Order No.	A125.150...		.5/8Z.6.I	.3/4Z.6.I	.1Z.6.I	.11/4Z.6.I	.11/2Z.6.I	.2Z.6.I
Safe-Lock™ Order No.	A125.150...		.5/8Z.67.I	.3/4Z.67.I	.1Z.67.I	.11/4Z.67.I	.11/2Z.67.I	.2Z.67.I
Gage length A [inch]	oversize		7	7	7	7	7	7
Order No.	A125.152...		.5/8Z.6.I	.3/4Z.6.I	.1Z.6.I	.11/4Z.6.I	.11/2Z.6.I	.2Z.6.I
Safe-Lock™ Order No.	A125.152...		.5/8Z.67.I	.3/4Z.67.I	.1Z.67.I	.11/4Z.67.I	.11/2Z.67.I	.2Z.67.I
Gage length A [inch]	ZG9 inch		9	9	9	9	9	9
Order No.	A125.156...		.5/8Z.6.I	.3/4Z.6.I	.1Z.6.I	.11/4Z.6.I	.11/2Z.6.I	.2Z.6.I
Safe-Lock™ Order No.	A125.156...		.5/8Z.67.I	.3/4Z.67.I	.1Z.67.I	.11/4Z.67.I	.11/2Z.67.I	.2Z.67.I

METRIC	Clamping Ø D1 [mm]		16	20	25	32	40	50
	Ø D2 [mm]		51	58	63	70	82	82
	Ø D3 [mm]		109	109	109	109	109	109
	L [mm]		50	52	58	61	88	88
Gage length A [mm]	ZG130		130	130	130	130	130 ¹⁾²⁾	130 ¹⁾²⁾
Order No.	A125.150...		.16.6	.20.6	.25.6	.32.6	.40.6	.50.6
Safe-Lock™ Order No.	A125.150...		.16.67	.20.67	.25.67	.32.67	.40.67	.50.67
Gage length A [mm]	oversize		160	160	160	160	160	160
Order No.	A125.152...		.16.6	.20.6	.25.6	.32.6	.40.6	.50.6
Safe-Lock™ Order No.	A125.152...		.16.67	.20.67	.25.67	.32.67	.40.67	.50.67
Gage length A [mm]	ZG200		200	200	200	200	200	200
Order No.	A125.156...		.16.6	.20.6	.25.6	.32.6	.40.6	.50.6
Safe-Lock™ Order No.	A125.156...		.16.67	.20.67	.25.67	.32.67	.40.67	.50.67

Accessories

Cool Flash Upgrade



Order No. 91.100.40

See pages 182/183

Coolant tube



Order No. 85.700.125

1) Without back-up screws
2) Gage L = 87.5 mm /3.43"

POWER COLLET CHUCK
HSK-A 125 · DIN 69893-1



CERTIFICATE OF QUALITY	
<input checked="" type="checkbox"/>	Chuck fine balanced G2.5 25,000 rpm or U<1 gmm
<input checked="" type="checkbox"/>	All functional surfaces fine machined
<input checked="" type="checkbox"/>	More accurate than DIN

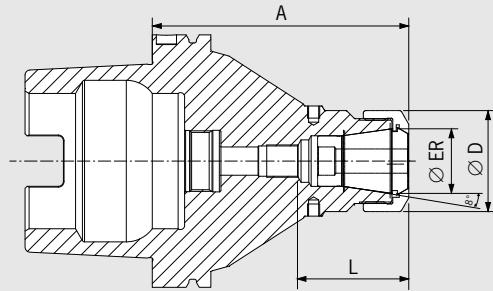

The Power Collet Chuck is designed for the highest machining capacity in high-speed manufacturing. The optimized design with improved construction combines high rigidity with vibration dampening features, giving more protection to the machine, spindle and tool. The universal Power Collet Chuck is a unique high performance chuck that can also be used with standard collets.

- High runout accuracy: < 0.00012" (3µm) at 3 × D with HAIMER Power Collets
- Also for standard collets ER according to ISO 15488 (formerly DIN 6499)
(Attention: By using standard collet ER length A will increase)
- High rigidity

- Runs smoother thanks to vibration absorbing geometry, yielding better surface finish and increased tool, spindle and machine protection
- Highest cutting performance with higher spindle speeds, higher feeds and larger cutting depths
- Shorter cycle times, higher machining accuracy, higher clamping forces
- Equally suited to high-speed manufacturing and heavy milling
- With threaded holes for balancing screws
- Optional: Cool-Jet bores on Power Collets from ER 25 Ø 1/4" (6 mm)
- Program of Power Collets on pages 154 – 157

INCH	ER		25	32
	Ø D [inch]		1.65	1.97
	Clamping range [inch]		1/8"-5/8"	1/8"-3/4"
	L [inch]		2.01	2.09
Gage length A [inch]	short		4	4
Order No.	A125.020...		.25.3.1	.32.3.1
Gage length A [inch]	ZG5 inch		5	5
Order No.	A125.024...		.25.3.1	.32.3.1
Gage length A [inch]	oversize		7	7
Order No.	A125.022...		.25.3.1	.32.3.1
Gage length A [inch]	ZG9 inch		9	9
Order No.	A125.026...		.25.3.1	.32.3.1

METRIC	ER		25	32
	Ø D [mm]		42	50
	Clamping range [mm]		2.0-16.0	2.0-20.0
	L [mm]		51	53
Gage length A [mm]	short		100	100
Order No.	A125.020...		.25.3	.32.3
Gage length A [mm]	ZG130		130	130
Order No.	A125.024...		.25.3	.32.3
Gage length A [mm]	oversize		160	160
Order No.	A125.022...		.25.3	.32.3
Gage length A [mm]	ZG200		200	200
Order No.	A125.026...		.25.3	.32.3

DIN 69893 HSK

FACE MILL ARBOR
HSK-A 125 · DIN 69893-1

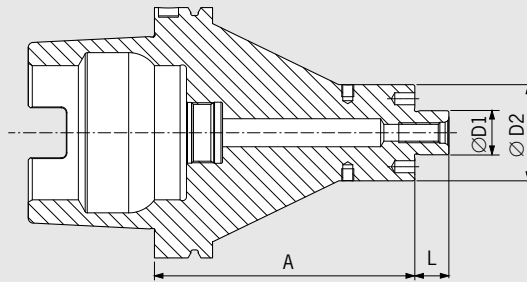

CERTIFICATE OF QUALITY





- Chuck body fine balanced
G2.5 25,000 rpm
or U < 1 gmm
- All functional surfaces machined
- More accurate than DIN





Use:

For holding face mill cutters and cutters with radial driving slot DIN 1880.

DIN 69882-3

- Reinforced outer contour
- Included in delivery: tightening bolt, With threaded holes for balancing screws, without coolant tube
- Metric sizes: With coolant exit bores on the end face for milling cutters with central cooling

INCH	Clamping Ø D1 [inch]		3/4"	1"
	Ø D2 [inch]		1.71	2.17
	L [inch]		0.67	0.67
Gage length A [inch]	short		4	4
Order No.	A125.050...		.3/4Z.3.I	.1Z.3.I
Gage length A [inch]	ZG5 inch		5	5
Order No.	A125.054...		.3/4Z.3.I	.1Z.3.I
Gage length A [inch]	oversize		7	7
Order No.	A125.052...		.3/4Z.3.I	.1Z.3.I
Gage length A [inch]	ZG9 inch		9	9
Order No.	A125.056...		.3/4Z.3.I	.1Z.3.I

METRIC	Clamping Ø D1 [mm]		22	27
	Ø D2 [mm]		48	60
	L [mm]		19	21
Gage length A [mm]	short		100	100
Order No.	A125.050...		.22.3.KKB	.27.3.KKB
Gage length A [mm]	ZG130		130	130
Order No.	A125.054...		.22.3.KKB	.27.3.KKB
Gage length A [mm]	oversize		160	160
Order No.	A125.052...		.22.3.KKB	.27.3.KKB
Gage length A [mm]	ZG200		200	200
Order No.	A125.056...		.22.3.KKB	.27.3.KKB

Accessories

Tightening bolt

Size D1			22	27
Order No.	85.300...		.22	.27

Wrench

Size D1			22	27
Order No.	84.400...		.22	.27

Balancing index rings

Size D1			22	27
Order No.	79.350...		.48	.60

Coolant bores

Order No.	91.100.03			
-----------	-----------	---	--	--

MINI SHRINK
HSK-E 25 · DIN 69893-5

CERTIFICATE OF QUALITY

- Chuck body fine balanced
G2.5 25,000 rpm or U<1 gmm
- All functional surfaces machined
- More accurate than DIN

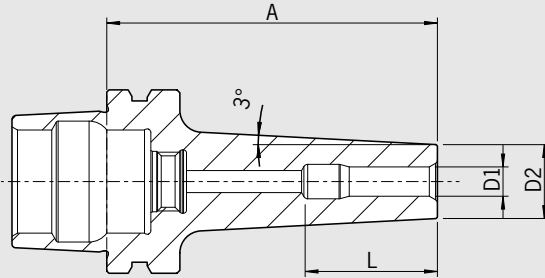

Low cutting forces at high rpm are typical in micro machining (die & mold, medical engineering, micro mechanical engineering). The slim and short design of the all new HSK-E25 series from HAIMER – which is well known from the HAIMER Mini Shrink tool holders – is perfectly suitable for the requirements of micro machining.

- No disturbing edges
- Highest runout accuracy: <0.00012° (3µm)
- Ideal to shrink with the HAIMER Power Clamp Nano

Available as:
– Mini Shrink (Ø 3-12) in two different lengths

METRIC	Clamping Ø D1 [mm]		03	04	05	06	06	06	08	10	10	10	12
	Ø D2 [mm]		09	10	11	12	12	12	14	16	16	16	18
	Ø D3 [mm]		—	—	—	—	—	—	—	18	18	18	20
	L [mm] ultra short		15	18	23	27.5	—	—	27	26.5	—	—	26
	L [mm] standard		15	18	28	37.5	32.5	37.5	27	41.5	36.5	41.5	35.5
Gage length A [mm]	ultra short		35 ¹⁾	35 ¹⁾	35 ¹⁾	40 ¹⁾	—	—	40 ¹⁾	40 ¹⁾	—	—	40 ¹⁾
Order No.	E25.185...		.03	.04	.05	.06			.08	.10			.12
Gage length A [mm]	standard		45	45	45	45 ²⁾	45	50	50	50 ²⁾	50	55	50
Order No.	E25.180...		.03	.04	.05	.06	.06.V2	.06.V3	.08	.10	.10.V2	.10.V3	.12

1) Only shrinkable with Power Clamp Nano

2) Without thread for coolant tube

Shrinking and cooling sleeves for Mini Shrink chucks								Order No.
Extra slim								
Size [mm]	Ø 03	Ø 04	Ø 05	Ø 06	Ø 08	Ø 10	Ø 12	
Order No. 80.105.14...	.2.01	.2.02	.2.03	.2.04	.2.05	.2.06	.2.07	
Standard								
Size [mm]	Ø 03	Ø 04	Ø 05	Ø 06	Ø 08	Ø 10	Ø 12	
Order No. 80.105.14...	.2.04	.2.08	.2.05	.2.09	.2.10	.2.11	.2.12	
Base								80.105.14.2.99
Set with base (12 pcs)								80.105.14.2.00

COLLET CHUCK MINI ER
HSK-E 25 · DIN 69893-5

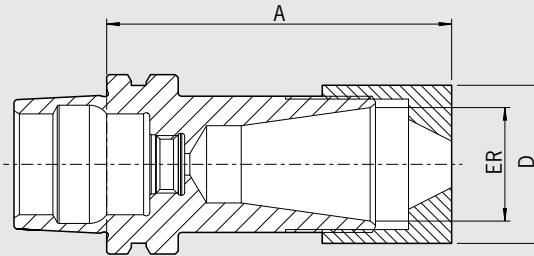

CERTIFICATE OF QUALITY	
<input checked="" type="checkbox"/>	Chuck body fine balanced G2.5 25,000 rpm or U<1 gmm
<input checked="" type="checkbox"/>	All functional surfaces machined
<input checked="" type="checkbox"/>	More accurate than DIN

Low cutting forces at high RPMs are typical in micro machining (die & mold, medical engineering, micro mechanical engineering). The slim and short design of the all new HSK-E25 series from HAIMER is perfectly suitable for the requirements of micro machining.

– Included in delivery: Locknut

Available as:

– Mini-ER collet chuck (Mini-ER 16) in two different lengths

Standard version, similar to DIN 69882-8

Mini-ER	ER	16
	∅ D [inch]	0.87
	Clamping range [inch]	0.02–0.39
Gage length A [inch]	ultra short	1.69
Order No.	E25.025...	.16.7¹⁾
Gage length A [inch]	short	1.89
Order No.	E25.020...	.16.7

1) Without thread for coolant tube

Accessories

Clamping nut

Size Mini ER 16
Order No. 915010- .0002

Torque Master torque wrench

Order No. 84.600.00

Insert torque wrench

Order No. 84.620... Mini ER 16 .16.1

POWER COLLET CHUCK
HSK-E 25 · DIN 69893-5



CERTIFICATE OF QUALITY

- Chuck body fine balanced
 G2.5 25,000 rpm
 or U < 1 gmm
- All functional surfaces machined
- More accurate than DIN

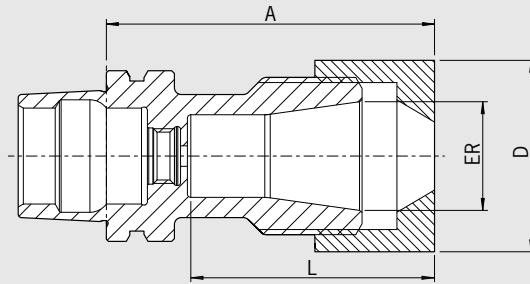

Low cutting forces at high RPMs are typical in micro machining (die & mold, medical engineering, micro mechanical engineering). The slim and short design of the all new HSK-E25 series from HAIMER is perfectly suitable for the requirements of micro machining.

- Included in delivery: Locknut
- Without thread for set screw
- Attention: By using standard collet ER length A will increase

Available as:
 - Power Collet Chuck ER 16

Power Collet Chuck for highest runout accuracy

INCH	ER	16
	∅ D [inch]	1.1
	Clamping range [inch]	1/8"–3/8"
	L [inch]	1.22
Gage length A [inch]	ultra short	1.77
Order No.	E25.025...	.16.3
	L [inch]	1.42
Gage length A [inch]	standard	1.89
Order No.	E25.020...	.16

Accessories

Power Collets

ER 16 (2.0–10.0)

Clamping ∅

Order No. 81.163...



02	03	04	05	06	08	10
.02	.03	.04	.05	.06	.08	.10

Collets ER Standard



Locknut (fine-balanced)

Size

Order No. 83.914...



ER 16
 .16

Power Collet Clamping wrench

Size

Order No. 84.650...



ER 16
 .16

Torque wrench for Power Collet Chucks

Order No. 84.600.00



SHRINK FIT CHUCK
HSK-E 32 · DIN 69893-5

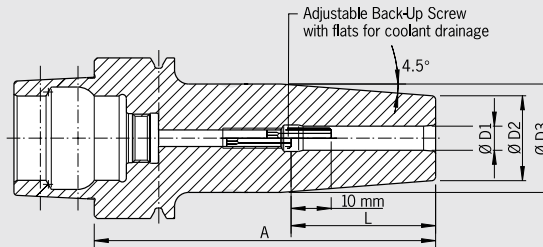

CERTIFICATE OF QUALITY	
<input checked="" type="checkbox"/>	Chuck body fine balanced G2.5 25,000 rpm or U<1gmm
<input checked="" type="checkbox"/>	All functional surfaces machined
<input checked="" type="checkbox"/>	More accurate than DIN

Use:

Shrink fit chuck suitable for use with all available shrink fit units.

Optional:

- Cooling with Cool-Jet for an extra charge (See page 180)
- Coling with Cool Flash for an extra charge (See pp. 182/183)

DIN 69893-5

- Heat resistant hot-working steel
- Hardened 54-2 HRC
- For HSS and solid carbide tools
- Shank tolerance h6
- Included in delivery: Shrink fit chuck with backup screw, without coolant tube

Standard version, similar to DIN 69882-8

INCH	Clamping Ø D1 [inch]		1/8"	3/16"	1/4"	3/8"
	Ø D2 [inch]		0.39	0.39	0.83	0.94
	L [inch]		0.35	0.59	1.42	1.65
Gage length A [inch]	short		2.36 ¹⁾	2.36 ¹⁾	2.76	3.15
Order No.	E32.140...		.1/8Z	.3/16Z	.1/4Z	.3/8Z

METRIC	Clamping Ø D1 [mm]		03	04	05	06	08	10
	Ø D2 [mm]		10	10	10	21	21	24
	Ø D3 [mm]		-	-	-	27	27	32
	L [mm]		09	12	15	36	36	42
Gage length A [mm]	short		60 ¹⁾	60 ¹⁾	60 ¹⁾	70 ²⁾	70 ²⁾	80 ²⁾
Order No.	E32.140...		.03	.04	.05	.06	.08	.10

1) Without back-up screw, without threads for balancing screws, with slits along the clamping bore for coolant around the tool

2) Without thread for balancing screws

Accessories

See accessories (pg. 143)

Spare parts Coolant Tube

Order No. 85.700... .32

Spare parts Back up Screws

See accessories

Cool-Jet bores Order No. 91.100.24

Cool Flash Upgrade Order No. 91.100.41 See pages 182/183

DIN 69893 HSK

SHRINK FIT CHUCK HSK-E 40 · DIN 69893-5

CERTIFICATE OF QUALITY

- Chuck body fine balanced
G2.5 25,000 rpm
or U < 1gmm
- All functional surfaces machined
- More accurate than DIN

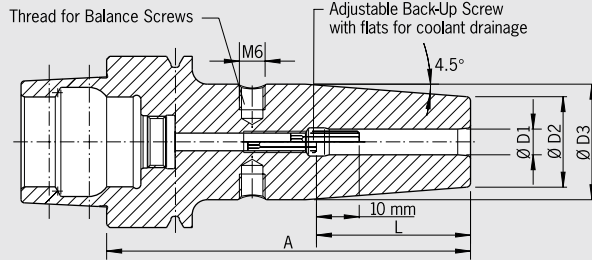

Use:

Shrink fit chuck suitable for use with all available shrink fit units.

- Fine-Balancing by balance screws.
- Included in delivery: Shrink fit chuck with back-up screw

Optional:

- Cooling with Cool-Jet for an extra charge (See page 180)
- Cooling with Cool Flash from 1/4" for an extra charge (See pp. 182/183)

INCH	Clamping Ø D1 [inch]	1/8"	3/16"	1/4"	5/16"	3/8"	1/2"	5/8"
	Ø D2 [inch]	0.39	0.39	0.83	0.83	0.94	0.94	1.06
	Ø D3 [inch]	-	-	1.06	1.06	1.26	1.26	1.34
	L [inch]	0.35	0.59	1.42	1.42	1.65	1.85	1.97
Gage length A [inch]	short	2.36 ¹⁾	2.36 ¹⁾	3.15	3.15	3.15	3.54	3.54
Order No.	E40.140...	.1/8Z	.3/16Z	.1/4Z	.5/16Z	.3/8Z	.1/2Z	.5/8Z

METRIC	Clamping Ø D1 [mm]	03	04	05	06	08	10	12	14	16
	Ø D2 [mm]	10	10	10	21	21	24	24	27	27
	Ø D3 [mm]	-	-	-	27	27	32	32	34	34
	L [mm]	09	12	15	36	36	42	47	47	50
Gage length A [mm]	ultra short	-	-	-	60 ²⁾	60 ²⁾	60 ³⁾	60 ³⁾	60 ³⁾	60 ³⁾
Order No.	E40.145...	-	-	-	.06	.08	.10	.12	.14	.16
Gage length A [mm]	short	60 ¹⁾	60 ¹⁾	60 ¹⁾	80	80	80	90	90	90
Order No.	E40.140...	.03	.04	.05	.06	.08	.10	.12	.14	.16

1) Without back-up screw, without thread for balancing screws, with slits along the clamping bore for coolant around the tool

2) Without back-up screw, without thread for balancing screws

3) Without back-up screw, without thread for balancing screws, without thread for coolant tube

Accessories

See accessories (pg. 143)

Spare parts Coolant Tube

Order No. 85.700...  .40

Spare parts Set of Balance Screws

See accessories 

Spare parts Back up Screws

See accessories 

Cool-Jet bores  Order No. 91.100.24

Cool Flash Upgrade  Order No. 91.100.41 See pages 182/183

SHRINK FIT CHUCK
HSK-E 50 · DIN 69893-5

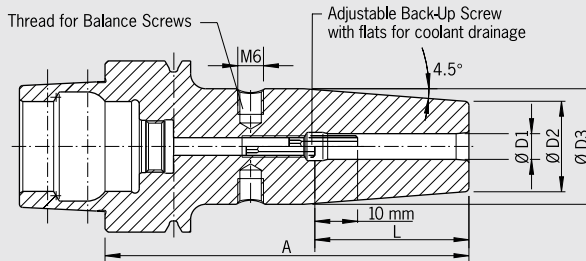

CERTIFICATE OF QUALITY

- Chuck body fine balanced G2.5 25,000 rpm or U<1gmm
- All functional surfaces machined
- More accurate than DIN

Use:

Shrink fit chuck suitable for use with all available shrink fit units.

Optional:

- Cooling with Cool-Jet for an extra charge (See page 180)
- Cooling with Cool Flash from diam. 1/4" for an extra charge (See pp. 182/183)

DIN 69893-5

- Included in delivery: Shrink fit chuck with backup screw, without coolant tube
- Heat resistant hot-working steel
- Hardened 54-2 HRC
- For HSS and solid carbide tools
- Shank tolerance h6

INCH	Clamping Ø D1 [inch]	1/8"	3/16"	1/4"	5/16"	3/8"	7/16"	1/2"	5/8"
	Ø D2 [inch]	0.39	0.39	0.83	0.83	0.94	0.94	0.94	1.06
	Ø D3 [inch]	-	-	1.06	1.06	1.26	1.26	1.26	1.34
	L [inch]	0.35	0.59	1.42	1.42	1.65	1.65	1.85	1.97
Gage length A [inch]	short	2.36 ¹⁾	2.36 ¹⁾	3.15	3.15	3.35	3.35	3.54	3.74
Order No.	E50.140...	.1/8Z	.3/16Z	.1/4Z	.5/16Z	.3/8Z	.7/16Z	.1/2Z	.5/8Z

Standard version, similar to DIN 69882-8

METRIC	Clamping Ø D1 [mm]	03	04	05	06	08	10	12	14	16
	Ø D2 [mm]	10	10	10	21	21	24	24	27	27
	Ø D3 [mm]	-	-	-	27	27	32	32	34	34
	L [mm]	09	12	15	36	36	42	47	47	50
Form E 50										
Gage length A [mm]	short	60 ¹⁾	60 ¹⁾	60 ¹⁾	80	80	85	90	90	95
Order No.	E50.140...	.03	.04	.05	.06	.08	.10	.12	.14	.16
Gage length A [mm]	ZG130	-	-	-	130	130	130	130	130	130
Order No.	E50.144...	-	-	-	.06	.08	.10	.12	.14	.16

Accessories

See accessories (pg. 143)

Shrink fit extensions



Set of Balance Screws



Coolant tube



Order No. 85.700.63

Reduction sleeves



Back up Screws



Cool-Jet bores



Order No. 91.100.24

Cool Flash Upgrade



Order No. 91.100.41

See pages 182/183

1) Without back-up screw, without threads for balancing screws, with slits along the clamping bore for coolant around the tool

MINI SHRINK HSK-E 32/40/50 · DIN 69893-5 INCH

– It is imperative that the correct adapter be used for both heating and cooling with all “Mini Shrink” chucks, in order to prevent overheating of the chuck.

CERTIFICATE OF QUALITY

- Chuck body fine balanced
G2.5 25,000 rpm
or U<1gmm
- All functional surfaces machined
- More accurate than DIN

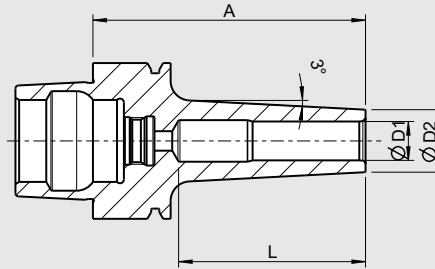

- Extreme slim design
- No disturbing edges
- TIR less than 0.00012" (3 µm)
- Ideal for the HAIMER Power Clamp
- For all solid carbide tools with shank tolerance h6
- With 3° slope for dies and molds

- With high clamping force
 - Tool holders fine balanced
 - Delivery without coolant tube
- Attention:** Heating and cooling only with shrink and cooling sleeves (see accessories)

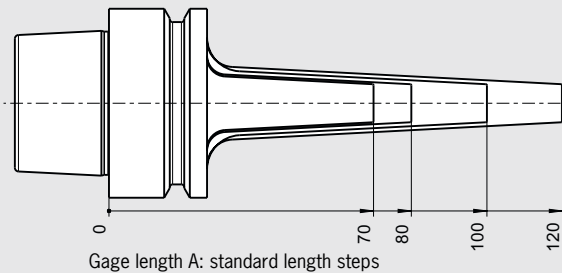
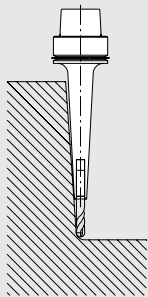

INCH	Clamping Ø D1 [inch]		1/8"	3/16"	1/4"	3/8"	1/2"
	Ø D2 [inch]		0.35	0.43	0.47	0.63	0.71
HSK-E32							
Gage length A [inch]	ultra short		2.37	2.37	2.37	2.37	2.37
Order No.	Standard	E32.185...	.1/8Z	.3/16Z	.1/4Z	.3/8Z	.1/2Z
Gage length A [inch]	short		2.76	2.76	2.76	2.76	2.76
Order No.	Standard	E32.183...	.1/8Z	.3/16Z	.1/4Z	.3/8Z	.1/2Z
HSK-E40							
Gage length A [inch]	ultra short		2.37	2.37	2.37	2.37	2.37
Order No.	Standard	E40.185...	.1/8Z	.3/16Z	.1/4Z	.3/8Z	.1/2Z
Gage length A [inch]	short		2.76	2.76	2.76	2.76	2.76
Order No.	Standard	E40.180...	.1/8Z	.3/16Z	.1/4Z	.3/8Z	.1/2Z

HSK-E 50

INCH	Clamping Ø D1 [inch]		1/8"	3/16"	1/4"	3/8"	1/2"
	Ø D2 standard [inch]		0.35	0.43	0.47	0.63	0.71
	Ø D2 extra slim [inch]		0.24	0.31	0.35	0.51	0.59
Gage length A [inch]	short		2.76	2.76	2.76	2.76	2.76
Order No.	Standard	E50.180...	.1/8Z	.3/16Z	.1/4Z	.3/8Z	.1/2Z
Order No.	extra slim	E50.170...	.1/8Z	.3/16Z	.1/4Z	.3/8Z	.1/2Z
Gage length A [inch]	ZG100		3.94	3.94	3.94	3.94	3.94
Order No.	Standard	E50.181...	–	.3/16Z	.1/4Z	.3/8Z	.1/2Z
Order No.	extra slim	E50.171...	.1/8Z	.3/16Z	.1/4Z	.3/8Z	.1/2Z

MINI SHRINK
 HSK-E 32/40/50 · DIN 69893-5
 METRIC

– It is imperative that the correct adapter be used for both heating and cooling with all “Mini Shrink” chucks, in order to prevent overheating of the chuck.

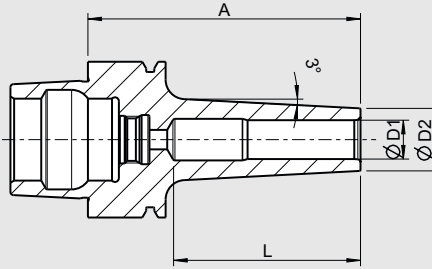
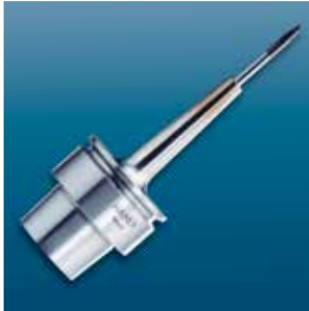

CERTIFICATE OF QUALITY	
<input checked="" type="checkbox"/>	Chuck body fine balanced G2.5 25,000rpm or U<1gmm
<input checked="" type="checkbox"/>	All functional surfaces machined
<input checked="" type="checkbox"/>	More accurate than DIN

HSK-E 32

METRIC	Clamping Ø D1 [mm]		03	04	05	06	08	10	12
	Ø D2 Standard [mm]		09	10	11	12	14	16	18
Gage length A [mm]	ultra short		60	60	60	60	60	60	60
Gage length L [mm]			—	43	43	43	38	42	41.5
Order No.	Standard E32.185...		.03	.04	.05	.06	.08	.10	.12
Gage length A [mm]	ZG80		80	80	80	80	80	80	80
Gage length L [inch]			—	63	63	63	38	48	48
Order No.	Standard E32.183...		.03	.04	.05	.06	.08	.10	.12

HSK-E 40

METRIC	Clamping Ø D1 [mm]		03	04	05	06	08	10	12
	Ø D2 Standard [mm]		09	10	11	12	14	16	18
	Ø D2 extra slim [mm]		06	07	08	09	11	13	15
Gage length A [mm]	ultra short		60	60	60	60	60	60	60
Gage length L [mm]			—	—	—	41	41	42	41.5
Order No.	Standard E40.185...		.03	.04	.05	.06	.08	.10	.12
Order No.	extra slim E40.175...		.03	.04	.05	.06	.08	.10	.12
Gage length A [mm]	short		70	70	70	70	70	70	70
Gage length L [mm]			—	—	—	51	51	48	48
Order No.	Standard E40.180...		.03	.04	.05	.06	.08	.10	.12
Order No.	extra slim E40.170...		.03	.04	.05	.06	.08	.10	.12
Gage length A [mm]	ZG80		80	80	80	80	80	80	80
Gage length L [inch]			—	—	—	61	61	48	48
Order No.	Standard E40.183...		.03	.04	.05	.06	.08	.10	.12
Order No.	extra slim E40.173...		.03	.04	.05	.06	.08	.10	.12

HSK-E 50

METRIC	Clamping Ø D1 [mm]		03	04	05	06	08	10	12
	Ø D2 Standard [mm]		09	10	11	12	14	16	18
	Ø D2 extra slim [mm]		06	07	08	09	11	13	15
Gage length A [mm]	short		70	70	70	70	70	70	70
Gage length L [mm]			—	—	—	—	—	48	48
Order No.	Standard E50.180...		.03	.04	.05	.06	.08	.10	.12
Order No.	extra slim E50.170...		.03	.04	.05	.06	.08	.10	.12
Gage length A [mm]	ZG80		80	80	80	80	80	80	80
Gage length L [mm]			—	—	—	—	—	48	48
Order No.	Standard E50.183...		.03	.04	.05	.06	.08	.10	.12
Order No.	extra slim E50.173...		.03	.04	.05	.06	.08	.10	.12
Gage length A [mm]	ZG100		—	—	100	100	100	100	100
Gage length L [mm]			—	—	—	—	—	48	48
Order No.	Standard E50.181...				.05	.06	.08	.10	.12
Order No.	extra slim E50.171...			.05	.06	.08	.10	.12	

MINI SHRINK SHRINK AND COOLING SLEEVES

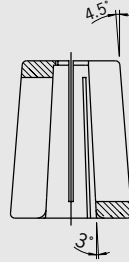

For shrinking and cooling of Mini Shrink chucks.

- Protects Mini Shrink chucks from overheating
- Extends lifetime of shrink fit chucks
- Secure and user friendly handling
- Cooling with standard cooling body 6 mm – 8 mm

Function

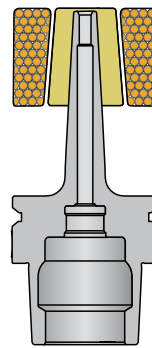
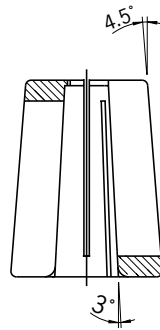

Heat up
With shrink and cooling sleeve

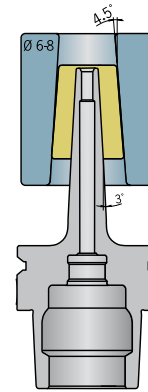

Cool down
With shrink and cooling sleeve
and cooling body \varnothing 6–8 mm



Shrinking and cooling sleeves for Mini Shrink chucks

Order No.

Shrinking and cooling sleeves for Mini Shrink chucks									Order No.
Extra slim									
Size [mm]	\varnothing 03	\varnothing 04	\varnothing 05	\varnothing 06	\varnothing 08	\varnothing 10	\varnothing 12		
Order No. 80.105.14...	.2.01	.2.02	.2.03	.2.04	.2.05	.2.06	.2.07		
Standard									
Size [mm]	\varnothing 03	\varnothing 04	\varnothing 05	\varnothing 06	\varnothing 08	\varnothing 10	\varnothing 12	\varnothing 16	
Order No. 80.105.14...	.2.04	.2.08	.2.05	.2.09	.2.10	.2.11	.2.12	.2.16	
Base									80.105.14.2.99
Set with base (12 pcs)									80.105.14.2.00

1) Not suitable for central cooling

POWER COLLET CHUCK
HSK-E 32/40/50 · DIN 69893-5

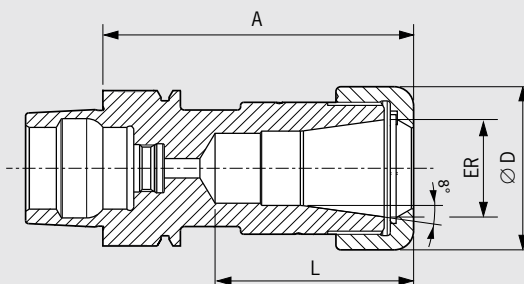

CERTIFICATE OF QUALITY

- Chuck body fine balanced
U < 1gmm
- All functional surfaces machined
- Taper tolerance AT3
- Coolant supply form ADB

The Power Collet Chuck is designed for the highest machining capacity in high-speed manufacturing. The optimized design with improved construction combines high rigidity with vibration dampening features, giving more protection to the machine, spindle and tool.

The universal Power Collet Chuck is a unique high performance chuck that can also be used with standard collets.

- High runout accuracy: < 0.00012" (3µm) at 3 × D with HAIMER Power Collets
- Also for standard collets ER according to ISO 15488 (formerly DIN 6499) (Attention: By using standard collet ER length A will increase)
- High rigidity

- Runs smoother thanks to vibration absorbing geometry, yielding better surface finish and increased tool, spindle and machine protection
- Highest cutting performance with higher spindle speeds, higher feeds and larger cutting depths
- Shorter cycle times, higher machining accuracy, higher clamping forces
- Equally suited to high-speed manufacturing and heavy milling
- Without thread for set screw
- Optional: Cool-Jet bores on Power Collets from ER 25 Ø 1/4"
- Program of Power Collets on pages 154 – 157

INCH	ER	16	25	32
	Ø D [inch]	1.1	1.65	1.97
	Clamping range [inch]	1/8"-3/8"	1/8"-5/8"	1/8"-3/4"
Form E32				
	L [inch]	1.26	1.53	
Gage length A [inch]	ultra short	1.97	2.36	
Order No.	E32.025...	.16.3	.25.3	
Form E40				
	L [inch]	1.22	1.51	1.85
Gage length A [inch]	ultra short	1.97	2.36	2.76
Order No.	E40.025...	.16.3	.25.3	.32.3
	L [inch]	1.69	2.01	2.09
Gage length A [inch]	short	3.15	3.15	3.15
Order No.	E40.020...	.16.3	.25.3	.32.3
Form E50				
	L [inch]	1.26	1.53	1.89
Gage length A [inch]	ultra short	2.36	2.56	2.95
Order No.	E50.025...	.16.3	.25.3	.32.3

Accessories

Locknut (fine-balanced)

Size	ER 16	ER 25	ER 32
Order No. 83.914...	.16	.25	.32

Clamping wrench  See page 158

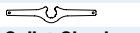
Torque Master torque wrench for Power Collet Chucks  See page 158

Order No. 84.600.00

Power Collets See page 154

Power Collets with Safe-Lock™ See page 156

Cool-Jet bores for Power Collets See page 157

Order No. 91.100.27

ER COLLET CHUCK HSK-E 32/40 · DIN 69893-5

CERTIFICATE OF QUALITY

- Chuck body fine balanced
G2.5 25,000 rpm
or U<1gmm
- All functional surfaces machined
- More accurate than DIN

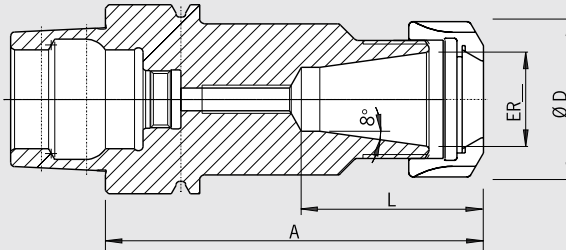

Use:

For clamping tools with cylindrical shank in ER collets.

- Locknut type HS (High-Speed, fine balanced, with slide coating for higher clamping forces)
- Balanced collet nuts with special slide coating for low friction and higher clamping forces
- Increasing size L possible upon request



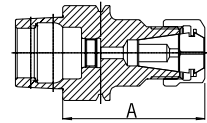



extra short



INCH	ER	ER11	ER16	ER25	ER32
	Ø D [inch]	0.75	1.1	1.65	1.97
	Clamping range [inch]	0.02-0.28	0.02-0.39	0.04-0.63	0.04-0.79
	Clamping range [mm]	0.5-7.0	0.5-10.0	1.0-16.0	1.5-20.0
Form E 32					
L [inch]		-	1.28	1.61	-
Gage length A [inch]	short	-	3.15	3.15	-
Order No.	E32.020...		.16	.25	
L [inch]		-	1.28	-	-
Gage length A [inch]	long	-	3.94	-	-
Order No.	E32.021...		.16		
Form E 40					
L [inch]		1.05	1.28	1.61	1.85
Gage length A [inch]	ultra short	2.36	2.36	2.76	2.76
Order No.	E40.025...	.11 ¹⁾	.16 ¹⁾	.25 ¹⁾	.32 ¹⁾
L [inch]		-	1.30	1.61	-
Gage length A [inch]	short	-	3.15	3.15	-
Order No.	E40.020...		.16	.25	

Accessories

See accessories (pg. 143)

Spare parts Collet nut HS (Highspeed), fine-balanced					
Ø ER			ER16	ER25	ER32
Order No.	83.912...		.16.HS	.25.HS	.32.HS
Spare parts Wrench					
Ø ER			ER11	ER16	-
Order No.	84.200...		.11	.16	-
Spare parts Wrench					
Ø ER			-	ER25	ER32
Order No.	84.200...		-	.25	.32
Spare parts Balancing index rings					
Ø ER			ER11	ER16	ER25
Order No.	79.350...		.19	.28	.42
Spare parts Adjusting Screw					
Ø ER			-	ER16	ER25
Order No.	85.800...		-	.34	.35
Spare parts Coolant Tube					
Ø ER			ER11	ER16	ER25
Order No.	85.700...		.50	.50	.50

1) Without thread for back-up screw

Technical data and availability subject to change without prior notice

ER COLLET CHUCK
HSK-E 50 · DIN 69893-5

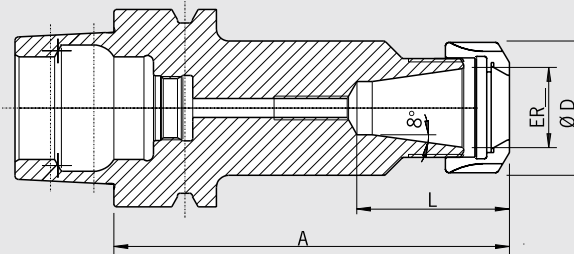

CERTIFICATE OF QUALITY

- ✓ Chuck body fine balanced
G2.5 25,000 rpm
or U<1gmm
- ✓ All functional surfaces machined
- ✓ More accurate than DIN



Use:

For clamping tools with cylindrical shank in ER collets.

- Locknut type HS (High-Speed, fine balanced, with slide coating for higher clamping forces)
- Balanced collet nuts with special slide coating for low friction and higher clamping forces
- Increasing size L possible upon request

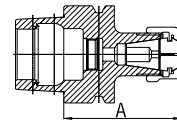
extrashort



INCH	ER	ER11	ER16	ER20	ER25	ER32
	Ø D [inch]	0.75	1.1	1.34	1.65	1.97
	Clamping range [inch]	0.02-0.28	0.02-0.39	0.04-0.51	0.04-0.63	0.04-0.79
	Clamping range [mm]	0.5-7.0	0.5-10.0	1.5-13.0	1.0-16.0	1.5-20.0
L [inch]		1.05	1.28	1.73	1.61	1.85
Gage length A [inch]	ultra short 	2.36	2.36	2.76	2.76	3.15
Order No.	E50.025...	.11 ¹⁾	.16 ¹⁾	.20 ¹⁾	.25 ¹⁾	.32 ¹⁾
L [inch]		-	1.28	-	1.61	1.85
Gage length A [inch]	short 	-	3.94	-	3.94	3.94
Order No.	E50.020...	-	.16	-	.25	.32

Accessories

See accessories (pg. 143)

Spare parts Collet nut, Pre-balanced

Ø ER	ER11	ER16	ER20	ER25	ER32
Order No. 83.912...	.11	.16	.20	.25	.32

Spare parts Collet nut HS (Highspeed), fine-balanced

Ø ER	ER16	ER20	ER25	ER32
Order No. 83.912...	.16.HS	.20.HS	.25.HS	.32.HS

Spare parts Wrench

Ø ER	ER11	ER16	ER20
Order No. 84.200...	.11	.16	.20

Spare parts Wrench

Ø ER	ER25	ER32
Order No. 84.200...	.25	.32

Spare parts Balancing index rings

Ø ER	ER11	ER16	ER20	ER25	ER32
Order No. 79.350...	.19	.28	.34	.32	.40

Spare parts Collet

Ø ER 
See accessories

Spare parts Adjusting Screw

Ø ER	ER16	ER20	ER25	ER32
Order No. 85.800...	.34	.34	.34	.35

Spare parts Coolant Tube

Ø ER	ER11	ER16	ER20	ER25	ER32
Order No. 85.700...	.50	.50	.50	.50	.50

FACE MILL ARBOR
HSK-E 50 · DIN 69893-5

CERTIFICATE OF QUALITY

- Chuck body fine balanced
G2.5 25,000 rpm
or U<1gmm
- All functional surfaces machined
- More accurate than DIN

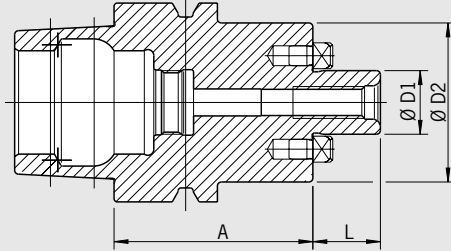

Use:

For clamping face-mill cutters.
With coolant exit bores on the end face for milling cutters with central cooling.

– Included in delivery: Face Mill Arbor and clamping screw

METRIC	Clamping Ø D1 [mm]	16	22	27
	L [mm]	17	19	21
	Ø D2 [mm]	36	48	60
Gage length A [mm]	short	50	60	60
Order No.	E50.050...	.16.KKB	.22.KKB	.27.KKB

Accessories

See accessories (pg. 143)

Spare parts Clamping Screw

Ø D1 [mm]		16	22	27
Order No.	85.300...	.16	.22	.27

Spare parts Wrench

Ø D1 [mm]		16	22	27
Order No.	84.400...	.16	.22	.27

Spare parts Balancing index rings

Ø D1 [mm]		16	22	27
Order No.	79.350...	.36	.48	.60

Spare parts Coolant Tube

Ø D1 [mm]		16	22	27
Order No.	85.700...	.50	.50	.50

Coolant bores

Order No.	91.100.03	
-----------	-----------	--

SHRINK FIT CHUCK
HSK-F 63 · DIN 69893-6

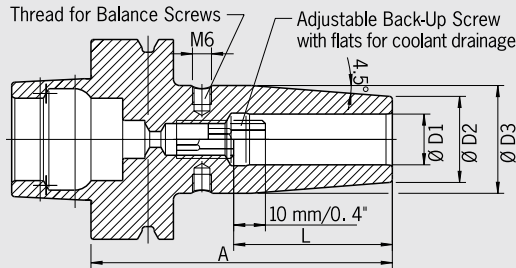

CERTIFICATE OF QUALITY	
<input checked="" type="checkbox"/>	Chuck body fine balanced G2.5 25,000rpm or U<1gmm
<input checked="" type="checkbox"/>	All functional surfaces machined
<input checked="" type="checkbox"/>	More accurate than DIN

Use:

Shrink fit chuck suitable for use with all available shrink fit units.

- Included in delivery: Shrink fit chuck with back-up screw
- Cool-Jet option available upon request (See page 180)

- Heat resistant hot-working steel
- Hardened 54-2 HRC
- For HSS and solid carbide tools
- Shank tolerance h6
- With threaded holes for balancing screws

INCH	Clamping Ø D1 [inch]	1/8"	3/16"	1/4"	5/16"	3/8"	1/2"	5/8"	3/4"	1"
	Ø D2 [inch]	0.39	0.39	0.83	0.83	0.94	0.94	1.06	1.3	1.73
	Ø D3 [inch]	-	-	1.06	1.06	1.26	1.26	1.34	1.65	2.09
	L [inch]	0.35	0.59	1.42	1.42	1.65	1.85	1.97	2.05	.28
Gage length A [inch]	short	3.15 ¹⁾	3.15 ¹⁾	3.15	3.15	3.35	3.54	3.74	3.94	4.53
Order No.	F63.140...	.1/8Z	.3/16Z	.1/4Z	.5/16Z	.3/8Z	.1/2Z	.5/8Z	.3/4Z	.1Z

Standard version, similar to DIN 69882-8

METRIC	Clamping Ø D1 [mm]	03	04	05	06	08	10	12	16	20	25
	Ø D2 [mm]	10	10	10	21	21	24	24	27	33	44
	Ø D3 [mm]	-	-	-	27	27	32	32	34	42	53
	L [mm]	09	12	15	36	36	42	47	50	52	58
Gage length A [mm]	short	80 ¹⁾	80 ¹⁾	80 ¹⁾	80	80	85	90	95	100	115
Order No.	F63.140...	.03	.04	.05	.06	.08	.10	.12	.16	.20	.25
Gage length A [mm]	ZG130	-	-	-	130	130	130	130	130	130	130
Order No.	F63.144...	-	-	-	.06	.08	.10	.12	.16	.20	.25

1) Without back-up screw, without threads for balancing screws, with slits along the clamping bore for coolant around the tool

Accessories

See accessories (pg. 143)

Spare parts Set of Balance Screws

See accessories



Spare parts Back up screws

See accessories



ER COLLET CHUCK
HSK-F 63 · DIN 69893-6

CERTIFICATE OF QUALITY

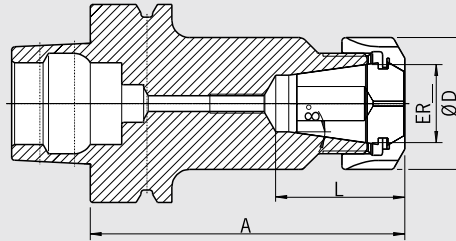

- Chuck body fine balanced
G2.5 25,000 rpm
or U<1gmm
- All functional surfaces machined
- More accurate than DIN



Use:

For clamping tools with cylindrical shank in ER collets according to ISO 15488.

- Included in delivery: locknut (balanced, with slide coating for higher clamping forces)
- Locknut type HS (High-Speed, fine balanced, with slide coating for higher clamping forces) for an extra charge
- Increasing size L possible upon request

INCH	ER	ER11	ER16	ER20	ER25	ER32	ER40
	ØD [inch]	0.75	1.1	1.34	1.65	1.97	2.48
	Clamping range [inch]	0.02–0.28	0.02–0.39	0.06–0.51	0.04–0.63	0.06–0.79	0.98–1.02
	Clamping range [mm]	0.5–7.0	0.5–10.0	1.5–13.0	1.0–16.0	1.5–20.0	2.5–26.0
L [inch]		1.93	1.93	1.93	1.89	1.98	2.09
Gage length A [inch]	ultra short 	2.95	2.95	2.95	2.95	2.95	2.95
Order No.	F63.025...	.11	.16	.20	.25	.32	.40
L [inch]		0.91	1.28	1.51	1.61	1.85	.09
Gage length A [inch]	short 	3.94	3.94	3.94	3.94	3.94	4.72
Order No.	F63.020...	.11	.16	.20	.25	.32	.40

Accessories

See accessories (pg. 143)

Spare parts Collet nut, Pre-balanced

Ø ER	ER11	ER16	ER20	ER25	ER32	ER40	
Order No.	83.912... 	.11	.16	.20	.25	.32	.40

Spare parts Collet nut HS (Highspeed), fine-balanced

Ø ER	ER16	ER20	ER25	ER32	ER40	
Order No.	83.912... 	.16.HS	.20.HS	.25.HS	.32.HS	.40.HS

Spare parts Wrench

Ø ER	ER11	ER16	ER20	-	-	-
Order No.	84.200... 	.11	.16	.20		

Spare parts Wrench

Ø ER	-	-	-	ER25	ER32	ER40
Order No.	84.200... 			.25	.32	.40

Spare parts Balancing index rings

Ø ER	ER11	ER16	ER20	ER25	ER32	ER40	
Order No.	79.350... 	.19	.28	.34	.42	.48	.50

Spare parts Collet

Ø ER 

See accessories

Spare parts Adjusting Screw

Ø ER	-	ER16	ER20	ER25	ER32	ER40
Order No.	85.800... 	.34	.34	.34	.35	.35

FACE MILL ARBOR
HSK-F 63 · DIN 69893

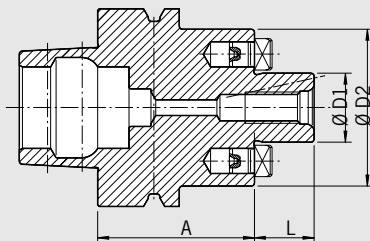

CERTIFICATE OF QUALITY	
<input checked="" type="checkbox"/>	Chuck body fine balanced G2.5 25,000 rpm or U<1gmm
<input checked="" type="checkbox"/>	All functional surfaces machined
<input checked="" type="checkbox"/>	More accurate than DIN

Use:

For holding face mill cutters and cutters with radial driving slot DIN 1880 and exceeding clamping diameter 40 according to DIN 2079 is also possible (4 additional tapping holes).

With coolant exit bores on the end face for milling cutters with central cooling.

DIN 69882

- Included in delivery: tightening bolt, without coolant tube
- Coolant bores on front side at an extra charge

METRIC	Clamping Ø D1 [mm]	22	27
	Ø D2 [mm]	48	60
	L [mm]	19	21
Gage length A [mm]	short	50	60
Order No.	F63.050...	.22.KKB	.27.KKB



Accessories

Tightening bolt

Size D1			22	27
Order No.	85.300...		.22	.27

Wrench

Size D1			22	27
Order No.	84.400...		.22	.27

Balancing index rings

Size D1			22	27
Order No.	79.350...		.48	.60

Coolant bores

Order No.	91.100.03			
-----------	-----------	---	--	--

HSK-F80 MAKINO SHRINK FIT CHUCK INCH

CERTIFICATE OF QUALITY

- Chuck fine balanced
G2.5 33,000 rpm or U < 1gmm
- Balanceable via screws M6
- All functional surfaces fine machined
- With thread for coolant tube

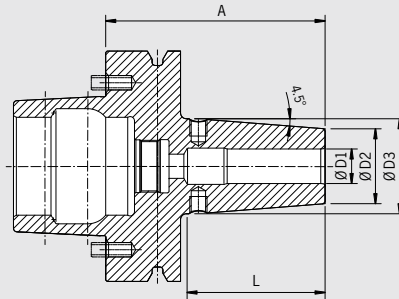

The HAIMER HSK-F80 Makino Shrink fit Chucks provide the highest machining capacity in high-speed manufacturing. The optimized design combines high rigidity with vibration dampening, which protects machine, spindle and tool.

- All pre-balanced to G2.5 @ 33,000 RPM or U < 1gmm
- All standard balanceable via set screws
- Short gage length per machine builders recommendation
- Dampen vibrations, high clamping force
- Equally suited to high-speed manufacturing and heavy milling
- Highest cutting performance with higher spindle speeds, higher feeds and larger cutting depths
- Shorter cycle times
- Quieter running, therefore better surface quality and protection of cutting tools, machine spindles and machines
- Higher machining accuracy

Use:

Shrink fit chuck suitable for use with all available shrink fit units.

- Heat resistant hot-working steel
- Hardened 54-2 HRC
- For HSS and solid carbide tools
- Shank tolerance h6
- With thread for coolant tube
- With bores for Balluf-Chip
- Snap Ring groove
- Cooling with Cool-Jet for an extra charge
- Cooling with Cool Flash for an extra charge (See pp. 182/183)







Standard Version

INCH	Clamping Ø D1 [inch]	1/4"	5/16"	3/8"	7/16"	1/2"	5/8"	3/4"	1"	1 1/4"
	Ø D2 [inch]	0.826	0.826	1.003	1.023	1.023	1.141	1.397	1.83	1.772
	Ø D3 [inch]	1.063	1.063	1.220	1.260	1.300	1.417	1.614	2.047	2.087
	L [inch]	1.417	1.417	1.693	1.693	1.890	2.008	2.008	1.930	2.560
Gage length A [inch]	ultra short 	3	3	3	3	3	3	3	3	3.5
Order No.	F80M.145...	.1/4z ¹⁾	.5/16z ¹⁾	.3/8z	.7/16z	.1/2z	.5/8z	.3/4z	.1z	.11/4z

Extra ultrashort Version

INCH	Clamping Ø D1 [inch]	3/4"	1"
	Ø D2 [inch]	1.398	1.811
	Ø D3 [inch]	—	—
	L [inch]	1.713	1.850
Gage length A [inch]	extra ultra short 	2.75	2.75
Order No.	F80M.145...	.3/4z.5.i	.1z.5.i
Suitable Cooling adapter	80.105...	.16.0045	.18.0011

Accessories

Shrink fit extensions			
Set of Balance Screws		Order No. 80.203.00	
Coolant tube		Order No. 85.700.63	
Back up Screws			
Cool-Jet bores		Order No. 91.100.24	See page 180
Cool Flash Upgrade		Order No. 91.100.41	See pages 182/183

1) With back-up screw

HSK-F80 MAKINO SHRINK FIT CHUCK METRIC

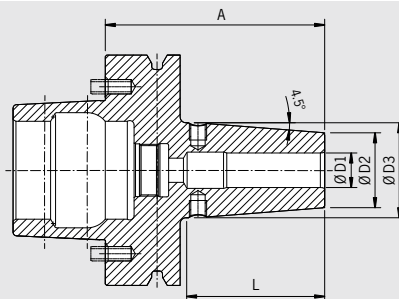

CERTIFICATE OF QUALITY

- Chuck fine balanced
G2.5 33,000 rpm or U < 1gmm
- Balanceable via screws M6
- All functional surfaces fine machined
- With thread for coolant tube

The HAIMER HSK-F80 Makino Shrink fit Chucks provide the highest machining capacity in high-speed manufacturing. The optimized design combines high rigidity with vibration dampening, which protects machine, spindle and tool.

- All pre-balanced to G2.5@33,000 RPM or U < 1gmm
- All standard balanceable via set screws
- Short gage length per machine builders recommendation
- Dampen vibrations, high clamping force
- Equally suited to high-speed manufacturing and heavy milling
- Highest cutting performance with higher spindle speeds, higher feeds and larger cutting depths
- Shorter cycle times
- Quieter running, therefore better surface quality and protection of cutting tools, machine spindles and machines
- Higher machining accuracy

Use:

Shrink fit chuck suitable for use with all available shrink fit units.

- Heat resistant hot-working steel
- Hardened 54-2 HRC
- For HSS and solid carbide tools
- Shank tolerance h6
- With thread for coolant tube
- Cooling with Cool-Jet for an extra charge
- Cooling with Cool Flash for an extra charge (See pp. 182/183)







Standard Version

METRIC	Clamping Ø D1 [mm]	6	8	10	12	14	16	20	25
	Ø D2 [mm]	21	21	26	26	29	29	35.5	46.5
	Ø D3 [mm]	27	27	32	33	36	36	41	52
	L [mm]	36	36	43	48	48	51	50.5	49
Gage length A [mm]	ultra short 	76.2	76.2	76.2	76.2	76.2	76.2	76.2	76.2
Order No.	F80M.145...	.06 ¹⁾	.08 ¹⁾	.10	.12	.14	.16	.20	.25

Extra ultrashort Version

METRIC	Clamping Ø D1 [mm]	20	25
	Ø D2 [mm]	35.5	46
	Ø D3 [mm]	—	—
	L [mm]	43.5	47
Gage length A [mm]	ultra short 	70	70
Order No.	F80M.145...	.20	.25
Suitable Cooling adapter	80.105...	.16.0045	.18.0011

Accessories

Shrink fit extensions		
Set of Balance Screws		Order No. 80.203.00
Coolant tube		Order No. 85.700.63
Back up Screws		
Cool-Jet bores		Order No. 91.100.24
Cool Flash Upgrade		Order No. 91.100.41

See page 180

See pages 182/183

HSK-F80 MAKINO ER COLLET CHUCK

CERTIFICATE OF QUALITY

- Chuck fine balanced
G2.5 33,000 rpm or U< 1gmm
- Balanceable via screws M6
- All functional surfaces fine machined
- With thread for coolant tube

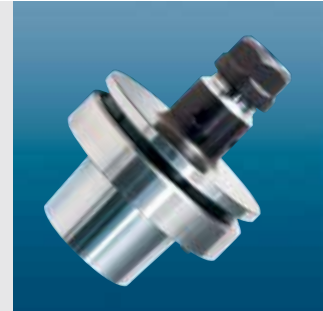
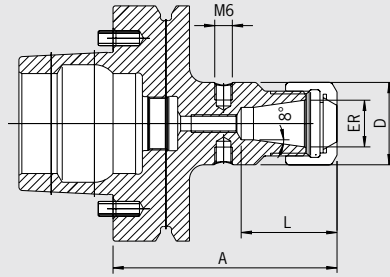

The HAIMER HSK-F80 Makino ER collet chucks provide a universal clamping solution for high-speed manufacturing. The optimized design combines a highly accurate universal clamping system for cutting tools.

- All pre-balanced to G2.5@33,000 RPM or U < 1 gmm
- All standard balanceable via screws
- Short gage length per machine builders recommendation
- Balanced nuts with special slide coating for low friction and high clamping forces
- Great for drilling
- Good clamping force
- Higher machining accuracy

Use:

For clamping tools with cylindrical shank in collets according to ISO 15488.

- Included in delivery: Locknut (balanced, with slide coating for higher clamping forces)
- Locknut type HS (high-speed, fine-balanced, with slide coating for higher clamping forces) available for an extra charge
- With threaded holes for balancing screws

INCH	ER	11	16	20	25	32	40
	Clamping range [inch]	0.02–0.276	0.02–0.394	0.059–0.512	0.039–0.63	0.02–0.787	0.098–1.024
	Ø D [inch]	1.062	1.102	1.574	1.653	1.968	2.483
	L [inch]	1.043	1.279	1.515	1.889	1.850	2.086
Gage length A [inch]	ultra short	3	3	3	3	3	3
Order No.	F80M.025...	.11	.16	.20	.25	.32	.40

METRIC	ER	11	16	20	25	32	40
	Clamping range [mm]	0.5–7	0.5–10	1.5–13	1–16	1.5–20	2.5–26
	Ø D [mm]	27	28	40	42	50	60
	L [mm]	27	33	38.5	48	47	53
Gage length A [mm]	ultra short	76.2	76.2	76.2	76.2	76.2	76.2
Order No.	F80M.025...	.11	.16	.20	.25	.32	.40

Accessories

Collets

Locknut (pre-balanced)

Size		ER11	ER16	ER20	ER25	ER32	ER40
Order No.	83.912...	.11	.16	.20	.25	.32	.40

Locknut HS (high-speed), fine-balanced

Size		—	ER16	ER20	ER25	ER32	ER40
Order No.	83.912...		.16.HS	.20.HS	.25.HS	.32.HS	.40.HS

Set of balance screws

Order No.	80.203.00
-----------	-----------

DIN 69893 HSK

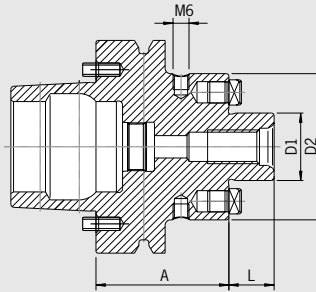
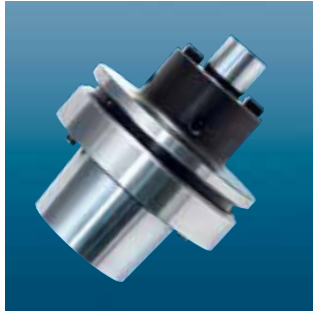

CERTIFICATE OF QUALITY

- Chuck fine balanced
G2.5 33,000 rpm
- Balanceable via screws M6
- Integrated thread for coolant tube



The HAIMER HSK-F80 Makino Face-mill arbors provide a solid base for face-mill cutters for high-speed manufacturing. The optimized design combines a highly accurate universal clamping system for cutting tools.



Use:

For holding face-mill cutters and milling cutters with radial driving slot DIN 1880

- All Pre-balanced to G2.5@33,000 RPM
- All standard as a balanceable for fine tune balancing capability
- Short gage length per machine builders recommendation
- Higher machining accuracy due to proper construction

- Comprising: Tightening bolt, without coolant tube
- Coolant bores on front side available for an extra charge
- With threaded holes for balancing screws

INCH	Clamping Ø D1 [inch]	3/4"	1"
	Ø D2 [inch]	1.710	2.165
	L [inch]	0.669	0.669
Gage length A [inch]	ultra short	1.968	1.968
Order No.	F80M.050... 	.3/4z	.1z
Gage length A [inch]	short	3.937	3.937
Order No.	F80M.051... 	...3/4z	.1z

METRIC	Clamping Ø D1 [mm]	19.05	25.4
	Ø D2 [mm]	43.45	55
	L [mm]	17	17
Gage length A [inch]	ultra short	50	50
Order No.	F80M.050... 	.3/4z	.1z
Gage length A [inch]	short	100	100
Order No.	F80M.051... 	...3/4z	.1z

Accessories

Tightening bolt

Ø D1 [mm]	3/4"	1"
Order No.	85.300...	.3/4z
		.1z

Coolant bores

Order No. 91.100.03

Set of balance screws

Order No. 80.203.00

HAIMER CAPTO™

Form C6

ISO 26623

Shrink Fit Chuck	136
Power Shrink Chuck	137
ER Collet Chuck	138
Power Collet Chuck	139
Weldon Tool Holder	140
Face Mill Arbor	141



SHRINK FIT CHUCK
HAIMER CAPTO™ C6 · ISO 26623-1

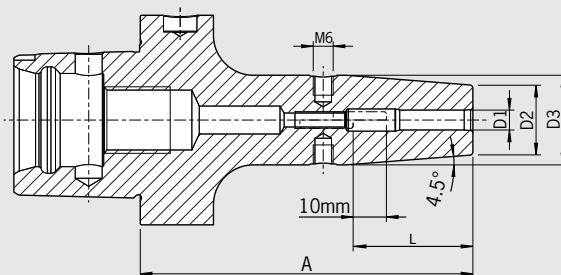

CERTIFICATE OF QUALITY	
<input checked="" type="checkbox"/>	Chuck body fine balanced G2.5 25,000 rpm
<input checked="" type="checkbox"/>	All functional surfaces machined
<input checked="" type="checkbox"/>	More accurate than DIN

Shrink fit chuck suitable for use with all available shrink fit units.

Available from Ø 3 to Ø 32.

- Interface with a unique tapered polygon and flange location face
- Exact positioning in the spindle
- Highest runout accuracy, torque and rigidity
- Innovative modular tool system with highest precision
- Suitable for both turning and milling centers
- With threaded holes for balancing screws
- Inch sizes with Cool-Jet, metric sizes with Cool-Jet optional

Optional:

- Metric sizes: Cooling with Cool-Jet for an extra charge (See page 180)
- Cooling with Cool Flash from diam. ¼" - 1" for an extra charge (See pp. 182/183)

ISO 26623

- Delivery: With back-up screw

INCH	Clamping Ø D1 [mm]	1/4"	5/16"	3/8"	7/16"	1/2"	5/8"	3/4"	7/8"	1"	1 1/4"
	Ø D2 [mm]	0.83	0.83	0.94	0.94	0.94	1.06	1.30	1.30	1.73	1.73
	Ø D3 [mm]	1.06	1.06	1.26	1.26	1.26	1.34	1.65	1.65	2.09	2.09
	L [mm]	1.42	1.42	1.65	1.65	1.85	1.97	2.05	2.05	2.28	2.28
Gage length A [inch]	short	3.15		3.15		3.15	3.35	3.35		3.54	
Order No.	CC6.140...	.1/4Z.4	-	.3/8Z.4	-	.1/2Z.4	.5/8Z.4	.3/4Z.4	-	.1Z.4	-
Gage length A [inch]	long	3.94	3.94	3.94	3.94	3.94	3.94	3.94	3.94		
Order No.	CC6.141...	.1/4Z.4	.5/16Z.4	.3/8Z.4	.7/16Z.4	.1/2Z.4	.5/8Z.4	.3/4Z.4	.7/8Z.4	-	-
Gage length A [inch]	ZG130	5.12		5.12		5.12	5.12	5.12		5.12	5.12
Order No.	CC6.144...	.1/4Z.4	-	.3/8Z.4	-	.1/2Z.4	.5/8Z.4	.3/4Z.4	-	.1Z.4	.11/4Z.4

METRIC	Clamping Ø D1 [mm]	03	04	05	06	08	10	12	14	16	18	20	25	32
	Ø D2 [mm]	10	10	10	21	21	24	24	27	27	33	33	44	44
	Ø D3 [mm]	-	-	-	27	27	32	32	34	34	42	42	53	53
	L [mm]	09	12	15	36	36	42	47	47	50	50	52	58	58
Gage length A [mm]	short	80 ¹⁾	80 ¹⁾	80 ¹⁾	80	80	80	80	85	85	85	85	90	95
Order No.	CC6.140...	.03	.04	.05	.06	.08	.10	.12	.14	.16	.18	.20	.25	.32
Gage length A [mm]	long	-	-	-	100	100	100	100	100	100	100	100	-	-
Order No.	CC6.141...				.06	.08	.10	.12	.14	.16	.18	.20		
Gage length A [mm]	ZG130	-	-	-	130	130	130	130	130	130	130	130	130	130
Order No.	CC6.144...				.06	.08	.10	.12	.14	.16	.18	.20	.25	.32
Gage length A [mm]	oversize	-	-	-	160	160	160	160	160	160	160	160	160	160
Order No.	CC6.142...				.06	.08	.10	.12	.14	.16	.18	.20	.25	.32

Accessories

Cool Flash

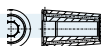

Order No. 91.100.40

See page 182

1) Without back-up screw, without threads for balancing screws, with slits along the clamping bore for cooling from outside

POWER SHRINK CHUCK

HAIMER CAPTO™ C6 · ISO 26623-1



CERTIFICATE OF QUALITY

- Chuck body fine balanced
G2.5 25,000 rpm
- All functional surfaces fine machined
- More accurate than DIN

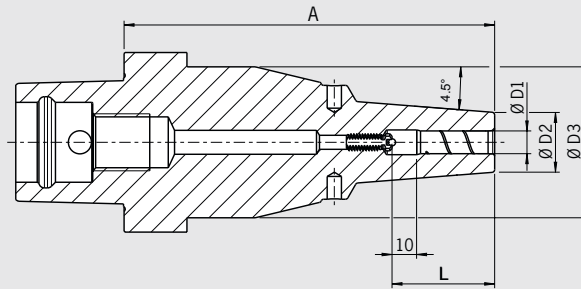

The Power Shrink Chuck is designed for the highest cutting performance in high-speed manufacturing. The optimized design combines high rigidity with vibration dampening, which protects the machine, spindle and tool.

- Highest cutting performance with higher spindle speeds, higher feeds and larger cutting depths
- Shorter cycle times, higher machining accuracy
- Quieter running, therefore better surface quality and protection of tools, spindles and machines
- With threaded holes for balancing screws
- Cool-Jet bores that can be sealed included
- Cooling with Cool Flash for an extra charge (See pp. 182/183)

The long versions (A=130) with slim tips are especially versatile to use.

- High rigidity, slim at the tip, dampen vibrations
- High clamping force
- Equally suited to high-speed manufacturing and heavy milling
- Universal usage, saves space in tool magazine

INCH	Clamping Ø D1 [inch]	1/4"	5/16"	3/8"	7/16"	1/2"	5/8"	3/4"	7/8"	1"	1 1/4"
	Ø D2 [inch] ultra short	0.87	0.87	1.04	1.04	1.04	1.16	1.40	1.40	1.77	1.77
	Ø D3 [inch] ultra short	—	—	—	—	—	—	—	—	—	—
	L [inch] ultra short	1.50	1.50	1.69	1.81	1.81	2.00	2.09	2.09	2.36	2.56
Gage length A [inch]	ultra short	2.56	2.56	2.56	2.56	2.56	2.76	2.76	2.76	3.15	3.15
Order No.	CC6.145...	.1/4Z.3	.5/16Z.3	.3/8Z.3	.7/16Z.3	.1/2Z.3	.5/8Z.3	.3/4Z.3	.7/8Z.3	.1Z.3	.11/4Z.3
Safe-Lock™ Order No.	CC6.145...	-	-	-	-	.1/2Z.37	.5/8Z.37	.3/4Z.37	-	-	-
	Ø D2 [inch] ZG130	0.83		0.94		0.94	1.06	1.30			
	Ø D3 [inch] ZG130	2.09		2.09		2.09	2.09	2.09			
	L [inch] ZG130	1.42		1.65		1.65	1.97	1.97			
Gage length A [inch]	ZG130	5.12		5.12		5.12	5.12	5.12			
Order No.	CC6.144...	.1/4Z.3		.3/8Z.3		-	-	-			
Safe-Lock™ Order No.	CC6.144...	.1/4Z.37		.3/8Z.37		.1/2Z.37	.5/8Z.37	.3/4Z.37			

METRIC	Clamping Ø D1 [mm]	06	08	10	12	14	16	18	20	25	32
	Ø D2 [mm] ultra short	22	22	26.5	26.5	29.5	29.5	35.5	35.5	45	45
	Ø D3 [mm] ultra short	—	—	—	—	—	—	—	—	—	—
	L [mm] ultra short	38	38	43	46	48	51	51	53	60	65
Gage Length A [mm]	ultra short	65	65	65	65	70	70	70	70	80	80
Order No.	CC6.145...	.06.3	.08.3	.10.3	.12.3	.14.3	.16.3	.18.3	.20.3	.25.3	.32.3
Safe-Lock™ Order No.	CC6.145...	-	-	-	.12.37	-	.16.37	-	.20.37	-	-
	Ø D2 [mm] ZG130	21	21	24	24		27		33		
	Ø D3 [mm] ZG130	53	53	53	53		53		53		
	L [mm] ZG130	36	36	42	47		50		52		
Gage Length A [mm]	ZG130	130	130	130	130		130		130		
Order No.	CC6.144...	.06.3	.08.3	.10.3	.12.3		.16.3		.20.3		
Safe-Lock™ Order No.	CC6.144...	-	-	.10.37	.12.37		.16.37		.20.37		

Accessories

Cool Flash



Order No. 91.100.40

See page 182

COLLET CHUCK ER
HAIMER CAPTO™ C6 · ISO 26623

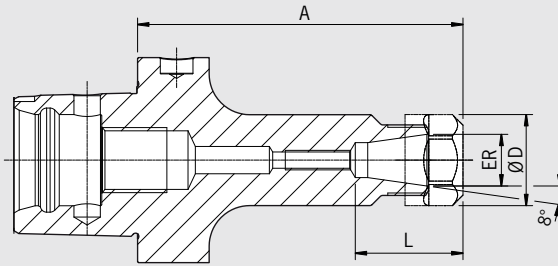

CERTIFICATE OF QUALITY	
<input checked="" type="checkbox"/>	Chuck body fine balanced G2.5 25,000 rpm or U<1 gmm
<input checked="" type="checkbox"/>	All functional surfaces machined
<input checked="" type="checkbox"/>	More accurate than DIN

For clamping cutters with cylindrical shanks in collets according to ISO 15488.
Available from ER 16 to 40.

ISO 26623

– Included in delivery: With locknut (balanced, with slide coating for higher clamping forces)

INCH	ER		16	20	25	32	40
	Ø D [inch]		1.1	1.34	1.65	1.97	2.48
	Clamping range [inch]		0.02–0.39	0.06–0.51	0.04–0.63	0.06–0.79	0.98–1.02
L [inch]			2) ²⁾	2) ²⁾	1.91	1.87	2.11
Gage length A [inch]	ultra short		2.36	2.36	2.36	2.36	2.56
Order No.	CC6.025...		.16 ¹⁾	.20 ¹⁾	.25 ¹⁾	.32 ¹⁾	.40 ¹⁾
L [inch]			1.30	1.54	1.63	1.87	2.11
Gage length A [inch]	long		3.94	3.94	3.94	3.94	3.94
Order No.	CC6.021...		.16	.20	.25	.32	.40
L [inch]			1.30	1.54	1.63	1.87	2.11
Gage length A [inch]	ZG1.30		5.12	5.12	5.12	5.12	5.12
Order No.	CC6.024...		.16	.20	.25	.32	.40
L [inch]			1.30	1.54	1.63	1.87	2.11
Gage length A [inch]	oversize		6.30	6.30	6.30	6.30	6.30
Order No.	CC6.022...		.16	.20	.25	.32	.40

	Collet Chuck Mini-ER		11	16
	Ø D1 [inch]		0.63	0.87
L [inch]			1.00	1.56
Gage length A [inch]	long		3.94	3.94
Order No.	CC6.021...		.11.7 ¹⁾	.16.7 ¹⁾
L [inch]			1.00	1.56
Gage length A [inch]	oversize		6.30	6.30
Order No.	CC6.022...		.11.7 ¹⁾	...16.7 ¹⁾

1) Without thread for back-up screw
2) Drilled through

POWER COLLET CHUCK
HAIMER CAPTO™ C6 · ISO 26623-1

CERTIFICATE OF QUALITY

- Chuck body fine balanced
G2.5 25,000 rpm or U<1 gmm
- All functional surfaces fine machined
- More accurate than DIN

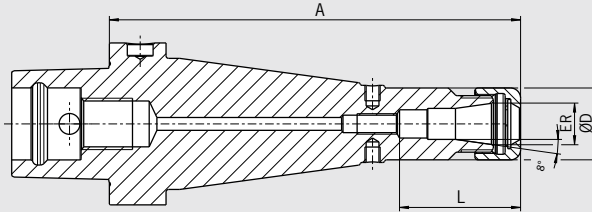

The Power Collet Chuck is designed for the highest machining capacity in high-speed manufacturing. The optimized design with improved construction combines high rigidity with vibration dampening features, giving more protection to the machine, spindle and tool. The universal Power Collet Chuck is a unique high performance chuck that can also be used with standard collets.

- TIR less than 0.00012" (3 µm) at 3×D with HAIMER Power Collets
- Also for standard collets ER according to ISO 15488 (Attention: By using standard collet ER length A will increase)
- High rigidity

- Runs smoother thanks to vibration absorbing geometry, yielding better surface finish and increased tool, spindle and machine protection
- Highest cutting performance with higher spindle speeds, higher feeds and larger cutting depths
- Shorter cycle times, higher machining accuracy, high clamping force
- Equally suited to high-speed manufacturing and heavy milling
- With threaded holes for balancing screws
- Optional: Cool-Jet bores on Power Collets from ER 25 Ø 1/4" (6 mm)
- Program of Power Collets on pages 154 – 157

INCH	ER	16	25	32
	∅ D [inch]	1.1	1.65	1.97
	Clamping range [inch]	1/8"-3/8"	1/8"-5/8"	1/8"-3/4"
	L [inch]	1.69	2.01	2.09
Gage length A [inch]	oversize	6.30	6.30	6.30
Order No.	CC6.024...	.16.3	.25.3	.32.3

Accessories

Locknut (fine-balanced)

Size	ER 16	ER 25	ER 32
Order No. 83.914...	.16	.25	.32

Clamping wrench  See page 158

Torque Master torque wrench for Power Collet Chucks  See page 158

Power Collets See page 154

Power Collets with Safe-Lock™ See page 156

Cool-Jet bores for Power Collets See page 157
 Order No. 91.100.27

WELDON TOOL HOLDER
HAIMER CAPTO™ C6 · ISO 26623

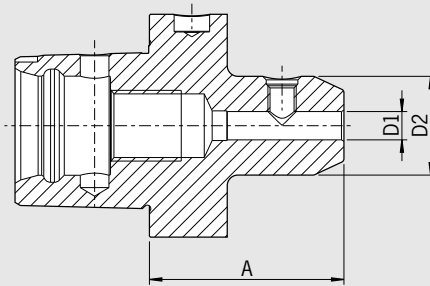

CERTIFICATE OF QUALITY	
<input checked="" type="checkbox"/>	Chuck fine balanced G2.5 25,000 rpm
<input checked="" type="checkbox"/>	All functional surfaces machined
<input checked="" type="checkbox"/>	More accurate than DIN

Use:

For clamping cutters with cylindrical shanks and Weldon flats according to DIN 1835-B and DIN 6935-HB.

From Ø 6 to Ø 40 mm.

- Interface with a unique tapered polygon and flange location face
- Exact positioning in the spindle
- Highest runout accuracy, torque and rigidity
- Innovative modular tool system with highest precision
- Suitable for both turning and milling centers

ISO 26623

- Included in delivery: with clamping screw

METRIC	Clamping Ø D1 [mm]	06	08	10	12	14	16	18	20	25	32	40
	Ø D2 [mm]	25	28	35	42	44	48	50	52	64	72	80
Gage length A [mm]	short	55	55	60	60	60	65	65	65	80	90	100
Order No.	CC6.000...	.06	.08	.10	.12	.14	.16	.18	.20	.25	.32	.40

Accessories

Clamping screw

Clamping Ø		06	08	10	12	14	16	18	20	25	32	40
Order No.	85.100...	.06	.08	.10	.12	.12	.14	.14	.16	.18	.20	.25

Balancing index rings

Clamping Ø	long/oversize	06	08	10	12	14	16	18	20	25	32	40
Order No.	79.350...	.25	.28	.35	.42	.44	.48	.50	.52	.64	.72	.80

Cool-Jet bores from Ø 6 mm – Ø 20 mm												
Order No.	91.100.24											

Cool-Jet bores from Ø 25 mm – Ø 32 mm												
Order No.	91.100.26											

FACE MILL ARBOR
HAIMER CAPTO™ C6 · ISO 26623

CERTIFICATE OF QUALITY

- Chuck body fine balanced
G2.5 25,000 rpm
- All functional surfaces machined
- More accurate than DIN

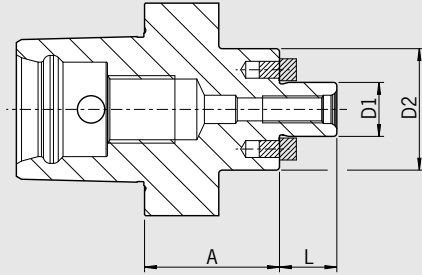

Use:

- For clamping face mill cutters and cutters with radial driving slot DIN 1880.
- Interface with a unique tapered polygon and flange location face
 - Exact positioning in the spindle
 - Highest runout accuracy, torque and rigidity
 - Innovative modular tool system with highest precision
 - Suitable for both turning and milling centers

ISO 26623

- Included in delivery: tightening bolt
- With coolant exit bores on the end face for milling cutters with central cooling

METRIC	Clamping Ø D1 [mm]	16	22	27	32	40
	Ø D2 [mm]	36	48	60	63	70
	L [mm]	17	19	21	24	27
Gage length A [mm]	short	40	25	25	25	40
Order No.	CC6.050...	.16.KKB	.22.KKB	.27.KKB	.32.KKB	.40.KKB

Accessories

Tightening bolt

Size D1		16	22	27	32	40
Order No.	85.300...	.16	.22	.27	.32	.40

Wrench

Size D1		16	22	27	32	40
Order No.	84.400...	.16	.22	.27	.32	.40

Balancing index rings

Size D1		16
Order No.	79.350...	.36

Coolant bores

Order No.	91.100.03
-----------	-----------

HAIMER Power Clamp:

Reliable shrinking –
Fastest in the galaxy.

HAIMER®
Quality Wins.



Shrinking Technology

Tooling Technology

Balancing Technology

Measuring Instruments

Haimer USA, LLC | 134 E. Hill Street | Villa Park, IL 60181
Phone: +1-630-833-1500 | Email: haimer@haimer-usa.com | www.haimer-usa.com

Accessories



<u>Shrink Fit Extensions</u>	144
<u>Mini Shrink Extensions</u>	145
<u>HG Mini Extensions</u>	146
<u>Heavy Duty Shrink Extensions</u>	147
<u>ER Collets</u>	148
<u>ER Collets - sealed</u>	151
<u>Collets for Power Collet Chuck</u>	154
<u>Power Collets with Safe-Lock™</u>	156
<u>Cool-Jet bores for Power Collet</u>	157
<u>Power Collet Torque Master</u>	158
<u>Power Collet inserts for Torque Master</u>	159
<u>HG Collets & HG Spindle wiper</u>	160
<u>Tool Clamp</u>	161
<u>Pull Studs</u>	162
<u>Reduction Sleeves</u>	165
<u>Balancing Index Rings</u>	166
<u>Coolant Tubes</u>	167
<u>Tension springs</u>	168
<u>Shrink Fit Brush</u>	169
<u>Backup screws</u>	170
<u>Spindle wipers</u>	172

SHRINK FIT EXTENSION

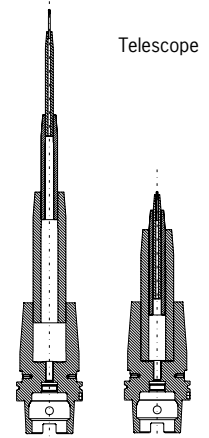
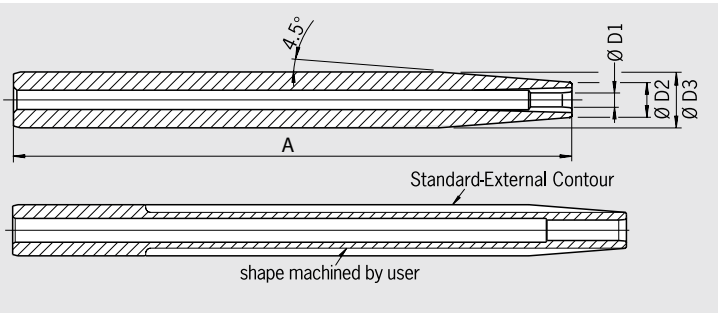

The universal solution for your machining issues

- Highest runout accuracy
- Optimal and nearly unlimited extensions possible
- Versatile to use and always re-usable
- The most economic way for special machining requirements
- For carbide steel and HSS shanks
- Delivery without cooling adapter

- Telescope version (drilled through, without back-up screw)
- For shank tolerance h6

INCH		Ø D3	Ø D2	Clamping Ø D1	Gage length A	Cooling body	Adapter
Order No.	78.1/2Z0.1/8Z.2	1/2"	0.31"	1/8"	6.30"	Ø 14-16	80.105.14.1.1
Order No.	78.1/2Z0.3/16Z.2	1/2"	0.31"	3/16"	6.30"	Ø 14-16	80.105.14.1.1
Order No.	78.5/8Z0.1/8Z.2	5/8"	0.39"	1/8"	6.30"	Ø 14-16	80.105.14.1.1
Order No.	78.5/8Z0.3/16Z.2	5/8"	0.39"	3/16"	6.30"	Ø 14-16	80.105.14.1.1
Order No.	78.5/8Z0.1/4Z.1	5/8"	0.39"	1/4"	6.30"	Ø 14-16	80.105.14.1.1
Order No.	78.3/4Z0.1/4Z.1	3/4"	0.55"	1/4"	6.30"	Ø 14-16	80.105.14.1.2
Order No.	78.3/4Z0.3/8Z.1	3/4"	0.55"	3/8"	6.30"	Ø 14-16	80.105.14.1.2
Order No.	78.1Z0.3/8Z.1	1"	0.79"	3/8"	6.30"	Ø 6-8	-
Order No.	78.1Z0.1/2Z.1	1"	0.79"	1/2"	6.30"	Ø 6-8	-
Order No.	78.1Z0.5/8Z.1	1"	0.87"	5/8"	6.30"	Ø 10-12	-
Order No.	78.11/4Z0.3/8Z.1	1 1/4"	0.94"	3/8"	6.30"	Ø 14-16	-
Order No.	78.11/4Z0.1/2Z.1	1 1/4"	0.94"	1/2"	6.30"	Ø 14-16	-
Order No.	78.11/4Z0.5/8Z.1	1 1/4"	1.06"	5/8"	6.30"	Ø 14-16	-

METRIC [mm]		Ø D3	Ø D2	Clamping Ø D1	Gage length A	Cooling body	Adapter
Order No.	78.120.03.2	12	8	3	160	Ø 14-16	80.105.14.1.1
Order No.	78.120.04.2	12	8	4	160	Ø 14-16	80.105.14.1.1
Order No.	78.160.03.2	16	10	3	160	Ø 14-16	80.105.14.1.1
Order No.	78.160.04.2	16	10	4	160	Ø 14-16	80.105.14.1.1
Order No.	78.160.05.2	16	10	5	160	Ø 14-16	80.105.14.1.1
Order No.	78.160.06.1	16	10	6	160	Ø 14-16	80.105.14.1.1
Order No.	78.200.05.2	20	14	5	160	Ø 14-16	80.105.14.1.2
Order No.	78.200.06.1	20	14	6	160	Ø 14-16	80.105.14.1.2
Order No.	78.200.08.1	20	14	8	160	Ø 14-16	80.105.14.1.2
Order No.	78.250.08.1	25	19	8	160	Ø 6-8	-
Order No.	78.250.10.1	25	20	10	160	Ø 6-8	-
Order No.	78.250.12.1	25	20	12	160	Ø 6-8	-
Order No.	78.250.14.1	25	20	14	160	Ø 6-8	-
Order No.	78.250.16.1	25	22	16	160	Ø 10-12	-
Order No.	78.320.10.1	32	24	10	160	Ø 14-16	-
Order No.	78.320.12.1	32	24	12	160	Ø 14-16	-
Order No.	78.320.14.1	32	27	14	160	Ø 14-16	-
Order No.	78.320.16.1	32	27	16	160	Ø 14-16	-
Order No.	78.320.20.1	32	27	20	160	Ø 14-16	-

The external contour of the shrinking extensions can be modified later as required

Technical data and availability subject to change without prior notice

MINI SHRINK EXTENSION

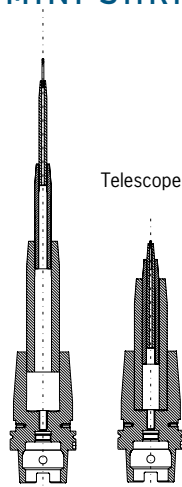

– It is imperative that the correct adapter be used for both heating and cooling with all “Mini Shrink” chucks, in order to prevent overheating of the chuck.

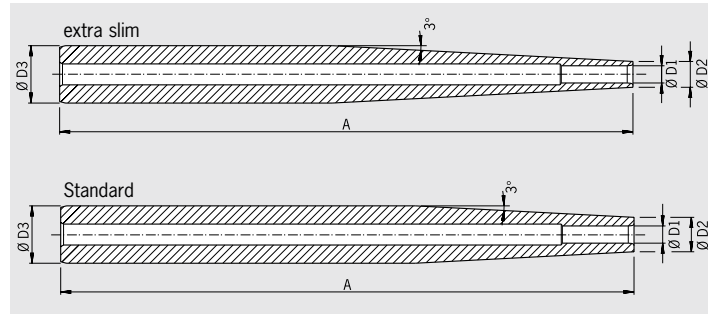

- Extreme slim design
- No disturbing edges
- Ideal for the HAIMER Power Clamp
- For all solid carbide tools with shank tolerance h6
- With 3° slope for dies and molds

- **Standard version:** with higher clamping forces
 - **Extra slim version:** extremely slim for fine machining and for jobs very difficult to reach
- Attention:** Heating and cooling only with shrink and cooling sleeves (see accessories)

Standard version Order No.	Length A [inch]	Outer Ø D3 [inch]	Shank tolerance	Clamping Ø D1 [inch]	Ø D2 [inch]	Cooling body	Adapter
77.5/822.1/8Z	6.30"	5/8"	h6	1/8"	0.35"	Ø 6–8	80.105.14.2.04
77.5/822.3/16Z	6.30"	5/8"	h6	3/16"	0.43"	Ø 6–8	80.105.14.2.05
77.5/822.1/4Z ¹⁾	6.30"	5/8"	h6	1/4"	0.47"	Ø 6–8	80.105.14.2.09
77.5/822.3/8Z ¹⁾	6.30"	5/8"	h6	3/8"	0.63"	Ø 6–8	80.105.14.2.11
77.3/422.1/4Z	7.87"	3/4"	h6	1/4"	0.47"	Ø 6–8	80.105.14.2.09
77.3/422.3/8Z	7.87"	3/4"	h6	3/8"	0.63"	Ø 6–8	80.105.14.2.11
77.3/422.1/2Z	7.87"	3/4"	h6	1/2"	0.71"	Ø 6–8	80.105.14.2.12
Extra slim							
77.5/820.1/8Z	6.30"	5/8"	h6	1/8"	0.24"	Ø 6–8	80.105.14.2.01
77.5/820.3/16Z	6.30"	5/8"	h6	3/16"	0.32"	Ø 6–8	80.105.14.2.03
77.5/820.1/4Z ¹⁾	6.30"	5/8"	h6	1/4"	0.35"	Ø 6–8	80.105.14.2.04
77.5/820.3/8Z ¹⁾	6.30"	5/8"	h6	3/8"	0.51"	Ø 6–8	80.105.14.2.06
77.3/420.1/4Z	7.87"	3/4"	h6	1/4"	0.35"	Ø 6–8	80.105.14.2.04
77.3/420.3/8Z	7.87"	3/4"	h6	3/8"	0.51"	Ø 6–8	80.105.14.2.06
77.3/420.1/2Z	7.87"	3/4"	h6	1/2"	0.59"	Ø 6–8	80.105.14.2.07

Standard version Order No.	Length A [mm]	Outer Ø D3 [mm]	Shank tolerance	Clamping Ø D1 [mm]	Ø D2 [mm]	Cooling body	Adapter
77.162.03	160	16	h6	3	9	Ø 6–8	80.105.14.2.04
77.162.04	160	16	h6	4	10	Ø 6–8	80.105.14.2.08
77.162.05	160	16	h6	5	11	Ø 6–8	80.105.14.2.05
77.162.06 ¹⁾	160	16	h6	6	12	Ø 6–8	80.105.14.2.09
77.162.08 ¹⁾	160	16	h6	8	14	Ø 6–8	80.105.14.2.10
77.162.10 ¹⁾	160	16	h6	10	16	Ø 6–8	80.105.14.2.11
77.202.06	200	20	h6	6	12	Ø 6–8	80.105.14.2.09
77.202.08	200	20	h6	8	14	Ø 6–8	80.105.14.2.10
77.202.10	200	20	h6	10	16	Ø 6–8	80.105.14.2.11
77.202.12	200	20	h6	12	18	Ø 6–8	80.105.14.2.12
Extra slim							
77.160.03	160	16	h6	3	6	Ø 6–8	80.105.14.2.01
77.160.04	160	16	h6	4	7	Ø 6–8	80.105.14.2.02
77.160.05	160	16	h6	5	8	Ø 6–8	80.105.14.2.03
77.160.06 ¹⁾	160	16	h6	6	9	Ø 6–8	80.105.14.2.04
77.160.08 ¹⁾	160	16	h6	8	11	Ø 6–8	80.105.14.2.05
77.160.10 ¹⁾	160	16	h6	10	13	Ø 6–8	80.105.14.2.06
77.200.06	200	20	h6	6	9	Ø 6–8	80.105.14.2.04
77.200.08	200	20	h6	8	11	Ø 6–8	80.105.14.2.05
77.200.10	200	20	h6	10	13	Ø 6–8	80.105.14.2.06
77.200.12	200	20	h6	12	15	Ø 6–8	80.105.14.2.07

1) With adjustment screw



HG Mini 01
cylindrical

HG Mini 01
conical

HG Mini 02
cylindrical

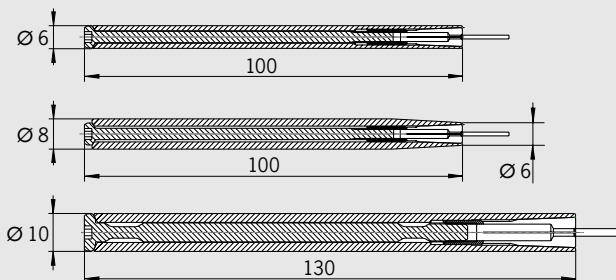

	HG Mini 01 cylindrical	HG Mini 01 conical	HG Mini 02 cylindrical
Size	A = 100 mm	A = 100 mm	A = 130 mm
Outer diam.	6 mm cylindrical	6–8 mm conical	10 mm cylindrical
Clamping range Ø	1–2.5 mm	1–2.5 mm	2.5–4.5 mm
Order No.	82.611.01	82.621.01	82.610.02

Collets for HG Mini 01

Clamping	Ø D [mm]	1	1.5	2	2.5
Order No.	82.650...	.010	.015	.020	.025

Collets for HG Mini 02

Clamping	Ø D [mm]	2	2.5	3	3.5	4	4.5
Order No.	82.660...	.020	.025	.030	.035	.040	.045



HG Mini with torque wrench and assembly device



Assembly device for HG Mini

Accessories

Torque wrench for HG Mini (pre-adjusted)

Size	01	02
Order No.	82.576.00	82.577.00
Assembly device for HG Mini		
Order No.	82.578.00	

HEAVY DUTY SHRINK FIT EXTENSIONS

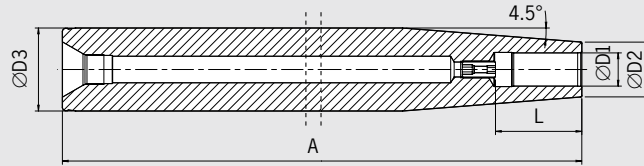

CERTIFICATE OF QUALITY

- All functional surfaces machined
- More accurate than DIN

Heavy Duty Shrink Fit Extensions

- HAIMER is a full system provider: The next addition to the Heavy Duty Chucks
- Extremely stable with 50 mm outer diameter
- Safe support of the tool with set screws
- Heavy machining also in hidden angles: Lengths of 400 and 600 mm
- The extensions can be shortened to customer's needs on request
- Solid carbide inserts for vibration dampening on request

Heavy Duty Shrink Fit Extensions without solid carbide core

METRIC	Clamping Ø D1 [mm]	16	20	25
	Ø D2 [mm]	27	33	44
	Ø D3 [mm]	50	50	50
	L [mm]	50	52	58
Gage length A [mm]	oversize	400	400	400
Order No.	78.502...	.16	.20	.25
Gage length A [mm]	ZG600	600	600	600
Order No.	78.506...	.16	.20	.25

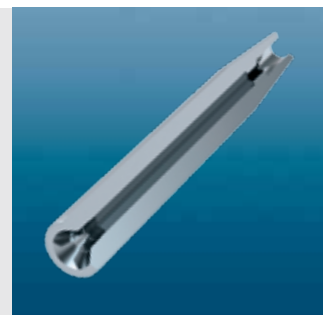
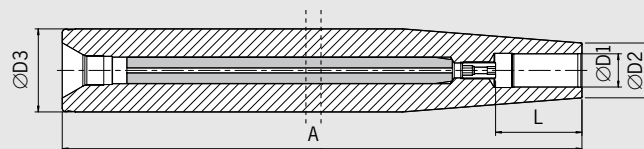

CERTIFICATE OF QUALITY

- All functional surfaces machined
- More accurate than DIN

Heavy Duty Shrink Fit Extensions with solid carbide core

METRIC	Clamping Ø D1 [mm]	16	20	25
	Ø D2 [mm]	27	33	44
	Ø D3 [mm]	50	50	50
	L [mm]	50	52	58
Gage length A [mm]	oversize	400	400	400
Order No.	78.502...	.16.9	.20.9	.25.9
Gage length A [mm]	ZG600	600	600	600
Order No.	78.506...	.16.9	.20.9	.25.9

HIGH PRECISION ER COLLETS
METRIC

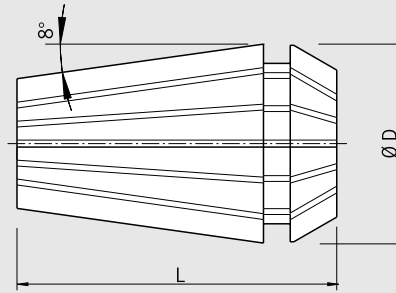

- Guaranteed 5 µm maximum runout or better, when measured at 3 times the tool diameter.
- ISO 15488
- High polished finish for improved accuracy
- Superior clamping strength
- Fits all brands of ER collet chucks

ER 11 Clamping Ø		[mm]	Ø D	L
Order No.	81.110.1.0	0.50 ... 1.00	11.5	18
	81.110.1.5	1.00 ... 1.50	11.5	18
	81.110.2.0	1.50 ... 2.00	11.5	18
	81.110.2.5	2.00 ... 2.50	11.5	18
	81.110.3.0	2.50 ... 3.00	11.5	18
	81.110.3.5	3.00 ... 3.50	11.5	18
	81.110.4.0	3.50 ... 4.00	11.5	18
	81.110.4.5	4.00 ... 4.50	11.5	18
	81.110.5.0	4.50 ... 5.00	11.5	18
	81.110.5.5	5.00 ... 5.50	11.5	18
	81.110.6.0	5.50 ... 6.00	11.5	18
	81.110.6.5	6.00 ... 6.50	11.5	18
	81.110.7.0	6.50 ... 7.00	11.5	18

ER 16 Clamping Ø		[mm]	Ø D	L
Order No.	81.160.01	0.50 ... 1.00	17	27
	81.160.1.5	1.00 ... 1.50	17	27
	81.160.2.0	1.50 ... 2.00	17	27
	81.160.2.5	2.00 ... 2.50	17	27
	81.160.3.0	2.50 ... 3.00	17	27
	81.160.4.0	3.00 ... 4.00	17	27
	81.160.5.0	4.00 ... 5.00	17	27
	81.160.6.0	5.00 ... 6.00	17	27
	81.160.7.0	6.00 ... 7.00	17	27
	81.160.8.0	7.00 ... 8.00	17	27
	81.160.9.0	8.00 ... 9.00	17	27
	81.160.10	9.00 ... 10.00	17	27

ER 20 Clamping Ø		[mm]	Ø D	L
Order No.	81.200.02	1.50 ... 2.00	21	31.5
	81.200.03	2.00 ... 3.00	21	31.5
	81.200.04	3.00 ... 4.00	21	31.5
	81.200.05	4.00 ... 5.00	21	31.5
	81.200.06	5.00 ... 6.00	21	31.5
	81.200.07	6.00 ... 7.00	21	31.5
	81.200.08	7.00 ... 8.00	21	31.5
	81.200.09	8.00 ... 9.00	21	31.5
	81.200.10	9.00 ... 10.00	21	31.5
	81.200.11	10.00 ... 11.00	21	31.5
	81.200.12	11.00 ... 12.00	21	31.5
	81.200.13	12.00 ... 13.00	21	31.5

ER 25 Clamping Ø		[mm]	Ø D	L
Order No.	81.250.1.5	1.00 ... 1.50	26	35
	81.250.02	1.50 ... 2.00	26	35
	81.250.2.5	2.00 ... 2.50	26	35
	81.250.03	2.50 ... 3.00	26	35
	81.250.04	3.00 ... 4.00	26	35
	81.250.05	4.00 ... 5.00	26	35
	81.250.06	5.00 ... 6.00	26	35
	81.250.07	6.00 ... 7.00	26	35
	81.250.08	7.00 ... 8.00	26	35
	81.250.09	8.00 ... 9.00	26	35
	81.250.10	9.00 ... 10.00	26	35
	81.250.11	10.00 ... 11.00	26	35
	81.250.12	11.00 ... 12.00	26	35
	81.250.13	12.00 ... 13.00	26	35
	81.250.14	13.00 ... 14.00	26	35
	81.250.15	14.00 ... 15.00	26	35
	81.250.16	15.00 ... 16.00	26	35

HIGH PRECISION ER COLLETS METRIC

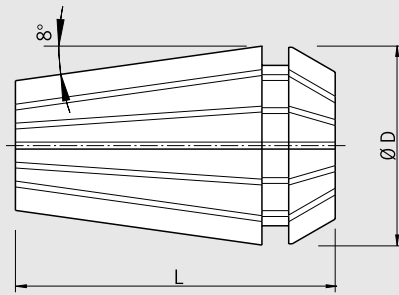

- Guaranteed 5 µm maximum runout or better, when measured at 3 times the tool diameter.
- ISO 15488
- High polished finish for improved accuracy
- Superior clamping strength
- Fits all brands of ER collet chucks

ER 32 Clamping Ø		[mm]	Ø D	L
Order No.	81.320.02	1.50 ... 2.00	33	40
	81.320.25	2.00 ... 2.50	33	40
	81.320.03	2.50 ... 3.00	33	40
	81.320.04	3.00 ... 4.00	33	40
	81.320.05	4.00 ... 5.00	33	40
	81.320.06	5.00 ... 6.00	33	40
	81.320.07	6.00 ... 7.00	33	40
	81.320.08	7.00 ... 8.00	33	40
	81.320.09	8.00 ... 9.00	33	40
	81.320.10	9.00 ... 10.00	33	40
	81.320.11	10.00 ... 11.00	33	40
	81.320.12	11.00 ... 12.00	33	40
	81.320.13	12.00 ... 13.00	33	40
	81.320.14	13.00 ... 14.00	33	40
	81.320.15	14.00 ... 15.00	33	40
	81.320.16	15.00 ... 16.00	33	40
	81.320.17	16.00 ... 17.00	33	40
	81.320.18	17.00 ... 18.00	33	40
	81.320.19	18.00 ... 19.00	33	40
	81.320.20	19.00 ... 20.00	33	40

ER 40 Clamping Ø		[mm]	Ø D	L
Order No.	81.400.03	2.50 ... 3.00	41	46
	81.400.04	3.00 ... 4.00	41	46
	81.400.05	4.00 ... 5.00	41	46
	81.400.06	5.00 ... 6.00	41	46
	81.400.07	6.00 ... 7.00	41	46
	81.400.08	7.00 ... 8.00	41	46
	81.400.09	8.00 ... 9.00	41	46
	81.400.10	9.00 ... 10.00	41	46
	81.400.11	10.00 ... 11.00	41	46
	81.400.12	11.00 ... 12.00	41	46
	81.400.13	12.00 ... 13.00	41	46
	81.400.14	13.00 ... 14.00	41	46
	81.400.15	14.00 ... 15.00	41	46
	81.400.16	15.00 ... 16.00	41	46
	81.400.17	16.00 ... 17.00	41	46
	81.400.18	17.00 ... 18.00	41	46
	81.400.19	18.00 ... 19.00	41	46
	81.400.20	19.00 ... 20.00	41	46
	81.400.21	20.00 ... 21.00	41	46
	81.400.22	21.00 ... 22.00	41	46
	81.400.23	22.00 ... 23.00	41	46
	81.400.24	23.00 ... 24.00	41	46
	81.400.25	24.00 ... 25.00	41	46
	81.400.26	25.00 ... 26.00	41	46

HIGH PRECISION ER COLLETS
INCH

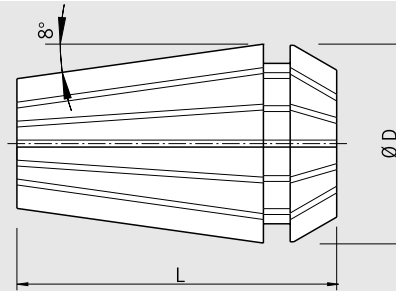

- Guaranteed 0.0002" maximum runout or better, when measured at 3 times the tool diameter.
- ISO 15488
- High polished finish for improved accuracy
- Superior clamping strength
- Fits all brands of ER collet chucks

ER 16 Clamping Ø		[inch]	Ø D	L
Order No.	81.160.1/16Z	0.0425 – 0.0625	0.67	1.06
	81.160.1/8Z	0.085 – 0.125	0.67	1.06
	81.160.3/16Z	0.1475 – 0.1875	0.67	1.06
	81.160.1/4Z	0.21 – 0.25	0.67	1.06
	81.160.5/16Z	0.2725 – 0.3125	0.67	1.06
	81.160.3/8Z	0.335 – 0.375	0.67	1.06

ER 20 Clamping Ø		[inch]	Ø D	L
Order No.	81.200.1/8Z	0.085 – 0.125	0.83	1.24
	81.200.3/16Z	0.1475 – 0.1875	0.83	1.24
	81.200.1/4Z	0.21 – 0.25	0.83	1.24
	81.200.5/16Z	0.2725 – 0.3125	0.83	1.24
	81.200.3/8Z	0.335 – 0.375	0.83	1.24
	81.200.7/16Z	0.3975 – 0.4375	0.83	1.24
	81.200.1/2Z	0.46 – 0.50	0.83	1.24

ER 25 Clamping Ø		[inch]	Ø D	L
Order No.	81.250.1/8Z	0.085 – 0.125	1.02	1.38
	81.250.3/16Z	0.1475 – 0.1875	1.02	1.38
	81.250.1/4Z	0.21 – 0.25	1.02	1.38
	81.250.5/16Z	0.2725 – 0.3125	1.02	1.38
	81.250.3/8Z	0.335 – 0.375	1.02	1.38
	81.250.7/16Z	0.3975 – 0.4375	1.02	1.38
	81.250.1/2Z	0.46 – 0.50	1.02	1.38
	81.250.9/16Z	0.5225 – 0.5625	1.02	1.38
	81.250.5/8Z	0.585 – 0.625	1.02	1.38

ER 32 Clamping Ø		[inch]	Ø D	L
Order No.	81.320.1/8Z	0.085 – 0.125	1.3	1.57
	81.320.3/16Z	0.1475 – 0.1875	1.3	1.57
	81.320.1/4Z	0.21 – 0.25	1.3	1.57
	81.320.5/16Z	0.2725 – 0.3125	1.3	1.57
	81.320.3/8Z	0.335 – 0.375	1.3	1.57
	81.320.7/16Z	0.3975 – 0.4375	1.3	1.57
	81.320.1/2Z	0.46 – 0.50	1.3	1.57
	81.320.9/16Z	0.5225 – 0.5625	1.3	1.57
	81.320.5/8Z	0.585 – 0.625	1.3	1.57
	81.320.11/16Z	0.6475 – 0.6875	1.3	1.57
	81.320.3/4Z	0.71 – 0.75	1.3	1.57

ER 40 Clamping Ø		[inch]	Ø D	L
Order No.	81.400.1/4Z	0.21 – 0.25	1.61	1.81
	81.400.5/16Z	0.2725 – 0.3125	1.61	1.81
	81.400.3/8Z	0.335 – 0.375	1.61	1.81
	81.400.7/16Z	0.3975 – 0.4375	1.61	1.81
	81.400.1/2Z	0.46 – 0.50	1.61	1.81
	81.400.9/16Z	0.5225 – 0.5625	1.61	1.81
	81.400.5/8Z	0.585 – 0.625	1.61	1.81
	81.400.3/4Z	0.71 – 0.75	1.61	1.81
	81.400.7/8Z	0.835 – 0.875	1.61	1.81
	81.400.1Z	0.96 – 1	1.61	1.81

HIGH PRECISION ER COLLETS – SEALED METRIC

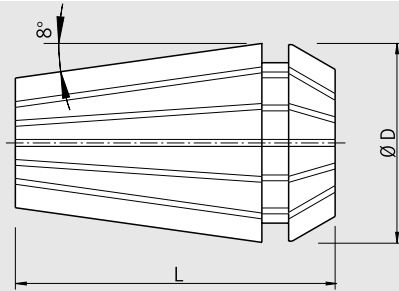

- High polished finish for extra accuracy and long life, especially when clamped in HAIMER ER chucks
- ISO 15488 (formerly DIN 6499)
- Superior clamping strength
- Fits all brands of ER holders
- Runout accuracy 5 µm
- Sealed for internal coolant tools

ER 16 Clamping Ø		[mm]	Ø D	L
Order No.	81.165.03	03	16.70	30
	81.165.04	04	16.70	30
	81.165.05	05	16.70	30
	81.165.06	06	16.70	30
	81.165.07	07	16.70	30
	81.165.08	08	16.70	30
	81.165.09	09	16.70	30
	81.165.10	10	16.70	30

ER 20 Clamping Ø		[mm]	Ø D	L
Order No.	81.205.03	03	20.70	30
	81.205.04	04	20.70	30
	81.205.05	05	20.70	30
	81.205.06	06	20.70	30
	81.205.07	07	20.70	30
	81.205.08	08	20.70	30
	81.205.09	09	20.70	30
	81.205.10	10	20.70	30
	81.205.11	11	20.70	30
	81.205.12	12	20.70	30

ER 25 Clamping Ø		[mm]	Ø D	L
Order No.	81.255.03	03	25.70	37
	81.255.04	04	25.70	37
	81.255.05	05	25.70	37
	81.255.06	06	25.70	37
	81.255.07	07	25.70	37
	81.255.08	08	25.70	37
	81.255.09	09	25.70	37
	81.255.10	10	25.70	37
	81.255.11	11	25.70	37
	81.255.12	12	25.70	37
	81.255.13	13	25.70	37
	81.255.14	14	25.70	37
	81.255.15	15	25.70	37
	81.255.16	16	25.70	37

ER 32 Clamping Ø		[mm]	Ø D	L
Order No.	81.325.03	03	32.70	45
	81.325.04	04	32.70	45
	81.325.05	05	32.70	45
	81.325.06	06	32.70	45
	81.325.07	07	32.70	45
	81.325.08	08	32.70	45
	81.325.09	09	32.70	45
	81.325.10	10	32.70	45
	81.325.11	11	32.70	45
	81.325.12	12	32.70	45
	81.325.13	13	32.70	45
	81.325.14	14	32.70	45
	81.325.15	15	32.70	45
	81.325.16	16	32.70	45
	81.325.17	17	32.70	45
	81.325.18	18	32.70	45
	81.325.19	19	32.70	45
	81.325.20	20	32.70	45

ER 40 Clamping Ø		[mm]	Ø D	L
Order No.	81.405.06	06	40.70	30
	81.405.08	08	40.70	30
	81.405.10	10	40.70	30
	81.405.12	12	40.70	30
	81.405.14	14	40.70	30
	81.405.16	16	40.70	30
	81.405.18	18	40.70	30
	81.405.20	20	40.70	30
	81.405.22	22	40.70	30
	81.405.25	25	40.70	30

HIGH PRECISION ER COLLETS - SEALED INCH

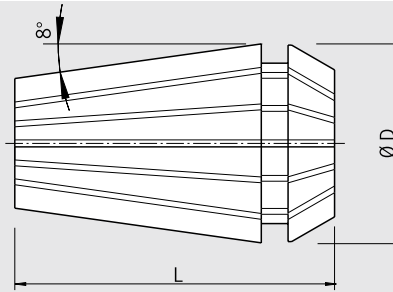

- High polished finish for extra accuracy and long life, especially when clamped in HAIMER ER chucks
- ISO 15488 (formerly DIN 6499)
- Superior clamping strength
- Fits all brands of ER holders
- Runout accuracy 5 µm
- Sealed for internal coolant tools

ER 16 Clamping Ø		[inch]	Ø D	L
Order No.	81.165.1/8z	1/8	0.65	1.18
	81.165.3/16z	3/16	0.65	1.18
	81.165.1/4z	1/4	0.65	1.18
	81.165.5/16z	5/16	0.65	1.18
	81.165.3/8z	3/8	0.65	1.18

ER 20 Clamping Ø		[inch]	Ø D	L
Order No.	81.205.1/8z	1/8	1.001	1.46
	81.205.3/16z	3/16	1.001	1.46
	81.205.1/4z	1/4	1.001	1.46
	81.205.5/16z	5/16	1.001	1.46
	81.205.3/8z	3/8	1.001	1.46
	81.205.7/16z	7/16	1.001	1.46
	81.205.1/2z	1/2	1.001	1.46

ER 25 Clamping Ø		[inch]	Ø D	L
Order No.	81.255.1/8z	1/8	1.001	1.46
	81.255.3/16z	3/16	1.001	1.46
	81.255.1/4z	1/4	1.001	1.46
	81.255.5/16z	5/16	1.001	1.46
	81.255.3/8z	3/8	1.001	1.46
	81.255.7/16z	7/16	1.001	1.46
	81.255.1/2z	1/2	1.001	1.46
	81.255.9/16z	9/16	1.001	1.46
	81.255.5/8z	5/8	1.001	1.46

ER 32 Clamping Ø		[inch]	Ø D	L
Order No.	81.325.1/8z	1/8	1.28	1.77
	81.325.3/16z	3/16	1.28	1.77
	81.325.1/4z	1/4	1.28	1.77
	81.325.5/16z	5/16	1.28	1.77
	81.325.3/8z	3/8	1.28	1.77
	81.325.7/16z	7/16	1.28	1.77
	81.325.1/2z	1/2	1.28	1.77
	81.325.9/16z	9/16	1.28	1.77
	81.325.5/8z	5/8	1.28	1.77
	81.325.3/4z	3/4	1.28	1.77

HIGH PRECISION COLLETS ER – SEALED WITH COOL-JET

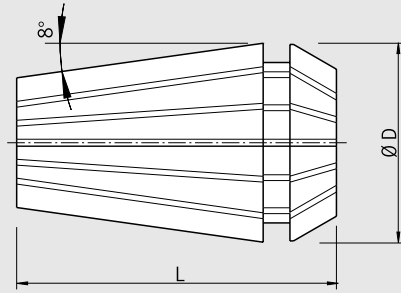

- High polished finish for extra accuracy and long life, especially when clamped in HAIMER ER chucks
- ISO 15488 (formerly DIN 6499)
- Superior clamping strength
- Fits all brands of ER holders
- Runout accuracy 3 µm
- Shank must be h8 or better

- For cylindrical shanks with tolerance h8
- With Cool-Jet bores for optimal coolant supply

ER 25 Clamping Ø		[mm]	Ø D	L
Order No.	81.252.04	04	26	37
	81.252.06	06	26	37
	81.252.08	08	26	37
	81.252.10	10	26	37
	81.252.12	12	26	37
	81.252.14	14	26	37

ER 32 Clamping Ø		[mm]	Ø D	L
Order No.	81.322.04	04	33	45
	81.322.06	06	33	45
	81.322.08	08	33	45
	81.322.10	10	33	45
	81.322.12	12	33	45
	81.322.14	14	33	45
	81.322.16	16	33	45
	81.322.18	18	33	45

Attention: Blue plastic ring is for identification purposes only and must be removed before use.

POWER COLLET FOR HAIMER POWER COLLET CHUCK
INCH

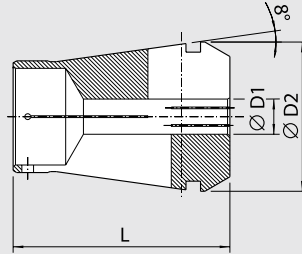

Power ER Collet

- For ultra precision machining
- High runout accuracy (0.003 mm at 3×D)

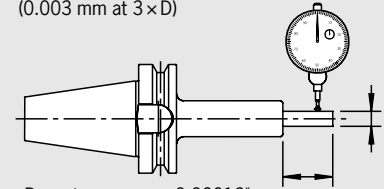

Runout accuracy < 0.00012"

- High runout accuracy: < 0.00012" (3µm) at 3×D
- Superior clamping strength
- Fits HAIMER Power Collet Chucks
- For cylindrical shanks with tolerance h10
- Optional: Cool-Jet bores from diam. 1/4" in ER 25 and ER 32

ER 16	Clamping	Ø D1 [inch]	Ø D2 [inch]	L [inch]
Order No.	81.163.1/8z	1/8	0.65	1.18
	81.163.3/16z	3/16	0.65	1.18
	81.163.1/4z ¹⁾	1/4	0.65	1.18
	81.163.5/16z ¹⁾	5/16	0.65	1.18
	81.163.3/8z ¹⁾	3/8	0.65	1.18

ER 25	Clamping	Ø D1 [inch]	Ø D2 [inch]	L [inch]
Order No.	81.253.1/8z	1/8	1.001	1.46
	81.253.3/16z	3/16	1.001	1.46
	81.253.1/4z ¹⁾	1/4	1.001	1.46
	81.253.5/16z ¹⁾	5/16	1.001	1.46
	81.253.3/8z ¹⁾	3/8	1.001	1.46
	81.253.7/16z ¹⁾	7/16	1.001	1.46
	81.253.1/2z ¹⁾	1/2	1.001	1.46
	81.253.9/16z ¹⁾	9/16	1.001	1.46
	81.253.5/8z ¹⁾	5/8	1.001	1.46

ER 32	Clamping	Ø D1 [inch]	Ø D2 [inch]	L [inch]
Order No.	81.323.1/8z	1/8	1.28	1.77
	81.323.3/16z	3/16	1.28	1.77
	81.323.1/4z	1/4 ¹⁾	1.28	1.77
	81.323.5/16z	5/16 ¹⁾	1.28	1.77
	81.323.3/8z	3/8 ¹⁾	1.28	1.77
	81.323.7/16z	7/16 ¹⁾	1.28	1.77
	81.323.1/2z	1/2 ¹⁾	1.28	1.77
	81.323.9/16z	9/16 ¹⁾	1.28	1.77
	81.323.5/8z	5/8 ¹⁾	1.28	1.77
	81.323.3/4z	3/4 ¹⁾	1.28	1.77

1) Sealed for internal coolant

POWER COLLET FOR HAIMER POWER COLLET CHUCK METRIC

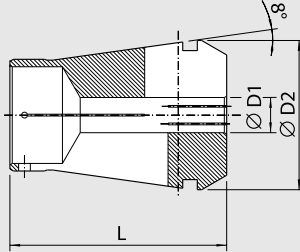

- High runout accuracy: < 0.00012" (3µm) at 3×D
- Superior clamping strength
- Fits HAIMER Power Collet Chucks
- For cylindrical shanks with tolerance h10
- Optional: Cool-Jet bores from Ø 6 mm at ER25 and ER 32

ER 16 Clamping Ø [mm]		D1	D2	L
Order No.	81.163.02	2	16.45	30
	81.163.03	3	16.45	30
	81.163.04	4	16.45	30
	81.163.05	5	16.45	30
	81.163.06¹⁾	6	16.45	30
	81.163.08¹⁾	8	16.45	30
	81.163.10¹⁾	10	16.45	30

ER 25 Clamping Ø [mm]		D1	D2	L
Order No.	81.253.02	2	25.45	37
	81.253.03	3	25.45	37
	81.253.04	4	25.45	37
	81.253.05	5	25.45	37
	81.253.06¹⁾	6	25.45	37
	81.253.08¹⁾	8	25.45	37
	81.253.10¹⁾	10	25.45	37
	81.253.12¹⁾	12	25.45	37
	81.253.14¹⁾	14	25.45	37
	81.253.16¹⁾	16	25.45	37

ER 32 Clamping Ø [mm]		D1	D2	L
Order No.	81.323.02	2	32.48	45
	81.323.03	3	32.48	45
	81.323.04	4	32.48	45
	81.323.05	5	32.48	45
	81.323.06¹⁾	6 ¹⁾	32.48	45
	81.323.08¹⁾	8 ¹⁾	32.48	45
	81.323.10¹⁾	10 ¹⁾	32.48	45
	81.323.12¹⁾	12 ¹⁾	32.48	45
	81.323.14¹⁾	14 ¹⁾	32.48	45
	81.323.16¹⁾	16 ¹⁾	32.48	45
	81.323.18¹⁾	18 ¹⁾	32.48	45
	81.323.20¹⁾	20 ¹⁾	32.48	45

1) Sealed for internal coolant

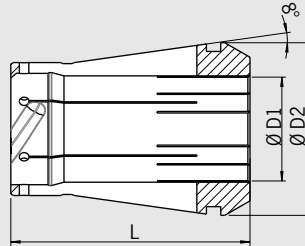
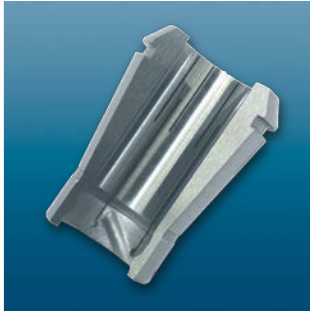

- High-precision Power Collets with stabilisation and concentration through pilot of collet
- High torque due to form closed clamping
- No pull out and no spinning of the tool
- Groove on tool shank is directed so that the tool will be pulled into the chuck (depending on direction of rotation)
- Sealed for internal coolant

INCH ER 16 (0.47-0.63)		Ø D1 [inch]	Ø D2 [inch]	L [inch]
Order No.	81.163.3/8z.7	3/8	1.001	1.46

INCH ER 25 (0.47-0.63)		Ø D1 [inch]	Ø D2 [inch]	L [inch]
Order No.	81.253.3/8z.7	3/8	1.001	1.46
	81.253.1/2z.7	1/2	1.001	1.46
	81.253.5/8z.7	5/8	1.001	1.46

INCH ER 32 (0.63-0.79)		Ø D1 [inch]	Ø D2 [inch]	L [inch]
	81.323.3/8z.7	1/2	1.28	1.77
	81.323.1/2z.7	1/2	1.28	1.77
	81.323.5/8z.7	5/8	1.28	1.77
	81.323.3/4z.7	3/4	1.28	1.77

METRIC ER 16 Clamping Ø [mm]		D1	D2	L
Order No.	81.163.06.7	6	16.45	30
	81.163.08.7	8	16.45	30
	81.163.10.7	10	16.45	30

METRIC ER 25 Clamping Ø [mm]		D1	D2	L
Order No.	81.253.06.7	6	25.45	37
	81.253.08.7	8	25.45	37
	81.253.10.7	10	25.45	37
	81.253.12.7	12	25.45	37
	81.253.14.7	14	25.45	37
	81.253.16.7	16	25.45	37

METRIC ER 32 Clamping Ø [mm]		D1	D2	L
Order No.	81.323.06.7	6	32.48	45
	81.323.08.7	8	32.48	45
	81.323.10.7	10	32.48	45
	81.323.12.7	12	32.48	45
	81.323.14.7	14	32.48	45
	81.323.16.7	16	32.48	45
	81.323.18.7	18	32.48	45
	81.323.20.7	20	32.48	45

COOL-JET BORES FOR POWER COLLETS

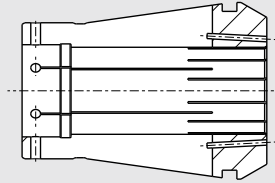
**Optional: Cool-Jet for Power Collets**

- Optimized coolant bores, aimed at center in the collet
- Coolant directly to the cutting edge
- Extended tool life up to 100%
- Higher reliability of cutting process
- Eliminates chips packing and chip welding
- Starting at ER 25 Ø 6 mm

Cool-Jet bores for Power Collets

Order No. 91.100.27

TORQUE MASTER TORQUE WRENCH AND CLAMPING WRENCH FOR HAIMER POWER COLLET CHUCK/STANDARD ER

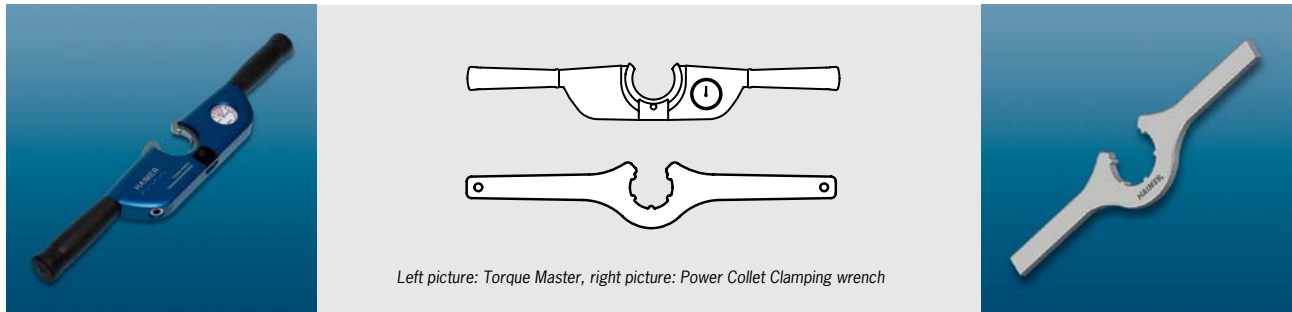

Left picture: Torque Master, right picture: Power Collet Clamping wrench

Two-armed clamping wrench and torque wrench for Collet Chucks:

- For highest runout accuracy, no one-sided clamping
- Optimal power transmission by Consistent force application
- Torque wrench for highest clamping accuracy and repeatability with dial gauge
- Maximum torque for highest clamping force
- No overloading of smaller clamping diameters
- Changeable inserts, useable also for standard ER-Collets

Torque Master	
Order No.	Size
84.600.00	ER16 – ER32

Clamping wrench	
Order No.	Size
84.650.16	ER16
84.650.25	ER25
84.650.32	ER32

POWER COLLET INSERTS FOR TORQUE MASTER

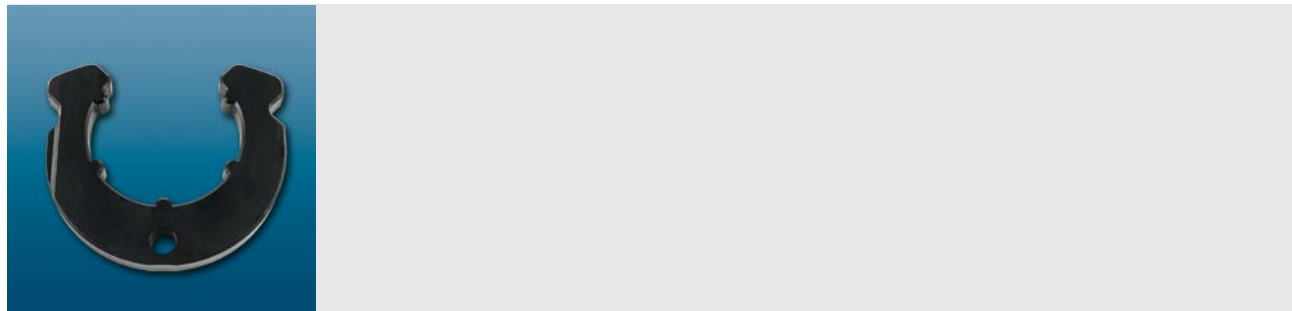

Inserts for Torque Master wrench	
for Power Collet Chucks	Size
Order No.	
84.610.16	ER16
84.610.25	ER25
84.610.32	ER32
for Standard ER Chucks	Size
84.620.11	ER11
84.620.16	ER16
84.620.20	ER20
84.620.25	ER25
84.620.32	ER32

WITH OPTIMAL CLAMPING FOR MORE PRECISION

Torque wrench for Power Collet Chucks
and tool assembly device Tool Clamp.



HG COLLETS AND HG SPINDLE WIPER

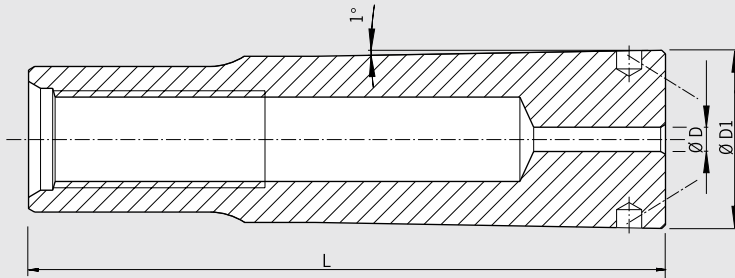

HG Collets

For clamping tools with cylindrical shank with utmost precision in HG chucks
 – Shank tolerance h6

INCH					
HG 01	Ø D [inch]	1/8"	3/16"	1/4"	5/16"
Order No.	82.510...	.1/8Z	.3/16Z	.1/4Z	.5/16Z
HG 02	Ø D [inch]	3/8"	7/16"	1/2"	9/16"
Order No.	82.520...	.3/8Z	.7/16Z	.1/2Z	.9/16Z
HG 03	Ø D [inch]	5/8"	3/4"		
Order No.	82.530...	.5/8Z	.3/4Z		

HG 01	Ø D [mm]	2	2.5	3	4	4.5	5	5.5	5.6 ^{d)}	6	6.3	7	7.1 ^{d)}	8	9
	Ø D1 [mm]	14.7	14.7	14.7	14.7	14.7	14.7	14.7	14.7	14.7	14.7	14.7	14.7	14.7	14.7
	L [mm]	52.5	52.5	52.5	52.5	52.5	52.5	52.5	52.5	52.5	52.5	52.5	52.5	52.5	52.5
Order No.	82.510...	.02	.025	.03	.04	.045	.05	.055	.056	.06	.063	.07	.071	.08	.09
HG 02	Ø D [mm]	10		11		12		12.5		14					
	Ø D1 [mm]	17.87		17.87		17.87		17.87		17.87					
	L [mm]	64.2		64.2		64.2		64.2		64.2					
Order No.	82.520...	.10		.11		.12		.125		.14					
HG 03	Ø D [mm]	16		18		20									
	Ø D1 [mm]	26.147		26.147		26.147									
	L [mm]	69.7		69.7		69.7									
Order No.	82.530...	.16		.18		.20									

Accessories

Spare parts Pull-out hook

HG

Order No. 82.570.00



Spare parts Lubrication paste

Order No. 82.585.00

Spindle wiper

For cleaning tool holder I.D. of HG chuck

HG		for HG 01	for HG 02	for HG 03
Order No.	82.590...	.01	.02	03

TOOL ASSEMBLY DEVICE TOOL CLAMP WITH VARIOUS ADAPTERS

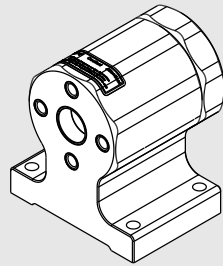

The new tool assembly device:

- Secure tool assembling
- Minimum locking force needed
- Quick-change function for different taper interfaces – without additional tooling
- Accident-free assembling of cutting tools
- Spring-loaded locking pin
- Mechanical security pin
- Better tool clamping thanks to optimum ergonomics
- Replaceable brass tool pots protect the taper surface
- Required space 140 x 100 mm



Tool Clamp



Tool holder SK

Tool Clamp without tool holder, 4 x 90° indexable	
Order No.	84.700.00

Tool holder SK (DIN/MAS-BT/CAT)	
Order No.	Type
84.701.30	CAT/BT/SK/ISO 30
84.701.40	CAT/BT/SK/ISO 40
84.701.50	CAT/BT/SK/ISO 50

Tool holder HSK-A (DIN 69893/1)	
Order No.	Type
84.702.40	HSK-A40
84.702.50	HSK-A50
84.702.63	HSK-A63
84.702.80	HSK-A80
84.702.10	HSK-A100

Tool holder HSK-C/HSK-E (DIN 69893/1)	
Order No.	Type
84.703.32	HSK-C/E32
84.703.40	HSK-C/E40
84.703.50	HSK-C/E50
84.703.63	HSK-C/E63
84.703.80	HSK-C/E80

Tool holder HSK-F	
Order No.	Type
84.704.63.M	HSK-F63
84.704.80.M	HSK-F80 MAKINO

Tool holder Capto	
Order No.	Type
84.705.40	Capto C4
84.705.50	Capto C5
84.705.60	Capto C6

Tool holder KM4X100	
Order No.	Type
84.706.4X.100	KM4X

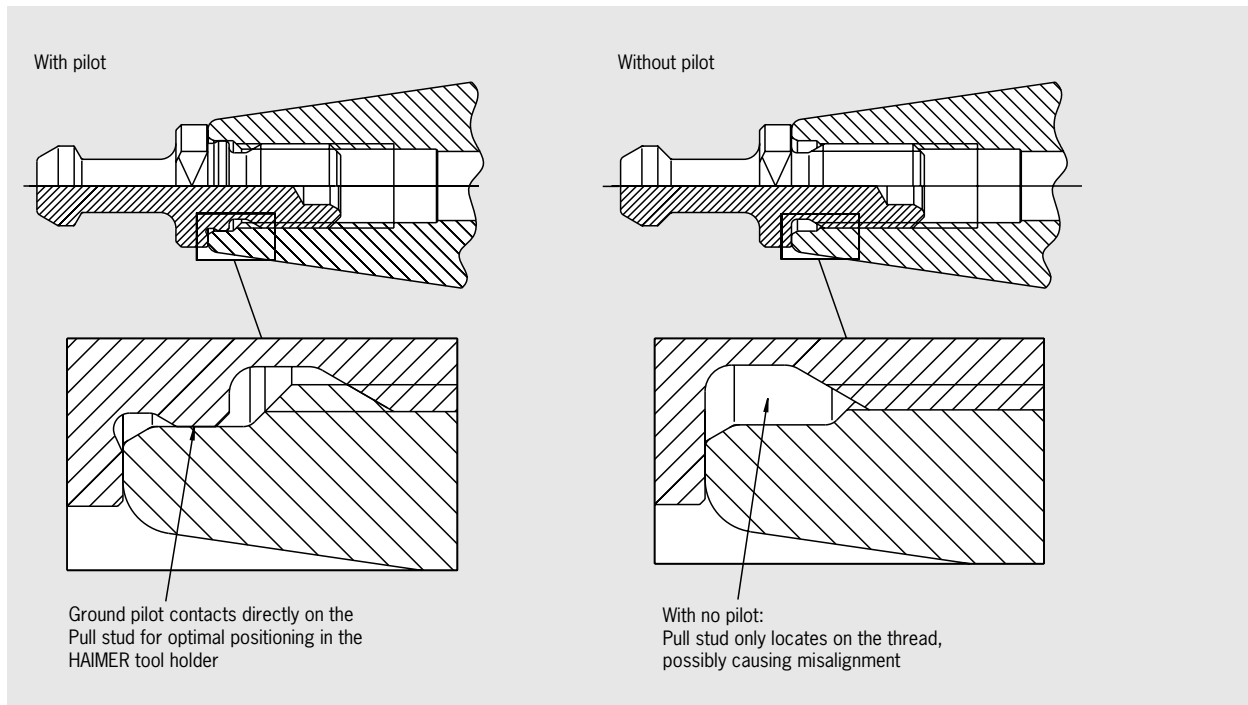

HAIMER goes far beyond the requirements of CAT 40 tooling. Our experience with tool holders and balancing have merged together to successfully create far superior CAT tapered tooling.

In addition to our contact and 100% inspection process of our tapers, HAIMER has developed a special feature to greatly increase your tool holder balance repeatability and your machine tool spindle draw mechanism repeatability.

We have added a ground pilot in the rear of all our CAT 40 tool holders. This ground pilot fits perfectly with the special HAIMER pull stud to maximize your tool holder to machine tool connection. The ground pilot is larger than the standard ANSI dimension, so you can easily use any pull stud from any manufacturer. However, for those serious about balance and machine tool spindle draw repeatability, HAIMER has the answer for you with our special pull stud/pilot connection!

PULL STUDS
CAT 40 · BT30/40 · SK40

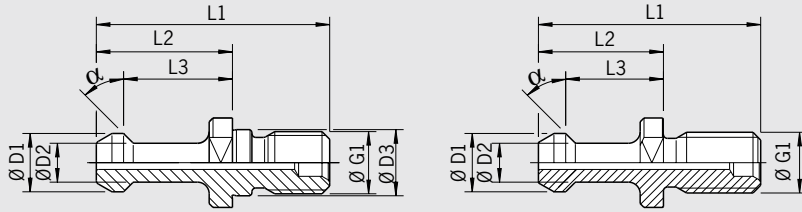

Version with ground pilot is used to help consistently locate the pull stud in the tool holder. Great for runout accuracy, balance repeatability and machine tool draw bar consistency.

All HAIMER tool holders are provided with ground center-bore to match pull stud pilot (all standard pull studs can be used as well). All metric pull studs come with a ground pilot.

CAT 40 | BT 30/40 | SK 40

Without coolant through hole	With coolant through hole	G1	D1	D2	D3	L1	L2	L3	α
Order No. MAS 30° 88.604.30	-	M12	0.43"	0.28"	0.49"	1.69"	0.91"	0.71"	30°
MAS 45° 88.601.30	-	M12	0.43"	0.28"	0.49"	1.69"	0.91"	0.71"	45°
88.601.40	-	M16	0.59"	0.39"	0.67"	2.36"	1.38"	1.10"	45°
-	88.613.40	5/8"-11UNC"	0.59"	0.39"	-	2.25"	1.27"	0.99"	45°
88.621.40	88.623.40	5/8"-11UNC" + pilot	0.59"	0.39"	0.67"	2.25"	1.27"	0.99"	45°
JIS 6339 Makino									
-	88.700.40	M16	0.75"	0.55"	0.67"	2.13"	1.14"	0.91"	15°
-	88.710.40	5/8"-11UNC"	0.75"	0.55"	-	2.01"	1.03"	0.79"	15°
-	88.720.40	5/8"-11UNC" + pilot	0.75"	0.55"	0.67"	2.01"	1.03"	0.79"	15°
-	88.800.40	M16	0.75"	0.55"	0.67"	2.13"	1.03"	0.79"	15°
ANSI B5.5 Mazak									
-	88.510.40	5/8"-11UNC"	0.74"	0.49"	-	1.62"	0.64"	0.44"	45°
-	88.520.40	5/8"-11UNC" + pilot	0.74"	0.49"	0.67"	1.62"	0.64"	0.44"	45°
-	88.500.40.1	M16	0.74"	0.49"	0.67"	1.62"	0.64"	0.44"	45°
MAS 90° Mori Seiki									
88.111.40	-	5/8"-11UNC"	0.59"	0.39"	-	2.25"	1.27"	0.99"	90°
88.121.40	-	5/8"-11UNC" + pilot	0.59"	0.39"	0.67"	2.25"	1.27"	0.99"	90°
DIN 69872									
-	88.200.40	M16	0.75"	0.55"	0.67"	2.13"	1.02"	0.78"	15°

PULL STUDS
CAT 50 · BT50

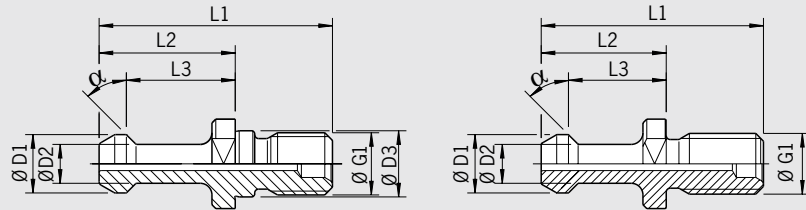

Version with ground pilot is used to help consistently locate the pull stud in the tool holder. Great for runout accuracy, balance repeatability and machine tool draw bar consistency.

All HAIMER tool holders are provided with ground center-bore to match pull stud pilot (all standard pull studs can be used as well). All metric pull studs come with a ground pilot.

CAT 50 | BT 50

Without coolant through hole	With coolant through hole	G1	D1	D2	D3	L1	L2	L3	α
Order No.									
MAS 45°									
88.601.50	-	M24	0.91"	0.67"	0.98"	3.35"	1.77"	1.38"	45°
88.611.50	88.613.50	1"-8UNC"	0.91"	0.67"	-	3.35"	1.78"	1.39"	45°
-	88.623.50	1"-8UNC" + pilot	0.91"	0.67"	1.06"	3.35"	1.78"	1.39"	45°
MAS 30°									
88.604.50	-	M24	0.91"	0.67"	0.98"	3.35"	1.77"	1.38"	30°
88.614.50	88.615.50	1"-8UNC"	0.91"	0.67"	-	3.35"	1.78"	1.39"	30°
88.624.50	88.625.50	1"-8UNC" + pilot	0.91"	0.67"	1.06"	3.35"	1.78"	1.39"	30°
JIS 6339 Makino									
-	88.700.50	M24	1.1"	0.83"	0.98"	2.91"	1.34"	0.98"	15°
-	88.720.50	1"-8UNC" + pilot	1.1"	0.83"	1.06"	2.92"	1.35"	0.99"	15°
Ansi B5.50 Mazak									
-	88.500.50	M24	1.14"	0.82"	0.98"	2.57"	1"	0.70"	45°
-	88.510.50	1"-8UNC"	1.14"	0.82"	-	2.57"	1"	0.70"	45°
-	88.520.50	1"-8UNC" + pilot	1.14"	0.82"	1.06"	2.57"	1"	0.70"	45°
MAS 90° Mori Seiki									
88.101.50	-	M24	0.91"	0.67"	0.98"	3.35"	1.77"	1.38"	90°
88.111.50	-	1"-8UNC"	0.91"	0.67"	-	3.35"	1.78"	1.39"	90°
88.121.50	-	1"-8UNC" + pilot	0.91"	0.67"	1.06"	3.35"	1.78"	1.39"	90°
-	88.800.50	M24	1.10"	0.83"	0.98"	2.91"	1.34"	0.99"	15°

REDUCTION SLEEVES

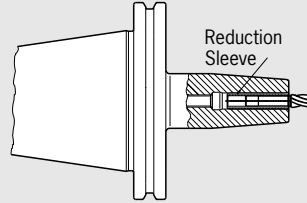
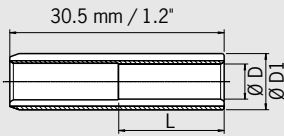

Use:

For clamping small shanks in chucks with $\varnothing 5/16"$ or 8 mm ID's.

For use in all chucks as reducers

- HG-chucks
- Collet chucks
- Hydraulic chucks
- Other high precision mechanical chucks.

INCH		Ø D	Ø D1	L
Order No.	79.110.3/32Z	3/32"	5/16"	0.27"
Order No.	79.110.1/8Z	1/8"	5/16"	0.35"
Order No.	79.110.5/32Z	5/32"	5/16"	0.47"
Order No.	79.110.3/16Z	3/16"	5/16"	0.56"
Order No.	79.110.7/32Z	7/32"	5/16"	0.65"

METRIC [mm]		Ø D	Ø D1	L
Order No.	79.110.2.5	2.5	8	7.5
Order No.	79.110.3	3	8	9
Order No.	79.110.3.5	3.5	8	10.5
Order No.	79.110.4	4	8	12
Order No.	79.110.4.5	4.5	8	13.5
Order No.	79.110.5	5	8	15
Order No.	79.110.5.5	5.5	8	16.5

BALANCING INDEX RINGS
SET OF BALANCING SCREWS

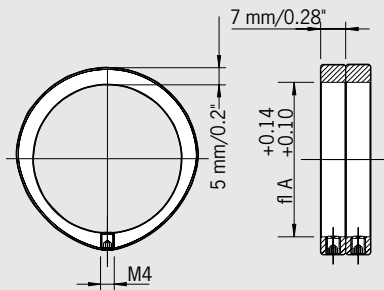

Make your standard tool holder a balanceable tool holder quick and easily

- Included in delivery: 2 balancing index rings with screws
- Tightening torque: 1 ft lb (1.4 Nm)

Set of balancing screws comprising
11 x 10 screws and screw driver
Order No. 80.203.00

Order No.	Ø A [mm]	Ø A [inch]	ca. unbalance
79.350.15	15	0.59"	9 g·mm
79.350.17	17	0.67"	12 g·mm
79.350.19	19	0.75"	16 g·mm
79.350.20	20	0.79"	17 g·mm
79.350.22	22	0.87"	20 g·mm
79.350.24	24	0.94"	27 g·mm
79.350.25	25	0.98"	32 g·mm
79.350.26	26	1.02"	33 g·mm
79.350.27	27	1.06"	33 g·mm
79.350.28	28	1.10"	40 g·mm
79.350.30	30	1.18"	45 g·mm
79.350.32	32	1.26"	36 g·mm
79.350.34	34	1.34"	40 g·mm
79.350.35	35	1.38"	48 g·mm
79.350.36	36	1.42"	47 g·mm
79.350.38	38	1.50"	53 g·mm
79.350.40	40	1.57"	57 g·mm
79.350.42	42	1.65"	65 g·mm
79.350.43	43	1.69"	65 g·mm
79.350.1.71Z	43.45	1.71"	68 g·mm
79.350.44	44	1.73"	68 g·mm
79.350.46	46	1.81"	75 g·mm
79.350.48	48	1.89"	81 g·mm
79.350.50	50	1.97"	87 g·mm
79.350.52	52	2.05"	94 g·mm
79.350.53	53	2.09"	86 g·mm
79.350.54	54	2.13"	91 g·mm

Order No.	Ø A [mm]	Ø A [inch]	ca. unbalance
79.350.55	55	2.17"	94 g·mm
79.350.56	56	2.20"	100 g·mm
79.350.58	58	2.28"	106 g·mm
79.350.60	60	2.36"	110 g·mm
79.350.62	62	2.44"	120 g·mm
79.350.63	63	2.48"	123 g·mm
79.350.64	64	2.52"	126 g·mm
79.350.65	65	2.56"	129 g·mm
79.350.66	66	2.60"	120 g·mm
79.350.68	68	2.68"	135 g·mm
79.350.70	70	2.76"	145 g·mm
79.350.72	72	2.83"	152 g·mm
79.350.74	74	2.91"	160 g·mm
79.350.76	76	2.99"	168 g·mm
79.350.78	78	3.07"	178 g·mm
79.350.80	80	3.15"	186 g·mm
79.350.82	82	3.23"	199 g·mm
79.350.84	84	3.31"	215 g·mm
79.350.86	86	3.39"	224 g·mm
79.350.87	87	3.43"	225 g·mm
79.350.88	88	3.46"	226 g·mm
79.350.89	89	3.50"	231 g·mm
79.350.90	90	3.54"	237 g·mm
79.350.92	92	3.62"	247 g·mm
79.350.94	94	3.70"	253 g·mm
79.350.96	96	3.78"	267 g·mm
79.350.98	98	3.86"	277 g·mm
79.350.100	100	3.94"	285 g·mm

2 m hex wrench not included

HAIMER rings will work on many brands of tool holders

COOLANT TUBES

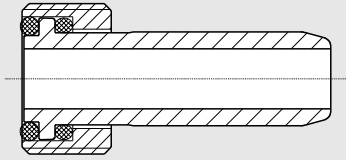

- Dual o-ring design makes tube slightly movable
- Coated steel with smooth surface for trouble free insertion into the machine spindle
- Fits all brands of HSK holders
- Must be used with all coolant through HSK spindles

Coolant tube with 2 o-rings for	HSK A-32	HSK-A 40	HSK-A 50	HSK-A 63	HSK-A 80	HSK-A 100	HSK-A 125
	HSK-E 32	HSK-E 40	HSK-E 50				
Order No. 85.700...	.32	.40	.50	.63	.80	.100	.125

Accessories

Wrench		HSK 32	HSK 40	HSK 50	HSK 63	HSK 80	HSK 100	HSK 125
Order No.	84.500...	.32	.40	.50	.63	.80	.100	.125

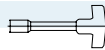

TENSION SPRINGS FOR SHRINK FIT CHUCKS



- Spring is set into clamping bore
- Spring presses tool against stop disc
- Fits all common shrink fit chucks
- Backup screw can remain in chuck



Tension spring for length presetting

											Order No.
Tension spring		∅ 6	∅ 8	∅ 10	∅ 12	∅ 14	∅ 16	∅ 18	∅ 20	∅ 25	∅ 32
Order No.	85.830...	.06	.08	.10	.12	.14	.16	.18	.20	.25	.32
Tension spring set (10 pcs. of each size) incl. grab											85.830.00

SHRINK FIT BRUSHES

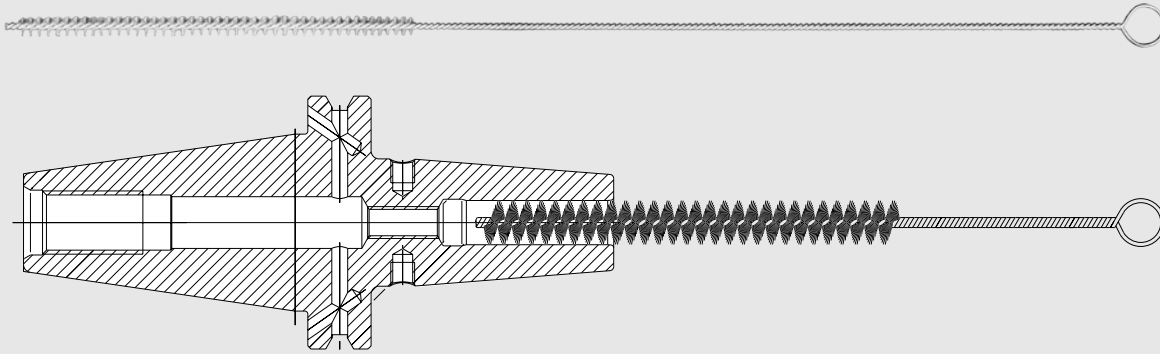

In order to achieve the best possible shrink fit connection, a grease free socket and shank is necessary. The cleaning can be done by a cold solvent (e.g. brake cleaner). An appropriate cleaning brush is necessary to clean the socket of the Shrink Fit Chuck.

Shrink Fit Brush Order No.	Ø [inch]
86.200.01	1/8" (3.175)
86.200.02	3/16" (4.762)
86.200.03	1/4" (6.35)
86.200.03	5/16" (7.93)
86.200.04	3/8" (9.525)
86.200.04	7/16" (11.112)
86.200.05	1/2" (12.7)
86.200.06	5/8" (15.875)
86.200.07	3/4" (19.05)
86.200.08	1" (25.4)

Shrink Fit Brush Order No.	Ø [mm]
86.200.01	3
86.200.02	3.5
86.200.02	4
86.200.02	4.5
86.200.02	5
86.200.03	6
86.200.03	8
86.200.04	10
86.200.04	12
86.200.06	14
86.200.06	16
86.200.07	18
86.200.07	20
86.200.08	25

BACK UP SCREWS FOR SHRINK FIT CHUCKS & POWER COLLET CHUCKS

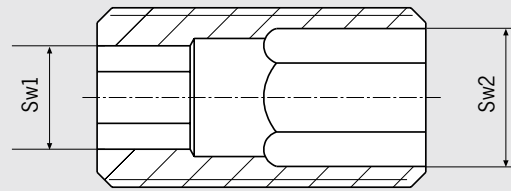
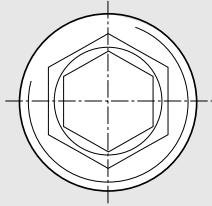

- Hexagon socket on each end – can always be reached
- Flats on sides for optimized coolant drainage
- Fine thread for maximum accuracy

For Shrink Fit Chucks

[mm]		CAT 40/50 SK 40/50 BT 40/50	HSK-A 32/E 32 A 40/E 40	HSK-A 50/ E 50	HSK-A 63	HSK-F 63	HSK-A 80	HSK-A 100
Clamping Ø	Length Order No. 85.810...							
6		.12.1	.12.1	.12.1	.12.1	.12.1	.12.1	.12.1
8		.15.1	.15.1	.15.1	.15.1	.15.1	.15.1	.15.1
10	short	.18.2	.18.2	.18.2	.18.2	.18.2	.18.2	.18.2
	other	.18.2	.36.2	.36.2	.36.2	.36.2	.36.2	.36.2
12	short	.24.2	.24.2	.39.2	.39.2	.39.2	.21.2	.21.2
	other	.24.2	.24.2	.24.2	.24.2	.24.2	.24.2	.24.2
14	short	.24.2	.24.2	.39.2	.39.2	-	.21.2	.21.2
	ZG130/oversize	.24.2	.24.2	.24.2	.24.2	-	.24.2	.24.2
16	short	.46.2	.27.2	.25.2	.25.2	.25.2	.27.2	.40.1
	ZG130/oversize	.46.2	.27.2	.38.2	.46.2	.46.2	.46.2	.46.2
18	short	.46.2	-	.25.2	.25.2	-	.27.2	.40.1
	ZG130/oversize	.46.2	-	.38.2	.46.2	-	.46.2	.46.2
20	short	.52.2	-	.51.2	.51.2	.51.2	.51.2	.51.2
	ZG130/oversize	.52.2	-	.52.2	.52.2	.52.2	.52.2	.52.2
25	short	.52.2	-	-	.52.2	.52.2	.52.2	.52.2
	ZG130/oversize	.52.2	-	-	.52.2	.52.2	.52.2	.52.2
32	short	.52.2	-	-	.52.2	-	.52.2	.52.2
	ZG130/oversize	.52.2	-	-	.52.2	-	.52.2	.52.2

For Shrink Fit Chucks & Power Collet Chucks

Order No.	SW1	SW2	Thread	Also usable for Power Collet Chucks
85.810.12.1	SW2.5	SW2.5	M5x0.8x16	
85.810.15.1	SW3	SW3	M6x1x16	
85.810.18.2	SW3	SW4	M8x1x16	ER16
85.810.24.2	SW4	SW5	M10x1x20	
85.810.37.2	SW6	SW8	M12x1x22	ER25
85.810.46.2	SW6	SW8	M12x1x20	ER25
85.810.25.2	SW5	SW6	M12x1x18	ER25
85.810.27.2	SW4	SW6	M12x1x18	ER25
85.810.36.2	SW3	SW4	M8x1x20	ER16

Order No.	SW1	SW2	Thread	Also usable for Power Collet Chucks
85.810.21.2	SW4	SW5	M10x1x16	
85.810.38.2	SW5	SW6	M12x1x22	ER25
85.810.39.2	SW4	SW5	M10x1x18	
85.810.40.1	SW6	SW6	M12x1x16	ER25
85.810.43.2	SW5	SW8	M12x1x18	ER25
85.810.44.2	SW5	SW8	M12x1x22	ER25
85.810.45.2	SW6	SW8	M12x1x18	ER25
85.810.51.2	SW5	SW8	M16x1x18	ER32
85.810.52.2	SW6	SW8	M16x1x22	ER32

BACK UP SCREWS FOR SHRINK FIT CHUCKS & POWER COLLET CHUCKS

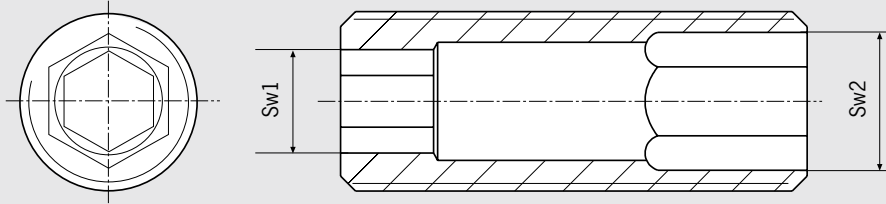

- Hexagon socket on each end – can always be reached
- Flats on sides for optimized coolant drainage
- Fine thread for maximum accuracy

For Shrink Fit Chucks

[mm]		CAT 40/50 SK 40/50 BT 40/50	HSK-A 32/E 32 A 40/E 40	HSK-A 50 E 50	HSK-A 63	HSK-F 63	HSK-A 80	HSK-A 100
Clamping Ø	Length Order No. 85.810...							
6		.12.4	.12.4	.12.4	.12.4	.12.4	.12.4	.12.4
8		.15.4	.15.4	.15.4	.15.4	.15.4	.15.4	.15.4
10		.18.4	.18.4	.18.4	.18.4	.18.4	.18.4	.18.4
12		.21.4	.21.4 ¹⁾	.21.4	.21.4	.21.4	.21.4	.21.4
14		.21.4	.21.4	.21.4	.21.4	.21.4	.21.4	.21.4
16	short	.37.4	.27.4	.25.4	.25.4	.25.4	.27.4	.40.4
	ZG130/oversize	.37.4	.27.4	.25.4	.37.4	.37.4	.37.4	.37.4
18	short	.37.4	-	.25.4	.25.4	.25.4	.27.4	.40.4
	ZG130/oversize	.37.4	-	.25.4	.37.4	.37.4	.37.4	.37.4
20	short	.52.4	-	.52.4	.52.4	.52.4	.52.4	.52.4
	ZG130/oversize	.52.4	-	.52.4	.52.4	.52.4	.52.4	.52.4
25		.52.4	-	-	.52.4	.52.4	.52.4	.52.4
32		.52.4	-	-	.52.4	.52.4	.52.4	.52.4

For Shrink Fit Chucks & Power Collet Chucks

Order No.	SW1	SW2	Thread	Also usable for Power Collet Chucks
85.810.12.4	SW2.5	SW2.5	M5x0.8x24	
85.810.15.4	SW3	SW3	M6x1x24	
85.810.18.4	SW3	SW4	M8x1x24	ER16
85.810.21.4	SW4	SW5	M10x1x28	
85.810.37.4	SW6	SW8	M12x1x34	ER25
85.810.43.4	SW5	SW8	M12x1x34	ER25
85.810.25.4	SW5	SW6	M12x1x34	ER25
85.810.27.4	SW4	SW6	M12x1x34	ER25
85.810.52.4	SW6	SW8	M16x1x34	ER32

1) HSK-A 32 Ø 12 = Order No. 85.810.18.4

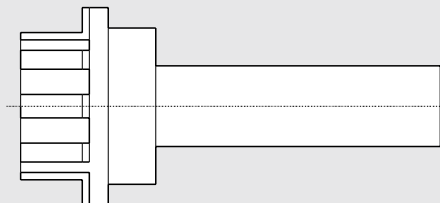

For cleaning spindles

Spindle wiper HSK	for HSK 32	for HSK 40	for HSK 50	for HSK 63	for HSK 80	for HSK 100
Order No. 85.820...	.32	.40	.50	.63	.80	.100

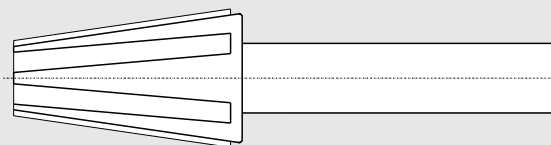

Spindle wiper SK, BT, CAT	for SK 40	for BT 40	for CAT 40	for SK 50	for BT 50	for CAT 50
Order No. 86.100...	.40	.40	.40	.50	.50	.50

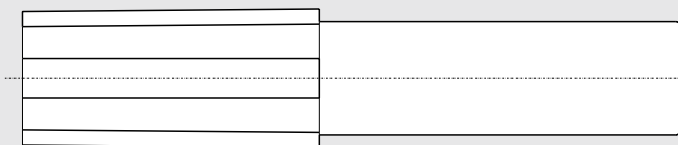

HG Collet Chuck wiper	for HG 01	for HG 02	for HG 03
Order No. 82.590...	.01	.02	.03

TECHNICAL DATA

TAPER AND HOLDER SPECIFICATIONS

Features and Benefits:

- Taper: Micron-exact manufacturing (AT3) extends the life of your spindle due to superior taper contact
- All Tapers inspected during production to ensure maximum taper contact = maximum accuracy
- All tool holders easily balanceable
- Tapers Form ADB. Central coolant supply through the pull stud (Form AD, pull stud drilled through) and coolant channels through the flange (Form B, pull stud sealed) which can be sealed again
- Minimal runout
- All holders marked with an identification number
- All holders come standard with pocket for data chip (Except BT Tapers)
- Pre-balanced to G 2.5 at 25,000 RPMs
- Fine balancing available for an extra charge
- Many tapers available (for SK 40 and SK 50, HSK-A 32, HSK-A 50 and HSK-A 80 please see European catalogs)
- 3 piece minimum order quantity on specials or discontinued items

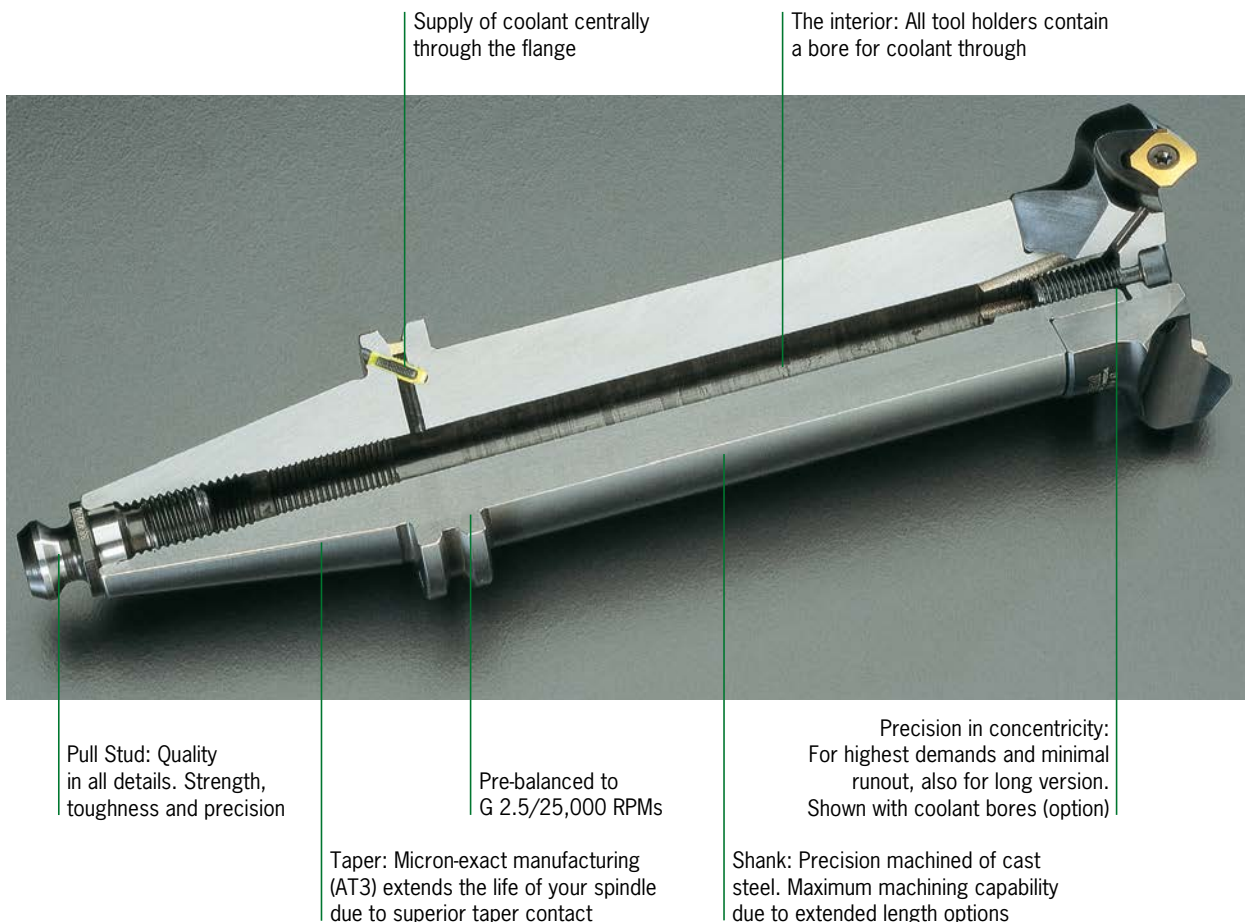

OVERVIEW OF TAPERS
CAT 40/50

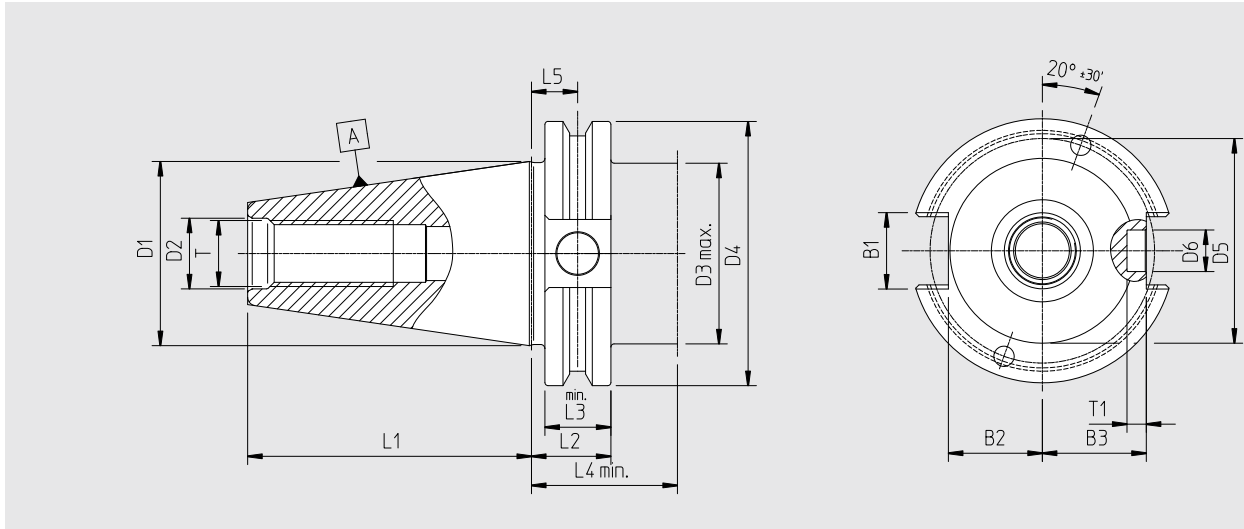

INCH	Taper Size	D1	D2	D3 max.	D4	D5	D6	L1	L2	L3	L4 min.	L5	T	T1	B1	B2	B3
	CAT 40	1.75	0.669	1.71	2.5	2.126	0.39	2.687	0.75	0.625	1.38	0.44	5/8"-11	0.18	0.646	0.89	0.984
	CAT 50	2.75	1.063	2.71	3.875	3.307	0.39	4.0	0.75	0.625	1.38	0.44	1"-8	0.18	1.02	1.39	1.484

OVERVIEW OF TAPERS
BT 30/40/50

Angle of cone: $8^{\circ} 17'50''^{+5^{\circ}}$

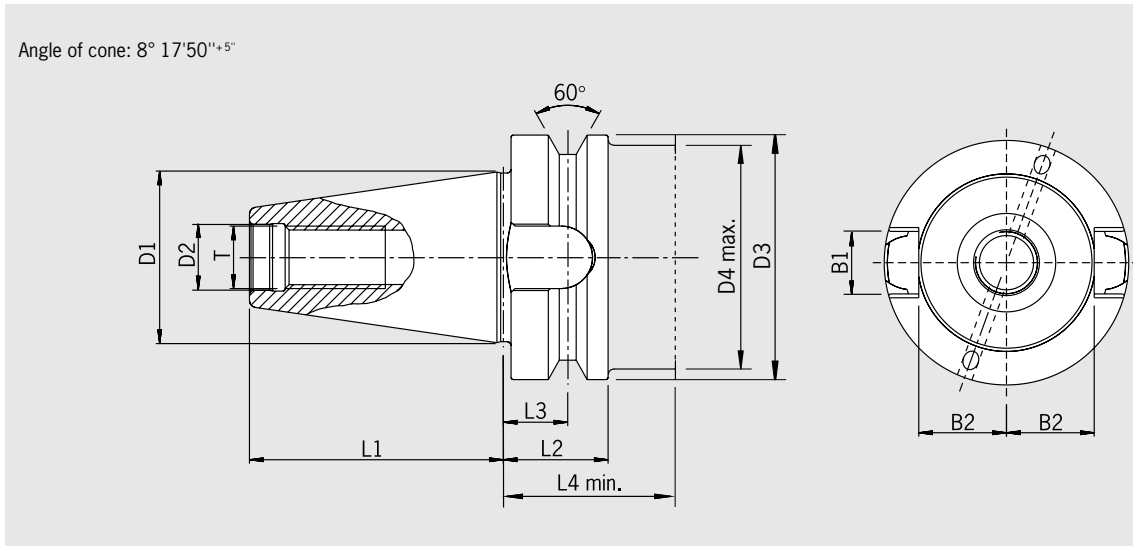

METRIC	Taper Size [mm]	D1	D2	D3	D4	L1	L2	L3	L4	T	B1	B2
	BT30	31.75	12.5	46	42	48.4	22	13.6	34.5	M12	16.1	16.3
	BT40	44.45	17	63	59	65.4	27	16.6	45	M16	16.1	22.6
	BT50	69.85	25	100	95.5	101.8	38	23.2	51	M24	25.7	35.4

OVERVIEW OF TAPERS HSK

HSK-A

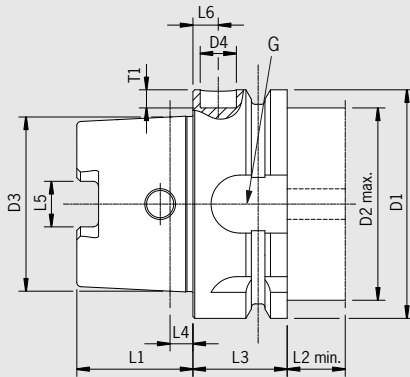

HSK-E

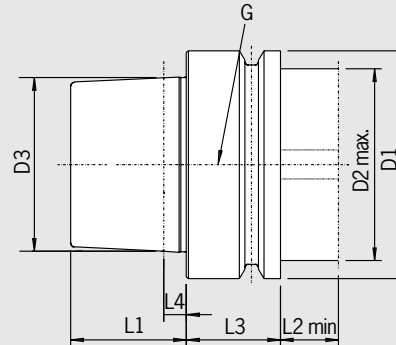

METRIC	Taper Size [mm]	D1	D2 max.	D3	D4	L1	L2 min.	L3	L4	L5	L6	G	T1
HSK-E 25		25	20	19.006	-/-	13	10	10	2.5	—	—	M8x1	-/-
HSK-A/E 32		32	26	24.007	10/-	16	15	20	3.2	7.05	7	M10x1	5.4/-
HSK-A/E 40		40	34	30.007	10/-	20	15	20	4	8.05	7	M12x1	5.3/-
HSK-A/E 50		50	42	38.009	10/-	25	16	26	5	10.54	7	M16x1	5.2/-
HSK-A/E 63		63	53	48.010	10/-	32	16	26	6.3	12.54	7	M18x1	5/-
HSK-A/E 80		80	67	60.012	10/-	40	16	26	8	16.04	7	M20x1.5	5/-
HSK-A/E 100		100	85	75.013	10/-	50	16	29	10	20.02	7	M24x1.5	4.9/-
HSK-A/E 125		125	111	95.016	10/-	63	16	29	12.5	25.02	7	M30x1.5	4.8/-

HSK-F

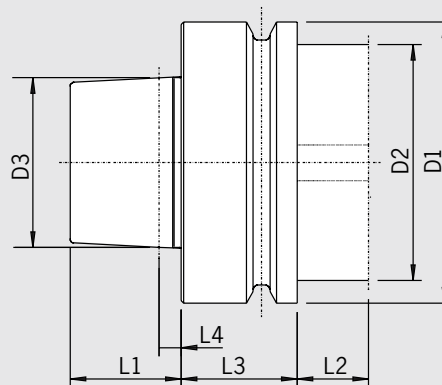

METRIC	Taper Size [mm]	D1	D2 max.	D3	L1	L2 min.	L3	L4
HSK-F 63		63	53	38.009	25	16	26	5
HSK-F 80 Makino		80	78	48.01	32	16	26	6.3

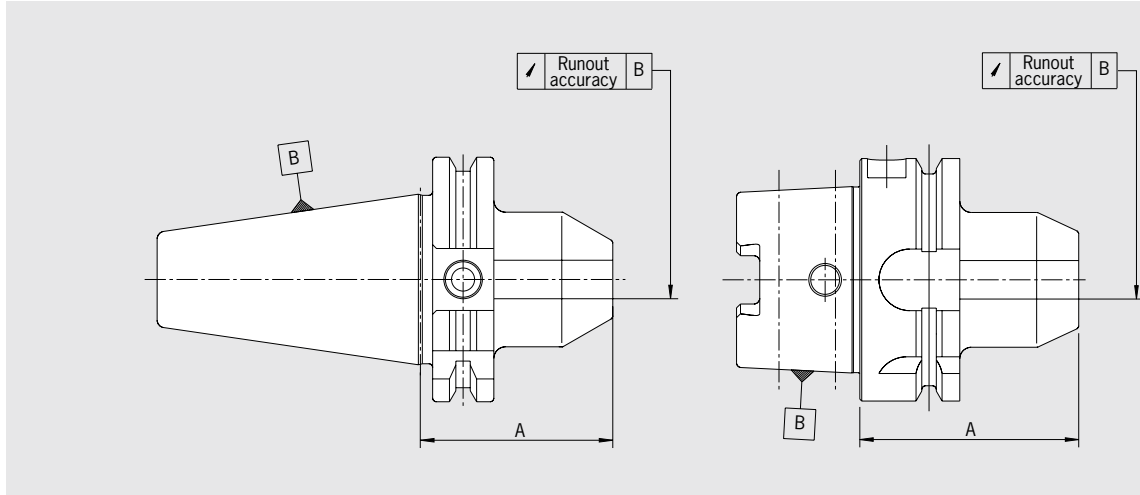

INCH	Gage length A [inch]	A < 6.3	A >= 6.3
Shrink fit Chuck	runout	0.00008	0.00016
Collet Chuck Type ER	runout	0.00012	0.00016
HG Chuck	runout	see Catalogue	
Face Mill Arbor	runout	0.00024	0.00024
Side Lock Chuck	runout	0.00012	0.00016

Balancing

Please see catalog page for pre-balanced quality grade per taper and style of holder. Please note that balance grade listed per holder is for the holder only. For best results, balance the whole assembly (tool holder, pull stud, collet, nut, cutting tool). Each element of the assembly can affect the overall balance of the tool. Please see the HAIMER “Tool Dynamic” Modular Balancing Machine catalog for more information or call HAIMER for a more detailed explanation.

OVERVIEW OF TAPERS HAIMER CAPTO™ C6 ISO 26623

Compared to the steep taper the HAIMER CAPTO™ has the following advantages:

- High repetition accuracy when clamping tools into spindle
- Fixed axial positioning by flat contact surface
- Suitable for high speed cutting
- No pull stud necessary
- Interface with a unique tapered polygon and flange location face
- Exact positioning in the spindle

- Highest runout accuracy, torque and rigidity
- Innovative modular tool system with highest precision
- Suitable for both turning and milling centers
- Incl. chip bore

Material:

- Special case-hardening steel for highly stressed parts
- Surface hardness: 60-2 HRC
- **Tensile strength in core min. 950 N/mm²**

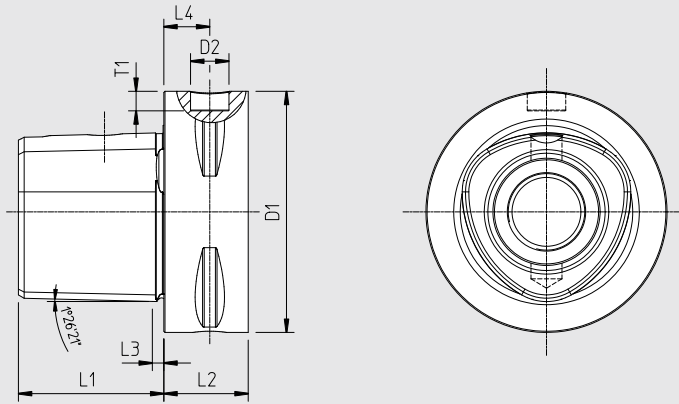

Length [mm]	D1	L1	L2	L3	L4	D2	T1
HAIMER CAPTO™ C6	63	38	22	3	12	10	5

RUNOUT ACCURACY ISO 26623

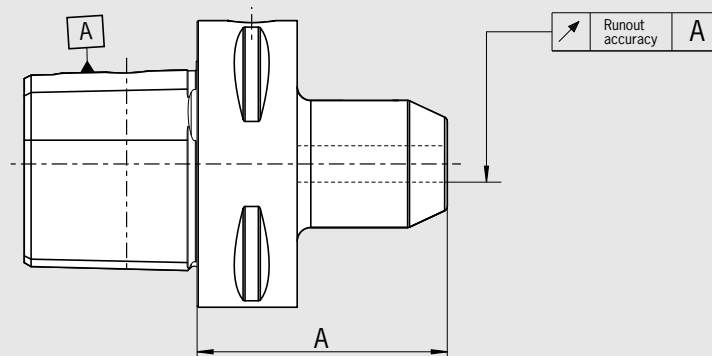

Gage length	A < 160	A ≥ 160
max. runout tolerance in mm		
Shrink fit chuck	0.003	0.004
Collet chuck ER	0.003	0.004
Power Collet Chuck	0.003	0.004
Weldon tool holder	0.003	0.004
Face mill arbor	0.006	0.006

COMPARISON SHRINK FIT CHUCKS – HAIMER VS. COMPETITOR

Competitor

HAIMER

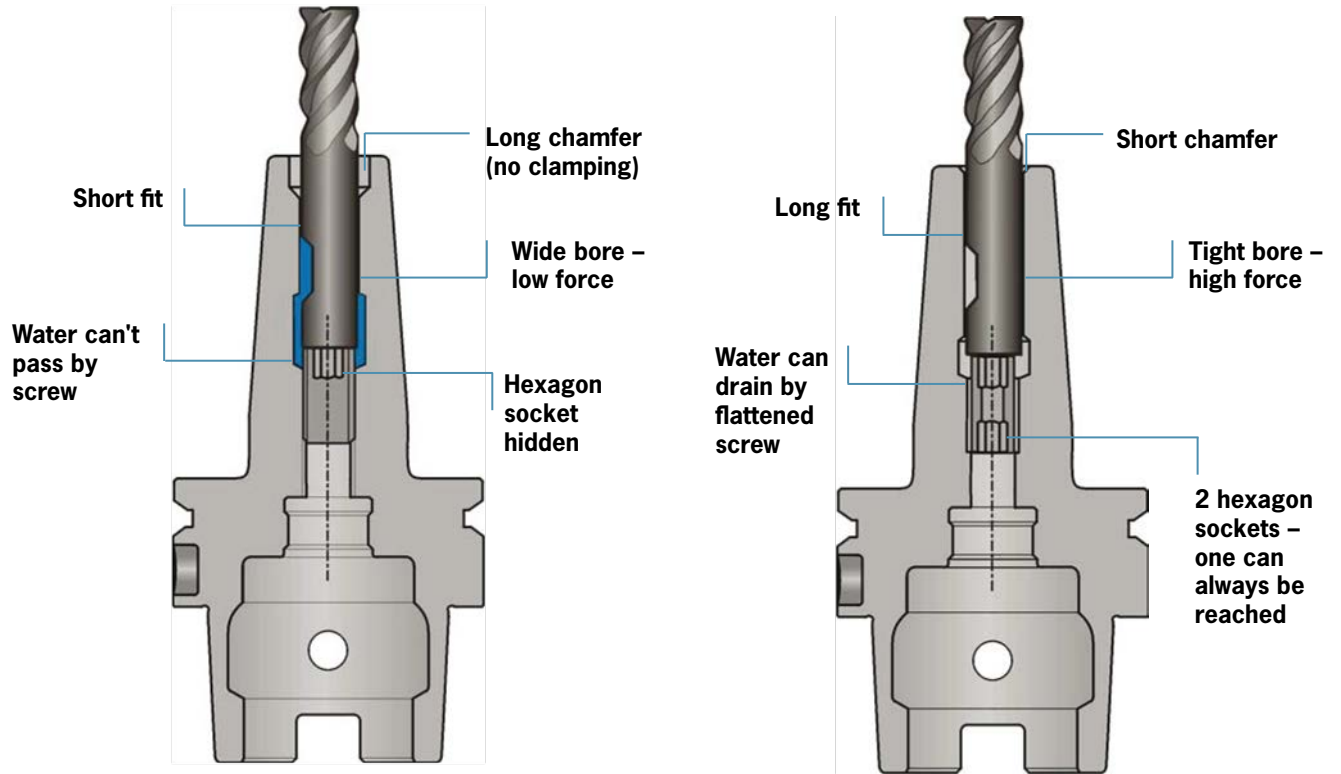

Comparison Shrink Fit Clamping Torque

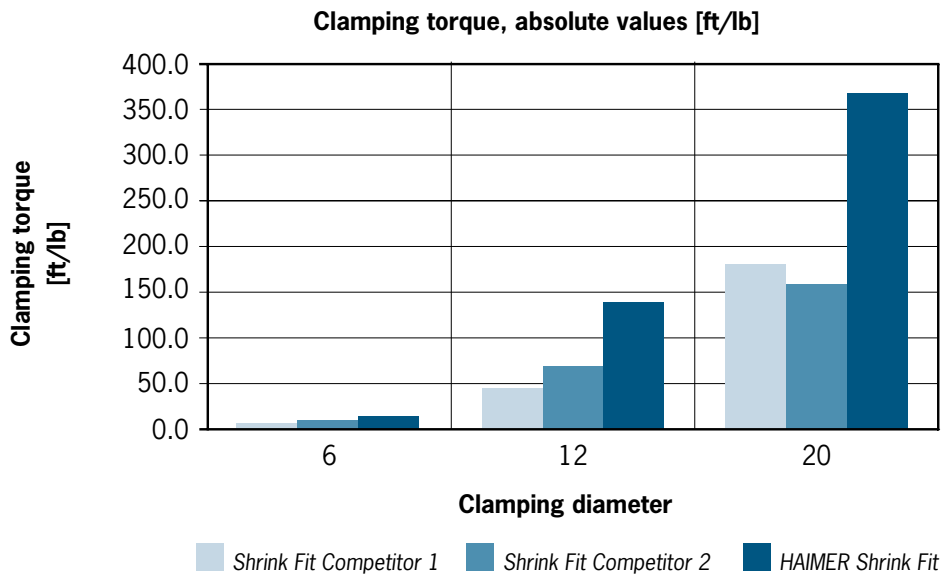

SHRINK FIT CHUCKS ADVANTAGES

Total quality control

- All shrink chucks built by HAIMER in house
- HAIMER is a true innovator – making shrink fit an even better solution for everyone
- Shrinking of carbide and HSS tools from diameter 3 – 50 mm (1/8" to 2") in tolerance h6
- Even small clamping diameter 3 – 5 mm (1/8", 3/16") suitable for HSS tools with shank tolerance h6

Highest clamping force due to extreme pressure on shank

- Highest pull out force
- Highest torque (see diagram)
- Secure clamping even when tool shank is at lower range of tolerance
- Optimum process security

Optimum support of tool

- Short chamfer for inserting tool – clamping up to the top (see sketch)
- Long fit – support of tool on whole length (see sketch)
- Extreme rigidity
- Long tool life
- No movement of tool in tool holder

Patented security set screw (see sketch)

- No dangerous development of steam when heating due to total drainage of water
- Precise length adjustment due to fine pitch thread (small clearance)
- Hexagon socket on both ends
- Simple removing of tool after breakage (on hexagon socket always can be reached)

Long life of tool holder

- High-temperature resistant special steel (tested more than 2,000 times)
- No wearing of clamping bore due to high clamping forces and short chamfer
- No distortion due to special hardening method

More

- For heavy-duty machining reinforced chucks type Power Shrink or Heavy Duty
- Flexible tool length with shrink fit extensions – no more special tool holders
- Optimum coolant supply by Cool-Jet or Cool Flash system (no interruption of the bore)
- Balanced to G 2.5 at 25,000 RPMs or under 1 gmm of unbalance (dependant upon taper)
- Fine balancing with set screws possible
- Several lengths on stock
- Slender shape – "Mini-Shrink" available
- Outer shape can be machined by user
- Dimensions according to DIN 69882-8 - Inch and metric bore diameters standard
- T. I. R. 0.003 mm at 3 times diameter (0.00012")
- Steep taper in tolerance AT 3, form ADB (coolant through center and through collar)
- All DIN and HSK include pocket for data chip
- CAT 40 and CAT 50 holders have ground pilot for pull-stud connection
- CAT 40 and CAT 50 standard with DIN-B coolant delivery option



COOL-JET – CUT THE CHIP ONLY ONCE!

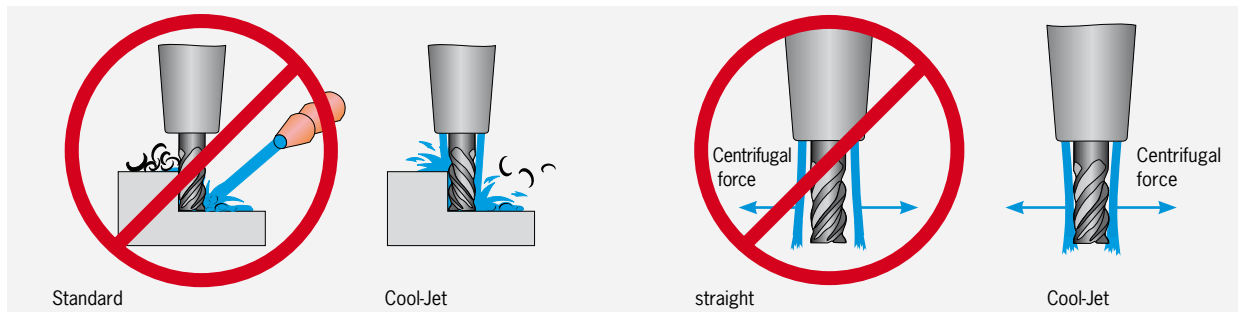

- Coolant directly to the cutting edge
- Extended tool life up to 100%
- Higher reliability of cutting process
- Eliminates chips packing and chip welding

Function at high spindle speed

Previous coolant bores: straight
 Optimized coolant bores: aimed at center

Cool-Jet available in following versions

- Cool-Jet with 2 Coolant bores for Shrink fit chucks (Ø 6–14 mm), Weldon (Ø 6–20mm) and HG Collets
- Cool-Jet with 3 Coolant bores (Shrink fit chuck Ø 16 mm – 32 mm)
- Cool-Jet with 4 Coolant bores for Weldon (Ø 25–40mm) and Whistle Notch (Ø 25–40 mm)

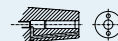

Order No.

- 91.100.24
- 91.100.25
- 91.100.26

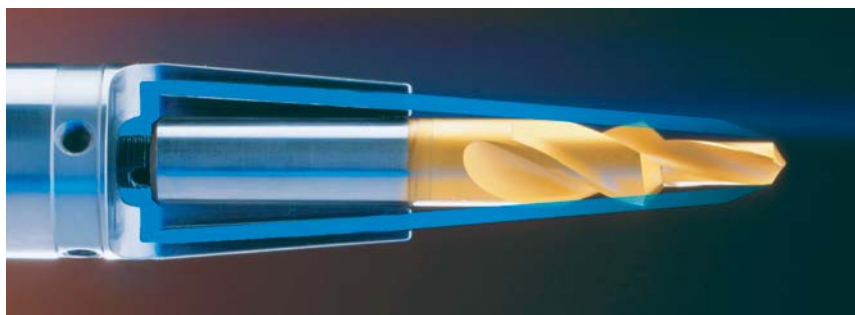

Shrink fit chuck

Examples

- For use in:
- Shrink fit chuck
 - HG chuck
 - Face Mill Arbor
 - Weldon

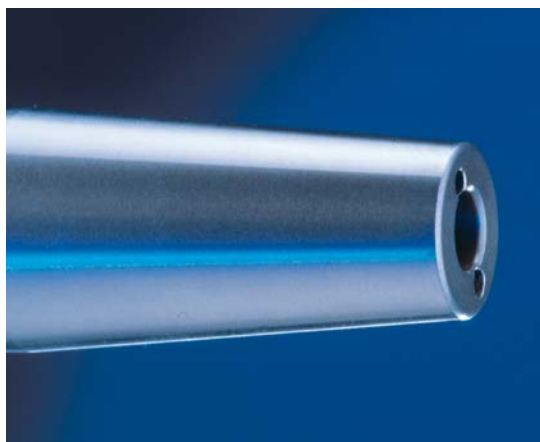

Coolant bores aimed at center
 Cool-Jet by HAIMER



Weldon

HAIMER[®]
Quality Wins.

A New Star in Town

SAFE-LOCK[®]

The new standard for
roughing applications



COOLING SYSTEM COOL FLASH – COOLANT TAKEN TO THE TOP

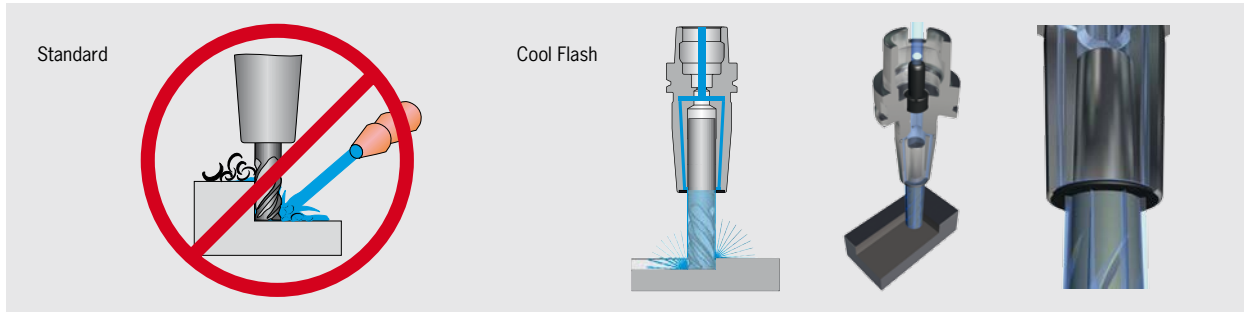

True to the slogan “make good things even better” HAIMER has developed the Cool Flash system out of the existing Cool-Jet system. The Cool Flash design directs coolant into T-slots at the nose of the holder and works with the centrifugal force of the rotating tool to lead the coolant along the shank of the cutter and directly to the flutes at any speed.

- Coolant directly to the cutting edge
- Extended tool life up to 100 %
- Eliminates chip packing and chip welding
- Also for high rpm
- Optimized runout accuracy! No additional unbalance! No disturbing clearance!
- Low acquisition costs & can be added later
- For tools from diam. ¼"-1" (6 mm up to diam. 25 mm)

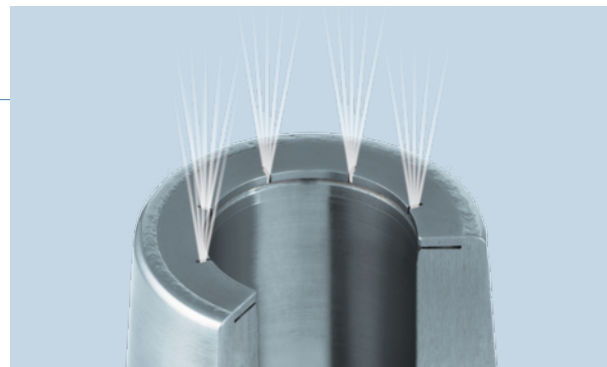

Optimized coolant bores with coolant outlet through slots
Cool Flash by HAIMER

Cool Flash vs. internal tool cooling		
	Cool Flash	internal tool cooling
Cooling range at the cutting edge	✓ 100%	✗ max. 30–40%
Tool stability	✓ maximum	✗ reduced
Application range	✓ variable	✗ per cutting tool
Diameter area	✓ from 6 mm	✗ from 12 mm
Acquisition cost	✓ per tool holder	✗ per cutting tool

Cool Flash

Cool Flash
Cool Flash Upgrade incl. Cool-Jet



Order No. 91.100.40
Order No. 91.100.41

COOLING SYSTEM COOL FLASH – SIMULATION

The goal of the development of the Cool Flash system was to transport the coolant directly to the cutting edges. Even for existing machine tools with an average pressure of approx. 20 bar, Cool Flash allows for reliable and precise cooling without any changes to the cooling system of the machine tool.

The graphic shows the optimized coolant supply to the cutting edges for different systems by comparing dependence of pressure and rpm. Even at low pressure and high rpm Cool Flash assures precise cooling. On competitive systems, higher rpm require higher pressure to generate effective cooling.

*Optimized coolant supply to the top of the cutting tool
(Protruding length: 28 mm, Tool Ø 6 mm)*

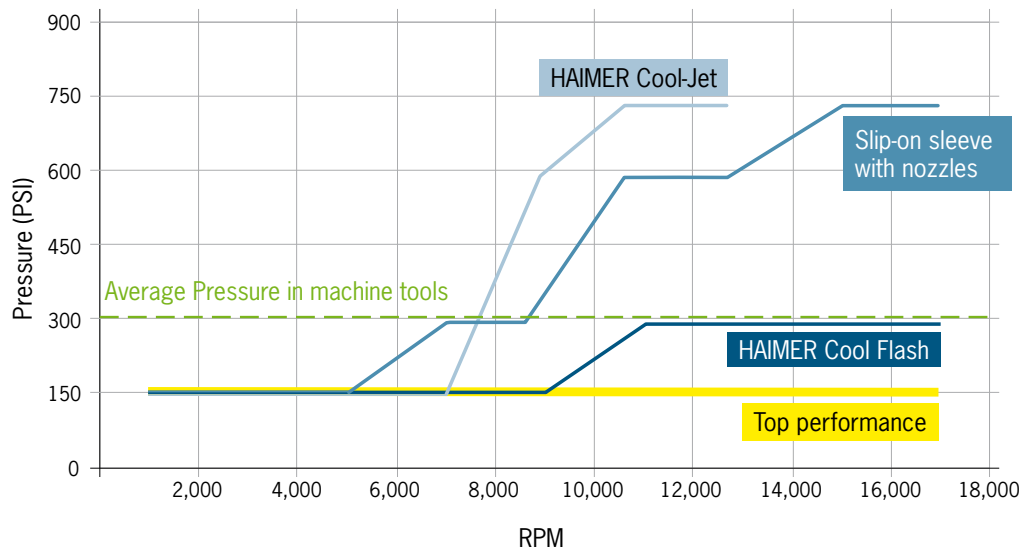

COOL FLASH COMPARED TO COMPETITIVE SYSTEMS

Test Results

Tool: Endmill (two flutes)
 Tool diameter: 20 mm
 Protruding length: 50 mm
 Pressure: 20 bar
 RPM: 12,000



Cool Flash – effective cooling at the cutting edges



Slip-on sleeve with nozzles – ineffective cooling, coolant does not reach the cutting edges



In high performance cutting (HPC), it is possible for the cutting tool to be pulled out of the chuck. The reason is a slow micro-creeping motion. It happens when cutting at high speeds and with high pull out forces. Even chucks with extremely high clamping forces cannot prevent micro-creeping. High-quality work pieces become scrap as a result. **The Safe-Lock™ system offers a solution.**

Drive keys in the chuck / collet grip in grooves in the tool shank. In addition to the frictional clamping forces of the tool holder, the tool is held using positive locking. As a result, micro-creeping is effectively prevented and your tool is clamped safely.

On the safe side with Safe-Lock™:

- For High Performance Cutting (HPC)
- Highly accurate clamping due to shrink fit technology
- High torque due to form closed clamping
- No loss of accuracy
- No pull out of the tool
- No spinning of the tool
- No damages on work piece or machine
- Groove on tool shank is directed so that tool will be pulled into the chuck (depending on direction of rotation)
- Patent granted: licensing for cutting tool manufacturers possible

The following tool manufacturers are licensed by HAIMER officially and offer their shank cutting tools with Safe-Lock™ grooves in the tool shank as a standard.



SAFE-LOCK® APPLICATION EXAMPLES



SAFE-LOCK™: Roughing application in the Packing machine industry

Problem:

- High tool wear on one flute (tool breakout)
- Only Weldon holders could be used

Target:

- Increase of tool life
- Usage of high precision tool holding instead of Weldon

Application: Contour milling

Material workpiece: Steel

Cutting tool: HPC solid carbide cutter with variable flutes, $\varnothing = 20$ mm, Z=4

Application parameters:

Cutting depth radial (a_e) = 10 mm,

Cutting depth axial (a_p) = 0.75xD,

Cutting speed (v_c) = 180 m/min,

Feed rate/flute (f_z) = 0.07 mm

SAFE-LOCK™

Equal width of the wear
marks at all four flutes

Weldon

Tool breakout on the opposi-
te side of the Weldon flat

Result

This comparison shows the wear characteristics of the cutting tools at various machining times. It is worth noting that, in the case of Safe-Lock™, even at double the machining time, wear is less prevalent and more controlled than for Weldon - **with 100% protection against pull-out.**



SAFE-LOCK™: Application in the aerospace industry at a large aircraft manufacturer in the USA

Problem:

- Low metal removal rate (especially for roughing)
- Low cutting tool life
- Expensive scrap at titanium and aluminium workpieces
- All tests with different systems failed: Milling Chucks, Press-Fit Chucks, Hydraulic Chucks or reinforced shrink fit chucks could not prevent cutting tool pull-out, despite higher clamping forces
- As a result they only used Whistle Notch / Weldon

Target:

- Needed to increase metal removal rate – especially for roughing
- Wanted to increase cutting tool life
- Increase of process reliability to avoid expensive scrap

Application: Roughing Titanium

Workpiece:	critical airplane component made of Ti6Al4V, a titanium alloy
Machine:	Vertical portal milling machine
Machine tool:	HSK-A100
Tool holder:	Shrink Fit Chuck HAIMER Safe-Lock™, Ø 32 mm, length 120 mm
Roughing,	
Fine machining:	one and the same coated solid carbide tool, effective cutting length of 83 mm

Result:

- Cutting tool was securely held due to Safe-Lock™ in all tests, no movement in the chuck during the entire machining process
- No danger of the tool being pulled out of the chuck
- Tool life more than doubled
- During roughing and finishing operations no vibrations, and consequently no chatter marks – unlike the Weldon chuck
- Significant productivity increases through the increase in material removal rates of **30%**

100% MORE TOOL LIFE WITH

SAFE-LOCK®

SAFE-LOCK® APPLICATION EXAMPLES



SAFE-LOCK™: Application at a leading provider in the industrial sealing technology

Problem:

- Tool pull-out at high precision tool holder
- Only Weldon holders could be used

Target:

- Process reliability in machining with highly precise tool holding

Application: Roughing VA Steel

Workpiece:	Gasket ring
Material:	1.4571 (VA)
Machine:	Mazak
Interface:	SK 40
Tool:	Solid carbide, variable flute end mill, Ø 16 mm

Application parameters:

Cutting Depth:	axial (ap) 19.8 mm
radial (ae) Slot	29.8 mm
RPM:	1194 rpm
Cutting speed (vc):	60 m/min
Feed rate/flute (fz):	0.2 mm/r

Result:

- With Weldon holder and tooling 50-70 parts per cutter
- With Safe-Lock™ 150 parts per cutter and no pull-out issue
- Machine runs much smoother with less vibrations

Test:

Weldon Holder Ø 16 mm, Length A = 80 mm

HAIMER Safe-Lock™ Power Shrink Chuck
40.445.16.37, Length A = 65 mm

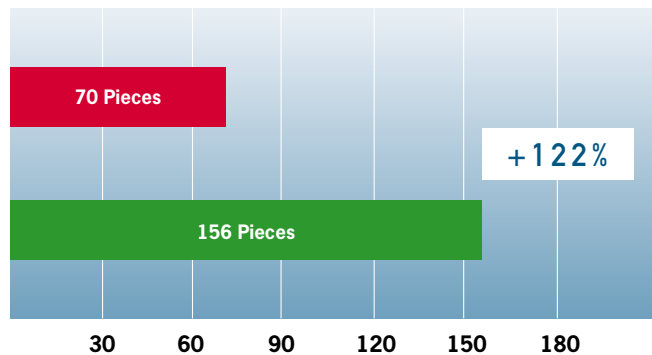

Test result: In the same time 86 pieces higher output i.e. increase by 122%

**HAIMER DEMO VANS:
TARGETED ADVICE ON-SITE.**



Our application engineers are true experts in the areas of shrinking and balancing technology. With one visit, they will be able to show you the potential benefits of using modern machining technologies from HAIMER.

- Targeted advice and demonstrations tailored to your specific needs
- Equipped with our cutting-edge shrink and balancing machines as well as HAIMER's latest tooling technologies
- On-site balance inspection of your tools – **for free**
- Balancing of holders, rotors (impellers, fans, housings, etc.), grinding wheels and tools of all types possible

Just ask for a visit and start profiting from our experts' experience! Our knowledge is your advantage!



THE MORE HAIMER, THE BETTER.



Passion for precision

HAIMER is a German, medium-sized family business. We develop and produce innovative ultra-precision products, primarily in the field of tool clamping. As the market leader in Germany, the continuous technological innovations of our products is very important to us and for this reason we annually invest 8–10% in research and development. With this budget, we can afford our own product development team, which Consistently works on practical innovations and continual product improvements. 13 sales and service subsidiaries guarantee the first class HAIMER service and specific customer orientated product consultation worldwide on the spot. However, all products are solely produced in Igenhausen, Germany. In accordance with our corporate philosophy: **Quality Wins.**

Our new North American Headquarters

Located in the Chicago suburb of Villa Park, HAIMER's new 25,000 ft² headquarters is designed and built to help facilitate the company's growth in the North American marketplace. It features state-of-the-art training facilities able to accommodate up to sixty people. The expanded showroom includes a CNC machining center for demo cuts, shrink fit and balancing machines under power, and HAIMER's complete range of tool holding solutions on display. Both the training facilities and showroom are wired with HD cameras for live and web-based presentations. From our new facility, HAIMER will also provide balance inspection, precision balancing and data chipping services for tool holders from HAIMER or any other manufacturer. Future service offerings will include end mill regrinding as well as Safe-Lock™ groove modifications.



HAIMER USA – Chicago, Illinois



HAIMER USA's Competency Center features a 60-seat Training Room



HAIMER's 25,000 ft² North American Headquarters includes a spacious customer lounge



HAIMER USA's new Showroom is equipped with the latest cutting edge technologies

TERMS OF DELIVERY AND PAYMENT

I. Generalities

The following conditions apply to all business transactions - also those in the future - with the customer. Our sales and shipping conditions apply exclusively; we do not recognize other conditions as well as especially contrary or otherwise differing conditions on the part of the customer, unless we explicitly approve of the validity of those conditions. Our sales and shipping conditions also apply in the event that we acknowledge contrary or differing conditions on the side of the customer and unreservedly fulfil the order. All agreements reached between ourselves and the customer must be in written form in order to be valid. Our sales and shipping conditions apply exclusively towards registered businessmen/businesswomen if the contract is integrated in operating their business and towards legal entities under public law and separate estates or assets under public law.

II. Prices/Price changes, shipping

- Our prices offered are Euro prices, and do not include value-added tax. Therefore, value-added tax must be added to the prices at the rate determined by the law applicable at the time. If not agreed specifically otherwise, our prices are ex works, excluding costs for packaging, postage, and shipping. All offered prices are subject to change.
- Our prices offered are applicable only for the dates of order upon which the offers are based. Subsequent changes or additions upon request or at the instigation of the customer, including additional costs incurred by the above, shall be charged additionally. The same applies for additional costs which might arise as the result of the above from machine down-time. In the event of changes in wages or material costs which arise either between making the offer and the placing of the order, or at any time exceeding four months following completion of contract, we reserve the right to adjust the price accordingly.
- Shipping of goods occurs at expense and risk of the customer and always plus cost of packaging following to the at any one time valid price list of Haimer or the relevant valid offer. Inasmuch as goods are shipped at cost and risk of the customer at the customer's request, our liability, as far as is legally permissible, is limited to damage caused intentionally or by gross negligence. At the customer's written request, and at his own expense, goods may be shipped insured by ourselves against theft, breakage, damage to or loss of goods in transit; fire and water damage, or against such other risks as may be expressed explicitly by the customer insofar as such are insurable.
- As far as can be reasonably expected on the part of the customer, partial shipments are permissible.

III. Payment

- The goods are to be paid in full, no deductions, within 30 calendar days of date of invoice.
- Bills of exchange are only accepted upon special agreement and on account of performance without allowance for discount. Discounting and bill charges shall be borne by the customer and become due for payment immediately. We are not liable for the timely presentation of a bill of exchange, its due protest, due notice, or the return of an unpaid bill, unless we or our vicarious agents are guilty of damage by intention or gross negligence.
- The customer is only entitled to set-off claims if his counterclaims have become res judicata, are uncontested or recognized by ourselves. In the event of contested counterclaims, the customer has no right of retention.
- In the case of uncontested counterclaims, the customer can only claim a right of retention regarding asserted claims which are based upon the same contractual relationship.
- With respect to this order the customer is obligated to confirm the receipt of the goods in cases of the delivery from Germany to the foreign countries of Europe; the confirmation has to comply with the regulation concerning turnover tax.

IV. Delay in Payment

- In the event of delay in payment, we are entitled to charge the legal rate of interest on overdue payments, i.e. the rate of 9 % plus the basic annual interest rate current at the time in question and a lump sum of EUR 40,00 per overdue amount; this notwithstanding, we explicitly reserve the right to assert claims regarding additional damages. If the rate of interest is not claimed firstly this shall not exclude a later enforcement in the frames of the legal limitation; in this regard a forfeiture is excluded.
- Should we become aware of circumstances which call into question the customer's creditworthiness and therefore deem our claim for payment to be at risk, particularly if the initiation of insolvency proceedings are filed for - or if insolvency proceedings are opened against the customer's property, or if a cheque is not honoured, or the customer stops payments respectively in extensive default of the payment with collection threat, then we are entitled to declare the residual debt due immediately and to demand immediate payment. Further, we are then entitled to demand advance payment or provisions of security, and to retain the goods until payment, advance payment, or provisions of security are made, and to discontinue processing running orders until the same. If a change of the order required by the customer affects the production time, we can claim for a new delivery time adjusted to the new circumstances. Delay of delivery or performance caused by force majeure, caused by circumstances that are beyond our control and caused by incidents which do make the delivery not only temporary difficult or impossible - this is especially strike, lock out, intervention of public administration, act of war, riots, lack of energy, destruction of our production and operating units, which were beyond our control as well as stoppage of transportation means, restrictions of work, also, even though this occurs at our supplier or their sub-supplier we are not responsible for even if we agreed on binding delivery deadlines. You allow us to prolong the delivery respectively performance time for the time of interference and an additional initial period. Additionally in such cases we have the right to adjust the price. The above mentioned circumstances do also fall beyond our control if they occur during a already existing delay. Begin and end of such interference will be communicated to the customer as soon as possible. The delivery time is observed in case the product left the premise or we communicated the readiness of shipment to the customer at the end of the delivery time.

V. Reservation of title

- Until all claims arising from the business relationship with the customer are fulfilled, the customer is required to grant the following securities, which we will release at the customer's request and at our own free will if the securities' value consistently exceeds that of the claims by more than 10%.
- All goods delivered to the customer remain our property until all claims arising from the business relationship with the customer are paid in full.
- The object delivered may be neither pledged nor transferred for security to a third party before it is paid in full. In the event of attachment by a third party to the object of delivery, particularly as a pledge, the customer shall refer to our ownership and inform us in writing immediately, so that we can enforce our rights of ownership. The customer is liable for costs which arise judicially or extra-judicially should the third party not be in a position to repay us such costs as arise in relation to the above mentioned.
- The customer is permitted to sell and process the goods within the context of proper business transactions, as long as he is not in arrears with fulfilling the claims which he owes. We can revoke this permission if the customer is overdue in payments or comes into a state of forfeiture of assets, particularly if insolvency proceedings are opened against his property.
- The processing or transforming of the goods by the customer shall always be done for us. In the event that the goods are joined, mixed, or blended with other items, we acquire co-ownership in proportion with the value of the goods (sum total of invoice including legal value-added tax) to the remaining items which were joined, mixed, or blended together at the time when they were joined, mixed, or blended together.
- For the event that ownership of the goods be lost inasmuch as the goods become an integral or necessary part of another item, the customer hereby concedes to us now, in advance, co-ownership of the main item equal to the share which corresponds with the proportion of the value of the goods delivered (sum total of invoice including legal value-added tax) to the value of the main item at the time of said joining, mixing, or blending.
- In the event that the goods are sold, the customer now and hereby, for the security of our claims arising from the whole of the business relationship, assigns all claims which arise for the customer from resale or from other legal grounds (insurance, tortious act, or the like) against the buyer or third parties, independently of whether the goods, of which we have (partial) ownership, are resold with or without processing. Upon our request, which may be made at any time, the customer must inform us regarding the state of the claim, and allow us or anyone authorized by us to inspect those business records relevant to the above. We grant the customer permission, subject to revocation, to collect the sums due for the claims we assigned, to his own account and in his own name. This direct debit authorization can only be revoked if the customer does not meet his financial obligations in a proper manner. Our authority to collect ourselves the sums due remains unaffected by the above. However, we bind ourselves not to collect the sums due as long as the customer meets his financial obligations with the collected sales revenue, is no overdue for payments, and especially if no initiation for insolvency proceedings has been filed or cessation of payments has been noted. If this is the case, however, we can require that the customer makes known to us immediately the claims assigned and their debtors, including all information required for collection purposes, providing us with all records necessary therefore, and informing the debtors (third parties) of the assignment of claims. We as well have the right of disclosure of assignments against debtors. The customer, however, is not entitled to assign this claim to third parties.
- Contrary to position 3, the customer is not entitled to sell the goods, even within the context of proper, standard business transactions, if the customer excludes assigning claims based on the sale of the goods to us.
- In the event of actions contrary to the terms of contract, particularly in the case of delay of payment, we are entitled to rescission of the contract. Following rescission, we can demand return of the goods from the customer.

VI. Delivery time

- Delivery dates and delivery periods are only binding if they are confirmed by us explicitly in writing.
- The confirmed delivery dates and delivery periods start when the following cumulative conditions are met: the clarification of all technical questions; the fulfilment of the customer's contractual obligations, particularly that of furnishing records, authorizations, and release statements. When alterations ordered by the customer have an influence upon the duration of production time, we are entitled to insist upon agreeing to a new delivery time which is adjusted to the changed circumstances. We are not liable for delays in delivery and performance, even if binding dates and times have been agreed upon, in case of acts of God, in case of circumstances which we are not responsible for, and in the event of incidents which not only temporarily substantially impede delivery or make it impossible - this includes in particular strike, lock-out, sovereign intervention, acts of war, riots, electrical shortage, destruction or damage to our production or works fixtures for which we are not liable, as well as transportation failure, work limitations etc., also when the above affect our suppliers or their sub-suppliers. Such circumstances entitle us to postpone delivery or performance for the duration of the impediment plus a reasonable starting-up time. Furthermore, such a case entitles us, for our part, to adjust the price accordingly. We are also not liable for the circumstances mentioned if they arise during an already existing delay. In important cases, we will inform the customer as soon as possible regarding the beginning and end of such hindrances. The delivery deadline is met if by date of its expiry the goods have left the works or the customer has received notice of readiness of dispatch.

VII. Sample

Samples of all kinds, whether designs, models, etc., are prepared especially for the customer according to his instructions and only by prior written commission for the same. In every case, these samples will be billed separately to the customer.

VIII. Storage of documents and items for further use

The storage of the customer's papers and other objects such as may serve some future purpose is undertaken only upon prior written agreement and in exchange for special compensation beyond the date of delivery of the goods ordered. The above mentioned goods a/o objects, if they are placed at our disposal by the customer, shall be handled with care up to the delivery date. In this case as well, storage beyond the delivery date is only granted upon prior written agreement and in return for special compensation. Should the above mentioned documents a/o objects be insured against water, fire, theft, or other dangers, the customer must provide the necessary insurance himself. Further, within legally permissible limits, we are exempt from liability for the loss of, damage to, or destruction of these documents a/o objects.

IX. Company print

On objects of our manufacture, we can, with the customer's permission, make reference to our company in an appropriate manner. The customer can only withhold his permission in the event that he has a justifiable interest in so doing.

X. Time limit for making a claim

Upon delivery, the customer must inspect the goods without delay, and in the event that the goods have obvious defects, these must be reported to us within a period of two weeks following receipt of the goods, in the case of shipping from the point of taking delivery from the shipper or carrier; otherwise, the customer's claims regarding defects are excluded. Claims for non-obvious defects can only be asserted within a period of one year upon receipt of the goods, in the case of shipping upon taking delivery from the shipper or carrier.

XI. Warranty

The warranty period is 1 year after passing of the risk. In the event of defects, we are entitled to choose between rectifying the defects or delivering a substitute, up to the amount of the contractual value, unless we or our vicarious agents are guilty of damage by intent or gross negligence, or if we have given a guarantee for the condition of the goods. If two attempts at rectifying the defects or at delivering a substitute fail, or if rectification or substitution is not possible, not to be reasonably expected for the customer, or finally refused by ourselves, then the customer can demand a reasonable reduction in price or withdrawal from the contract. For substantial third-party products, our liability is limited initially to the assignment of liability claims to which we are entitled against the supplier of the third-party products. Any liability ensuing on our part in this instance can only be secondary and requires prior recourse to the courts for the supplier of the third-party product. We will reimburse such costs as may arise if they cannot be collected from the supplier and if they were necessary for prosecution. Guarantee and damage claims which exceed the above are excluded, so far as is permissible by law.

XII. Compensation for Damages

The following liability limits apply for damage claims, within the parameters of the law:

For all damages arising from culpable breach of contract, we are liable if we ourselves or our vicarious agents are at fault, but only in case of damage by intention or gross negligence. Within the limits of the law, this also applies in cases of default or when performance becomes impossible. Insofar as we are considered liable for damages due to breach of contract which results from a slight degree of negligence on our part or on the part of our vicarious agents, liability for indirect damages is excluded. When delay damages arise due to delay in our performance, we are only liable to the extent of contractual value (our own work excluding advance performance and material) if we or our vicarious agents are only at fault for slight negligence. This limitation of liability also applies for damages in connection with services of Haimer for goods of customers (e.g. Balancing, Cool Jet, Cool-Flash, Duo-Lock™ or Safe-Lock™), whereupon the liability is limited to the extent of the contractual value of the service by Haimer.

XIII. Taking Delivery; Passing of Risk

The customer must take delivery of the goods at the completion time agreed upon if the goods are ready for acceptance. If the customer is in default of acceptance, regardless of article III.1 the price agreed upon is due immediately. If the customer does not meet this obligation, we are entitled to withdraw from the contract and to make other use of the goods, whereby the sales revenues gained in this case are credited to the price agreed upon. We must be compensated for profit lost. If the seller is in default of acceptance or fails to perform other participation duties, then we are entitled to demand compensation for damages thus caused, including any additional expenditures which may arise. We reserve the right to further claims on our behalf. In case of default or delay in acceptance by the buyer, or other failure to perform participation duties on the part of the buyer, then the risk of accidental loss of the goods or of accidental worsening of the state of the goods passes over to the buyer from the point in which he entered into the state of default in acceptance or debtor's delay.

XIV. Ownership, Copyright, Duty of Secrecy

Those articles of the trade which we use to manufacture the product of the contract, in particular special means of operation (tools, devices) remain our property and shall not be delivered. We reserve for ourselves the ownership and copyrights of estimates of cost, drawings, and other documents. They may only then be made available to unauthorized third parties if we give our prior explicit written permission. The customer is solely liable if, in the process of executing orders, any rights, particularly copyrights, trademarks, or patents of third parties are infringed upon. The customer indemnifies us against claims of third parties in the event of such violations of rights. All ideas and documents drawn up by ourselves, in particular samples, sketches, designs, technical information, models, technical drawings etc. are under the protection of our intellectual property, have to be treated confidential and may not be used or applied in any manner without our prior written consent.

XV. Export

The customer (Buyer) confirms if he resales Haimer products that he complies with all provisions and regulations of German and international export controls as well as with the US re-export regulations. The customer (Buyer) declares with his order his compliance with this kind of laws and regulations. Additionally the customer (Buyer) confirms with his order that the products will remain in the delivery country respectively will not be delivered out of the European Union.

XVI. Applicability of German Law

The law of the Federal Republic of Germany is exclusively applicable. Application of the UN Convention on Contracts for the International Sale of Goods, dated January 1, 1991, is precluded.

XVII. Place of Performance, Place of Jurisdiction, and Validity

The place of performance for all claims arising from this contractual relationship is Igenhausen. Augsburg is the place of jurisdiction for all legal disputes arising from this business connection. We are, however, entitled to bring grievances before the legal place of jurisdiction as well. The partial or complete invalidity of any provision in these terms of sales and delivery, or of any provision within the context of other agreements, whether now or in the future, shall not affect the validity of any part of the remaining provisions or agreements. The invalid provision is then replaced by that lawfully permissible provision which is closest to the meaning of the invalid provision.

HAIMER[®]
Quality Wins.



Tooling Technology

Shrinking Technology

Balancing Technology

Measuring Instruments

Tool Management

Haimer USA, LLC | 134 E. Hill Street | Villa Park, IL 60181 | USA

Phone (630)833-1500 | Fax (630)833-1507 | Mail: haimer@haimer-usa.com | www.haimer-usa.com

Haimer Mexico | Anillo Vial Fray Junipero Serra No. 16950 Bodega 2 | Micro Parque Industrial Sotavento

Querétaro., QRO. C.P 76127 | Mexico | Phone +442-243-09 50 | www.haimer-mexico.com | haimer@haimermx.com