

HAIMER®
Quality Wins.

TOOL DYNAMIC BALANCING MACHINES



www.haimer-usa.com

CONTENT



HAIMER Tool Dynamic Balancing Technology	Page
Why should I buy a Balancing Machine?	4
Case Studies	6
Why balance grinding wheels	8
How to balance grinding wheels	9
Modular Balancing System	
TD 1002	10
TD Economic	12
TD Economic Plus	14
TD Comfort	16
TD Comfort Plus	18
Optional Configurations	
Control Terminal and Tool Dynamic TD Software 4.0	
Tool Dynamic Control Terminal	24
Tool Dynamic TD Software 4.0	25
Tool Balancing and Presetting	
TD Preset	26
Special Balancing Machines	
TD 800	28
Automatic Balancing Technology	
TD Automatic	30
Application Examples	
Accessories	
Runout measuring device	37
Balancing adapter	38
Balancing rings/Set of balancing screws	43
Balancing arbor	44
Tool Management	
	45

THE TOOL DYNAMIC ADVANTAGES

1.

Enable the full potential of your machine tool

- Higher RPM
- Higher cutting capacity
- Better surface finish



2.

Protect your machine tool

- Less vibrations
- Lower wear on bearings
- Higher spindle life time
- Quality control purchasing allegedly pre-balanced tool holders
- Preservation of warranty in case of machine tool spindle damages



3.

Reduce your machining costs

- Less downtime
- Higher process reliability



4.

Correct and easy balancing

- Software extremely user-friendly
- Not only for balancing experts



5.

HAIMER as your system provider around the machine tool

- Single source solutions in perfect harmony
- Balancing – Clamping – Automation

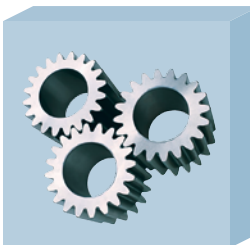

!

With balanced tools you save money fourfold

- Higher cutting volume
- Longer spindle lifetime
- Longer tool life
- Increased workpiece precision

“I’m only running tools at 1,500 RPM. Is balancing really necessary?”

Although there is a greater benefit to balancing holders when running at high spindle speeds, there is always a benefit to having balanced tool holders, even at low spindle speeds.

- We’ve all experienced situations, where we are limited on the speed at which we can run certain cutting tools. Whether it’s because of the sound that the machine tool makes with the increased speeds, or whether it’s the dramatic decrease in cutting tool life with increased speeds, chances are good that this limit we put on the spindle speed, is due to the unbalance within the tool holder assembly. There have been many cases, where after balancing the assembly, we were able to decrease the cycle time, due to the increase in speeds & feeds once the tool holder assembly had been balanced.

“We purchase tool holders that are Pre-Balanced. Is this good enough?”

Purchasing pre balanced tool holders is generally a good idea. However:

- What happens when you clamp a cutting tool into a balanced tool holder? Cutting tools are sometimes asymmetrical (example: flats on the shank) which will add unbalance to the assembly.
- Most tool holder manufacturers stock product in a “Pre-Balanced” condition. A pre-balanced condition means that the tool holders are fully balanced without components such as cutting tools, pull studs, collets, clamping nuts, moveable bearings, data chips, etc... Once these other components are added to the tool holder assembly, the tool holder may need to be re-balanced in order to conform to ISO balance specifications.

“I don’t need balanced tool holders.”

Modern milling machines operate with high spindle speeds. An unbalance causes centrifugal forces. The centrifugal forces increase squared to the spindle speed. Older machines have spindle speeds of about 2,000 rpm. Even at 10,000 rpm the unbalance in the same exact tool holder causes a centrifugal force that is 25 times higher.

- The centrifugal force stresses the spindle bearings. The lifetime of the bearings decreases with excessive stress. Consequently, the spindle bearings become damaged and unnecessary repair costs are incurred.
- The manufacturers of milling machines and spindles specify the use of balanced tools. Often times, if unbalanced tools are used, there will be no warranty on the machine spindle.
- The direction of the centrifugal force is changing steadily as it rotates with the spindle. This is why centrifugal force causes vibrations.
- Vibrations shorten the life of the cutting tools. This causes higher cutting tooling costs and a decrease in the quality of the surface finish.



“Balancing is too complicated.”

It depends. Simple balancing systems often aren’t handled correctly because the operators don’t know the physical background of unbalance and balancing. Sometimes the existing unbalance is raised instead of reduced, since some balancing machines are not adjusted correctly for the specific tool. Overall it is rather difficult to have a specialist just for balancing. However, this is not necessary.

With a good machine, balancing is simple. The operator only has to choose the type of tool he or she wants to balance. From then on the machine tells them what to do. The machine has the expert knowledge and not the operator.



“The tool holders that I buy are already balanced.”

Generally a good idea. The manufacturer of tool holders normally can balance quicker and more efficiently. However:

- What happens when you clamp a cutting tool into a balanced tool holder? The cuttings tools often are unsymmetrical (e.g. side lock shanks). Many tool holders have movable parts which can have different positions after being mounted (e.g. pull studs, clamping screws, bearing races, collets, locknuts). Tool holders for high speed machining should always be balanced when mounted as one complete set-up (tool holder, pull stud, collet, cutting tool, etc.). Once tool holder elements have been modified, the balance level changes.
- What about the tool holders which are already in your factory? It is nearly impossible to avoid a mixing up of balanced and unbalanced tool holders. One single process with an unbalanced tool at high spindle speed can damage the spindle bearings. This is why the “old” tool holders should be balanced as well.
- How do you know your tool holders are balanced? After all, when one receives a shipment from a vendor they first check the items in the box and insure that selection and quantity of the items in the box is correct. Why not check that the balance of the tools is correct as well? What balance level does your “pre-balanced” tool holders come to you? Checking the balance of tool holders should always be part of the quality control of incoming goods, particularly if you are paying a premium for “fine-balanced” tools.

“I only have a few parts to balance. For this purpose a simple machine is sufficient.”

When balancing is not done regularly, the operators have no experience. The risk of incorrect measurement due to improper handling of the machine is very high. Therefore, in such cases, it is important to have a balancing machine that guides the user through the procedure. Plus, it would be unfortunate to have an inferior balancing machine that limits your balancing potential for the future.

“How expensive is a balancing machine?”

A balancing machine is an investment, and an investment must be efficient in order to be justified.

“A balancing machine is too expensive for me.”

A balancing machine is an investment. An investment must be efficient. The purchasing price has only a small influence on the efficiency of an investment.

A balancing machine is efficient, when:

- the process reliability in the production can be improved
- the life time of the spindle can be extended. (One single replacement of a spindle costs more than a balancing machine)
- the frequency of the downtime of the machines is decreased.
- The most expensive factor in a production is machine standstill
- the result of the production is improved – better surface finish
- the maximum spindle speeds and feeds can be utilized on your machine – quicker throughput
- the tool life is extended
- the cutting capacity is improved.

Overall, it is most important that a balancing machine is easy to handle and that it gives you trusting and repeatable results. Ultimately, it should provide the easiest method to find your desired balance level to run at a safe and productive rate in your facility. It is possible to get all of that with a balancing machine that is easy and secure to handle, insuring that you reach the desired results.

COST REDUCTION BY THE USE OF BALANCED TOOL HOLDERS (PER MACHINING CENTER)

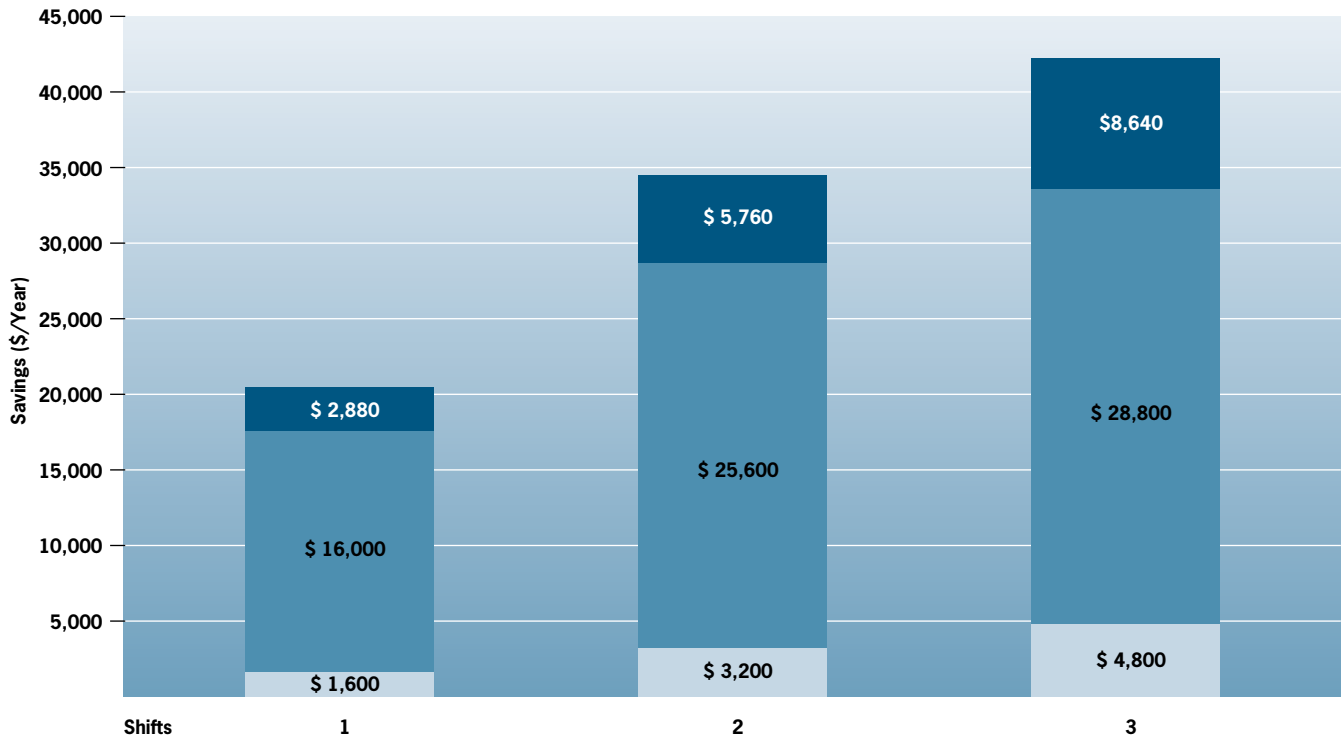

- Savings by raising spindle lifetime by 100%
- Savings by raising cutting volume by 10%
- Savings by extending tool life by 10%

Basics of the calculation	runtime h/year	cost rate \$/h	tooling costs \$/h
1 shift	1,600	100	10
2 shifts	3,200	80	10
3 shifts	4,800	60	10

Spindle lifetime (n_{max} = 15,000 rpm):

Tools not balanced: 5,000 hrs.
 Tools balanced: 10,000 hrs.
 Cost for spindle replacement: \$ 18,000

Not taken into account:

- Improved surface quality
- Costs for unplanned downtime of the machine (spindle replacement)
- Improved accuracy
- Real savings may be much higher than calculated

ON THE SAFE SIDE: BALANCE YOUR TOOLS QUICKLY AND EFFICIENTLY WITH THE TOOL DYNAMIC SYSTEM

Reliable, quick and efficient – the perfect balancing system for tool holders, grinding wheels and other rotors.

- Flexibility for future requirements due to modular construction
- 4 versions available, offering a perfect solution for every need
- Balancing in 1 or 2 planes
- Unique high precision spindle taper adapter system with automatic clamping for all common tooling systems and tapers
- Highest measuring accuracy and repeatability
- Even low cost chucks (steep taper with low precision) can be clamped accurately due to elastic centering
- Adapters for rotors with a center bore (e.g. grinding wheels)
- Unbalance correction by drilling, milling, balancing rings and weights
- Unbalance correction using fixed components (e.g. balancing screws in threads)
- Easy service due to modular construction with plug connectors
- Calibration function for testing equipment control according to ISO 9001
- Single machine calibration for all tools thanks to hard bearing technology (force measuring vertical balancing machine)

Simple and self-explanatory operation. User friendly menu guidance on PC screen or integrated display. All languages possible.

- Excellent relationship between price and efficiency
- Multiple methods of measuring: simple measuring – index measuring – measuring with spindle compensation – measuring with zero setting
- Tool management for more than 5,000 tools, storing the most recent balancing results
- Interface to the local computer network
- Input of balancing tolerance in balancing quality grades (G or Q)
- Graphically displayed measuring results
- Printout of measuring results on label or certificate
- Clear indication if balancing tolerance has been reached
- Indication of actual balancing quality grade and permissible spindle speed
- Optical indexing aid: actual position of unbalance visible on screen
- Automatic positioning of spindle at position of unbalance
- Optical laser marks the position of unbalance directly on the tool
- Error diagnosis
- Density function with an integrated list of materials with different specific weights.

Test Data Example

(Completed by a major auto parts supplier in South Carolina)
DR2002 FLCA machine Cast Iron/Tool #607 (Drilling/Boring/Facing Tool)



	Before Balance	After Balancing	Comment
Tool Life	250 Pieces per edge	350 Pieces per edge	100 pc increase
Surface finish	20 Rz	15 Rz	5 Rz finer finish
Bore Size and roundness	From Pre-setter + .055	From Pre-setter 0	Cut to set size
Vibration Analysis Results	1.821 mm/sec.	.051 mm/sec.	Lowered 1.77

Before Balance:

This tool would not consistently reach its full life (inserts would fail).

After Balance: This tool reached its full life 100% of the time.

Future Expectations include:

- Increase in tool life plant wide/better surface finishes/controllable bore dimensions.
- Spindle bearing failure decrease plant wide.
- Decrease in premature tool failures.
- Overall tool performance, repeatability, chatter reduction, and scrap reduction.

Summary:

As nearly all machine tool manufactures recommend the tools used in their spindles should be balanced to G2.5 at all rpm ranges, not all tools require balancing. Determination should be made using a tool by tool method considering the following: tool rpm, tool weight, tool operation, stress applied to the spindle and application trouble shooting. Testing has proven that balancing tools at any rpm range can yield positive results, even below 8,000 rpm.

WHY BALANCE GRINDING WHEELS?

Why balance grinding wheels?

Dressing ≠ Balancing

Balancing of grinding wheels is essential despite dressing them!

Causes of unbalance on a grinding wheel:

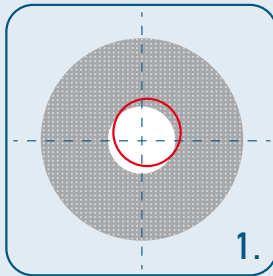

1.

1. Tolerance of the grinding wheel bore
- Tolerance of the grinding wheel arbor

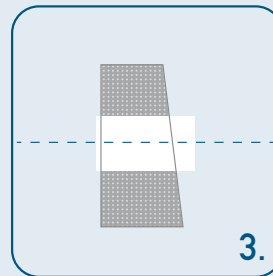

3.

3. Parallelism of the grinding wheel
- Wear of the grinding wheel

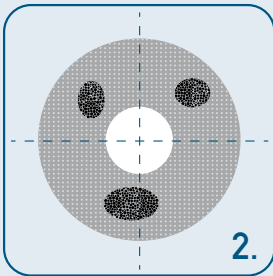

2.

2. Homogeneity of the grinding wheel
- Dressing of the grinding wheel

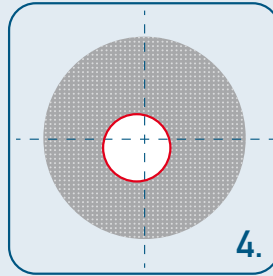

4.

4. Concentricity of the grinding wheel
- Profiling of the grinding wheel

Consequences of unbalance

1. Reduced surface quality → Chatter marks
2. Reduced dimensional accuracy on the work piece → Increased costs for wheel dressing
3. Extremely high grinding wheel wear → Reduced tool life
4. Spindle head wear out → danger of machine down time → unnecessary repairs → expensive inspections

As a result, the grinding parameters are reduced and productivity is decreased

HOW TO BALANCE YOUR GRINDING WHEELS CORRECTLY!

Guideline for initial balancing of a new grinding wheel pack

Step 1

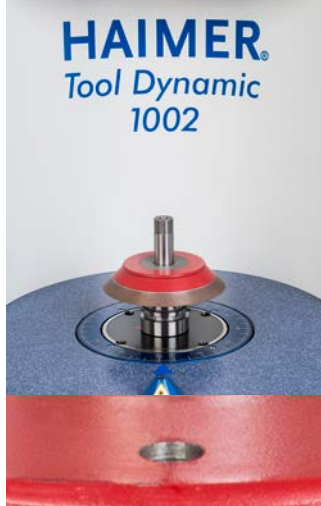

1. Add first grinding wheel on arbor
2. Add spacer
3. Tighten nut
4. Measure unbalance
5. Correct unbalance (e.g. by axial drilling)

Step 2

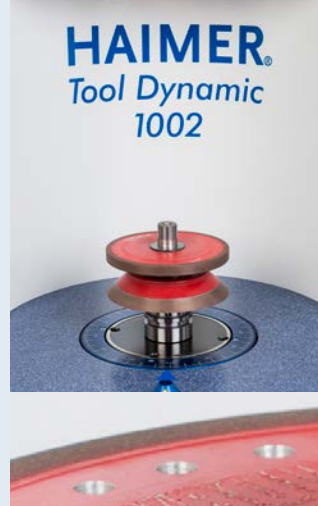

1. Add 2nd grinding wheel to arbor
2. Add position reference marking on both grinding wheels
3. Tighten nut
4. Measure unbalance
5. Correct unbalance (e.g. by axial drilling)

Step 3



1. Add 3rd grinding wheel to arbor
 2. Add position reference marking on all three grinding wheels
 3. Tighten nut
 4. Measure unbalance
 5. Correct unbalance (e.g. by axial drilling)
- **Pre-balancing finished**

Step 4



1. Dressing of complete grinding wheel
 2. Measure unbalance
 3. Correct unbalance (e.g. by balancing screws s. page 15/18)
- **Fine-balancing finished**

Tool Dynamic TD 1002: For minimalists

Runout Measuring device
for TD 1002 see page 37



Picture shows TD1002 with runout measuring device (optional)

TOOL DYNAMIC TD 1002 MODULAR BALANCING SYSTEM











Balancing machine for balancing tools, tool holders and grinding wheels on 1 or 2 planes (optional).

- Force measuring table and complementary machine
- Ideal for mold makers
- For small batch lots, single application, standard chucks and grinding wheel packages
- Adapter with automatic clamping system

Features:

- Menu-based handling – via integrated user interface and display
- Safety hood with automatic door lock
- Special high precision spindle bearings

Characteristics

	Vibration optimized base	Adapted table for optimized base
	User interface	Integrated user interface for easy handling of the machine
	Optical indexing help 80.204.00	Indication of the exact spindle angle position on display
	Laser marking	Indicates the position of unbalance and correction with a laser
	Radial drilling	Balancing by drilling radially
	Software for compensation with balancing rings	Balancing by rings or other movable weights
	Index balancing	Compensation of measuring errors by index balancing (2 measuring runs, indexing angle 180°)
	Balancing with spindle compensation	Quick and precise measurement of repetition parts (single measuring run)
	Balancing in 1 plane	Measuring and correction of unbalance in 1 plane (static)
	Deutsch/English/Français/ Italiano/Español	Languages for user interface
	Accessories and special equipment	Please check the table on page 20

Technical details

Tool Dynamic TD 1002

Dimensions l x h x d [mm/inch]	500x680x820 / 20x27x32	Power usage [kW]	0.4
Weight [kg/lbs]	200/441	Compressed air [bar/psi]	6/87
Spindle Speed [rpm]	600–1100	Max. tool length [mm/inch]	360/14.2
Measuring accuracy	< 1.0 gmm	Max. tool-Ø [mm/inch]	340/13.4
Power requirements [V/Hz]	230/50-60	Max. tool weight [kg/lbs]	15/33
	(comes with 110V transformer)	Order No.	80.250.00.US

Technical data subject to change without prior notice

Tool Dynamic TD Economic: For beginners











TOOL DYNAMIC TD ECONOMIC MODULAR BALANCING SYSTEM







Your introduction to the modular balancing system Tool Dynamic TD. The Tool Dynamic TD Economic measures and corrects the unbalance in one plane (static).

The TD Economic is perfect for balancing short tool holders and tools because of the couple unbalance being very low. Easy handling with integrated keyboard and screen.

The following characteristics are identical to Tool Dynamic TD 1002:

Characteristics					
	User interface		Radial drilling		Balancing with spindle compensation
	Optical indexing help 80.204.00		Software for compensation with balancing rings		Balancing in 1 plane
	Laser marking		Index balancing		Deutsch/English/Français/ Italiano/Español

The following characteristics are included standard for Tool Dynamic TD Economic:

Characteristics			
	Base made of polymer concrete	Heavy base ensures the highest measuring accuracy	
	Fixed components 80.202.00	Enables balancing at predefined positions, e. g. with balancing screws	
	Automatic indexing 80.217.00	Turns the spindle on the selected angle position and simplifies exact positioning of spindle	
	Rack for accessories 80.227.00	Storage rack with two integrated drawers for balancing adapters and further accessories	
	Balancing software TD 4.0 80.245.06	New software with user-friendly graphical interface and touchscreen control	
	Accessories and special equipment	Please check the table on page 20	

Technical details			
Tool Dynamic TD Economic			
Dimensions l x h x d [mm/inch]	500x1500x820 / 20x59x32	Compressed air [bar/psi]	6/87
Weight [kg/lbs]	450/990	max. tool length [mm/inch]	400/15.7
Spindle speed [rpm]	300-1100	Optional [mm/inch]	700/27.6
Measuring accuracy [gmm]	< 0.5	Max. tool diameter [mm/inch]	380/14.96
Power requirements [V/Hz]	230/50-60	Optional [mm/inch]	425/16.73
Power usage [kW]	0.4	Max. tool weight [kg/lbs]	30/66
Order No.			80.220.00.09.US

Technical data subject to change without prior notice

Tool Dynamic TD Economic Plus: For the advanced



TOOL DYNAMIC TD ECONOMIC PLUS MODULAR BALANCING SYSTEM



The new TD Economic Plus is perfect for measuring unbalance in two planes (dynamic). Long tools must be balanced in two planes to correct the couple or dynamic unbalance. Accessories can be clearly arranged in the built in drawers.

Work quickly and error free with laser marking, optical indexing help and automatic indexing of the spindle. The “fixed components” allow for balancing with screws via threaded bores.

The following characteristics are identical to Tool Dynamic TD Economic:

Characteristics					
	Base made of polymer concrete		Radial drilling		Balancing in 1 plane
	User interface		Fixed components 80.202.00		Automatic indexing 80.217.00
	Optical indexing help 80.204.00		Software for compensation with balancing rings		Rack for accessories 80.227.00
	Laser marking		Index balancing		Balancing software TD 4.0 80.245.06
			Balancing with spindle compensa- tion		Deutsch/English/Français/ Italiano/Español

The following characteristics are included standard for Tool Dynamic TD Economic Plus:

Characteristics		
	Balancing in 2 planes 80.252.01	Measuring and correction of unbalance in 2 planes (dynamic unbalance)
	Accessories and special equipment	Please check the table on page 20

Technical details			
Tool Dynamic TD Economic Plus			
Dimensions l x h x d [mm/inch]	500x1500x820 / 20x59x32	Compressed air [bar/psi]	6/87
Weight [kg/lbs]	450/990	max. tool length [mm/inch]	400/15.7
Spindle speed [rpm]	300-1100	Optional [mm/inch]	700/27.6
Measuring accuracy [gmm]	< 0.5	Max. tool diameter [mm/inch]	380/14.96
Power requirements [V/Hz]	230/50-60	Optional [mm/inch]	425/16.73
Power usage [kW]	0.4	Max. tool weight [kg/lbs]	30/66
		Order No.	80.222.00.09.US

Technical data subject to change without prior notice

Tool Dynamic TD Comfort: For the ambitious

















TOOL DYNAMIC TD COMFORT MODULAR BALANCING SYSTEM







If you want to use the Tool Dynamic frequently and keep the balancing time as short as possible, the TD Comfort machine is right for you. It is equipped with a PC, keyboard, mouse and monitor. The large screen enables fast tool data entry with an intuitive graphical display of unbalance – you just balance faster!

In addition, the software of the machine offers the possibility to correct the unbalance with the help of a milling program, which is a very common method of correcting imbalance.

The following characteristics are identical to Tool Dynamic TD Economic Plus:

Characteristics					
	Base made of polymer concrete		Software for compensation with balancing rings		Fixed components 80.202.00
	User interface		Index balancing		Automatic indexing 80.217.00
	Optical indexing help 80.204.00		Balancing with spindle compensation		Rack for accessories 80.227.00
	Laser marking		Balancing in 1 plane		Balancing software TD 4.0 80.245.06
	Radial drilling		Balancing in 2 planes 80.252.01		Deutsch/English/Français/ Italiano/Español

The following characteristics are included standard for Tool Dynamic TD Comfort:

Characteristics	
	Print label Print balancing results on label
	Milling program 80.212.00 Milling program allows correction of unbalance via milling
	User account administration 80.245.12 User administration with individual allocation of user rights
	Screen holder 80.228.03.3 Comfortable tray to place PC-screen and keyboard
	TFT screen 80.229.02 Comfortable usage via keyboard for integrated PC (includes TFT screen, keyboard, mouse)
	Accessories and special equipment Please check the table on page 20

Technical details			
Tool Dynamic TD Comfort			
Dimensions l x h x d [mm/inch]	1100x1500x820 / 43x59x32	Compressed air [bar/psi]	6/87
Weight [kg/lbs]	450/990	max. tool length [mm/inch]	400/15.7
Spindle speed [rpm]	300-1100	Optional [mm/inch]	700/27.6
Measuring accuracy [gmm]	< 0.5	Max. tool diameter [mm/inch]	380/14.96
Power requirements [V/Hz]	230/50-60	Optional [mm/inch]	425/16.73
Power usage [kW]	0.4	Max. tool weight [kg/lbs]	30/66
Order No.			80.224.00.09.3.US

Technical data subject to change without prior notice

Tool Dynamic TD Comfort Plus: For perfectionists





Picture shows special equipment: Safety hood type 3 for tools with length up to 700 mm (see optional configurations from p. 20)

TOOL DYNAMIC TD COMFORT PLUS MODULAR BALANCING SYSTEM



The new Tool Dynamic TD Comfort Plus offers maximum ease of use and comfort. With the TD Comfort Plus, the balancing process is quick and seamless, allowing you to focus on your goals and objectives. Would you like to be able to balance your tools efficiently and fast – without being an expert?

The Tool Dynamic TD Comfort Plus is the ideal solution for you – optimized for touchscreen use, integrated PC, ergonomic storage for your balancing accessories and all the equipment needed to make balancing fast, convenient and very easy.

The following characteristics are identical to Tool Dynamic TD Comfort:

Characteristics		
 Base made of polymer concrete	 Software for compensation with balancing rings	 Automatic indexing 80.217.00
 User interface	 Index balancing	 Rack for accessories 80.227.00
 Optical indexing help 80.204.00	 Balancing with spindle compensation	 Milling program 80.212.00
 Laser marking	 Balancing in 1 plane	 Balancing software TD 4.0 80.245.06
 Print label	 Balancing in 2 planes 80.252.01	 User account administration 80.245.12
 Radial drilling	 Fixed components 80.202.00	 Deutsch/English/Français/Italiano/Español















The following characteristics are included standard for Tool Dynamic TD Comfort Plus:

Characteristics	
 Control terminal incl. touchscreen 80.233.00.4	Console for storage of touchscreen, keyboard, mouse, printer, and further accessories (only together with Balancing software TD 4.0)
 Accessories and special equipment	Please check the table on page 20

Technical details			
Tool Dynamic TD Comfort Plus			
Dimensions l x h x d [mm/inch]	1100x1500x820 / 43x59x32	Compressed air [bar/psi]	6/87
Weight [kg/lbs]	450/990	max. tool length [mm/inch]	400/15.7
Spindle speed [rpm]	300-1100	Optional [mm/inch]	700/27.6
Measuring accuracy [gmm]	< 0.5	Max. tool diameter [mm/inch]	380/14.96
Power requirements [V/Hz]	230/50-60	Optional [mm/inch]	425/16.73
Power usage [kW]	0.4	Max. tool weight [kg/lbs]	30/66
		Order No.	80.226.00.09.3.US













Technical data subject to change without prior notice

OPTIONAL CONFIGURATIONS

Symbol	Order No.	Article name	Description	TD 1002	Tool Dynamic TD				TD 800
					Economic	Economic Plus	Comfort	Comfort Plus	
	80.205.00	Transformer	Transforms 230 Volt single phase power to 110 Volt single phase						
	—	Vibration optimized base	Adapted table for optimized base	●	—	—	—	—	—
	—	Base made of polymer concrete	Heavy base ensures the highest measuring accuracy	—	●	●	●	●	●
	—	User interface	Integrated user interface for easy handling of the machine	●	●	●	●	●	●
	—	Optical indexing help	Indication of the exact spindle angle position on display	●	●	●	●	●	●
	—	Laser marking	Indicates the position of unbalance and correction with a laser	●	●	●	●	●	●
	—	Print label	Print balancing results on label	—	○	○	●	●	●
	—	Radial drilling	Balancing by drilling radially	●	●	●	●	●	●
	—	Software for compensation with balancing rings	Balancing by rings or other movable weights	●	●	●	●	●	●
	—	Index balancing	Compensation of measuring errors by index balancing (2 measuring runs, indexing angle 180°)	●	●	●	●	●	●
	—	Balancing with spindle compensation	Quick and precise measurement of repetition parts (single measuring run)	●	●	●	●	●	●
	—	Balancing in 1 plane	Measuring and correction of unbalance in 1 plane (static)	●	●	●	●	●	●
	80.252.01	Balancing in 2 planes	Measuring and correction of unbalance in 2 planes (dynamic unbalance)	○	○	●	●	●	●
	80.202.00	Fixed components	Enables balancing at predefined positions, e.g. with balancing screws	○	●	●	●	●	●

Technical data subject to change without prior notice





















● included ○ optional — not available

Symbol	Order No.	Article name	Description	TD 1002	Tool Dynamic TD				TD 800
					Economic	Economic Plus	Comfort	Comfort Plus	
									
	80.217.00	Automatic indexing	Turns the spindle on the selected angle position and simplifies exact positioning of spindle	○	●	●	●	●	●
	80.227.00	Rack for accessories	Storage rack with two integrated drawers for balancing adapters and further accessories	—	●	●	●	●	●
	80.212.00	Milling program	Milling program allows correction of unbalance via milling	○	○	○	●	●	●
	80.245.06	Balancing software TD 4.0	New software with user-friendly graphical interface and touch-screen control	—	●	●	●	●	●
	80.228.03.3	Screen holder	Comfortable tray to place PC-screen and keyboard	—	○	○	●	—	—
	80.228.02.01.3	Printer desk	Optional desk for printer (Requires screen holder)	—	○	○	○	—	—
	80.228.02.02.3	PC holder	Optional holder for external PC (Requires screen holder)	—	○	○	○	—	—
	80.233.00.4	Control terminal incl. touchscreen	Console for storage of touchscreen, keyboard, mouse, printer, and further accessories (only together with Balancing software TD 4.0)	—	○	○	○	●	●
	80.229.03	Touchscreen	TFT monitor with touchscreen	—	—	—	○	●	●
	80.229.02	TFT screen	Comfortable usage via keyboard for integrated PC (includes TFT screen, keyboard, mouse). Only together with Balancing software TD 4.0	—	○	○	●	—	—
	80.229.04	Touchscreen	Package for comfortable usage via touchscreen for integrated PC (includes sophisticated 19" touchscreen, keyboard, mouse). Only together with Balancing software TD 4.0	—	○	○	—	●	●
	80.209.00	Specific weight function	Enables specification of the specific weight of the holder to be balanced, if different from steel	○	○	○	○	○	○
	80.213.01	Drilling axial	Enables balancing by axial drilling, e. g. for grinding wheels	○	○	○	○	○	○

Technical data subject to change without prior notice



● included ○ optional — not available

OPTIONAL CONFIGURATIONS

Symbol	Order No.	Article name	Description	TD 1002	Tool Dynamic TD				TD 800
				Economic	Economic Plus	Comfort	Comfort Plus		
									
	80.218.00	Index balancing with free indexing angle	Index balancing of holders which can not be indexed 180° (e. g. Capto chucks)	○	○	○	○	○	
	80.214.00	Software for printout of report	Printout of a detailed measuring protocol (balancing certificate)	○	○	○	○	○	
	—	Deutsch/English/ Français/Italiano/ Español	Languages for user interface	●	●	●	●	●	
	80.245.12	User account administration	User administration with individual allocation of user rights (80.245.06 required)	—	○	○	●	●	
	80.245.09	Forbidden areas	Defined areas that are not allowed for the correction of the unbalance (80.245.06 required)	—	○	○	○	○	
	80.245.10	Alternative balance correction positions	Calculation of alternative positions, when proposed position not possible (80.245.06 required)	—	○	○	○	○	
	80.245.11	Optimized measuring time	Shortened measuring run, if measuring accuracy is sufficient (80.245.06 required)	—	○	○	○	○	
	80.245.14	Eccentric Balancing	Correction of unbalance by eccentric milling or turning	—	○	○	○	○	
	80.232.01	Safety hood type 3	Safety hood for extra long tool holders with max. 700 mm length and max. 400 mm diam. (incl. second laser marking from top)	—	○	○	○	○	
	80.232.02	Safety hood type 4	Safety hood for extra long tool holders with max. 700 mm length and max. 425 mm diam. (incl. second laser marking from top)	—	○	○	○	○	
	80.254.00	Runout measuring device	Easy and reliable check of grinding wheel's runout and axial runout	○	—	—	—	—	
	80.203.00	Balancing screw set	Set consisting of 11 × 10 special screws for fine-balancing of tool holders with balancing threads m6 (e. g. shrink fit chucks from HAIMER)	○	○	○	○	○	
	79.350.xx	Balancing rings	For fine-balancing of all tool holders with cylindrical outer diameter (see p. 43)	○	○	○	○	○	
	80.207.01	Precision scale	For highly precise weighing of balancing weights	○	○	○	○	○	

Technical data subject to change without prior notice

● included ○ optional — not available

Symbol	Order No.	Article name	Description	TD 1002	Economic	Tool Dynamic TD Economic Plus	Tool Dynamic TD Comfort	Tool Dynamic TD Comfort Plus	TD 800
									
	80.207.12	Software scale integration	Automatic transfer of holder weight from scale	—	○	○	○	○	○
	80.207.10	Tool scale	Measures the weight of the tool holder, optional direct transfer into the balancing software (see option 80.207.12)	○	○	○	○	○	○
	80.215.02	Laser printer for balancing reports	Laser printer with Ethernet port to print out a detailed balancing report (together with option 80.214.00)	○	○	○	○	○	○
	80.206.00	Set of calibration magnets	Calibration magnets for testing, training, and demonstration purposes	○	○	○	○	○	○
	80.200.02	Product training	The training is obligatory for future warranty claims	○	○	○	○	○	○
	80.230.00	Calibration tube	For the calibration and testing of every balancing machine with the help of a defined mass	○	○	○	○	○	○
	80.228.02.04.3	Support arm for tool scale	Optional desk for tool scale	—	○	○	○	○	○
	80.245.13	Export measuring results	Software to export measuring results	—	—	—	○	○	○
	80.215.05	Label printer "Dymo"	Printout of a label with the measuring results (short report); USB interface (80.245.06 required)	—	—	—	○	○	○

Technical data subject to change without prior notice

● included ○ optional — not available

Tool Dynamic Control Terminal: For increased operating comfort

High quality touchscreen with hardened glass surface for easiest control

Traditional input with keyboard and mouse possible

Drawer for accessories

Storing Facility for printers

Storage for balancing adapter and tools

Additional drawer



TOOL DYNAMIC TD SOFTWARE 4.0

Intelligent balancing software

Balancing is now even easier and more user-friendly. The user interface is completely made up of graphics. Buttons with symbols replace the text fields in most locations. A selection can be made by using the function buttons, by clicking the mouse or by touching the screen.

The proven simple design of the old interface has been kept. Anyone who already knows the Tool Dynamic can work with the new software without any problems.

Additionally, there is a series of further functions with the TD Software 4.0

User management makes it possible to assign different access rights. For example, one user can create new tool data and determine balance tolerances while another may only call up the existing data and carry out the balancing procedure.

- User-friendly design
- Operation with touchscreen (optional)
- Allocation of balance tolerances by machine-type
- Tool management with database
- Tool data management in folder structure
- Simple data exchange with other systems, e.g. tool data management

Further options

- Definition of forbidden areas where the correction of the unbalance is not possible
- Calculation of alternative balancing positions
- User management with access rights
- Connection to external scales possible
- Optimized measuring times
- Export of measuring results

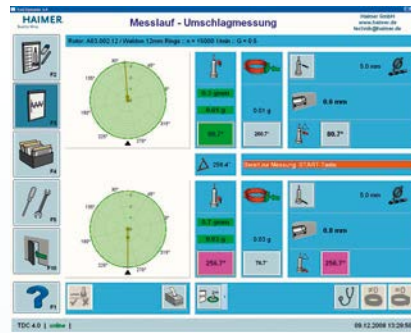

Clearly organized graphical user interface



Intuitive user guidance

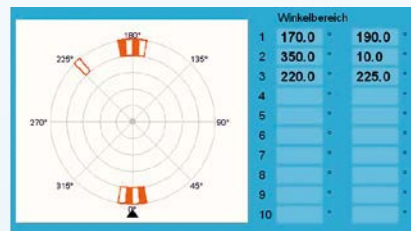

Feature: Forbidden Areas

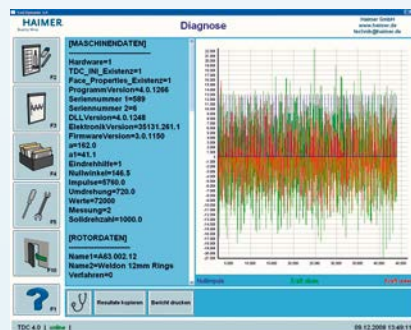

Advanced diagnostic modes

Tool Dynamic TD Preset: For individualists



TOOL DYNAMIC TD PRESET TOOL BALANCING AND PRESETTING

Two approved systems – a trendsetting innovation

Tool balancing and presetting are key elements of modern manufacturing. It is obviously a good idea to combine these two procedures. The Tool Dynamic TD Preset is a perfect combination of HAIMER's balancing and measuring technology. The tool is clamped in the high precision balancing spindle fitted with HAIMER's proven adapter system. This saves time and increases accuracy because the tool does not have to be re-clamped.

- Forward-thinking state-of-the-art technology
- Highest efficiency and time saved by combining two production stages
- Utmost precision due to high precision clamping in HAIMER's balancing adapters
- Reasonable price to efficiency ratio
- Compact design
- Simple and logical operation
- Adapter for all interfaces
- Highest possible measuring convenience

Order No. 80.240.00.US



Presetting

Measuring system with high resolution camera and digital photo processing



Software for professionals

Various options for measuring and balancing clearly arranged in menus

Technical details			
Tool Dynamic TD Preset			
Dimensions l x h x d [mm/inch]	1500x1800x820 / 59x71x32	Repeat accuracy [mm]	± 0.002
Weight [kg/lbs]	500/1102	Visual Indicator [mm]	0.001
Power requirements [V/Hz]	230/50-60	Compressed air [bar/psi]	6/87
Measuring system X-Axis [mm/inch]	200/7.87	max. tool length balancing [mm/inch]	700/27.6
Measuring system Z-Axis [mm/inch]	400/15.75	max. tool length measuring and presetting [mm/inch]	450/17.7
Spindle speed [rpm]	300-1100	Max. tool diameter [mm/inch]	400/15.7
Measuring accuracy [gmm]	< 0.5	Max. tool weight [kg/lbs]	30/66
Power usage [kW]	1.5	Order No.	80.240.00

Technical data subject to change without prior notice

Tool Dynamic TD 800: For specialists



Picture shows special equipment: Runout measuring console

**TOOL DYNAMIC TD 800
SPECIAL BALANCING MACHINES**

Your solution for big rotors up to Ø 800 mm

Based on the proven Tool Dynamic balancing technology, the Tool Dynamic TD 800 allows balancing of large rotors of all kinds including bearing rings, grinding wheels and turbine wheels. With hand tailored clamping adapters you can balance your rotors quickly and easily, as usual.



The safety hood is segmented and opens to the side. Thus the rotor is accessible from above. Heavy parts can be handled by a crane.

Technical details			
Tool Dynamic TD 800			
Dimensions l x h x d [mm/inch]	2000 x 1950 x 1020 / 79 x 77 x 42	Compressed air [bar/psi]	5-6/87
Weight [kg/lbs]	600/1323	Air consumption [l/h]	30
Spindle speed [rpm]	100-600	max. tool length [mm/inch]	750/29.5
Measuring accuracy [gmm]	< 0.5	max. tool diameter [mm/inch]	800/31.5
Power requirements [V/Hz]	230/50-60	max. tool weight [kg/lbs]	110/242
Power usage [kW]	1.0	Order No.	80.270.00

Technical data subject to change without prior notice

Tool Dynamic TD Automatic: For professionals



TOOL DYNAMIC TD AUTOMATIC AUTOMATIC BALANCING TECHNOLOGY

We take balancing to the next level: faster, better, more efficient!

The new Tool Dynamic TD Automatic

The new Tool Dynamic TD Automatic is a truly universal CNC-based balancing machine with automated correction of the unbalance. It automatically corrects the unbalance in one or two planes by drilling, milling or grinding. The machine can work vertically and horizontally.

The balancing machine is controlled by an integrated 19" touch-screen. The numerical control is a Siemens 840DSL, which can be accessed simultaneously with the balancing software.

Automatic Balancing – that’s how it works

After measuring the unbalance the software calculates how deep the machine must drill, mill or grind in order to correct the unbalance. The balancing spindle turns to the correct position. The integrated CNC unit moves to the pre-selected balancing plane and automatically removes the appropriate amount of material. Done.

Balancing could not be any faster or easier. Errors, such as those caused by incorrect marking on the tool holder or through inadvertently incorrect drilling depths are no longer an issue.

- Measures and corrects unbalance in one step
- Rapid, easy and economic
- No incorrect drilling on the holder
- Integration into automatic production lines is possible
- Specific software for particular methods of balancing available

Tool Dynamic TD Automatic – automatic vertical CNC based balancing machine: **Maximum comfort, maximum process reliability with highest efficiency and precision.**

Order No. 80.260.00

Improve your efficiency: balancing in record time!

Balancing process:

Simple measuring run,
balance correction and check

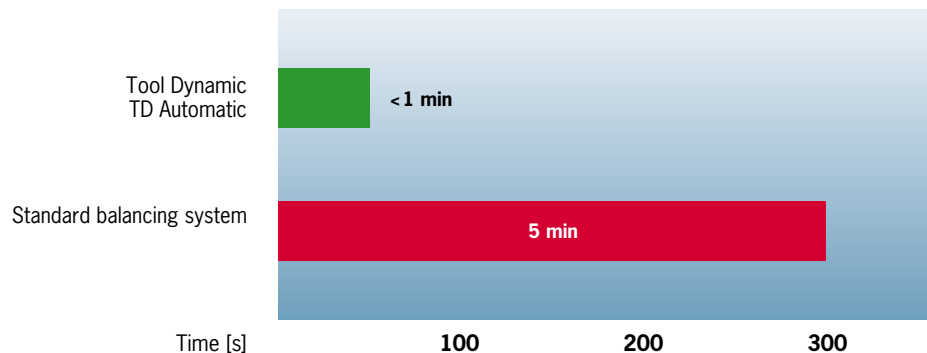

TOOL DYNAMIC TD AUTOMATIC PRODUCT FEATURES

Your benefits at a glance

- Correction of unbalance is fully automated by drilling, milling or grinding in one or two planes with the help of an integrated simultaneous 4 Axis CNC machine tool
- Integrated and exchangeable balancing adapters clamp holders with the highest precision. There are standard adapters for all common interfaces and customized solutions for special purposes
- Gripper for automated indexing (optional). It can be mounted without any additional tools and changed together with the balancing adapter
- Chips are removed by exhaust (suction) equipment
- Central lubrication enables a nearly maintenance free 3 shift use
- Balancing spindle and control box are cooled
- Dynamic measuring mode enables shortest measuring times – balance and control your holders in record time!
- Simple measuring mode: measuring, drilling and checking in less than **1 minute!**
- Integration of robot unit is possible – fully integrate your balancing machine into your production line!
- Intelligent software allows for the fast and efficient re-balancing of holders that have been balanced on the machine once before



Automated correction of unbalance via CNC machining unit

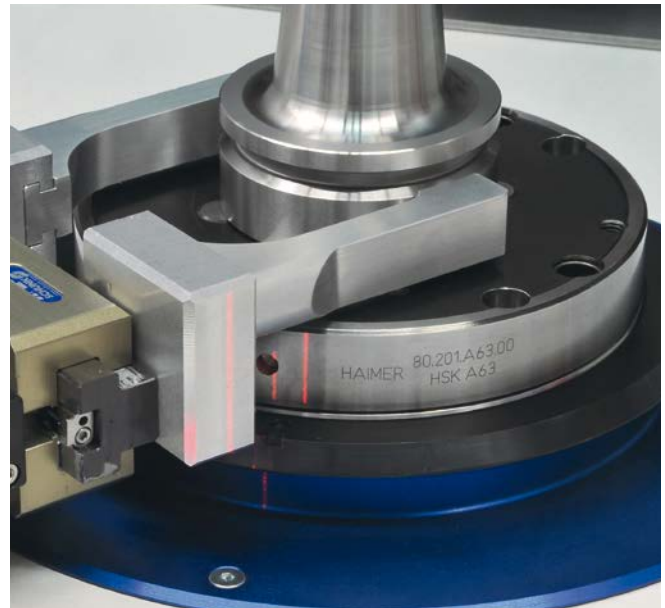

Integrated balancing adapter and gripper for automatic index measuring

TOOL DYNAMIC TD AUTOMATIC PRODUCT FEATURES

Technical data		
Measuring accuracy		
Measuring accuracy	<0.5 gmm	
Limitation of the rotor		
Max. diameter (mm/inch)	400 / 15.74	
Max. length (mm/inch)	600 / 23.6	
Max. weight (kg/lbs)	50 / 110	
Operational range		
X-axis (mm/inch)	155 / 6.10	
Y-axis (mm/inch)	395 / 15.55	
Z-axis (mm/inch)	205 / 8.07	
B-axis	360°	
Rapid mode	20 m/min	on all axis
Balancing spindle		
Max. RPM	1400 U/min/rpm	
Max. torque	35 Nm	
CNC unit		
Interface	VDI 30	
Max. engine speed	6000 U/min	adjustable
Max. torque	15 Nm	at S3-25%
Max. drilling capacity (mm/inch)	∅ 10 mm / 3/8"	in hardened steel with HRC 60
Operational range of rotor in horizontal mode		
Max. diameter (mm/inch)	400 / 15.74	
Max. height (mm/inch)	250 / 9.8	
Operational range of rotor in vertical mode		
Max. diameter (mm/inch)	400 / 15.74	
Max. height (mm/inch)	280 / 11.0	

Technical data subject to change without prior notice



Integrated control and balancing software

APPLICATION EXAMPLES



Compressor wheel for turbocharger
Balancing by peripheral milling axial.

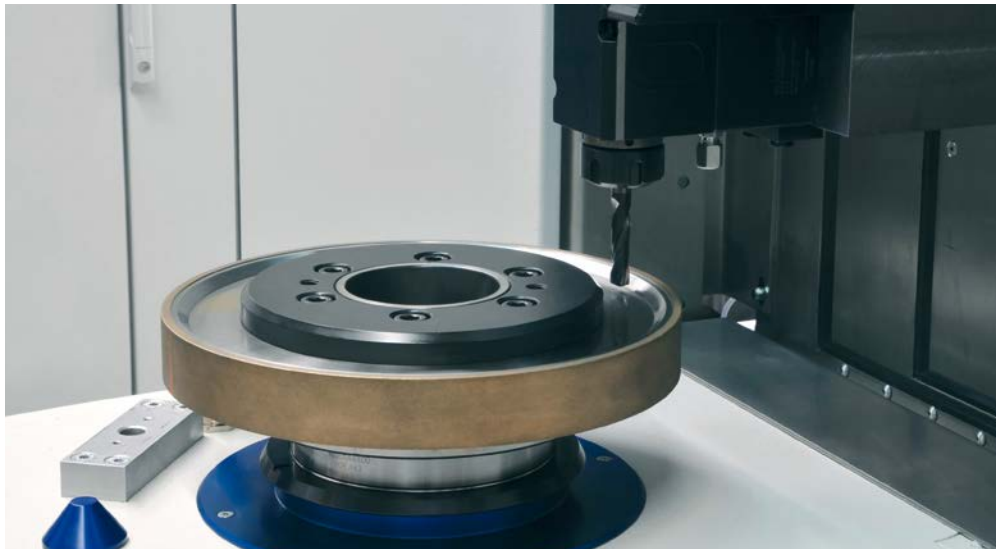

Balancing of grinding wheels by axial drilling
Balanced grinding wheels reduce the surface roughness of the work piece which leads to a remarkable increase of the process performance and to a higher precision of the end product.

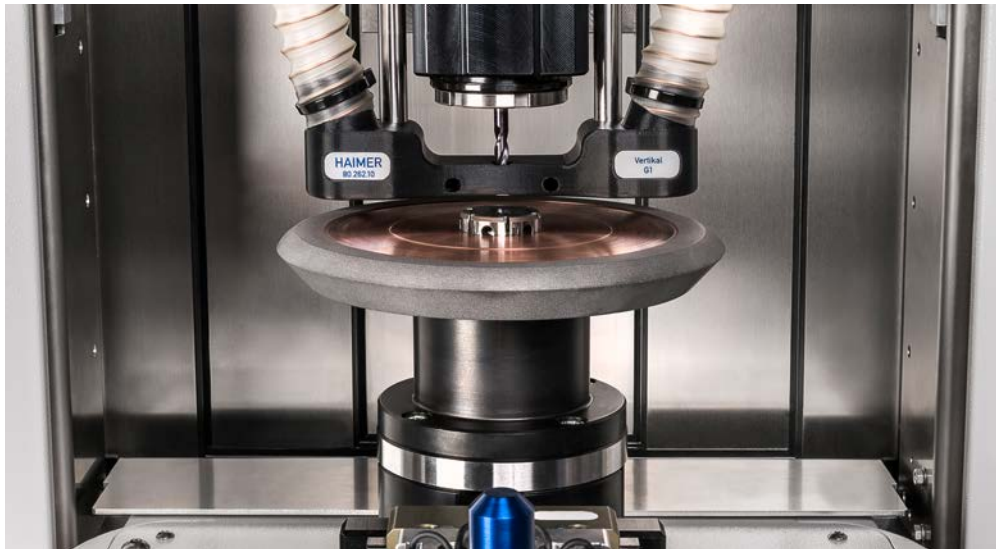

Balancing of grinding wheels by axial drilling



Tools for woodworking

Balancing prevents breakage of the cutting edge and reduces vibrations, enabling the highest accuracy and the cleanest edges on your workpiece. This raises your productivity and allows you to realize a higher cutting capacity.



Balancing of fine boring heads

Get better tolerance grades and better roundness. The cutting capacity can be raised up to 300%.

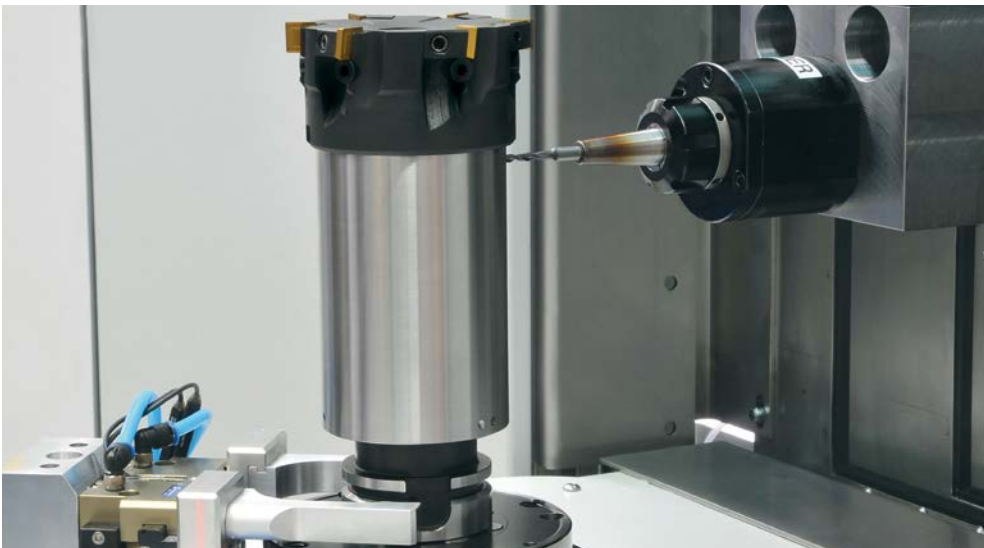

Milling head, balancing in two planes

Long projecting tools must be balanced in two planes in order to eliminate the couple unbalance (dynamic balancing). On longer tools this leads to a higher cutting capacity and a better surface finish.

APPLICATION EXAMPLES



Balancing of tools with a HG balancing adapter for tools with a cylindrical shank
For further information please go to p. 42.

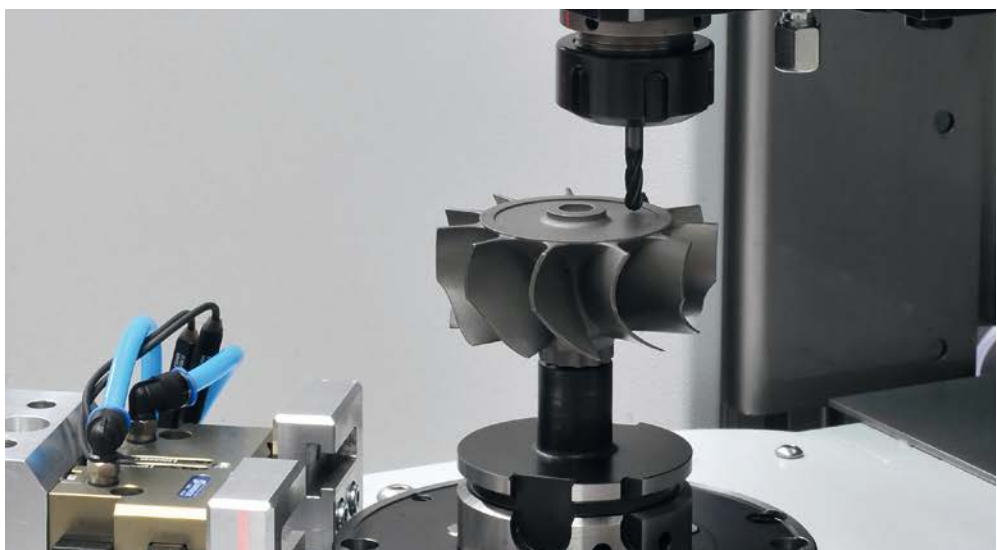

Compressor wheel for turbo charger
Axial drilling.

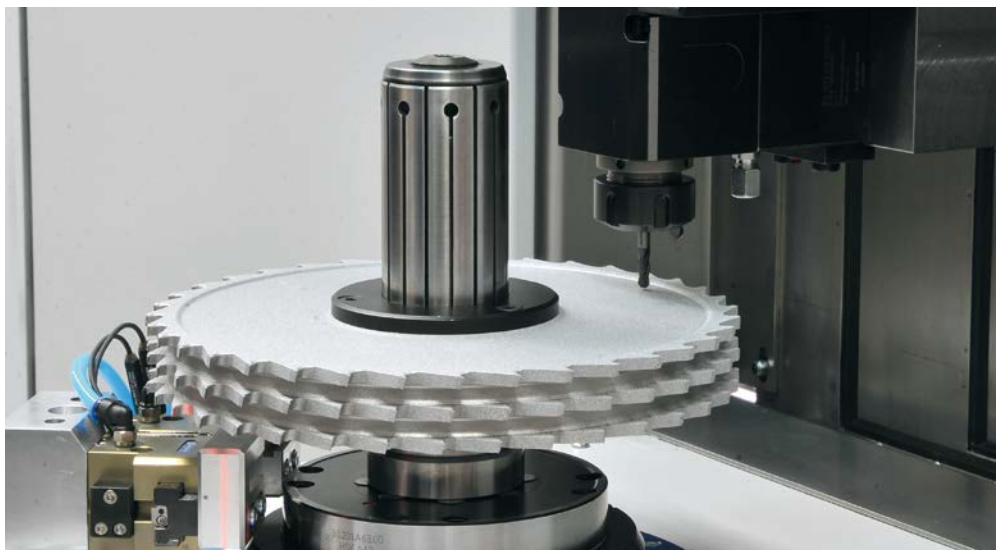

Balancing of PCD jointing cutters for laminate
Balancing enables the best edge quality for the piece of furniture by vibration-free tool run. In addition the noise while machining is reduced to a minimum.

RUNOUT MEASURING DEVICE FOR TD 1002

Accessories for maximum performance!

Runout measuring device



With the runout measuring device you can do an easy and reliable check of your grinding wheel's runout and axial runout. The runout measuring unit consists of: Measuring arm with tripod and fine indicator in 0.001 mm accuracy execution as well as a measuring roll.

Runout measuring device
Order No. 80.254.00

Axial runout check



Measuring runout and axial runout as well as balancing without re-clamping!

Runout measuring

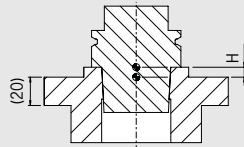

- Micrometer- precise clamping for highest measuring accuracy and repeatability
- Easy and quickest changing due to compact design

Attention: Adapters only to be used with original HAIMER Tool Dynamic Balancing Machines

HSK balancing adapter with automatic clamping system				
HSK interface	Adapter Order No.	Analogy	Description	Height H
HSK 25				
E	80.201.E25.00		Adapter for HSK-E25 with clamping system	0 mm
HSK 32				
A	80.201.A32.00		Adapter for HSK-A32 with clamping system	0 mm
B	80.201.E25.00	B32 = E25	Adapter for HSK-E25 with clamping system	0 mm
C	80.201.A32.00	C32 = A32	Adapter for HSK-A32 with clamping system	0 mm
D	80.201.E25.00	D32 = E25	Adapter for HSK-E25 with clamping system	0 mm
E	80.201.E32.00		Adapter for HSK-E32 with clamping system	0 mm
F	80.201.E25.00	F32 = E25	Adapter for HSK-E25 with clamping system	0 mm
HSK 40				
A	80.201.A40.00		Adapter for HSK-A40 with clamping system	0 mm
B	80.201.E32.00	B40 = E32	Adapter for HSK-E32 with clamping system	0 mm
C	80.201.A40.00	C40 = A40	Adapter for HSK-A40 with clamping system	0 mm
D	80.201.E32.00	D40 = E32	Adapter for HSK-E32 with clamping system	0 mm
E	80.201.E40.00		Adapter for HSK-E40 with clamping system	0 mm
F	80.201.E32.00	F40 = E32	Adapter for HSK-E32 with clamping system	0 mm
HSK 50				
A	80.201.A50.00		Adapter for HSK-A50 with clamping system	0 mm
B	80.201.E40.00	B50 = E40	Adapter for HSK-E40 with clamping system	0 mm
C	80.201.A50.00	C50 = A50	Adapter for HSK-A50 with clamping system	0 mm
D	80.201.E40.00	D50 = E40	Adapter for HSK-E40 with clamping system	0 mm
E	80.201.E50.00		Adapter for HSK-E50 with clamping system	0 mm
F	80.201.E40.00	F50 = E40	Adapter for HSK-E40 with clamping system	0 mm
HSK 63				
A	80.201.A63.00		Adapter for HSK-A63 with clamping system	0 mm
B	80.201.E50.00	B63 = E50	Adapter for HSK-E50 with clamping system	0 mm
C	80.201.A63.00	C63 = A63	Adapter for HSK-A63 with clamping system	0 mm
D	80.201.E50.00	D63 = E50	Adapter for HSK-E50 with clamping system	0 mm
E	80.201.E63.00		Adapter for HSK-E63 with clamping system	0 mm
F	80.201.E50.00	F63 = E50	Adapter for HSK-E50 with clamping system	0 mm
Weinig				
Weinig	80.201.W63.00		Adapter for Weinig tool holder	0 mm
Makino				
Makino	80.201.F63.00.M	Makino F63	Adapter for Makino F63 tool holder	0 mm
Makino	80.201.F80.00.M	Makino F80	Adapter for Makino F80 tool holder	0 mm
HSK 80				
A	80.201.A80.00		Adapter for HSK-A80 with clamping system	0 mm
B	80.201.E63.00	B80 = E63	Adapter for HSK-E63 with clamping system	0 mm
C	80.201.A80.00	C80 = A80	Adapter for HSK-A80 with clamping system	0 mm
D	80.201.E63.00	D80 = E63	Adapter for HSK-E63 with clamping system	0 mm
E	80.201.E80.00		Adapter for HSK-E80 with clamping system	0 mm
F	80.201.E63.00	F80 = E63	Adapter for HSK-E63 with clamping system	0 mm
HSK 100				
A	80.201.A100.00		Adapter for HSK-A100 with clamping system	0 mm
B	80.201.E80.00	B100 = E80	Adapter for HSK-E80 with clamping system	0 mm
C	80.201.A100.00	C100 = A100	Adapter for HSK-A100 with clamping system	0 mm
D	80.201.E80.00	D100 = E80	Adapter for HSK-E80 with clamping system	0 mm
E	80.201.E100.00		Adapter for HSK-E100 with clamping system	0 mm
F	80.201.E80.00	F100 = E80	Adapter for HSK-E80 with clamping system	0 mm
HSK 125				
A	80.201.A125.00		Adapter for HSK-A125 with clamping system	61 mm

Technical data subject to change without prior notice

- Micrometer- precise clamping for highest measuring accuracy and repeatability
- Easy and quickest changing due to compact design

Attention: Adapters only to be used with original HAIMER Tool Dynamic Balancing Machines

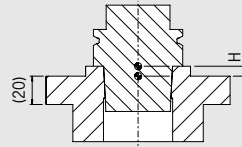

SK/BT/CAT/BBT balancing adapter with automatic clamping system

Order No.	for taper size	for pull stud	Height H
80.201.330.01	SK30/BT30/BBT30 ¹⁾	thread M12	0 mm
80.201.330.01.IN	CAT30	thread 1/2"-13	0 mm
80.201.330.02	SK30	DIN 69872; ISO 7388-3, form AF/AD/AC	0 mm
80.201.330.02	BT30/BBT30 ¹⁾	MAS 30°/45°/90°; ISO 7388-3, form JD/JF	0 mm
80.201.330.04	SK30	ISO 7388-3, form UF/UD/UC	0 mm
80.201.140.01	SK40	DIN 2080 thread M16	0 mm
80.201.340.01	SK40/BT40/BBT40 ¹⁾	thread M16	0 mm
80.201.340.01.IN	CAT40	thread 5/8"-11	0 mm
80.201.340.02	CAT40/SK40	DIN 69872; ISO 7388-3, form AF/AD/AC	0 mm
80.201.340.02	BT40/BBT40 ¹⁾	JIS B6339	0 mm
80.201.340.04	CAT40/SK40	ISO 7388-3, form UF/UD/UC	0 mm
80.201.340.06	BT40	MAS 30°/45°/90°; ISO 7388-3, form JD/JF	0 mm
80.201.150.01	SK50	DIN 2080 thread M24	0 mm
80.201.350.01	SK50/BT50/BBT50 ¹⁾	thread M24	0 mm
80.201.350.01.IN	CAT50	thread 1"-8	0 mm
80.201.350.02	CAT50/SK50	DIN 69872; ISO 7388-3, form AF/AD/AC	0 mm
80.201.350.02	BT50/BBT50 ¹⁾	JIS B6339	0 mm
80.201.350.04	CAT50/SK50	ISO 7388-3, form UF/UD/UC	0 mm
80.201.350.06	BT50/BBT50 ¹⁾	MAS 30°/45°/90°; ISO 7388-3, form JD/ JF	0 mm

Balancing adapter Capto with automatic clamping system

Order No.	for taper size	Height H
80.201.C3.00	Capto C3	7 mm
80.201.C4.00	Capto C4	7 mm
80.201.C5.00	Capto C5	7 mm
80.201.C6.00	Capto C6	7 mm
80.201.C8.00	Capto C8	7 mm
80.201.C10.00	Capto C10	7 mm

Balancing adapter KM with automatic clamping system

Order No.	for taper size	Height H
80.201.KM40.01	KM40	7 mm
80.201.KM50.01	KM50	7 mm
80.201.KM63.01	KM63	7 mm
80.201.KM80.01	KM80	7 mm
80.201.KM100.01	KM100	30 mm
80.201.KM125.00	KM125 (upon request)	

Balancing adapter KM4X with automatic clamping system

Order No.	for taper size	Height H
80.201.KM63.4X	KM4X 63	7 mm
80.201.KM100.4X	KM4X 100	30 mm

¹⁾ BBT: also suitable for BIG-Plus
Further adapters available on request

Technical data subject to change without prior notice

HSA BALANCING ADAPTER (AUTOMATIC)

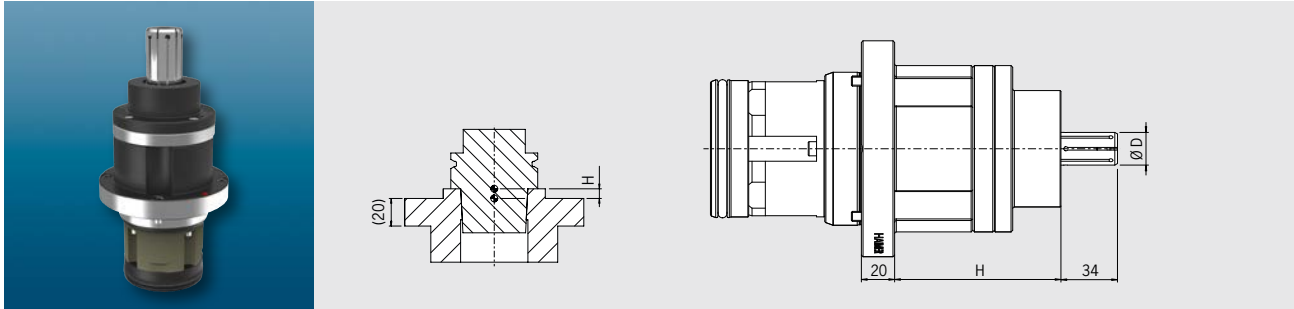

Balancing adapter with automatic clamping for internal diameters of 15 mm up to 100 mm.

- Clamping range - 0.3 / + 0.5 mm
- Precise center clamping for highest repeatability
- Fine balanced to < 1 gmm
- Can be used individually

Note:

Adapters only to be used with original HAIMER Tool Dynamic Balancing Machines

HSA balancing adapter with automatic clamping system 80.201.HSA00.00

HSA 00 Clamping range 15-20 mm

Order No.	Clamping set	Bore $\varnothing D - 0.3 / + 0.5$ mm	Height H	Clamping length
80.201.HSZ00.15		$\varnothing 15.0$	100 mm	34 mm
80.201.HSZ00.15.5		$\varnothing 15.5$	100 mm	34 mm
80.201.HSZ00.16		$\varnothing 16.0$	100 mm	34 mm
80.201.HSZ00.16.5		$\varnothing 16.5$	100 mm	34 mm
80.201.HSZ00.17		$\varnothing 17.0$	100 mm	34 mm
80.201.HSZ00.17.5		$\varnothing 17.5$	100 mm	34 mm
80.201.HSZ00.18		$\varnothing 18.0$	100 mm	34 mm
80.201.HSZ00.18.5		$\varnothing 18.5$	100 mm	34 mm
80.201.HSZ00.19		$\varnothing 19.0$	100 mm	34 mm
80.201.HSZ00.19.5		$\varnothing 19.5$	100 mm	34 mm
80.201.HSZ00.20		$\varnothing 20.0$	100 mm	34 mm



HSA Balancing Adapters (automatic) are also available with diameters of 20 mm – 100 mm

Technical data subject to change without prior notice

HSM BALANCING ADAPTER (MANUAL)

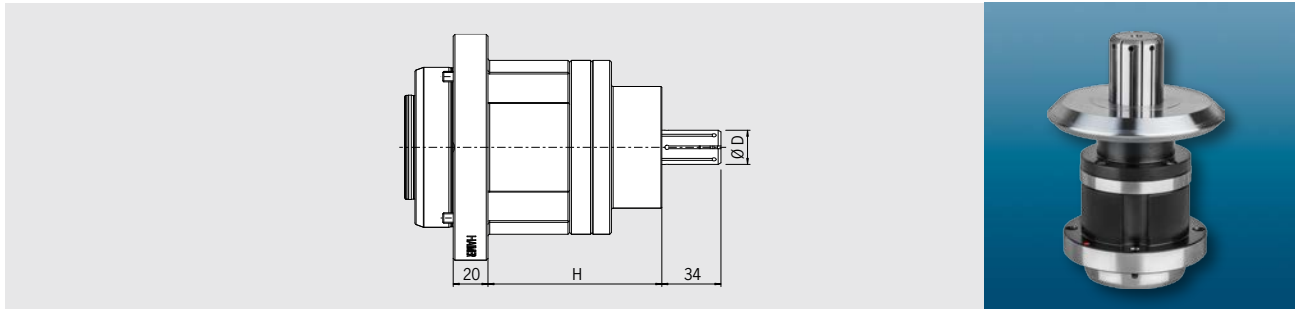

Balancing adapter with manual clamping for internal diameters of 15 mm up to 100 mm

- Clamping range - 0.3 / + 0.5 mm
- Precise center clamping for highest repeatability
- Fine balanced to < 1 gmm
- Can be used individually

Note:

Adapters only to be used with original HAIMER Tool Dynamic Balancing Machines

HSM balancing adapter with manual clamping system 80.201.HSM00.00				
HSM 00 Clamping range 15-20 mm				
Order No.	Clamping set	Bore Ø D - 0.3 /+ 0.5 mm	Height H	Clamping length
80.201.HSZ00.15		Ø 15.0	100 mm	34 mm
80.201.HSZ00.15.5		Ø 15.5	100 mm	34 mm
80.201.HSZ00.16		Ø 16.0	100 mm	34 mm
80.201.HSZ00.16.5		Ø 16.5	100 mm	34 mm
80.201.HSZ00.17		Ø 17.0	100 mm	34 mm
80.201.HSZ00.17.5		Ø 17.5	100 mm	34 mm
80.201.HSZ00.18		Ø 18.0	100 mm	34 mm
80.201.HSZ00.18.5		Ø 18.5	100 mm	34 mm
80.201.HSZ00.19		Ø 19.0	100 mm	34 mm
80.201.HSZ00.19.5		Ø 19.5	100 mm	34 mm
80.201.HSZ00.20		Ø 20.0	100 mm	34 mm

HSM Balancing Adapters (manual) are also available with diameters of 20 mm – 100 mm



Please specify collet with balance adapter order

Technical data subject to change without prior notice

HG BALANCING ADAPTER

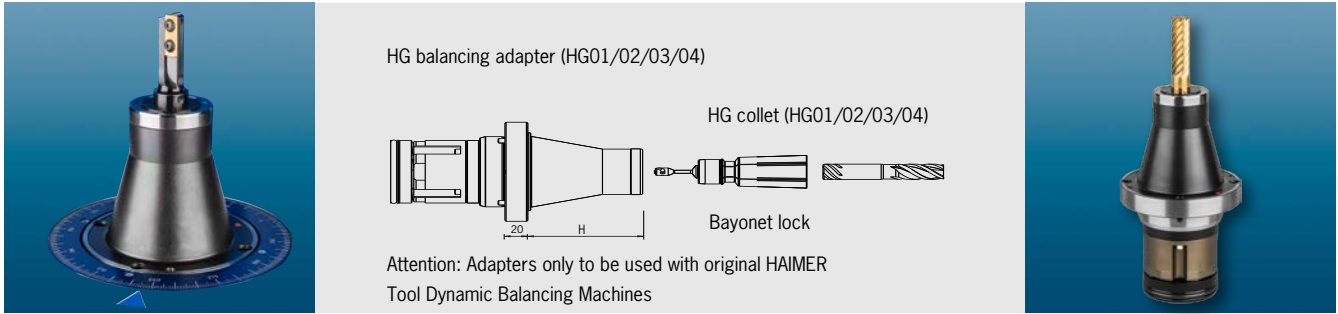

Balancing adapter for tools with a cylindrical shank

- For efficient and automatic clamping of tools with a cylindrical shank
- For cylindrical shanks up to tolerance h8
- Available with shank diameter up to 40 mm upon request

Balancing adapter with exchangeable high precision collets (system HG) and automatic clamping. From now on you can clamp your cylindrical shank tools directly in the balancing adapter without any accessories.

HG adapter Order No.	Collet Order No.	Clamping range	Height H
HG01	HG01	Ø 2–9.25 mm	
80.201.HG01.00	80.201.HG01.02	2 mm	80 mm
	80.201.HG01.02.5	2.5 mm	80 mm
	80.201.HG01.03	3 mm	80 mm
	80.201.HG01.03.5	3.5 mm	80 mm
	80.201.HG01.1/8Z	1/8"	80 mm
	80.201.HG01.04	4 mm	80 mm
	80.201.HG01.04.5	4.5 mm	80 mm
	80.201.HG01.3/16Z	3/16"	80 mm
	80.201.HG01.05	5 mm	80 mm
	80.201.HG01.05.5	5.5 mm	80 mm
	80.201.HG01.05.6	5.6 mm	80 mm
	80.201.HG01.06	6 mm	80 mm
	80.201.HG01.06.3	6.3 mm	80 mm
	80.201.HG01.1/4Z	1/4"	80 mm
	80.201.HG01.07	7 mm	80 mm
	80.201.HG01.07.1	7.1 mm	80 mm
	80.201.HG01.5/16Z	5/16" mm	80 mm
	80.201.HG01.08	8 mm	80 mm
	80.201.HG01.09	9 mm	80 mm
	80.201.HG01.09.25	9.25 mm	80 mm
HG02	HG02	Ø 10–14 mm	
80.201.HG02.00	80.201.HG02.3/8Z	3/8"	80 mm
	80.201.HG02.10	10 mm	80 mm
	80.201.HG02.11	11 mm	80 mm
	80.201.HG02.7/16Z	7/16"	80 mm
	80.201.HG02.12	12 mm	80 mm
	80.201.HG02.12.5	12.5 mm	80 mm
	80.201.HG02.1/2Z	1/2"	80 mm
	80.201.HG02.13	13 mm	80 mm
	80.201.HG02.14	14 mm	80 mm
	80.201.HG02.9/16Z	9/16"	80 mm

HG adapter Order No.	Collet Order No.	Clamping range	Height H
HG03	HG03	Ø 16–20 mm	
80.201.HG03.00	80.201.HG03.5/8Z	5/8"	80 mm
	80.201.HG03.16	16 mm	80 mm
	80.201.HG03.18	18 mm	80 mm
	80.201.HG03.3/4Z	3/4"	80 mm
	80.201.HG03.20	20 mm	80 mm
HG04	HG04	Ø 20–32 mm	
80.201.HG04.00	80.201.HG04.20	20 mm	100 mm
	80.201.HG04.22	22 mm	100 mm
	80.201.HG04.25	25 mm	100 mm
	80.201.HG04.27	27 mm	100 mm
	80.201.HG04.30	30 mm	100 mm
	80.201.HG04.32	32 mm	100 mm

Technical data subject to change without prior notice

BALANCING RINGS SET OF BALANCING SCREWS

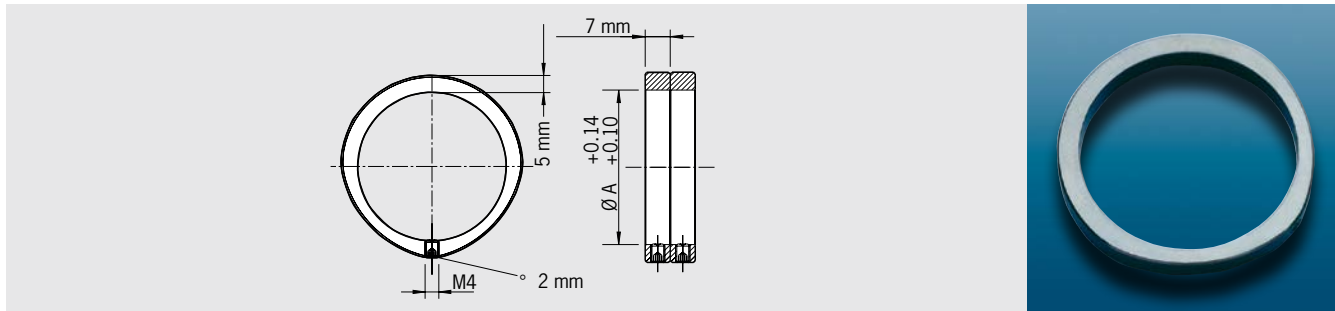

For fine-balancing of all tool holders with cylindrical outer diameters (diam. A)
The balancing rings have a defined unbalance in themselves. They are turned in such a position that the unbalance of the tool holder will be corrected. There are always 2 rings needed per balancing plane.

- Included in delivery: 2 balancing rings with clamping screws without hex wrench

Order No.	Ø A mm	approx. unbalance
79.350.15	15	9 g·mm
79.350.17	17	12 g·mm
79.350.19	19	16 g·mm
79.350.20	20	17 g·mm
79.350.22	22	20 g·mm
79.350.24	24	27 g·mm
79.350.25	25	32 g·mm
79.350.26	26	33 g·mm
79.350.27	27	33 g·mm
79.350.28	28	40 g·mm
79.350.30	30	45 g·mm
79.350.32	32	36 g·mm
79.350.34	34	40 g·mm
79.350.35	35	48 g·mm
79.350.36	36	47 g·mm
79.350.38	38	53 g·mm
79.350.40	40	57 g·mm
79.350.42	42	65 g·mm

Order No.	Ø A mm	approx. unbalance
79.350.43	43	65 g·mm
79.350.44	44	68 g·mm
79.350.46	46	75 g·mm
79.350.48	48	81 g·mm
79.350.50	50	87 g·mm
79.350.52	52	94 g·mm
79.350.53	53	86 g·mm
79.350.54	54	91 g·mm
79.350.55	55	94 g·mm
79.350.56	56	100 g·mm
79.350.58	58	106 g·mm
79.350.60	60	110 g·mm
79.350.62	62	120 g·mm
79.350.63	63	123 g·mm
79.350.64	64	126 g·mm
79.350.65	65	129 g·mm
79.350.66	66	120 g·mm
79.350.68	68	135 g·mm

Order No.	Ø A mm	approx. unbalance
79.350.70	70	145 g·mm
79.350.72	72	152 g·mm
79.350.74	74	160 g·mm
79.350.76	76	168 g·mm
79.350.78	78	178 g·mm
79.350.80	80	186 g·mm
79.350.82	82	199 g·mm
79.350.84	84	215 g·mm
79.350.86	86	224 g·mm
79.350.87	87	225 g·mm
79.350.88	88	226 g·mm
79.350.89	89	231 g·mm
79.350.90	90	237 g·mm
79.350.92	92	247 g·mm
79.350.94	94	253 g·mm
79.350.96	96	267 g·mm
79.350.98	98	277 g·mm
79.350.100	100	285 g·mm

Set of Balancing Screws

For fine balancing of shrink fit chucks
(Thread integrated in the shrink fit chucks).

- Balancing quickly and precisely
- No damage of tool holders
- Can be repeated as often as necessary
- Suitable for tool holders of all brands
- The balancing machine calculates the necessary weight of the screws (e.g. HAIMER TOOL DYNAMIC)

Included in delivery: case with 11 x 10 pcs.
balancing screws M6, 1 screw driver



Accessories

Set of Balancing Screws

Order No.

80.203.00

Technical data subject to change without prior notice

BALANCING ARBOR

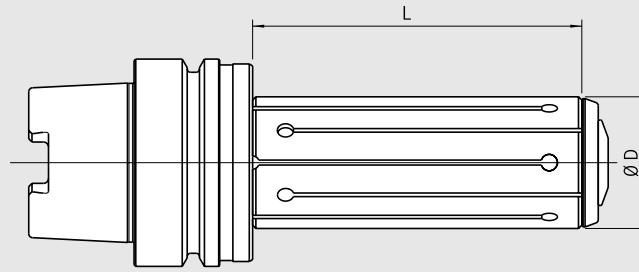

- To balance tools with cylindrical bore
- Precise center clamping for highest repeatability

- Fine balanced to < 1 gmm
- Can be used individually

Balancing arbour	Collet	Clamping range Ø D	L
Order No.	Order No.		
DG07, Clamping range 25–34.5 mm			
80.250.A63.070	80.250.07.25	Ø 25–25.5 mm	100 mm
	80.250.07.26	Ø 26–26.5 mm	100 mm
	80.250.07.28	Ø 28–28.5 mm	100 mm
	80.250.07.30	Ø 30–30.5 mm	100 mm
	80.250.07.32	Ø 32–32.5 mm	100 mm
	80.250.07.34	Ø 34–34.5 mm	100 mm
DG08, Clamping range 35–44.5 mm			
80.250.A63.080	80.250.08.35	Ø 35–35.5 mm	100 mm
	80.250.08.36	Ø 36–36.5 mm	100 mm
	80.250.08.38	Ø 38–38.5 mm	100 mm
	80.250.08.40	Ø 40–40.5 mm	100 mm
	80.250.08.42	Ø 42–42.5 mm	100 mm
	80.250.08.44	Ø 44–44.5 mm	100 mm
DG09, Clamping range 45–54.5 mm			
80.250.A63.090	80.250.09.45	Ø 45–45.5 mm	125 mm
	80.250.09.48	Ø 48–48.5 mm	125 mm
	80.250.09.50	Ø 50–50.5 mm	125 mm
	80.250.09.52	Ø 52–52.5 mm	125 mm
	80.250.09.54	Ø 54–54.5 mm	125 mm
DG10, Clamping range 55–65.5 mm			
80.250.A63.100	80.250.10.55	Ø 55–55.5 mm	135 mm
	80.250.10.58	Ø 58–58.5 mm	135 mm
	80.250.10.60	Ø 60–60.5 mm	135 mm
	80.250.10.62	Ø 62–62.5 mm	135 mm
	80.250.10.64	Ø 64–64.5 mm	135 mm
	80.250.10.65	Ø 65–65.5 mm	135 mm

Please specify collet with balancing arbor order

Technical data subject to change without prior notice

TOOL MANAGEMENT



HAIMER Tool Management: For efficient working

The HAIMER Tool Management completes the HAIMER product program as a system provider around tool clamping. That means HAIMER offers the complete Tool Management equipment from a single source. As a complete solution for tool presetting and tool management, HAIMER Tool Management provides you with a functional and ergonomic design for your work station. The storage, setup and management of

tools is simplified and optimized by HAIMER solutions so that efficient working is guaranteed.

- Modular room design according to the customer's needs
- Shrinking, balancing and presetting already integrated into the concept
- Tidy and isolated solution for confined workspaces

See our catalog "HAIMER Tool Management" for further information.

TOOL MANAGEMENT

This is how you store your grinding wheel adapters and accessories correctly.



THE MORE HAIMER, THE BETTER.



Passion for precision

HAIMER is a German, medium-sized family business. We develop and produce innovative ultra-precision products, primarily in the field of tool clamping. As the market leader in Germany, the continuous technological innovations of our products is very important to us and for this reason we annually invest 8–10% in research and development. With this budget, we can afford our own product development team, which constantly works on practical innovations and continual product improvements. 14 sales and service subsidiaries guarantee the first class HAIMER service and specific customer orientated product consultation worldwide on the spot. However, all products are solely produced in Igenhausen, Germany. In accordance with our corporate philosophy: **Quality Wins.**

Our new North American Headquarters

Located in the Chicago suburb of Villa Park, HAIMER's new 25,000 ft² headquarters is designed and built to help facilitate the company's growth in the North American marketplace. It features state-of-the-art training facilities able to accommodate up to sixty people. The expanded showroom includes a CNC machining center for demo cuts, shrink fit and balancing machines under power, and HAIMER's complete range of tool holding solutions on display. Both the training facilities and showroom are wired with HD cameras for live and web-based presentations.

From our new facility, HAIMER will also provide balance inspection, precision balancing and data chipping services for tool holders from HAIMER or any other manufacturer. Future service offerings will include end mill regrinding as well as Safe-Lock™ groove modifications.



HAIMER USA – Chicago, Illinois

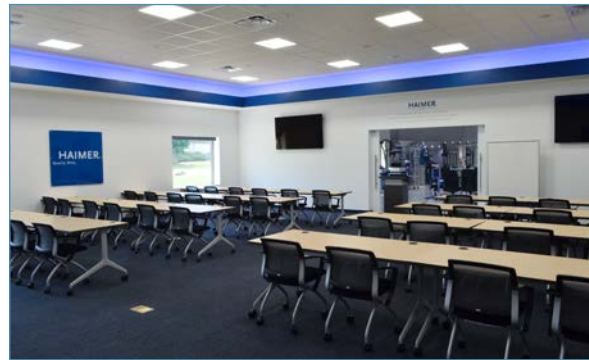

HAIMER USA's Competency Center features a 60-seat Training Room



HAIMER's 25,000 ft² North American Headquarters includes a spacious customer lounge

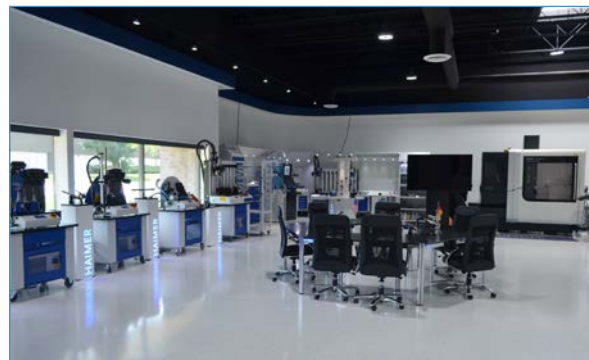

HAIMER USA's new Showroom is equipped with the latest cutting edge technologies

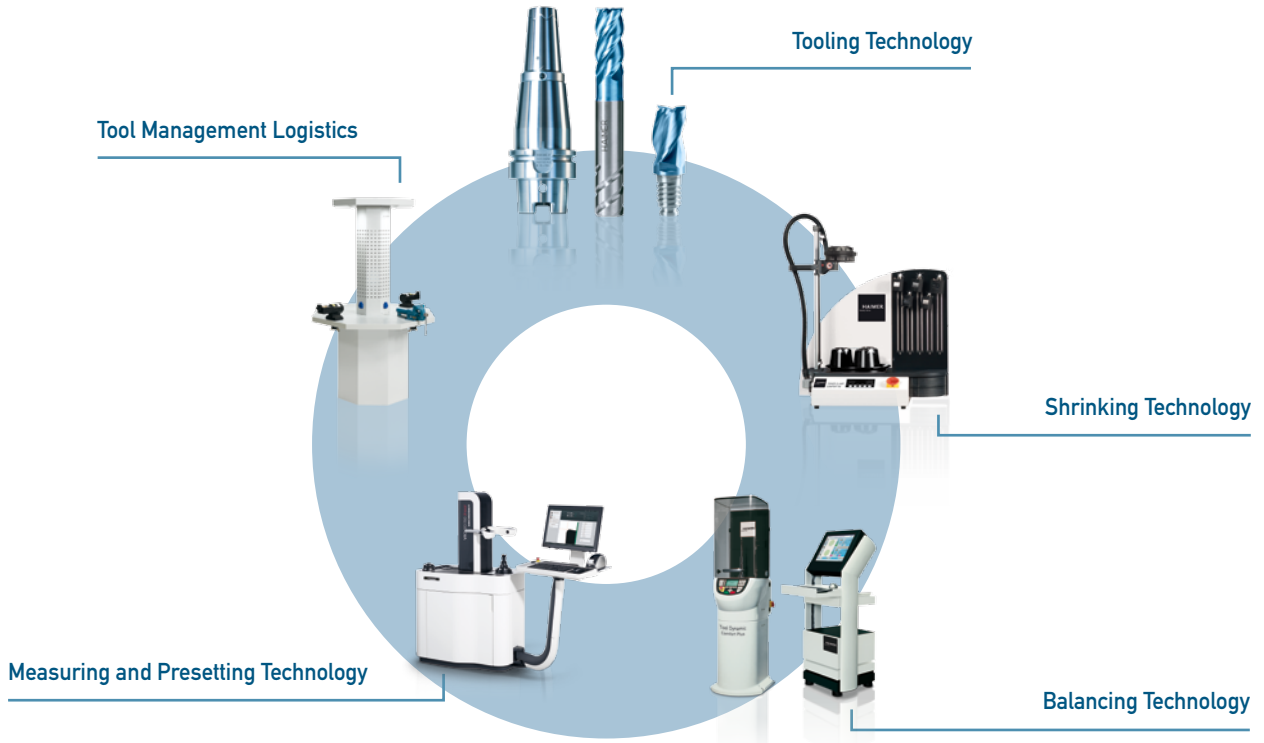

Haimer USA, LLC | 134 E. Hill Street | Villa Park, IL 60181 | USA

Phone 1-866-837-3265 | Fax (630) 833-1507 | Mail: haimer@haimer-usa.com | www.haimer-usa.com

Haimer Mexico | Anillo Vial Fray Junipero Serra No. 16950 Bodega 2 | Micro Parque Industrial Sotavento

Querétaro., QRO. C.P 76127 | Mexico | Phone +442-243-0950 | www.haimer-mexico.com | haimer@haimermx.com