

GUHRING

The Tool Company

Expanded Diameter Range

For extreme process reliability

From hole diameter 11 to 40.0 mm (0.433 - 1.575 in.)

For drilling depths 1.5xD, 3xD, 5xD, 7xD and 10xD

With interchangeable inserts for steel, stainless steel, cast iron and Al

Holder/interchangeable inserts for pilot drilling/countersinking



HT 800 WP The interchangeable insert drilling system



Now get the EXACT diameter you need!

Reduce your insert diameter by up to 0.20mm

Guhring can grind down HT 800 WP inserts by as much as 0.20mm in diameter to allow you an even more extensive range of sizes.

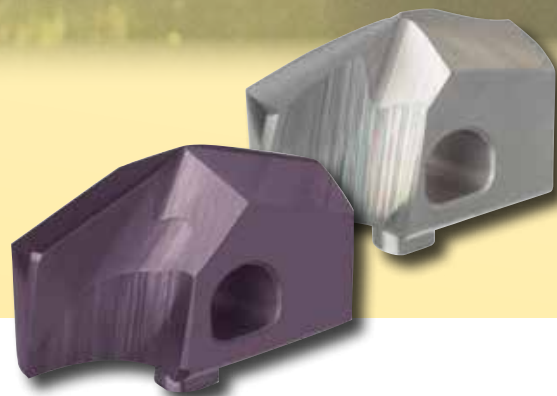

HT 800 WP Insert modification

Can't find the exact drill size you're looking for? Problem solved!

Guhring now has the capability to modify our standard HT 800 replaceable tip drill inserts by grinding the diameters down by as much as .20mm (.0079") and recoating them with their original PVD coating. This service is provided through our manufacturing facility in Brookfield, WI.

The HT 800 drill bodies recommended for each insert size have sufficient clearance to accommodate for the maximum allowable insert diameter reduction, so there is no need to modify the body. Our comprehensive selection of drill body lengths – 1xD, 1.5xD, 3xD, 5xD, 7xD, and 10xD – paired with the flexibility of modifying the insert diameters provides a vast array of replaceable tip drill options.

Contact Guhring's Reconditioning division for details at (800) 776-6170.

INSERTS

• Technical features	Page	6
• Application recommendations	Page	6
• Notes regarding application	Page	6
• Standard offering	Page	8

INSERT HOLDERS

• Technical features	Page	7
• Selected machining results	Page	7
• Standard offering	Page	14

ACCESSORIES

• Spare parts	Page	21
---------------	------	----

TECHNICAL

• up to drilling depth 1 x D	Page	32
• up to drilling depth 1.5 x D	Page	34
• up to drilling depth 3 x D	Page	36
• up to drilling depth 5 x D	Page	38
• up to drilling depth 7 x D	Page	40
• up to drilling depth 10 x D	Page	42

TROUBLESHOOTING

Page	27
------	----

With the new HT 800WP interchangeable drilling system Guhring provides high-performance and cost-efficient holders for holes in diameters 11.00 to 40.0 mm (0.433 - 1.575 in.) These drills excel thanks to the following advantages:

A Extended tool life

Thanks to special, micro-machined cutting edges and the application oriented surface finish the interchangeable inserts of the HT 800 WP drilling system are especially wear resistant.

The holders of the HT 800 WP drilling system also possess a very high wear resistance. This is based on the optimized holder material with nickel plated surface as well as incremental holder sizes in steps of 0.5 mm up to diameter 31.99 mm and in steps of 1.0 mm above diameter 32.00 mm. This leads to less wear on the holder body.

B Optimized chip flow

Thanks to their flute cross section the holders of the HT 800 WP drilling system ensure optimal chip evacuation from the hole even with larger drilling depths.

C Perfect cooling lubrication

A perfect cooling lubrication is ensured by coolant ducts with maximum cross section, exiting in the flute. This enables an optimal cooling lubrication of the cutting edges and additionally supports chip evacuation from the hole.

D Highly accurate and rigid insert seat

The accurate insert seat enables the insert change in the machine in only a few, simple steps with a standard Torx screw driver. Thanks to the optimized material for the holders of the HT 800 WP drilling system, the insert can be changed more frequently than with conventional systems before the holder needs to be replaced due to wear of the insert seat. The clamping screws with screw lock ensure a secure holding of the interchangeable insert in the holder even with machines subject to high levels of vibrations.

Rigid holders

The close stepped diameter jumps with the holder sizes do more than simply reducing wear. Through the better guidance of the tool in the hole they also increase the rigidity of the HT 800 WP drilling system. Subsequently, resulting in longer tool life as well as improved workpiece surfaces.

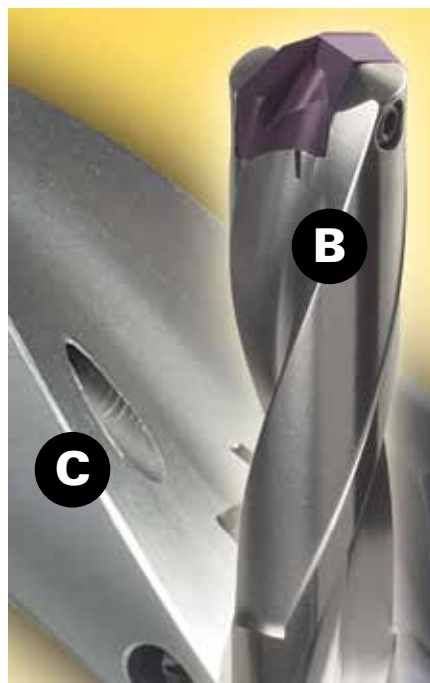

HT 800 WP - Application Tips

Please observe the following notes and recommendations for the application of Guhring's HT 800 WP tools:

We recommend replacing the clamping screw when changing the insert.

Therefore, every holder is supplied with a clamping screw, Guhring no. 4071, and screwdriver, Guhring no. 1612. Every interchangeable insert is also supplied with a clamping screw, Guhring no. 4071.

When changing the insert please observe the following tightening torques for the clamping screw. Adhering to them is absolutely necessary for optimal machining results!

Diameter range (mm)	11.0 - 12.99	13.0 - 13.99	14.0 - 15.99	16.0 - 17.99	18.0 - 19.99	20.0 - 21.99	22.0 - 25.99	30.0 - 40.00
Thread	M2.2	M2.5	M3	M3.5	M4	M4.5	M5	M6
Torx size	T7	T8	T9	T10	T15	T15	T20	T25
Tightening torque [Nm]	0.80	1.00	1.70	2.70	4.00	6.0	8.00	14.0

Details apply to thread locking (Loctite)!

Examples of the HT800 WP extended tool life





Guhring no.	4107 + 4112	4109 + 4112	4109 + 4112	4107 + 4113	4108 + 4113
Diameter	17.5	17.5	17.5	17.5	14.1
Coating	nanoFIREX®	nanoFIREX®	nanoFIREX®	FIREX®	FIREX®
Material group	alloyed heat-treatable steel	alloyed heat-treatable steel	general structural steels	cast iron	cast iron
Material description	42CrMo4/1.7275	42CrMo4/1.7275	St52-3/1.0570	GG25/0.6025	GGG40/0.7040
Drill. depth [mm]	50	122.5	122.5	50	70
Hole type	blind hole	blind hole	blind hole	blind hole	blind hole
Cooling	IC 40 bar	IC 40 bar	IC 40 bar	IC 40 bar	IC 55 bar
Coolant	soluble oil	soluble oil	soluble oil	soluble oil	soluble oil
Machine type	machining center	machining center	machining center	machining center	machining center
v_c [m/min]	100	85	130	80	160
f_z [mm]	0.28	0.25	0.15	0.30	0.60
Tool life [m]	50	30	35	250	120



HT 800 WP Interchangeable Inserts

HT 800 WP interchangeable inserts are a synergy of tool material, geometry and coating perfectly adapted to your specific range of application. Subsequently, you will always achieve optimal machining results with maximum performance and highest economic efficiency. The insert change with HT 800 WP can be performed in the machine problem-free, the interchangeable insert always sits perfectly clamped and positioned in the holder.

Technical features and application recommendations

		Guhring no.	4112	4115	4113	4114	4111
Tool material			solid carbide	solid carbide	solid carbide	solid carbide	solid carbide
Surface			nanoFIREX®	nanoA	FIREX®	bright	nanoA
Point geometry			2-facet	relieved cone	2-facet	relieved cone	2-facet
Point angle			140°	140°	140°	140°	145°
Tolerance			h7	h7	m7	h7	m7
Diameter			11.0 - 40.0	11.0 - 40.0	11.0 - 40.0	11.0 - 40.0	11.0 - 40.0
Application			steel	stainl. steel	cast iron	aluminium	pilot drilling
							
Application group	Material examples						
P	steel, cast steel, stainless steel (ferritic and martensitic)		●	○	○		○
M	stainless steel and cast steel (austenitic and austenitic/ferritic)		○	●			○
K	grey cast iron, spheroidal graphite and malleable cast iron		○		●		○
N	aluminium and other non-ferrous metals					●	○
S	Special, Super- and Ti-alloys			○			○
H	Hardened steels and chilled cast iron			○			○



● optimal suitability

○ limited suitability

Complete compatibility

The new interchangeable inserts as well as the new holders of the HT 800 WP system are fully compatible with the conventional HT 800 WP interchangeable inserts and holders. You can, therefore, apply the new interchangeable inserts in the already existing HT 800 WP holders or combine new holders with existing interchangeable inserts. Drilling tests with both combination possibilities have shown that the efficiency of each package lies above the values of the old HT 800 WP system. You will definitely benefit!

The pilot insert 4111 can be combined with any holder, if the application requires a 145° point angle.

		Guhring no.	7645	7632	7635
Tool material			solid carbide	solid carbide	solid carbide
Surface			TiN	TiAlN	bright
Type			CPGT ... R	CPGW ...	CPGT ... R
Application			steel	cast iron	aluminium
					
Application group	Material examples				
P	steel, cast steel, stainless steel (ferritic and martensitic)		●	○	
M	stainless steel and cast steel (austenitic and austenitic/ferritic)		○		
K	grey cast iron, spheroidal graphite and malleable cast iron		○	●	
N	aluminium and other non-ferrous metals				●
S	Special, Super- and Ti-alloys		○		
H	Hardened steels and chilled cast iron		○		

● optimal suitability

○ limited suitability

HT 800 WP Interchangeable Insert Holders

HT 800 WP holders offer highest accuracy and rigidity. The open flute together with internal cooling guarantees an optimal chip evacuation particularly from deeper holes. The reinforced shank to DIN 6535 HE ensures the strong and accurate clamping of the holder in the tool holder. As it meets the DIN standard for solid carbide monoblock tools, a problem-free changeover to the HT 800 WP system in production is possible at any time.

Guhring no.	4105	4106	4107	4108	4109	4110
Drilling depth	1 x D	1.5 x D	3 x D	5 x D	7 x D	10 x D
Diameter	11.0 - 40.00	11.0 - 40.00	11.0 - 40.00	11.0 - 40.00	11.0 - 31.99	11.0 - 31.99
Shank	DIN 6535-HE	DIN 6535-HE	DIN 6535-HE	DIN 6535-HE	DIN 6535-HE	DIN 6535-HE
Page #	14	15 - 17	15 - 17	15 - 17	18 - 20	18 - 20
45° pilot drilling/ countersinking						

Special tools

In addition to our HT 800 WP standard tools we also supply HT 800 WP stepped tools as well as alternative coatings for HT 800 WP interchangeable inserts as special solutions. Special sizes are available on request.



Carbide inserts with material-specific attributes

Four distinct geometries are available with the HT 800 WP drilling system, and they are completely interchangeable with any style drill body. The unique locating post and set screw design assures quick and accurate tool changes. The high performance insert designs allow for maximum penetration rates that far exceed conventional spade drills or dual insert drill designs.

① Choose your diameter (metric or inch)

② Choose the appropriate insert for your workpiece material

③ Note the holder size for that insert diameter; select a holder (1.5xD to 10xD) from the holder pages.

①					②				③	
Dia	Dia	h	b	l4	Series 4115 nano-A	Series 4114 bright	Series 4113 FIREX®	Series 4112 nano-FIREX®	Drill Holder Size	Pilot Drill Holder Size
fract.	mm	mm	mm	mm	EDP No.	EDP No.	EDP No.	EDP No.		
	11.00 11.20	7.5	4.5	2.1	9041150110000 9041150112000	9041140110000 9041140112000	9041130110000 9041130112000	9041120110000 9041120112000	110	110
29/64	11.50 11.51 11.70 11.80	7.5	4.5	2.1 2.1 2.1 2.1	9041150115000 9041150115100 9041150117000 9041150118000	9041140115000 9041140115100 9041140117000 9041140118000	9041130115000 9041130115100 9041130117000 9041130118000	9041120115000 9041120115100 9041120117000 9041120118000	115	110
15/32	11.91			2.2	9041150119100	9041140119100	9041130119100	9041120119100		
31/64	12.00 12.10 12.20 12.30	7.7	5.0	2.2 2.2 2.2 2.2	9041150120000 9041150121000 9041150122000 9041150123000	9041140120000 9041140121000 9041140122000 9041140123000	9041130120000 9041130121000 9041130122000 9041130123000	9041120120000 9041120121000 9041120122000 9041120123000	120	120
1/2	12.50 12.60 12.70 12.80 12.90	7.7	5.0	2.3 2.3 2.3 2.3 2.3	9041150125000 9041150126000 9041150127000 9041150128000 9041150129000	9041140125000 9041140126000 9041140127000 9041140128000 9041140129000	9041130125000 9041130126000 9041130127000 9041130128000 9041130129000	9041120125000 9041120126000 9041120127000 9041120128000 9041120129000	125	120
33/64	13.00 13.10	8.5	5.5	2.4 2.4	9041150130000 9041150131000	9041140130000 9041140131000	9041130130000 9041130131000	9041120130000 9041120131000	130	130
17/32	13.49			2.4	9041150134900	9041140134900	9041130134900	9041120134900		
35/64	13.50 13.60 13.70 13.80 13.89	8.5	5.5	2.4 2.4 2.4 2.5 2.5	9041150135000 9041150136000 9041150137000 9041150138000 9041150138900	9041140135000 9041140136000 9041140137000 9041140138000 9041140138900	9041130135000 9041130136000 9041130137000 9041130138000 9041130138900	9041120135000 9041120136000 9041120137000 9041120138000 9041120138900	135	130
9/16	14.00 14.10 14.29 14.40	9.6	6.0	2.5 2.5 2.6 2.6	9041150140000 9041150141000 9041150142900 9041150144000	9041140140000 9041140141000 9041140142900 9041140144000	9041130140000 9041130141000 9041130142900 9041130144000	9041120140000 9041120141000 9041120142900 9041120144000	140	140
37/64	14.50 14.60 14.68 14.70 14.80	9.6	6.0	2.6 2.7 2.7 2.7 2.7	9041150145000 9041150146000 9041150146800 9041150147000 9041150148000	9041140145000 9041140146000 9041140146800 9041140147000 9041140148000	9041130145000 9041130146000 9041130146800 9041130147000 9041130148000	9041120145000 9041120146000 9041120146800 9041120147000 9041120148000	145	140
19/32	15.00 15.08 15.10 15.20	9.8	6.0	2.7 2.7 2.7 2.8	9041150150000 9041150150800 9041150151000 9041150152000	9041140150000 9041140150800 9041140151000 9041140152000	9041130150000 9041130150800 9041130151000 9041130152000	9041120150000 9041120150800 9041120151000 9041120152000	150	140
39/64	15.30 15.48			2.8 2.8	9041150153000 9041150154800	9041140153000 9041140154800	9041130153000 9041130154800	9041120153000 9041120154800		
5/8	15.50 15.60 15.70 15.80 15.87	9.8	6.0	2.8 2.9 2.9 2.9 2.9	9041150155000 9041150156000 9041150157000 9041150158000 9041150158700	9041140155000 9041140156000 9041140157000 9041140158000 9041140158700	9041130155000 9041130156000 9041130157000 9041130158000 9041130158700	9041120155000 9041120156000 9041120157000 9041120158000 9041120158700	155	140
41/64	16.00 16.27	11.0	7.0	2.9 3.0	9041150160000 9041150162700	9041140160000 9041140162700	9041130160000 9041130162700	9041120160000 9041120162700	160	160

Inserts are supplied with clamping screw, Guhring no. 4071.

HT 800 WP Interchangeable Inserts For Machining Stainless Steel

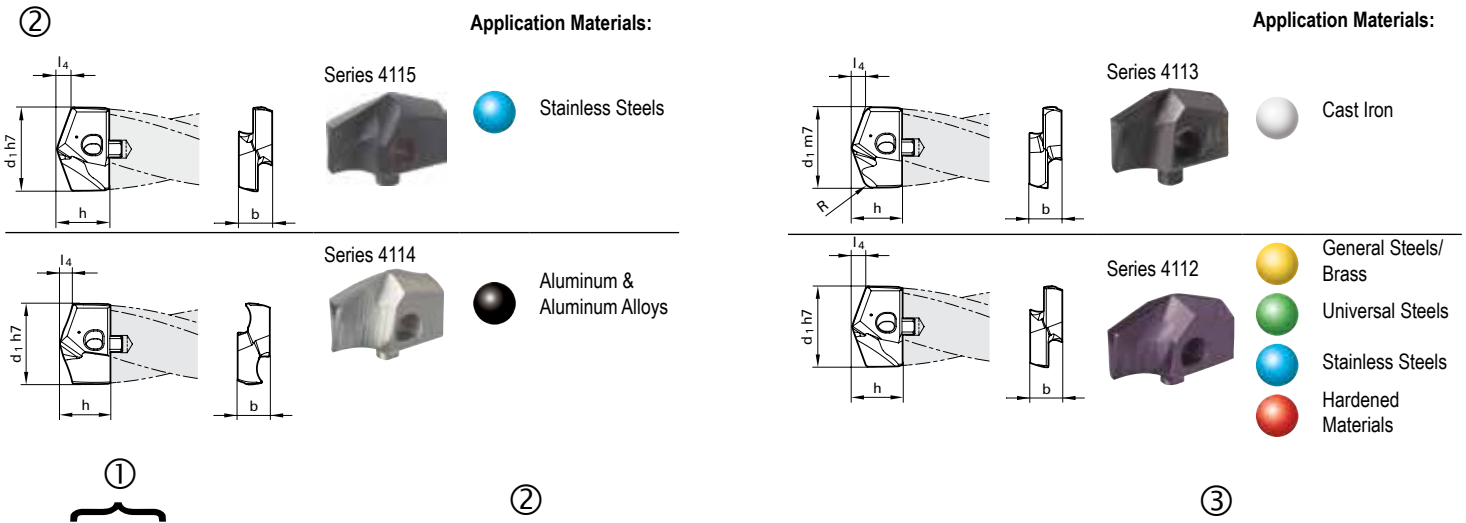

Dia		h	b	l ₄	Series 4111 nano-A	Series 4114 bright	Series 4113 FIREX®	Series 4112 nano-FIREX®	Drill Holder Size	Pilot Drill Holder Size
fract.	mm	mm	mm	mm	EDP No.	EDP No.	EDP No.	EDP No.		
21/32	16.50	11.0	7.0	3.0	9041150165000	9041140165000	9041130165000	9041120165000	165	160
	16.67			3.0	9041150166700	9041140166700	9041130166700	9041120166700		
43/64	17.00	11.0	7.0	3.1	9041150170000	9041140170000	9041130170000	9041120170000	170	160
	17.07			3.1	9041150170700	9041140170700	9041130170700	9041120170700		
	17.46			3.1	9041150174600	9041140174600	9041130174600	9041120174600		
45/64	17.50	11.0	7.0	3.2	9041150175000	9041140175000	9041130175000	9041120175000	175	160
	17.60			3.2	9041150176000	9041140176000	9041130176000	9041120176000		
	17.86			3.3	9041150178600	9041140178600	9041130178600	9041120178600		
23/32	18.00	12.6	8.0	3.3	9041150180000	9041140180000	9041130180000	9041120180000	180	180
	18.26			3.3	9041150182600	9041140182600	9041130182600	9041120182600		
47/64	18.50	12.6	8.0	3.4	9041150185000	9041140185000	9041130185000	9041120185000	185	180
	18.65			3.4	9041150186500	9041140186500	9041130186500	9041120186500		
3/4	19.00	12.6	8.0	3.5	9041150190000	9041140190000	9041130190000	9041120190000	190	180
	19.05			3.5	9041150190500	9041140190500	9041130190500	9041120190500		
	19.45			3.5	9041150194500	9041140194500	9041130194500	9041120194500		
25/32	19.50	12.6	8.0	3.6	9041150195000	9041140195000	9041130195000	9041120195000	195	180
	19.60			3.6	9041150196000	9041140196000	9041130196000	9041120196000		
	19.84			3.6	9041150198400	9041140198400	9041130198400	9041120198400		
51/64	20.00	13.9	9.0	3.6	9041150200000	9041140200000	9041130200000	9041120200000	200	200
	20.24			3.6	9041150202400	9041140202400	9041130202400	9041120202400		
13/16	20.50	13.9	9.0	3.7	9041150205000	9041140205000	9041130205000	9041120205000	205	200
	20.64			3.8	9041150206400	9041140206400	9041130206400	9041120206400		
53/64	21.00	13.9	9.0	3.8	9041150210000	9041140210000	9041130210000	9041120210000	210	200
	21.03			3.8	9041150210300	9041140210300	9041130210300	9041120210300		
	21.10			3.9	9041150211000	9041140211000	9041130211000	9041120211000		
	21.43			3.9	9041150214300	9041140214300	9041130214300	9041120214300		
55/64	21.50	13.9	9.0	3.9	9041150215000	9041140215000	9041130215000	9041120215000	215	200
	21.83			4.0	9041150218300	9041140218300	9041130218300	9041120218300		
7/8	22.00	15.3	10.0	4.0	9041150220000	9041140220000	9041130220000	9041120220000	220	220
	22.22			4.0	9041150222200	9041140222200	9041130222200	9041120222200		
57/64	22.50	15.3	10.0	4.1	9041150225000	9041140225000	9041130225000	9041120225000	225	220
	22.62			4.1	9041150226200	9041140226200	9041130226200	9041120226200		
29/32	23.00	15.3	10.0	4.2	9041150230000	9041140230000	9041130230000	9041120230000	230	220
	23.02			4.2	9041150230200	9041140230200	9041130230200	9041120230200		
	23.42			4.3	9041150234200	9041140234200	9041130234200	9041120234200		
15/16	23.50	15.3	10.0	4.3	9041150235000	9041140235000	9041130235000	9041120235000	235	220
	23.81			4.3	9041150238100	9041140238100	9041130238100	9041120238100		
61/64	24.00	15.8	11.0	4.4	9041150240000	9041140240000	9041130240000	9041120240000	240	240
	24.10			4.4	9041150241000	9041140241000	9041130241000	9041120241000		
	24.21			4.4	9041150242100	9041140242100	9041130242100	9041120242100		
31/32	24.50	15.8	11.0	4.5	9041150245000	9041140245000	9041130245000	9041120245000	245	240
	24.61			4.5	9041150246100	9041140246100	9041130246100	9041120246100		
1	25.00	15.8	11.0	4.5	9041150250000	9041140250000	9041130250000	9041120250000	250	240
	25.40			4.6	9041150254000	9041140254000	9041130254000	9041120254000		
	25.50			4.6	9041150255000	9041140255000	9041130255000	9041120255000		

Inserts are supplied with clamping screw, Guhring no. 4071.

Carbide inserts with material-specific attributes

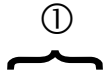

Dia fract.	Dia mm	h mm	b mm	l _d mm	Series 4115 nano-A	Series 4114 bright	Series 4113 FIREX®	Series 4112 nano-FIREX®	Drill Holder Size	Pilot Drill Holder Size
					EDP No.	EDP No.	EDP No.	EDP No.		
1 1/32	26.00	20.00	12.00	4.80	9041150260000	9041140260000	9041130260000	9041120260000	260	260
	26.19	20.00	12.00	4.80	9041150261900	9041140261900	9041130261900	9041120261900		
1 3/64	26.50	20.00	12.00	4.90	9041150265000	9041140265000	9041130265000	9041120265000	265	260
	26.59	20.00	12.00	4.90	9041150265900	9041140265900	9041130265900	9041120265900		
1 3/32	27.00	20.00	12.00	5.00	9041150270000	9041140270000	9041130270000	9041120270000	270	260
	27.50	20.00	12.00	5.10	9041150275000	9041140275000	9041130275000	9041120275000		
	27.70	20.00	12.00	5.10	9041150277000	9041140277000	9041130277000	9041120277000		
	27.78	20.00	12.00	5.10	9041150277800	9041140277800	9041130277800	9041120277800		
1 7/64	28.00	20.70	13.00	5.10	9041150280000	9041140280000	9041130280000	9041120280000	280	280
	28.18	20.70	13.00	5.20	9041150281800	9041140281800	9041130281800	9041120281800		
1 1/8	28.50	20.70	13.00	5.20	9041150285000	9041140285000	9041130285000	9041120285000	285	280
	28.58	20.70	13.00	5.30	9041150285800	9041140285800	9041130285800	9041120285800		
1 5/32	29.00	20.70	13.00	5.30	9041150290000	9041140290000	9041130290000	9041120290000	290	280
	29.37	20.70	13.00	5.40	9041150293700	9041140293700	9041130293700	9041120293700		
1 11/64	29.50	20.70	13.00	5.40	9041150295000	9041140295000	9041130295000	9041120295000	295	280
	29.60	20.70	13.00	5.50	9041150296000			9041120296000		
	29.77	20.70	13.00	5.50	9041150297700	9041140297700	9041130297700	9041120297700		
1 3/16	30.00	22.30	14.00	5.50	9041150300000	9041140300000	9041130300000	9041120300000	300	300
	30.16	22.30	14.00	5.60	9041150301600	9041140301600	9041130301600	9041120301600		
1 7/32	30.50	22.30	14.00	5.70	9041150305000	9041140305000	9041130305000	9041120305000	305	300
	30.96	22.30	14.00	5.70	9041150309600	9041140309600	9041130309600	9041120309600		
1 1/4	31.00	22.30	14.00	5.80	9041150310000	9041140310000	9041130310000	9041120310000	310	300
	31.50	22.30	14.00	5.80	9041150315000	9041140315000	9041130315000	9041120315000		
	31.75	22.30	14.00	5.90	9041150317500	9041140317500	9041130317500	9041120317500		
	32.00	23.10	15.00	6.00	9041150320000	9041140320000	9041130320000	9041120320000		
1 9/32	32.50	23.10	15.00	6.00	9041150325000	9041140325000	9041130325000	9041120325000	320	320
	32.54	23.10	15.00	6.00	9041150325400	9041140325400	9041130325400	9041120325400		
1 19/64	32.94	23.10	15.00	6.10	9041150329400	9041140329400	9041130329400	9041120329400		
1 5/16	33.00	23.10	15.00	6.10	9041150330000	9041140330000	9041130330000	9041120330000	330	320
	33.34	23.10	15.00	6.10	9041150333400	9041140333400	9041130333400	9041120333400		
	33.50	23.10	15.00	6.20	9041150335000	9041140335000	9041130335000	9041120335000		
1 11/32	34.00	23.10	15.00	6.30	9041150340000	9041140340000	9041130340000	9041120340000	340	320
	34.13	23.10	15.00	6.30	9041150341300	9041140341300	9041130341300	9041120341300		
1 3/8	34.50	23.10	15.00	6.40	9041150345000	9041140345000	9041130345000	9041120345000	340	320
	34.93	23.10	15.00	6.40	9041150349300	9041140349300	9041130349300	9041120349300		
1 13/32	35.00	23.10	15.00	6.50	9041150350000	9041140350000	9041130350000	9041120350000	350	320
	35.50	23.10	15.00	6.60	9041150355000	9041140355000	9041130355000	9041120355000		
	35.72	23.10	15.00	6.60	9041150357200	9041140357200	9041130357200	9041120357200		
1 7/16	36.00	23.90	16.00	6.70	9041150360000	9041140360000	9041130360000	9041120360000	360	360
	36.50	23.90	16.00	6.70	9041150365000	9041140365000	9041130365000	9041120365000		
	36.51	23.90	16.00	6.80	9041150365100	9041140365100	9041130365100	9041120365100		
1 15/32	37.00	23.90	16.00	6.80	9041150370000	9041140370000	9041130370000	9041120370000	370	360
	37.31	23.90	16.00	6.90	9041150373100	9041140373100	9041130373100	9041120373100		
	37.50	23.90	16.00	7.00	9041150375000	9041140375000	9041130375000	9041120375000		
1 1/2	38.00	23.90	16.00	7.00	9041150380000	9041140380000	9041130380000	9041120380000	380	360
	38.10	23.90	16.00	7.00	9041150381000	9041140381000	9041130381000	9041120381000		
1 33/64	38.50	23.90	16.00	7.10	9041150385000	9041140385000	9041130385000	9041120385000		
1 3/4	39.00	23.90	16.00	7.10	9041150390000	9041140390000	9041130390000	9041120390000	390	360
	39.50	23.90	16.00	7.20	9041150395000	9041140395000	9041130395000	9041120395000		
	40.00	23.90	16.00	7.30	9041150400000	9041140400000	9041130400000	9041120400000		

Inserts are supplied with clamping screw, Guhring no. 4071.

HT 800 WP Interchangeable Insert Drills

Drill inserts for pilot drilling - Series 4111

Carbide, nano-A™ coated

145° point angle, m7 tolerance on diameter

The Series 4105 is a pilot and chamfering tool specifically designed for pilot drilling 7xD and especially 10xD deep hole applications. The Series 4111 insert has a 145° point angle which is required for proper application of a pre-drill pilot operation. This pilot drilling insert is also interchangeable with all other HT 800 WP body series.

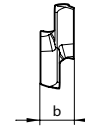
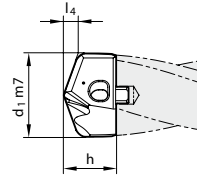

Series 4111



②

③

Dia fract.	Dia mm	h mm	b mm	l4 mm	Series 4111 nano-A insert	Drill Holder Size	Pilot Drill Holder Size
					EDP No.		
	11.00	6.9	4.5	1.5	9041110110000	110	110
	11.20	6.9	4.5	1.5	9041110112000		
29/64	11.50	6.9	4.5	1.5	9041110115000	115	110
	11.51	6.9	4.5	1.5	9041110115100		
	11.70	6.9	4.5	1.6	9041110117000		
15/32	11.80	6.9	4.5	1.6	9041110118000	120	120
	11.91	6.9	4.5	1.6	9041110119100		
31/64	12.00	7.1	5.0	1.6	9041110120000	125	120
	12.10	7.1	5.0	1.6	9041110121000		
	12.20	7.1	5.0	1.6	9041110122000		
	12.30	7.1	5.0	1.6	9041110123000		
1/2	12.50	7.1	5.0	1.7	9041110125000	130	130
	12.60	7.1	5.0	1.7	9041110126000		
	12.70	7.1	5.0	1.7	9041110127000		
	12.80	7.1	5.0	1.7	9041110128000		
	12.90	7.1	5.0	1.7	9041110129000		
33/64	13.00	7.9	5.5	1.7	9041110130000	135	130
	13.10	7.9	5.5	1.7	9041110131000		
	13.49	7.9	5.5	1.8	9041110134900		
35/64	13.50	7.9	5.5	1.8	9041110135000	140	140
	13.60	7.9	5.5	1.8	9041110136000		
	13.70	7.9	5.5	1.8	9041110137000		
	13.80	7.9	5.5	1.9	9041110138000		
	13.89	7.9	5.5	1.9	9041110138900		
	14.00	9.1	6.0	1.9	9041110140000		
9/16	14.10	9.1	6.0	1.9	9041110141000	145	140
	14.29	9.1	6.0	1.9	9041110142900		
	14.40	9.1	6.0	1.9	9041110144000		
	14.50	9.1	6.0	1.9	9041110145000		
37/64	14.60	9.1	6.0	2.0	9041110146000	150	140
	14.68	9.1	6.0	2.0	9041110146800		
	14.70	9.1	6.0	2.0	9041110147000		
	14.80	9.1	6.0	2.0	9041110148000		
	15.00	9.1	6.0	2.0	9041110150000		
19/32	15.08	9.1	6.0	2.0	9041110150800	155	140
	15.10	9.1	6.0	2.0	9041110151000		
	15.20	9.1	6.0	2.0	9041110152000		
	15.30	9.1	6.0	2.1	9041110153000		
	15.48	9.1	6.0	2.1	9041110154800		
	15.50	9.1	6.0	2.1	9041110155000		
	15.60	9.1	6.0	2.1	9041110156000		
5/8	15.70	9.1	6.0	2.1	9041110157000	160	160
	15.80	9.1	6.0	2.1	9041110158000		
	15.87	9.1	6.0	2.1	9041110158700		
	16.00	10.2	7.0	2.1	9041110160000		
	16.27	10.2	7.0	2.2	9041110162700		
41/64	16.50	10.2	7.0	2.2	9041110165000	165	160
	16.67	10.2	7.0	2.2	9041110166700		

Dia fract.	Dia mm	h mm	b mm	l4 mm	Series 4111 nano-A insert	Drill Holder Size	Pilot Drill Holder Size
					EDP No.		
43/64	17.00	10.2	7.0	2.3	9041110170000	170	160
	17.07	10.2	7.0	2.3	9041110170700		
	17.46	10.2	7.0	2.3	9041110174600		
45/64	17.50	10.2	7.0	2.3	9041110175000	175	160
	17.60	10.2	7.0	2.3	9041110176000		
	17.86	10.2	7.0	2.4	9041110178600		
23/32	18.00	11.7	8.0	2.4	9041110180000	180	180
	18.26	11.7	8.0	2.4	9041110182600		
47/64	18.50	11.7	8.0	2.5	9041110185000	185	180
	18.65	11.7	8.0	2.5	9041110186500		
	19.00	11.7	8.0	2.5	9041110190000		
3/4	19.05	11.7	8.0	2.5	9041110190500	190	180
	19.45	11.7	8.0	2.6	9041110194500		
25/32	19.50	11.7	8.0	2.6	9041110195000	195	180
	19.60	11.7	8.0	2.6	9041110196000		
	19.84	11.7	8.0	2.7	9041110198400		
	20.00	12.9	9.0	2.7	9041110200000		
	20.24	12.9	9.0	2.7	9041110202400		
51/64	20.50	12.9	9.0	2.7	9041110205000	200	200
	20.64	12.9	9.0	2.8	9041110206400		
	21.00	12.9	9.0	2.8	9041110210000		
53/64	21.03	12.9	9.0	2.8	9041110210300	210	200
	21.10	12.9	9.0	2.8	9041110211000		
	21.43	12.9	9.0	2.9	9041110214300		
55/64	21.50	13.9	9.0	3.0	9041110215000	215	200
	21.83	13.9	9.0	4.0	9041110218300		
7/8	22.00	14.3	10.0	3.0	9041110220000	220	220
	22.22	14.3	10.0	3.0	9041110222200		
57/64	22.50	14.3	10.0	3.0	9041110225000	225	220
	22.62	14.3	10.0	3.0	9041110226200		
29/32	23.00	14.3	10.0	3.1	9041110230000	230	220
	23.02	14.3	10.0	3.1	9041110230200		
	23.42	14.3	10.0	3.1	9041110234200		
15/16	23.50	14.3	10.0	3.1	9041110235000	235	220
	23.81	14.3	10.0	3.2	9041110238100		
61/64	24.00	14.7	11.0	3.2	9041110240000	240	240
	24.10	14.7	11.0	3.2	9041110241000		
	24.21	14.7	11.0	3.2	9041110242100		
	24.50	14.7	11.0	3.3	9041110245000		
31/32	24.61	14.7	11.0	3.3	9041110246100	245	240
	25.00	14.7	11.0	3.4	9041110250000		
1	25.40	14.7	11.0	3.4	9041110254000	250	240
	25.50	14.7	11.0	3.4	9041110255000		
1 1/32	26.00	19.40	12.00	4.10	9041110260000	260	260
	26.19	19.40	12.00	4.10	9041110261900		
1 3/64	26.50	19.40	12.00	4.10	9041110265000	265	260
	26.59	19.40	12.00	4.20	9041110265900		
	27.00	19.40	12.00	4.20	9041110270000		

Inserts are supplied with clamping screw, Guhring no. 4071.

HT 800 WP Interchangeable Insert Drills

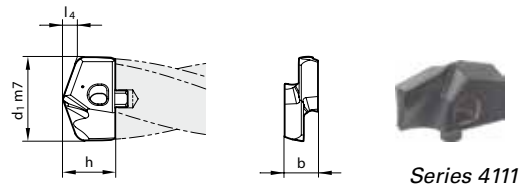

Dia fract.	Dia mm	h mm	b mm	l4 mm	Series 4111 nano-A insert	Drill Holder Size	Pilot Drill Holder Size
					EDP No.		
1 3/32	27.50	19.40	12.00	4.30	9041110275000	275	260
	27.70	19.40	12.00	4.30	9041110277000		
	27.78	19.40	12.00	4.30	9041110277800		
	28.00	20.10	13.00	4.40	9041110280000	280	280
	28.18	20.10	13.00	4.40	9041110281800		
	28.50	20.10	13.00	4.50	9041110285000		
1 5/32	28.58	20.10	13.00	4.50	9041110285800	285	280
	29.00	20.10	13.00	4.60	9041110290000		
	29.37	20.10	13.00	4.60	9041110293700		
1 11/64	29.50	20.10	13.00	4.60	9041110295000	295	280
	29.77	20.10	13.00	4.60	9041110297700		
	30.00	21.70	14.00	4.70	9041110300000		
1 3/16	30.16	21.70	14.00	4.70	9041110301600	300	300
	30.50	21.70	14.00	4.80	9041110305000		
	30.96	21.70	14.00	4.80	9041110309600		
	31.00	21.70	14.00	4.90	9041110310000	310	300
	31.50	21.70	14.00	4.90	9041110315000		
	31.75	21.70	14.00	4.90	9041110317500		
1 1/4	32.00	22.40	15.00	5.00	9041110320000	320	320
	32.50	22.40	15.00	5.10	9041110325000		
	32.54	22.40	15.00	5.10	9041110325400		
1 9/32	32.94	22.40	15.00	5.10	9041110329400	320	320
	33.00	22.40	15.00	5.20	9041110330000		
	33.34	22.40	15.00	5.20	9041110333400		
1 5/16	33.50	22.40	15.00	5.30	9041110335000	330	320
	34.00	22.40	15.00	5.40	9041110340000		
	34.13	22.40	15.00	5.40	9041110341300		
1 11/32	34.50	22.40	15.00	5.40	9041110345000	340	320
	34.93	22.40	15.00	5.40	9041110349300		
	35.00	22.40	15.00	5.50	9041110350000		
	35.50	22.40	15.00	5.60	9041110355000	350	320
	35.72	22.40	15.00	5.60	9041110357200		
	36.00	23.20	16.00	5.70	9041110360000		
	36.50	23.20	16.00	5.70	9041110365000	360	360
	36.51	23.20	16.00	5.70	9041110365100		
	37.00	23.20	16.00	5.80	9041110370000		
1 15/32	37.31	23.20	16.00	5.80	9041110373100	370	360
	37.50	23.20	16.00	5.90	9041110375000		
	38.00	23.20	16.00	6.00	9041110380000		
1 1/2	38.10	23.20	16.00	6.00	9041110381000	380	360
	38.50	23.20	16.00	6.10	9041110385000		
	39.00	23.20	16.00	6.20	9041110390000		
1 33/64	39.50	23.20	16.00	6.20	9041110395000	390	360
	40.00	23.20	16.00	6.20	9041110400000		

Inserts are supplied with clamping screw, Guhring no. 4071.

Countersink inserts for pilot and countersink holes



Series 7645 for steels



Series 7632 for cast iron



Series 7635 for aluminum

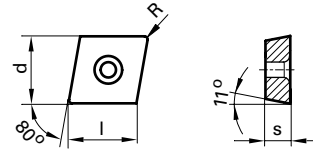

Type	d mm	s mm	R mm	l mm	Series 7645	Series 7632	Series 7635	Drill Holder Size
					TiN coated EDP No.	TiAlN coated EDP No.	Bright finish EDP No.	
CPGT050204R	5.56	2.38	0.4	5.64	9076450520400		9076350520400	110-140
CPGT060204R	6.35	2.38	0.4	6.45	9076450620400		9076350620400	160-280
CPGT09T308R	9.53	3.97	0.8	9.67	9076450930800		9076350930800	300-360
CPGW050204	5.56	2.38	0.4	5.60		9076320520400		110-140
CPGW060204	6.35	2.38	0.4	6.40		9076320620400		160-280
CPGT09T308	9.53	3.97	0.8	9.67		9076320930800		300-360

Slashing Cycle Time:

Guhring HT 800 WP replaceable tip drill vs. a competitor's 2-insert drill

Material: Low alloy steel 1008
 Hole diameter: 1.220"
 Hole depth: 4.00"
 # of holes to produce: 6,000
 Machine tool: Vertical CNC Mill
 Objective: Reduce cycle time

Results:	HT 800 drill	2-insert drill
Spindle Speed	2,050 RPM	935 RPM
Feed rate (IPM)	36.77	11.24
Cycle Time	9.6 seconds	24.6 seconds
Cost per Hole	\$0.28	\$0.51
SAVINGS:	44.65%	

Surface Footage

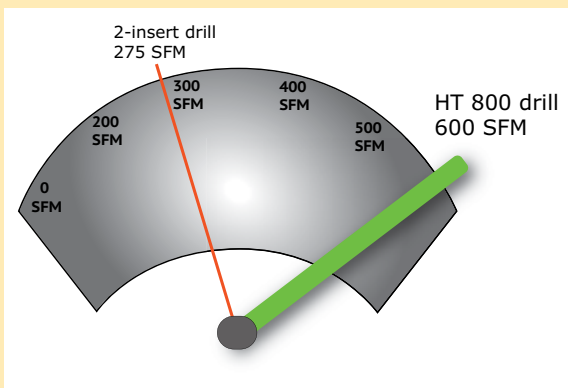

Cycle Time, in seconds

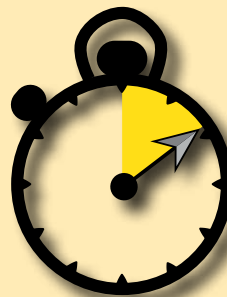

HT800 drill
10 seconds

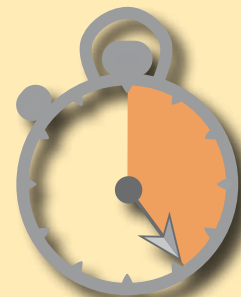

2-insert drill
25 seconds

1 x D for Pilot Drilling and Countersinking

Holders for pilot drilling - Series 4105 Tool steel, coolant fed, nickel plated

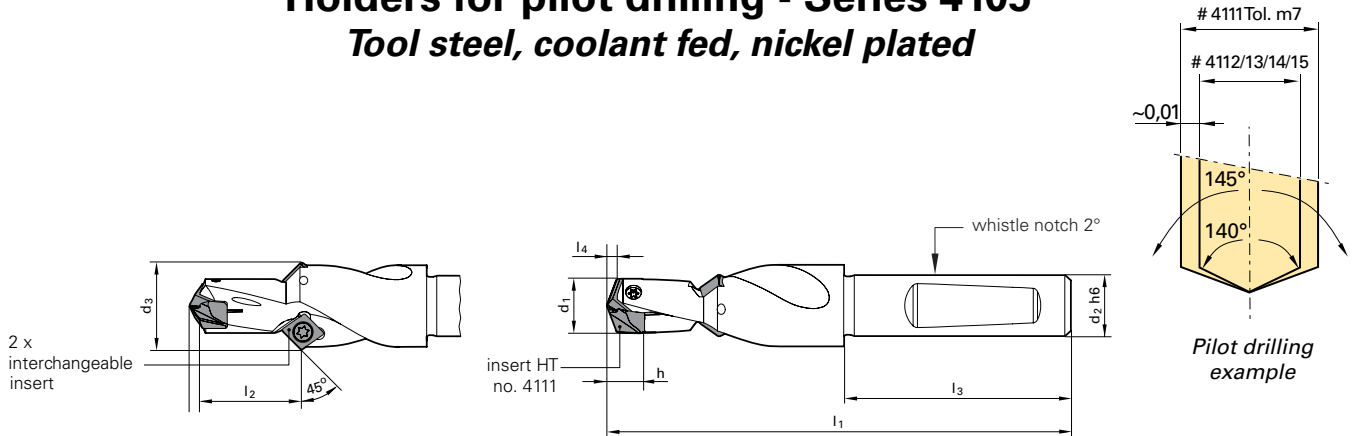

Holder Size	EDP No.	d1 Insert Range mm	d2 mm	d2 in	d3 mm	Series 4105 Holder (1xD w/countersink)		
						l1 mm	l2 mm	l3 mm
110	9041050110000	11.00-11.99	12.00		17.00	81.00	14.80	45.00
	9041050110050	11.00-11.99	12.70	1/2	17.00			
120	9041050120000	12.00-12.99	12.00		18.00	84.00	15.80	45.00
	9041050120050	12.00-12.99	12.70	1/2	18.00			
130	9041050130000	13.00-13.99	14.00		18.00	86.00	16.30	45.00
	9041050130050	13.00-13.99	15.875	5/8	18.00			
140	9041050140000	14.00-15.99	16.00		18.00	93.00	17.40	48.00
	9041050140050	14.00-15.99	15.875	5/8	18.00			
160	9041050160000	16.00-17.99	18.00		20.00	99.00	19.40	48.00
	9041050160050	16.00-17.99	19.05	3/4	20.00			
180	9041050180000	18.00-19.99	20.00		22.00	106.00	21.40	50.00
	9041050180050	18.00-19.99	19.05	3/4	22.00			
200	9041050200000	20.00-21.99	25.00		24.00	117.00	23.40	56.00
	9041050200050	20.00-21.99	25.40	1	24.00			
220	9041050220000	22.00-23.99	25.00		26.00	122.00	25.40	56.00
	9041050220050	22.00-23.99	25.40	1	26.00			
240	9041050240000	24.00-25.99	25.00		28.00	128.00	27.40	56.00
	9041050240050	24.00-25.99	25.40	1	28.00			
260	9041050260000	26.00 - 27.99	32.00		32.00	142.00	28.00	60.00
	9041050260050	26.00 - 27.99	31.75	1 1/4	32.00			
280	9041050280000	28.00 - 29.99	32.00		34.00	147.00	30.00	60.00
	9041050280050	28.00 - 29.99	31.75	1 1/4	34.00			
300	9041050300000	30.00 - 31.99	32.00		38.00	152.00	32.00	60.00
	9041050300050	30.00 - 31.99	31.75	1 1/4	38.00			
320	9041050320000	32.00 - 35.99	32.00		42.00	163.00	36.00	60.00
	9041050320050	32.00 - 35.99	31.75	1 1/4	42.00			
360	9041050360000	36.00 - 40.00	32.00		46.00	173.00	40.00	60.00
	9041050360050	36.00 - 40.00	31.75	1 1/4	46.00			

Holders are supplied with clamping screw, Guhring no. 4071, and screwdriver, Guhring no. 1612.

HT 800 WP Interchangeable Insert Drills

HOLDERS for drilling - Series 4106 (1.5xD), 4107 (3xD) and 4108 (5xD) Tool steel, coolant fed, nickel plated

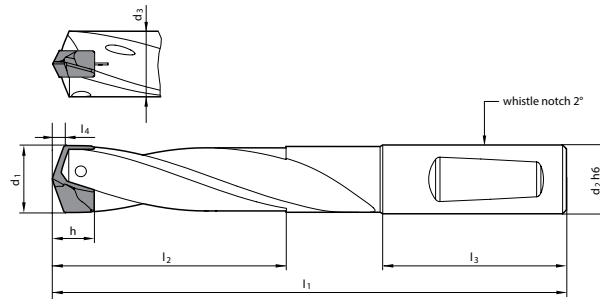

③ *l1 dimensions listed include insert series 4112, 4113, 4114, and 4115 only. Pilot insert series 4111 has different h and l4 dimensions

Holder Size	d1 Insert Range mm	d2		d3 mm	l3 mm	Series 4106 (1.5xD)			Series 4107 (3xD)			Series 4108 (5xD)		
		mm	in			EDP No.	l1* mm	l2 mm	EDP No.	l1* mm	l2 mm	EDP No.	l1* mm	l2 mm
110	11.00-11.49	12.00		10.70	45.00	9041060110000	84.00	19.30	9041070110000	101.00	36.60	9041080110000	124.00	59.60
	11.00-11.49	12.70	1/2	10.70		9041060110050			9041070110050			9041080110050		
115	11.50-11.99	12.00		11.20	45.00	9041060115000	85.00	20.10	9041070115000	103.00	38.10	9041080115000	127.00	62.10
	11.50-11.99	12.70	1/2	11.20		9041060115050			9041070115050			9041080115050		
120	12.00-12.49	12.00		11.70	45.00	9041060120000	87.00	21.00	9041070120000	106.00	39.70	9041080120000	131.00	64.70
	12.00-12.49	12.70	1/2	11.70		9041060120050			9041070120050			9041080120050		
125	12.50-12.99	14.00		12.20	45.00	9041060125000	89.00	21.90	9041070125000	108.00	41.30	9041080125000	134.00	67.30
	12.50-12.99	15.875	5/8	12.20		9041060125050			9041070125050			9041080125050		
130	13.00-13.49	14.00		12.70	45.00	9041060130000	90.00	22.60	9041070130000	110.00	42.90	9041080130000	137.00	69.90
	13.00-13.49	15.875	5/8	12.70		9041060130050			9041070130050			9041080130050		
135	13.50-13.99	14.00		13.20	45.00	9041060135000	92.00	23.60	9041070135000	113.00	44.60	9041080135000	141.00	72.60
	13.50-13.99	15.875	5/8	13.20		9041060135050			9041070135050			9041080135050		
140	14.00-14.49	14.00		13.70	45.00	9041060140000	93.00	24.50	9041070140000	115.00	46.20	9041080140000	144.00	75.20
	14.00-14.49	15.875	5/8	13.70		9041060140050			9041070140050			9041080140050		
145	14.50-14.99	16.00		14.20	48.00	9041060145000	98.00	25.30	9041070145000	120.00	47.80	9041080145000	150.00	77.80
	14.50-14.99	15.875	5/8	14.20		9041060145050			9041070145050			9041080145050		
150	15.00-15.49	16.00		14.70	48.00	9041060150000	100.00	26.10	9041070150000	123.00	49.30	9041080150000	154.00	80.30
	15.00-15.49	15.875	5/8	14.70		9041060150050			9041070150050			9041080150050		
155	15.50-15.99	16.00		15.20	48.00	9041060155000	101.00	27.00	9041070155000	125.00	50.90	9041080155000	157.00	82.90
	15.50-15.99	15.875	5/8	15.20		9041060155050			9041070155050			9041080155050		
160	16.00-16.49	16.00		15.70	48.00	9041060160000	102.00	27.80	9041070160000	127.00	52.90	9041080160000	160.00	85.90
	16.00-16.49	15.875	5/8	15.70		9041060160050			9041070160050			9041080160050		
165	16.50-16.99	18.00		16.20	48.00	9041060165000	105.00	28.70	9041070165000	130.00	54.10	9041080165000	164.00	88.10
	16.50-16.99	19.05	3/4	16.20		9041060165050			9041070165050			9041080165050		
170	17.00-17.49	18.00		16.70	48.00	9041060170000	106.00	29.60	9041070170000	132.00	55.80	9041080170000	167.00	90.80
	17.00-17.49	19.05	3/4	16.70		9041060170050			9041070170050			9041080170050		
175	17.50-17.99	18.00		17.20	48.00	9041060175000	107.00	30.40	9041070175000	134.00	57.40	9041080175000	170.00	93.40
	17.50-17.99	19.05	3/4	17.20		9041060175050			9041070175050			9041080175050		
180	18.00-18.49	18.00		17.70	48.00	9041060180000	109.00	31.20	9041070180000	137.00	58.90	9041080180000	174.00	95.90
	18.00-18.49	19.05	3/4	17.70		9041060180050			9041070180050			9041080180050		
185	18.50-18.99	20.00		18.20	50.00	9041060185000	113.00	32.10	9041070185000	141.00	60.50	9041080185000	179.00	98.50
	18.50-18.99	19.05	3/4	18.20		9041060185050			9041070185050			9041080185050		
190	19.00-19.49	20.00		18.70	50.00	9041060190000	114.00	32.90	9041070190000	143.00	62.10	9041080190000	182.00	101.10
	19.00-19.49	19.05	3/4	18.70		9041060190050			9041070190050			9041080190050		
195	19.50-19.99	20.00		19.20	50.00	9041060195000	116.00	33.70	9041070195000	146.00	63.70	9041080195000	186.00	103.70
	19.50-19.99	19.05	3/4	19.20		9041060195050			9041070195050			9041080195050		

Holders are supplied with clamping screw, Guhring no. 4071, and screwdriver, Guhring no. 1612.

Holders



③

Continued from previous page

Holder Size	d1 Insert Range mm	d2 mm	d2 in	d3 mm	l3 mm	Series 4106 (1.5xD)			Series 4107 (3xD)			Series 4108 (5xD)		
						EDP No.	l1* mm	l2 mm	EDP No.	l1* mm	l2 mm	EDP No.	l1* mm	l2 mm
200	20.00-20.49	20.00		19.70	50.00	9041060200000	117.00	34.60	9041070200000	148.00	65.30	9041080200000	189.00	106.30
	20.00-20.49	19.05	3/4	19.70	9041060200050	9041070200050			9041080200050					
205	20.50-20.99	25.00		20.20	56.00	9041060205000	128.00	35.50	9041070205000	159.00	67.00	9041080205000	201.00	109.00
	20.50-20.99	25.40	1	20.20	9041060205050	9041070205050			9041080205050					
210	21.00-21.49	25.00		20.70	56.00	9041060210000	129.00	36.40	9041070210000	161.00	68.60	9041080210000	204.00	111.60
	21.00-21.49	25.40	1	20.70	9041060210050	9041070210050			9041080210050					
215	21.50-21.99	25.00		21.20	56.00	9041060215000	130.00	37.20	9041070215000	163.00	70.10	9041080215000	207.00	114.10
	21.50-21.99	25.40	1	21.20	9041060215050	9041070215050			9041080215050					
220	22.00-22.49	25.00		21.70	56.00	9041060220000	131.00	38.00	9041070220000	165.00	71.70	9041080220000	210.00	116.70
	22.00-22.49	25.40	1	21.70	9041060220050	9041070220050			9041080220050					
225	22.50-22.99	25.00		22.20	56.00	9041060225000	134.00	38.90	9041070225000	168.00	73.30	9041080225000	214.00	119.30
	22.50-22.99	25.40	1	22.20	9041060225050	9041070225050			9041080225050					
230	23.00-23.49	25.00		22.70	56.00	9041060230000	135.00	39.80	9041070230000	170.00	74.90	9041080230000	217.00	121.90
	23.00-23.49	25.40	1	22.70	9041060230050	9041070230050			9041080230050					
235	23.50-23.99	25.00		23.20	56.00	9041060235000	137.00	40.60	9041070235000	173.00	76.50	9041080235000	221.00	124.50
	23.50-23.99	25.40	1	23.20	9041060235050	9041070235050			9041080235050					
240	24.00-24.49	25.00		23.70	56.00	9041060240000	138.00	41.50	9041070240000	175.00	78.10	9041080240000	224.00	127.10
	24.00-24.49	25.40	1	23.70	9041060240050	9041070240050			9041080240050					
245	24.50-24.99	25.00		24.20	56.00	9041060245000	140.00	42.30	9041070245000	177.00	79.70	9041080245000	227.00	129.70
	24.50-24.99	25.40	1	24.20	9041060245050	9041070245050			9041080245050					
250	25.00-25.49	25.00		24.70	56.00	9041060250000	142.00	43.20	9041070250000	180.00	81.30	9041080250000	231.00	132.30
	25.00-25.49	25.40	1	24.70	9041060250050	9041070250050			9041080250050					
255	25.50-25.99	32.00		25.20	60.00	9041060255000	148.00	44.00	9041070255000	187.00	82.90	9041080255000	239.00	134.90
	25.50-25.99	31.75	1 1/4	25.20	9041060255050	9041070255050			9041080255050					
260	26.00-26.49	32.00		25.70	60.00	9041060260000	151.00	44.30	9041070260000	191.00	84.00	9041080260000	244.00	137.00
	26.00-26.49	31.75	1 1/4	25.70	9041060260050	9041070260050			9041080260050					
265	26.50-26.99	32.00		26.20	60.00	9041060265000	153.00	45.10	9041070265000	193.00	86.10	9041080265000	247.00	140.00
	26.50-26.99	31.75	1 1/4	26.20	9041060265050	9041070265050			9041080265050					
270	27.00-27.49	32.00		26.70	60.00	9041060270000	155.00	46.00	9041070270000	196.00	87.20	9041080270000	251.00	142.00
	27.00-27.49	31.75	1 1/4	26.70	9041060270050	9041070270050			9041080270050					
275	27.50-27.99	32.00		27.20	60.00	9041060275000	156.00	46.80	9041070275000	198.00	88.90	9041080275000	254.00	144.80
	27.50-27.99	31.75	1 1/4	27.20	9041060275050	9041070275050			9041080275050					
280	28.00-28.49	32.00		27.70	60.00	9041060280000	157.00	47.70	9041070280000	200.00	90.50	9041080280000	257.00	147.40
	28.00-28.49	31.75	1 1/4	27.70	9041060280050	9041070280050			9041080280050					
285	28.50-28.99	32.00		28.20	60.00	9041060285000	159.00	48.50	9041070285000	202.00	92.50	9041080285000	260.00	150.40
	28.50-28.99	31.75	1 1/4	28.20	9041060285050	9041070285050			9041080285050					

Holders are supplied with clamping screw, Guhring no. 4071, and screwdriver, Guhring no. 1612.

HT 800 WP Interchangeable Insert Drills

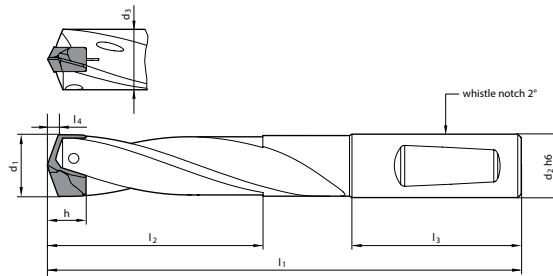

③

Continued from previous page

Holder Size	d1 Insert Range mm	d2 mm	d2 in	d3 mm	l3 mm	Series 4106 (1.5xD)			Series 4107 (3xD)			Series 4108 (5xD)		
						EDP No.	l1* mm	l2 mm	EDP No.	l1* mm	l2 mm	EDP No.	l1* mm	l2 mm
290	29.00-29.49	32.00		28.70	60.00	9041060290000	161.00	49.40	9041070290000	205.00	94.60	9041080290000	264.00	153.50
	29.00-29.49	31.75	1 1/4	28.70	60.00	9041060290050			9041070290050			9041080290050		
295	29.50-29.99	32.00		29.20	60.00	9041060295000	162.00	50.20	9041070295000	207.00	95.10	9041080295000	267.00	155.10
	29.50-29.99	31.75	1 1/4	29.20	60.00	9041060295050			9041070295050			9041080295050		
300	30.00-30.49	32.00		29.70	60.00	9041060300000	164.00	50.90	9041070300000	210.00	96.70	9041080300000	271.00	157.60
	30.00-30.49	31.75	1 1/4	29.70	60.00	9041060300050			9041070300050			9041080300050		
305	30.50-30.99	32.00		30.20	60.00	9041060305000	166.00	51.70	9041070305000	212.00	98.30	9041080305000	274.00	160.20
	30.50-30.99	31.75	1 1/4	30.20	60.00	9041060305050			9041070305050			9041080305050		
310	31.00-31.49	32.00		30.70	60.00	9041060310000	167.00	52.60	9041070310000	214.00	99.80	9041080310000	277.00	162.80
	31.00-31.49	31.75	1 1/4	30.70	60.00	9041060310050			9041070310050			9041080310050		
315	31.50-31.99	32.00		31.20	60.00	9041060315000	168.00	53.40	9041070315000	216.00	101.40	9041080315000	280.00	165.40
	31.50-31.99	31.75	1 1/4	31.20	60.00	9041060315050			9041070315050			9041080315050		
320	32.00-32.99	32.00		31.70	60.00	9041060320000	172.00	55.10	9041070320000	221.00	104.60	9041080320000	287.00	170.60
	32.00-32.99	31.75	1 1/4	31.70	60.00	9041060320050			9041070320050			9041080320050		
330	33.00-33.99	32.00		32.70	60.00	9041060330000	175.00	56.80	9041070330000	226.00	107.80	9041080330000	294.00	175.80
	33.00-33.99	31.75	1 1/4	32.70	60.00	9041060330050			9041070330050			9041080330050		
340	34.00-34.99	32.00		33.70	60.00	9041060340050	178.00	58.50	9041070340050	230.00	111.00	9041080340050	300.00	181.00
	34.00-34.99	31.75	1 1/4	33.70	60.00	9041060340050			9041070340050			9041080340050		
350	35.00-35.99	32.00		34.70	60.00	9041060350000	181.00	60.20	9041070350000	235.00	114.20	9041080350000	307.00	186.20
	35.00-35.99	31.75	1 1/4	34.70	60.00	9041060350050			9041070350050			9041080350050		
360	36.00-36.99	32.00		35.70	60.00	9041060360000	184.00	61.80	9041070360000	240.00	117.30	9041080360000	314.00	191.30
	36.00-36.99	31.75	1 1/4	35.70	60.00	9041060360050			9041070360050			9041080360050		
370	37.00-37.99	32.00		36.70	60.00	9041060370000	188.00	63.50	9041070370000	245.00	120.50	9041080370000	321.00	196.50
	37.00-37.99	31.75	1 1/4	36.70	60.00	9041060370050			9041070370050			9041080370050		
380	38.00-38.99	32.00		37.70	60.00	9041060380000	191.00	65.20	9041070380000	249.00	123.70	9041080380000	327.00	201.70
	38.00-38.99	31.75	1 1/4	37.70	60.00	9041060380050			9041070380050			9041080380050		
390	39.00-40.00	32.00		38.70	60.00	9041060390000	194.00	66.90	9041070390000	254.00	126.90	9041080390000	334.00	206.90
	39.00-40.00	31.75	1 1/4	38.70	60.00	9041060390050			9041070390050			9041080390050		

Holders are supplied with clamping screw, Guhring no. 4071, and screwdriver, Guhring no. 1612.

HT 800 WP Interchangeable Insert Drills

Extra length holders for drilling - Series 4109 (7xD) and 4110 (10xD) Tool steel, coolant fed, nickel plated

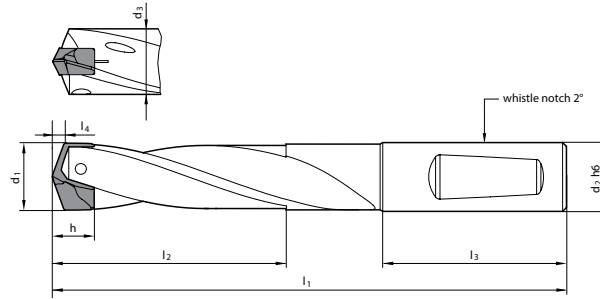

③ *l1 dimensions listed include insert series 4112, 4113, 4114, and 4115 only. Pilot insert series 4111 has different h and l4 dimensions

Holder Size	d1 Insert Range mm	d2 mm	d2 in	d3 mm	l3 mm	Series 4109 (7xD)			Series 4110 (10xD)		
						EDP No.	l1* mm	l2 mm	EDP No.	l1* mm	l2 mm
110	11.00-11.49	12.00		10.70	45.00	9041090110000	147.00	82.60	9041100110000	182.00	117.10
	11.00-11.49	12.70	1/2	10.70		9041090110050			9041100110050		
115	11.50-11.99	12.00		11.20	45.00	9041090115000	151.00	86.10	9041100115000	187.00	122.10
	11.50-11.99	12.70	1/2	11.20		9041090115050			9041100115050		
120	12.00-12.49	12.00		11.70	45.00	9041090120000	156.00	89.70	9041100120000	194.00	127.20
	12.00-12.49	12.70	1/2	11.70		9041090120050			9041100120050		
125	12.50-12.99	14.00		12.20	45.00	9041090125000	160.00	93.30	9041100125000	199.00	132.30
	12.50-12.99	15.875	5/8	12.20		9041090125050			9041100125050		
130	13.00-13.49	14.00		12.70	45.00	9041090130000	164.00	96.90	9041100130000	205.00	137.50
	13.00-13.49	15.875	5/8	12.70		9041090130050			9041100130050		
135	13.50-13.99	14.00		13.20	45.00	9041090135000	169.00	100.60	9041100135000	211.00	142.50
	13.50-13.99	15.875	5/8	13.20		9041090135050			9041100135050		
140	14.00-14.49	14.00		13.70	45.00	9041090140000	173.00	104.20	9041100140000	217.00	147.70
	14.00-14.49	15.875	5/8	13.70		9041090140050			9041100140050		
145	14.50-14.99	16.00		14.20	48.00	9041090145000	180.00	107.80	9041100145000	225.00	152.80
	14.50-14.99	15.875	5/8	14.20		9041090145050			9041100145050		
150	15.00-15.49	16.00		14.70	48.00	9041090150000	185.00	111.30	9041100150000	232.00	157.80
	15.00-15.49	15.875	5/8	14.70		9041090150050			9041100150050		
155	15.50-15.99	16.00		15.20	48.00	9041090155000	189.00	114.90	9041100155000	237.00	162.90
	15.50-15.99	15.875	5/8	15.20		9041090155050			9041100155050		
160	16.00-16.49	16.00		15.70	48.00	9041090160000	193.00	118.90	9041100160000	243.00	168.00
	16.00-16.49	15.875	5/8	15.70		9041090160050			9041100160050		
165	16.50-16.99	18.00		16.20	48.00	9041090165000	198.00	122.10	9041100165000	249.00	173.10
	16.50-16.99	19.05	3/4	16.20		9041090165050			9041100165050		
170	17.00-17.49	18.00		16.70	48.00	9041090170000	202.00	125.80	9041100170000	255.00	178.30
	17.00-17.49	19.05	3/4	16.70		9041090170050			9041100170050		
175	17.50-17.99	18.00		17.20	48.00	9041090175000	206.00	129.40	9041100175000	260.00	183.50
	17.50-17.99	19.05	3/4	17.20		9041090175050			9041100175050		
180	18.00-18.49	18.00		17.70	48.00	9041090180000	211.00	132.90	9041100180000	267.00	188.40
	18.00-18.49	19.05	3/4	17.70		9041090180050			9041100180050		

Holders are supplied with clamping screw, Guhring no. 4071, and screwdriver, Guhring no. 1612.

Holders

For drilling depths over 5xD, we generally recommend spot drilling prior to finish drilling to depth. Drilling depths over 7xD will typically require use of a series 4105 pilot drill with a series 4111 (145°) insert.

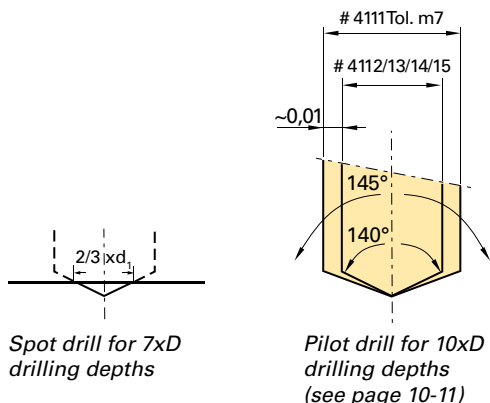

③

Holder Size	d1 Insert Range mm	d2 mm	d2 in	d3 mm	l3 mm	Series 4109 (7xD)			Series 4110 (10xD)		
						EDP No.	l1* mm	l2 mm	EDP No.	l1* mm	l2 mm
185	18.50-18.99	20.00		18.20	50.00	9041090185000	217.00	136.50	9041100185000	274.00	193.50
	18.50-18.99	19.05	3/4	18.20		9041090185050			9041100185050		
190	19.00-19.49	20.00		18.70	50.00	9041090190000	221.00	140.10	9041100190000	280.00	198.70
	19.00-19.49	19.05	3/4	18.70		9041090190050			9041100190050		
195	19.50-19.99	20.00		19.20	50.00	9041090195000	226.00	143.70	9041100195000	286.00	203.70
	19.50-19.99	19.05	3/4	19.20		9041090195050			9041100195050		
200	20.00-20.49	20.00		19.70	50.00	9041090200000	230.00	147.30	9041100200000	292.00	208.90
	20.00-20.49	19.05	3/4	19.70		9041090200050			9041100200050		
205	20.50-20.99	25.00		20.20	56.00	9041090205000	243.00	151.00	9041100205000	306.00	214.00
	20.50-20.99	25.40	1	20.20		9041090205050			9041100205050		
210	21.00-21.49	25.00		20.70	56.00	9041090210000	247.00	154.60	9041100210000	312.00	219.10
	21.00-21.49	25.40	1	20.70		9041090210050			9041100210050		
215	21.50-21.99	25.00		21.20	56.00	9041090215000	251.00	158.10	9041100215000	317.00	224.20
	21.50-21.99	25.40	1	21.20		9041090215050			9041100215050		
220	22.00-22.49	25.00		21.70	56.00	9041090220000	255.00	161.70	9041100220000	323.00	229.30
	22.00-22.49	25.40	1	21.70		9041090220050			9041100220050		
225	22.50-22.99	25.00		22.20	56.00	9041090225000	260.00	165.30	9041100225000	329.00	234.40
	22.50-22.99	25.40	1	22.20		9041090225050			9041100225050		
230	23.00-23.49	25.00		22.70	56.00	9041090230000	264.00	168.90	9041100230000	335.00	239.50
	23.00-23.49	25.40	1	22.70		9041090230050			9041100230050		
235	23.50-23.99	25.00		23.20	56.00	9041090235000	269.00	172.50	9041100235000	341.00	244.60
	23.50-23.99	25.40	1	23.20		9041090235050			9041100235050		
240	24.00-24.49	25.00		23.70	56.00	9041090240000	273.00	176.10	9041100240000	347.00	249.70
	24.00-24.49	25.40	1	23.70		9041090240050			9041100240050		
245	24.50-24.99	25.00		24.20	56.00	9041090245000	277.00	179.70	9041100245000	352.00	254.80
	24.50-24.99	25.40	1	24.20		9041090245050			9041100245050		
250	25.00-25.49	25.00		24.70	56.00	9041090250000	282.00	183.30	9041100250000	359.00	259.90
	25.00-25.49	25.40	1	24.70		9041090250050			9041100250050		
255	25.50-25.99	32.00		25.20	60.00	9041090255000	291.00	186.90	9041100255000	369.00	265.00
	25.50-25.99	31.75	1 1/4	25.20		9041090255050			9041100255050		

Holders are supplied with clamping screw, Guhring no. 4071, and screwdriver, Guhring no. 1612.

HT 800 WP Interchangeable Insert Drills

Extra length holders for drilling - Series 4109 (7xD) and 4110 (10xD) Tool steel, coolant fed, nickel plated

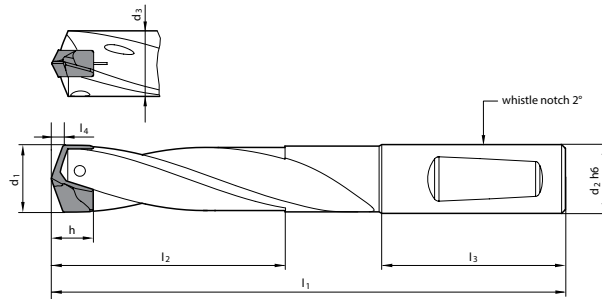

③ Continued from previous page

Holder Size	d1 Insert Range mm	d2 mm	d2 in	d3 mm	l3 mm	Series 4109 (7xD)			Series 4110 (10xD)		
						EDP No.	l1* mm	l2 mm	EDP No.	l1* mm	l2 mm
260	26.00 - 26.49	32.00		25.70	60.00	9041090260000	297.00	190.00	9041100260000	377.00	270.00
	26.00 - 26.49	31.75	1 1/4	25.70		9041090260050			9041100260050		
265	26.50 - 26.99	32.00		26.20	60.00	9041090265000	301.00	194.00	9041100265000	382.00	275.00
	26.50 - 26.99	31.75	1 1/4	26.20		9041090265050			9041100265050		
270	27.00 - 27.49	32.00		26.70	60.00	9041090270000	306.00	197.20	9041100270000	388.00	280.10
	27.00 - 27.49	31.75	1 1/4	26.70		9041090270050			9041100270050		
275	27.50 - 27.99	32.00		27.20	60.00	9041090275000	310.00	200.80	9041100275000	394.00	285.20
	27.50 - 27.99	31.75	1 1/4	27.20		9041090275050			9041100275050		
280	28.00 - 28.49	32.00		27.70	60.00	9041090280000	314.00	204.40	9041100280000	400.00	290.30
	28.00 - 28.49	31.75	1 1/4	27.70		9041090280050			9041100280050		
285	28.50 - 28.99	32.00		28.20	60.00	9041090285000	318.00	208.40	9041100285000	405.00	295.40
	28.50 - 28.99	31.75	1 1/4	28.20		9041090285050			9041100285050		
290	29.00 - 29.49	32.00		28.70	60.00	9041090290000	323.00	212.50	9041100290000	412.00	300.50
	29.00 - 29.49	31.75	1 1/4	28.70		9041090290050			9041100290050		
295	29.50 - 29.99	32.00		29.20	60.00	9041090295000	327.00	215.10	9041100295000	418.00	305.60
	29.50 - 29.99	31.75	1 1/4	29.20		9041090295050			9041100295050		
300	30.00 - 30.49	32.00		29.70	60.00	9041090300000	332.00	218.60	9041100300000	424.00	310.60
	30.00 - 30.49	31.75	1 1/4	29.70		9041090300050			9041100300050		
305	30.50 - 30.99	32.00		30.20	60.00	9041090305000	336.00	222.20	9041100305000	429.00	315.70
	30.50 - 30.99	31.75	1 1/4	30.20		9041090305050			9041100305050		
310	31.00 - 31.49	32.00		30.70	60.00	9041090310000	340.00	225.80	9041100310000	435.00	320.80
	31.00 - 31.49	31.75	1 1/4	30.70		9041090310050			9041100310050		
315	31.50 - 31.99	32.00		31.20	60.00	9041090315000	344.00	229.40	9041100315000	441.00	325.90
	31.50 - 31.99	31.75	1 1/4	31.20		9041090315050			9041100315050		

Holders are supplied with clamping screw, Guhring no. 4071, and screwdriver, Guhring no. 1612.

**Clamping screws
for HT 800 inserts**

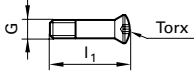

Series 4071

For holder size	Size	OAL	with Torx	EDP No.
110/115	M2.2	9.50	T7	9040710022000
120/125	M2.2	10.50	T7	9040710022010
130/135	M2.5	11.40	T8	9040710025000
140/145	M3	12.10	T9	9040710030000
150/155	M3	13.10	T9	9040710030010
160 - 175	M3.5	14.25	T10	9040710035000
180 - 195	M4	16.00	T15	9040710040000
200 - 215	M4.5	18.00	T15	9040710045000
220 - 235	M5	19.75	T20	9040710050000
240 - 255	M5	21.75	T20	9040710050010
260 - 295	M5	23.40	T20	9040710050030
300 - 315	M6	27.00	T25	9040710060000
320 - 350	M6	28.50	T25	9040710060010
360 - 390	M6	32.50	T25	9040710060020

**Clamping screws
for chamfering inserts**

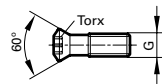



Series 6128

For holder size	Size	OAL	with Torx	EDP No.
110 - 140	M2.0	5.5	T6	9061280020000
160 - 240	M2.5	5.3	T7	9061280025000
300 - 360	M4.0	9.5	T15	9061280040000

Torx driver



Series 4915

Type	Drive	l1 mm	Tightening torque (Nm)	EDP No.
A	1/4" 	160.00	0.8 - 2	9049150020000
A	1/4" 	160.00	2 - 8	9049150080000
A	1/4" 	200.00	5 - 14	9049150140000

Screw driver









Series 1612

For holder size	for Torx	EDP No.
Pilot holder 110 - 140	T6	9016120060000
Pilot holder 160 - 280	T7	9016120070000
110 - 125	T7	9016120070010
130/135	T8	9016120080010
140 - 155	T9	9016120090010
160 - 175	T10	9016120100010
Pilot holder 300 - 360	T15	9016120150000
180 - 215	T15	9016120150010
220-295	T20	9016120200010
300 - 390	T25	9016120250000

Torx Bits



Series 4917

for Torx	Drive	l1 mm	EDP No.
T7	1/4" 	25	9049170070000
T8	1/4" 	25	9049170080000
T9	1/4" 	25	9049170090000
T10	1/4" 	25	9049170100000
T15	1/4" 	25	9049170150000
T20	1/4" 	25	9049170200000
T25	1/4" 	25	9049170250000

Torque values for clamping screws

Diameter range (mm)	11.0 - 12.99	13.0 - 13.99	14.0 - 15.99	16.0 - 17.99	18.0 - 19.99	20.0 - 21.99	22.0 - 25.99	30.0 - 40.00
Thread	M2.2	M2.5	M3	M3.5	M4	M4.5	M5	M6
Torx size	T7	T8	T9	T10	T15	T15	T20	T25
Tightening torque [Nm]	0.80	1.00	1.70	2.70	4.00	6.0	8.00	14.0

Details apply to thread locking (Loctite).

Holders are supplied with clamping screw, Guhring no. 4071, and screwdriver, Guhring no. 1612.

Using These Tables. The Speeds & Feeds listed below are conservative recommendations for initial setup. In actual use, depending on the machining environment and workpiece material, significantly higher speeds and feeds may be achievable. Using the below as a starting point, cutting speed/feed can be gradually adjusted upwards until the optimum settings per application are found. Questions? Contact us by telephone at (800) 776-6170.

Series # 4105/4106 body (1xD/1.5xD) with # 4111 insert

Material group	Hardness	SFM	Feed Rate - IPR									
			1/16 in. 1.590 mm	1/8 in. 3.170 mm	1/4 in. 6.350 mm	3/8 in. 9.520 mm	1/2 in. 12.700mm	5/8 in. 15.870mm	3/4 in. 19.050mm	1 in. 25.400mm	1 1/4 in. 31.75mm	1 1/2 in. 38.10mm
Common structural steels	≤ 100 BHN	425	•	•	•	•	0.010	0.012	0.016	0.020	0.020	0.025
	100-260 BHN	360	•	•	•	•	0.008	0.010	0.012	0.016	0.016	0.020
Free-cutting steels	≤ 24 HRC	425	•	•	•	•	0.012	0.016	0.020	0.025	0.025	0.031
	24-30 HRC	360	•	•	•	•	0.010	0.012	0.016	0.020	0.020	0.025
Unalloyed heat-treatable steels	≤ 16 HRC	425	•	•	•	•	0.010	0.012	0.016	0.020	0.020	0.025
	16-24 HRC	410	•	•	•	•	0.010	0.012	0.016	0.020	0.020	0.025
	24-30 HRC	360	•	•	•	•	0.008	0.010	0.012	0.016	0.016	0.020
Alloyed heat-treatable steels	24-30 HRC	360	•	•	•	•	0.010	0.012	0.016	0.020	0.020	0.025
	30-38 HRC	295	•	•	•	•	0.008	0.010	0.012	0.016	0.016	0.020
Unalloyed case hardened steels	≤ 230 BHN	425	•	•	•	•	0.012	0.016	0.020	0.025	0.025	0.031
Alloyed case hardened steels	24-30 HRC	360	•	•	•	•	0.010	0.012	0.016	0.020	0.020	0.025
	30-38 HRC	230	•	•	•	•	0.006	0.008	0.010	0.012	0.012	0.016
Nitriding steels	24-30 HRC	345	•	•	•	•	0.008	0.010	0.012	0.016	0.016	0.020
	30-38 HRC	230	•	•	•	•	0.006	0.008	0.010	0.012	0.012	0.016
Tool steels	≤ 24 HRC	195	•	•	•	•	0.008	0.010	0.012	0.016	0.016	0.020
	24-30 HRC	180	•	•	•	•	0.006	0.008	0.010	0.012	0.012	0.016
High speed steels	14-30 HRC	180	•	•	•	•	0.005	0.006	0.008	0.010	0.010	0.012
Spring steels	≤ 330 BHN	165	•	•	•	•	0.004	0.005	0.006	0.008	0.008	0.010
Stainless steels, sulphured austenitic	≤ 24 HRC	180	•	•	•	•	0.005	0.006	0.008	0.010	0.010	0.012
Stainless steels, austenitic	≤ 24 HRC	130	•	•	•	•	0.005	0.006	0.008	0.010	0.010	0.012
Stainless steels, martensitic	≤ 24 HRC	115	•	•	•	•	0.005	0.006	0.008	0.010	0.010	0.012
Hardened steels	40-48 HRC	80	•	•	•	•	0.004	0.005	0.006	0.008	0.008	0.010
	48-60 HRC	•	•	•	•	•	•	•	•	•	•	•
Special alloys	≤ 38 HRC	80	•	•	•	•	0.004	0.005	0.006	0.008	0.008	0.010
Cast iron	≤ 240 BHN	330	•	•	•	•	0.010	0.012	0.016	0.020	0.020	0.025
	240-300 BHN	295	•	•	•	•	0.010	0.012	0.016	0.020	0.020	0.025
New Cast Materials CGI & ADI	220-300 BHN	260	•	•	•	•	0.008	0.010	0.012	0.016	0.016	0.020
New Cast Materials CGI & ADI	350-410 BHN	260	•	•	•	•	0.008	0.010	0.012	0.016	0.016	0.020
Spheroidal graphite iron and malleable cast iron	≤ 240 BHN	395	•	•	•	•	0.012	0.016	0.020	0.025	0.025	0.031
Chilled cast iron	240-300 BHN	330	•	•	•	•	0.010	0.012	0.016	0.020	0.020	0.025
	≤ 350 BHN	295	•	•	•	•	0.010	0.012	0.016	0.020	0.020	0.025
Ti and Ti-alloys	≤ 24 HRC	130	•	•	•	•	0.005	0.006	0.008	0.010	0.010	0.012
	24-38 HRC	115	•	•	•	•	0.004	0.005	0.006	0.008	0.008	0.010
Aluminum and Al-alloys	≤ 120 BHN	655	•	•	•	•	0.012	0.016	0.020	0.025	0.025	0.031
Al wrought alloys	≤ 150 BHN	590	•	•	•	•	0.012	0.016	0.020	0.025	0.025	0.031
Al cast alloys	≤ 10% Si	490	•	•	•	•	0.012	0.016	0.020	0.025	0.025	0.031
	> 20% Si	395	•	•	•	•	0.012	0.016	0.020	0.025	0.025	0.031
Magnesium alloys	≤ 150 BHN	590	•	•	•	•	0.012	0.016	0.020	0.025	0.025	0.031
Copper, low-alloyed	≤ 120 BHN	230	•	•	•	•	0.010	0.012	0.016	0.020	0.020	0.025
Brass, short-chipping	≤ 200 BHN	590	•	•	•	•	0.012	0.016	0.020	0.025	0.025	0.031
Brass, long-chipping	≤ 200 BHN	395	•	•	•	•	0.010	0.012	0.016	0.020	0.020	0.025
Bronze, short-chipping	≤ 200 BHN	230	•	•	•	•	0.010	0.012	0.016	0.020	0.020	0.025
	200-260 BHN	165	•	•	•	•	0.010	0.012	0.016	0.020	0.020	0.025
Bronze, long-chipping	≤ 24 HRC	150	•	•	•	•	0.010	0.012	0.016	0.020	0.020	0.025
	24-30 HRC	115	•	•	•	•	0.008	0.010	0.012	0.016	0.016	0.020

Series # 4105/4106 body (1xD/1.5xD) with # 4112 insert

Material group	Hardness	SFM	Feed Rate - IPR									
			1/16 in. 1.590 mm	1/8 in. 3.170 mm	1/4 in. 6.350 mm	3/8 in. 9.520 mm	1/2 in. 12.700mm	5/8 in. 15.870mm	3/4 in. 19.050mm	1 in. 25.400mm	1 1/4 in. 31.75mm	1 1/2 in. 38.10mm
Common structural steels	≤ 100 BHN	425	•	•	•	•	0.010	0.012	0.016	0.020	0.020	0.025
	100-260 BHN	360	•	•	•	•	0.008	0.010	0.012	0.016	0.016	0.020
Free-cutting steels	≤ 24 HRC	425	•	•	•	•	0.012	0.016	0.020	0.025	0.025	0.031
	24-30 HRC	360	•	•	•	•	0.010	0.012	0.016	0.020	0.020	0.025
Unalloyed heat-treatable steels	≤ 16 HRC	425	•	•	•	•	0.010	0.012	0.016	0.020	0.020	0.025
	16-24 HRC	410	•	•	•	•	0.010	0.012	0.016	0.020	0.020	0.025
	24-30 HRC	360	•	•	•	•	0.008	0.010	0.012	0.016	0.016	0.020
Alloyed heat-treatable steels	24-30 HRC	360	•	•	•	•	0.010	0.012	0.016	0.020	0.020	0.025
	30-38 HRC	295	•	•	•	•	0.008	0.010	0.012	0.016	0.016	0.020
Unalloyed case hardened steels	≤ 230 BHN	425	•	•	•	•	0.012	0.016	0.020	0.025	0.025	0.031
Alloyed case hardened steels	24-30 HRC	360	•	•	•	•	0.010	0.012	0.016	0.020	0.020	0.025
	30-38 HRC	230	•	•	•	•	0.006	0.008	0.010	0.012	0.012	0.016
Nitriding steels	24-30 HRC	345	•	•	•	•	0.008	0.010	0.012	0.016	0.016	0.020
	30-38 HRC	230	•	•	•	•	0.006	0.008	0.010	0.012	0.012	0.016
Tool steels	≤ 24 HRC	195	•	•	•	•	0.008	0.010	0.012	0.016	0.016	0.020
	24-30 HRC	180	•	•	•	•	0.006	0.008	0.010	0.012	0.012	0.016
High speed steels	14-30 HRC	180	•	•	•	•	0.005	0.006	0.008	0.010	0.010	0.012
Spring steels	≤ 330 BHN	165	•	•	•	•	0.004	0.005	0.006	0.008	0.008	0.010
Stainless steels, sulphured austenitic	≤ 24 HRC	180	•	•	•	•	0.005	0.006	0.008	0.010	0.010	0.012
Stainless steels, austenitic	≤ 24 HRC	130	•	•	•	•	0.005	0.006	0.008	0.010	0.010	0.012
Stainless steels, martensitic	≤ 24 HRC	115	•	•	•	•	0.005	0.006	0.008	0.010	0.010	0.012
Hardened steels	40-48 HRC	80	•	•	•	•	0.004	0.005	0.006	0.008	0.008	0.010
	48-60 HRC	•	•	•	•	•	•	•	•	•	•	•
Special alloys	≤ 38 HRC	80	•	•	•	•	0.004	0.005	0.006	0.008	0.008	0.010
Ti and Ti-alloys	≤ 24 HRC	130	•	•	•	•	0.005	0.006	0.008	0.010	0.010	0.012
	24-38 HRC	115	•	•	•	•	0.004	0.005	0.006	0.008	0.008	0.010

$$\text{RPM} = \frac{\text{SFM}}{\text{DIAM. in.}} \times 3.82$$

$$\text{IPM} = \text{IPR} \times \text{RPM}$$

$$\frac{\text{HOLE DEPTH in.}}{\text{IPM}} \times 60 = \text{Cut Time}$$

$$\text{mm} = \text{in.} \times 25.40$$

$$\text{m/min.} = \text{SFM} \div 3.28$$

$$\text{mm/rev.} = \text{IPR} \times 25.40$$

$$\text{Bar} = \text{PSI} \div 14.50$$

$$\text{Liter} = \text{Gal.} \div 3.79$$

Series # 4105/4106 body (1xD/1.5xD) with # 4113 insert

Material group	Hardness	SFM	Feed Rate - IPR									
			1/16 in. 1.590 mm	1/8 in. 3.170 mm	1/4 in. 6.350 mm	3/8 in. 9.520 mm	1/2 in. 12.700mm	5/8 in. 15.870mm	3/4 in. 19.050mm	1 in. 25.400mm	1 1/4 in. 31.75mm	1 1/2 in. 38.10mm
Cast iron	≤240 Bhn	330	•	•	•	•	0.010	0.012	0.016	0.020	0.020	0.025
	240-300 Bhn	295	•	•	•	•	0.010	0.012	0.016	0.020	0.020	0.025
New Cast Materials CGI & ADI	220-300 Bhn	260	•	•	•	•	0.008	0.010	0.012	0.016	0.016	0.020
New Cast Materials CGI & ADI	350-410 Bhn	260	•	•	•	•	0.008	0.010	0.012	0.016	0.016	0.020
Spheroidal graphite iron and malleable cast iron	≤240 Bhn	395	•	•	•	•	0.012	0.016	0.020	0.025	0.025	0.031
	240-300 Bhn	330	•	•	•	•	0.010	0.012	0.016	0.020	0.020	0.025

Series # 4105/4106 body (1xD/1.5xD) with #4114 insert

Material group	Hardness	SFM	Feed Rate - IPR									
			1/16 in. 1.590 mm	1/8 in. 3.170 mm	1/4 in. 6.350 mm	3/8 in. 9.520 mm	1/2 in. 12.700mm	5/8 in. 15.870mm	3/4 in. 19.050mm	1 in. 25.400mm	1 1/4 in. 31.75mm	1 1/2 in. 38.10mm
Aluminium and Al-alloys	≤120 Bhn	655	•	•	•	•	0.012	0.016	0.020	0.025	0.025	0.031
Al wrought alloys	≤150 Bhn	590	•	•	•	•	0.012	0.016	0.020	0.025	0.025	0.031
Al cast alloys ≤ 10% Si	≤200 Bhn	490	•	•	•	•	0.012	0.016	0.020	0.025	0.025	0.031
Al cast alloys ≤ 24% Si	≤200 Bhn	395	•	•	•	•	0.012	0.016	0.020	0.025	0.025	0.031
Magnesium alloys	≤150 Bhn	590	•	•	•	•	0.012	0.016	0.020	0.025	0.025	0.031
Copper, low-alloyed	≤120 Bhn	230	•	•	•	•	0.010	0.012	0.016	0.020	0.020	0.025
Brass, short-chipping	≤200 Bhn	590	•	•	•	•	0.012	0.016	0.020	0.025	0.025	0.031
Brass, long-chipping	200-260 Bhn	395	•	•	•	•	0.010	0.012	0.016	0.020	0.020	0.025
Bronze, long-chipping	≤24 Bhn	230	•	•	•	•	0.010	0.012	0.016	0.020	0.020	0.025
	24-30 Bhn	165	•	•	•	•	0.010	0.012	0.016	0.020	0.020	0.025

Series # 4105/4106 body (1xD/1.5xD) with # 4115 insert

Material group	Hardness	SFM	Feed Rate - IPR									
			1/16 in. 1.590 mm	1/8 in. 3.170 mm	1/4 in. 6.350 mm	3/8 in. 9.520 mm	1/2 in. 12.700mm	5/8 in. 15.870mm	3/4 in. 19.050mm	1 in. 25.400mm	1 1/4 in. 31.75mm	1 1/2 in. 38.10mm
Stainless steels, sulphured	≤24 Rc	180	•	•	•	•	0.005	0.006	0.008	0.010	0.010	0.012
austenitic	≤24 Rc	130	•	•	•	•	0.005	0.006	0.008	0.010	0.010	0.012
martensitic	≤24 Rc	115	•	•	•	•	0.005	0.006	0.008	0.010	0.010	0.012
Hardened steels	40-48	80	•	•	•	•	0.004	0.005	0.006	0.008	0.008	0.010
	48-60	•	•	•	•	•	•	•	•	•	•	•
Special alloys	≤38	80	•	•	•	•	0.004	0.005	0.006	0.008	0.008	0.010
Chilled cast iron	<350 Bhn	295	•	•	•	•	0.010	0.012	0.016	0.020	0.020	0.025
Ti and Ti-alloys	≤24 Rc	130	•	•	•	•	0.005	0.006	0.008	0.010	0.010	0.012
	>24-38 Rc	115	•	•	•	•	0.004	0.005	0.006	0.008	0.008	0.010

Using These Tables. The Speeds & Feeds listed below are conservative recommendations for initial setup. In actual use, depending on the machining environment and workpiece material, significantly higher speeds and feeds may be achievable. Using the below as a starting point, cutting speed/feed can be gradually adjusted upwards until the optimum settings per application are found. Questions? Contact us by telephone at (800) 776-6170.

Series # 4107 body (3xD) with # 4112 insert

Material group	Hardness	SFM	Feed Rate - IPR										
			1/16 in. 1.590 mm	1/8 in. 3.170 mm	1/4 in. 6.350 mm	3/8 in. 9.520 mm	1/2 in. 12.700mm	5/8 in. 15.870mm	3/4 in. 19.050mm	1 in. 25.400mm	1 1/4 in. 31.75mm	1 1/2 in. 38.10mm	
Common structural steels	≤ 100 BHN	425	•	•	•	•	•	0.010	0.012	0.016	0.020	0.020	0.025
	100-260 BHN	360	•	•	•	•	•	0.008	0.010	0.012	0.016	0.016	0.020
Free-cutting steels	≤ 24 HRC	425	•	•	•	•	•	0.012	0.016	0.020	0.025	0.025	0.031
	24-30 HRC	360	•	•	•	•	•	0.010	0.012	0.016	0.020	0.020	0.025
Unalloyed heat-treatable steels	≤ 16 HRC	425	•	•	•	•	•	0.010	0.012	0.016	0.020	0.020	0.025
	16-24 HRC	410	•	•	•	•	•	0.010	0.012	0.016	0.020	0.020	0.025
	24-30 HRC	360	•	•	•	•	•	0.008	0.010	0.012	0.016	0.016	0.020
Alloyed heat-treatable steels	24-30 HRC	360	•	•	•	•	•	0.010	0.012	0.016	0.020	0.020	0.025
	30-38 HRC	295	•	•	•	•	•	0.008	0.010	0.012	0.016	0.016	0.020
Unalloyed case hardened steels	≤ 230 BHN	425	•	•	•	•	•	0.012	0.016	0.020	0.025	0.025	0.031
Alloyed case hardened steels	24-30 HRC	360	•	•	•	•	•	0.010	0.012	0.016	0.020	0.020	0.025
	30-38 HRC	230	•	•	•	•	•	0.006	0.008	0.010	0.012	0.012	0.016
Nitriding steels	24-30 HRC	345	•	•	•	•	•	0.008	0.010	0.012	0.016	0.016	0.020
	30-38 HRC	230	•	•	•	•	•	0.006	0.008	0.010	0.012	0.012	0.016
Tool steels	≤ 24 HRC	195	•	•	•	•	•	0.008	0.010	0.012	0.016	0.016	0.020
	24-30 HRC	180	•	•	•	•	•	0.006	0.008	0.010	0.012	0.012	0.016
High speed steels	14-30 HRC	180	•	•	•	•	•	0.005	0.006	0.008	0.010	0.010	0.012
Spring steels	≤ 330 BHN	165	•	•	•	•	•	0.004	0.005	0.006	0.008	0.008	0.010
Stainless steels	≤ 24 HRC	180	•	•	•	•	•	0.005	0.006	0.008	0.010	0.010	0.012
	≤ 24 HRC	130	•	•	•	•	•	0.005	0.006	0.008	0.010	0.010	0.012
	≤ 24 HRC	115	•	•	•	•	•	0.005	0.006	0.008	0.010	0.010	0.012
Hardened steels	40-48 HRC	80	•	•	•	•	•	0.004	0.005	0.006	0.008	0.008	0.010
	48-60 HRC	•	•	•	•	•	•	•	•	•	•	•	•
Special alloys	≤ 38 HRC	80	•	•	•	•	•	0.004	0.005	0.006	0.008	0.008	0.010
Ti and Ti-alloys	≤ 24 HRC	130	•	•	•	•	•	0.005	0.006	0.008	0.010	0.010	0.012
	24-38 HRC	115	•	•	•	•	•	0.004	0.005	0.006	0.008	0.008	0.010

Series # 4107 body (3xD) with # 4113 insert

Material group	Hardness	SFM	Feed Rate - IPR										
			1/16 in. 1.590 mm	1/8 in. 3.170 mm	1/4 in. 6.350 mm	3/8 in. 9.520 mm	1/2 in. 12.700 mm	5/8 in. 15.870 mm	3/4 in. 19.050 mm	1 in. 25.400 mm	1 1/4 in. 31.750 mm	1 1/2 in. 38.100 mm	
Cast iron	≤240 Bhn	330	•	•	•	•	•	0.010	0.012	0.016	0.020	0.020	0.025
	240-300 Bhn	295	•	•	•	•	•	0.010	0.012	0.016	0.020	0.020	0.025
New Cast Materials CGI & ADI	220-300 Bhn	260	•	•	•	•	•	0.008	0.010	0.012	0.016	0.016	0.020
New Cast Materials CGI & ADI	350-410 Bhn	260	•	•	•	•	•	0.008	0.010	0.012	0.016	0.016	0.020
Spheroidal graphite iron and malleable cast iron	≤240 Bhn	395	•	•	•	•	•	0.012	0.016	0.020	0.025	0.025	0.031
	240-300 Bhn	330	•	•	•	•	•	0.010	0.012	0.016	0.020	0.020	0.025

Series # 4107 body (3xD) with # 4114 insert

Material group	Hardness	SFM	Feed Rate - IPR										
			1/16 in. 1.590 mm	1/8 in. 3.170 mm	1/4 in. 6.350 mm	3/8 in. 9.520 mm	1/2 in. 12.700 mm	5/8 in. 15.870 mm	3/4 in. 19.050 mm	1 in. 25.400 mm	1 1/4 in. 31.750 mm	1 1/2 in. 38.100 mm	
Aluminium and Al-alloys	≤120 Bhn	655	•	•	•	•	•	0.012	0.016	0.020	0.025	0.025	0.031
Al wrought alloys	≤150 Bhn	590	•	•	•	•	•	0.012	0.016	0.020	0.025	0.025	0.031
Al cast alloys ≤ 10% Si	≤200 Bhn	490	•	•	•	•	•	0.012	0.016	0.020	0.025	0.025	0.031
	≤ 24% Si	395	•	•	•	•	•	0.012	0.016	0.020	0.025	0.025	0.031
Magnesium alloys	≤150 Bhn	590	•	•	•	•	•	0.012	0.016	0.020	0.025	0.025	0.031
Copper, low-alloyed	≤120 Bhn	230	•	•	•	•	•	0.010	0.012	0.016	0.020	0.020	0.025
Brass, short-chipping	≤200 Bhn	590	•	•	•	•	•	0.012	0.016	0.020	0.025	0.025	0.031
	long-chipping	≤200 Bhn	395	•	•	•	•	•	0.010	0.012	0.016	0.020	0.020
Bronze, short-chipping	≤200 Bhn	230	•	•	•	•	•	0.010	0.012	0.016	0.020	0.020	0.025
	>200-260 Bhn	165	•	•	•	•	•	0.010	0.012	0.016	0.020	0.020	0.025
Bronze, long-chipping	≤24 Hrc	150	•	•	•	•	•	0.010	0.012	0.016	0.020	0.020	0.025
	24-30 Hrc	115	•	•	•	•	•	0.008	0.010	0.012	0.016	0.016	0.020

Series # 4107 body (3xD) with # 4115 insert

Material group	Hardness	SFM	Feed Rate - IPR										
			1/16 in. 1.590 mm	1/8 in. 3.170 mm	1/4 in. 6.350 mm	3/8 in. 9.520 mm	1/2 in. 12.700 mm	5/8 in. 15.870 mm	3/4 in. 19.050 mm	1 in. 25.400 mm	1 1/4 in. 31.750 mm	1 1/2 in. 38.100 mm	
Stainless steels, sulphured austenitic martensitic	≤24 hrc	180	•	•	•	•	•	0.005	0.006	0.008	0.010	0.010	0.012
	≤24 hrc	130	•	•	•	•	•	0.005	0.006	0.008	0.010	0.010	0.012
	≤24 hrc	115	•	•	•	•	•	0.005	0.006	0.008	0.010	0.010	0.012
Hardened steels	>40-48 hrc	80	•	•	•	•	•	0.004	0.005	0.006	0.008	0.008	0.010
	>48-60 hrc	•	•	•	•	•	•	•	•	•	•	•	•
Special alloys	≤38 hrc	80	•	•	•	•	•	0.004	0.005	0.006	0.008	0.008	0.010
Chilled cast iron	≤350 Bhn	295	•	•	•	•	•	0.010	0.012	0.016	0.020	0.020	0.025
Ti and Ti-alloys	≤24 hrc	130	•	•	•	•	•	0.005	0.006	0.008	0.010	0.010	0.012
	>24-38 hrc	115	•	•	•	•	•	0.004	0.005	0.006	0.008	0.008	0.010

$$\text{RPM} = \frac{\text{SFM}}{\text{DIAM. in.}} \times 3.82 \quad \text{IPM} = \text{IPR} \times \text{RPM}$$

$$\frac{\text{HOLE DEPTH in.}}{\text{IPM}} \times 60 = \text{Cut Time}$$

$$\text{mm} = \text{in.} \times 25.40$$

$$\text{m/min.} = \text{SFM} \div 3.28$$

$$\text{mm/rev.} = \text{IPR} \times 25.40$$

$$\text{Bar} = \text{PSI} \div 14.50$$

$$\text{Liter} = \text{Gal.} \div 3.79$$

Series # 4108 body (5xD) with # 4112 insert

Material group	Hardness	SFM	Feed Rate - IPR											
			1/16 in. 1.590 mm	1/8 in. 3.170 mm	1/4 in. 6.350 mm	3/8 in. 9.520 mm	1/2 in. 12.700mm	5/8 in. 15.870mm	3/4 in. 19.050mm	1 in. 25.400mm	1 1/4 in. 31.75mm	1 1/2 in. 38.10mm		
Common structural steels	≤ 100 BHN	425	•	•	•	•	•	0.010	0.012	0.016	0.020	0.020	0.025	
	100-260 BHN	360	•	•	•	•	•	0.008	0.010	0.012	0.016	0.016	0.020	
Free-cutting steels	≤ 24 HRC	425	•	•	•	•	•	0.012	0.016	0.020	0.025	0.025	0.031	
	24-30 HRC	360	•	•	•	•	•	0.010	0.012	0.016	0.020	0.020	0.025	
Unalloyed heat-treatable steels	≤ 16 HRC	425	•	•	•	•	•	0.010	0.012	0.016	0.020	0.020	0.025	
	16-24 HRC	410	•	•	•	•	•	0.010	0.012	0.016	0.020	0.020	0.025	
	24-30 HRC	360	•	•	•	•	•	0.008	0.010	0.012	0.016	0.016	0.020	
Alloyed heat-treatable steels	24-30 HRC	360	•	•	•	•	•	0.010	0.012	0.016	0.020	0.020	0.025	
	30-38 HRC	295	•	•	•	•	•	0.008	0.010	0.012	0.016	0.016	0.020	
Unalloyed case hardened steels	≤ 230 BHN	425	•	•	•	•	•	0.012	0.016	0.020	0.025	0.025	0.031	
Alloyed case hardened steels	24-30 HRC	360	•	•	•	•	•	0.010	0.012	0.016	0.020	0.020	0.025	
	30-38 HRC	230	•	•	•	•	•	0.006	0.008	0.010	0.012	0.012	0.016	
Nitriding steels	24-30 HRC	345	•	•	•	•	•	0.008	0.010	0.012	0.016	0.016	0.020	
	30-38 HRC	230	•	•	•	•	•	0.006	0.008	0.010	0.012	0.012	0.016	
Tool steels	≤ 24 HRC	195	•	•	•	•	•	0.008	0.010	0.012	0.016	0.016	0.020	
	24-30 HRC	180	•	•	•	•	•	0.006	0.008	0.010	0.012	0.012	0.016	
High speed steels	14-30 HRC	180	•	•	•	•	•	0.005	0.006	0.008	0.010	0.010	0.012	
Spring steels	≤ 330 BHN	165	•	•	•	•	•	0.004	0.005	0.006	0.008	0.008	0.010	
Stainless steels	sulphured austenitic martensitic	≤ 24 HRC	180	•	•	•	•	•	0.005	0.006	0.008	0.010	0.010	0.012
		≤ 24 HRC	130	•	•	•	•	•	0.005	0.006	0.008	0.010	0.010	0.012
		≤ 24 HRC	115	•	•	•	•	•	0.005	0.006	0.008	0.010	0.010	0.012
Hardened steels	40-48 HRC	80	•	•	•	•	•	0.004	0.005	0.006	0.008	0.008	0.010	
	48-60 HRC	•	•	•	•	•	•	•	•	•	•	•	•	
Special alloys	≤ 38 HRC	80	•	•	•	•	•	0.004	0.005	0.006	0.008	0.008	0.010	
Ti and Ti-alloys	≤ 24 HRC	130	•	•	•	•	•	0.005	0.006	0.008	0.010	0.010	0.012	
	24-38 HRC	115	•	•	•	•	•	0.004	0.005	0.006	0.008	0.008	0.010	

Series # 4108 body (5xD) with # 4113 insert

Material group	Hardness	SFM	Feed Rate - IPR										
			1/16 in. 1.590 mm	1/8 in. 3.170 mm	1/4 in. 6.350 mm	3/8 in. 9.520 mm	1/2 in. 12.700 mm	5/8 in. 15.870 mm	3/4 in. 19.050 mm	1 in. 25.400 mm	1 1/4 in. 31.750 mm	1 1/2 in. 38.100 mm	
Cast iron	≤240 Bhn	330	•	•	•	•	•	0.010	0.012	0.016	0.020	0.020	0.025
	240-300 Bhn	295	•	•	•	•	•	0.010	0.012	0.016	0.020	0.020	0.025
New Cast Materials CGI & ADI	220-300 Bhn	260	•	•	•	•	•	0.008	0.010	0.012	0.016	0.016	0.020
New Cast Materials CGI & ADI	350-410 Bhn	260	•	•	•	•	•	0.008	0.010	0.012	0.016	0.016	0.020
Spheroidal graphite iron and malleable cast iron	≤240 Bhn	395	•	•	•	•	•	0.012	0.016	0.020	0.025	0.025	0.031
	240-300 Bhn	330	•	•	•	•	•	0.010	0.012	0.016	0.020	0.020	0.025

Series # 4108 body (5xD) with # 4114 insert

Material group	Hardness	SFM	Feed Rate - IPR										
			1/16 in. 1.590 mm	1/8 in. 3.170 mm	1/4 in. 6.350 mm	3/8 in. 9.520 mm	1/2 in. 12.700 mm	5/8 in. 15.870 mm	3/4 in. 19.050 mm	1 in. 25.400 mm	1 1/4 in. 31.750 mm	1 1/2 in. 38.100 mm	
Aluminium and Al-alloys	≤120 Bhn	655	•	•	•	•	•	0.012	0.016	0.020	0.025	0.025	0.031
Al wrought alloys	≤150 Bhn	590	•	•	•	•	•	0.012	0.016	0.020	0.025	0.025	0.031
Al cast alloys ≤ 10% Si	≤200 Bhn	490	•	•	•	•	•	0.012	0.016	0.020	0.025	0.025	0.031
	≤24% Si	395	•	•	•	•	•	0.012	0.016	0.020	0.025	0.025	0.031
Magnesium alloys	≤150 Bhn	590	•	•	•	•	•	0.012	0.016	0.020	0.025	0.025	0.031
Copper, low-alloyed	≤120 Bhn	230	•	•	•	•	•	0.010	0.012	0.016	0.020	0.020	0.025
Brass, short-chipping	≤200 Bhn	590	•	•	•	•	•	0.012	0.016	0.020	0.025	0.025	0.031
	long-chipping	≤200 Bhn	395	•	•	•	•	•	0.010	0.012	0.016	0.020	0.020
Bronze, short-chipping	≤200 Bhn	230	•	•	•	•	•	0.010	0.012	0.016	0.020	0.020	0.025
	>200-260 Bhn	165	•	•	•	•	•	0.010	0.012	0.016	0.020	0.020	0.025
Bronze, long-chipping	≤24 Rc	150	•	•	•	•	•	0.010	0.012	0.016	0.020	0.020	0.025
	24-30 Rc	115	•	•	•	•	•	0.008	0.010	0.012	0.016	0.016	0.020

Series # 4108 body (5xD) with # 4115 insert

Material group	Hardness	SFM	Feed Rate - IPR										
			1/16 in. 1.590 mm	1/8 in. 3.170 mm	1/4 in. 6.350 mm	3/8 in. 9.520 mm	1/2 in. 12.700 mm	5/8 in. 15.870 mm	3/4 in. 19.050 mm	1 in. 25.400 mm	1 1/4 in. 31.750 mm	1 1/2 in. 38.100 mm	
Stainless steels, sulphured	≤24 Rc	180	•	•	•	•	•	0.005	0.006	0.008	0.010	0.010	0.012
	≤24 Rc	130	•	•	•	•	•	0.005	0.006	0.008	0.010	0.010	0.012
	≤24 Rc	115	•	•	•	•	•	0.005	0.006	0.008	0.010	0.010	0.012
Hardened steels	40-48 Rc	80	•	•	•	•	•	0.004	0.005	0.006	0.008	0.008	0.010
	48-60 Rc	•	•	•	•	•	•	•	•	•	•	•	•
Special alloys	≤38 Rc	80	•	•	•	•	•	0.004	0.005	0.006	0.008	0.008	0.010
Chilled cast iron	≤350 Bhn	295	•	•	•	•	•	0.010	0.012	0.016	0.020	0.020	0.025
Ti and Ti-alloys	≤24 Rc	130	•	•	•	•	•	0.005	0.006	0.008	0.010	0.010	0.012
	>24-38 Rc	115	•	•	•	•	•	0.004	0.005	0.006	0.008	0.008	0.010

Using These Tables. The Speeds & Feeds listed below are conservative recommendations for initial setup. In actual use, depending on the machining environment and workpiece material, significantly higher speeds and feeds may be achievable. Using the below as a starting point, cutting speed/feed can be gradually adjusted upwards until the optimum settings per application are found. Questions? Contact us by telephone at (800) 776-6170.

Series # 4109 body (7xD) with # 4112 insert

Material group	Hardness	SFM	Feed Rate - IPR										
			1/16 in. 1.590 mm	1/8 in. 3.170 mm	1/4 in. 6.350 mm	3/8 in. 9.520 mm	1/2 in. 12.700mm	5/8 in. 15.870mm	3/4 in. 19.050mm	1 in. 25.400mm	1 1/4 in. 31.75mm	1 1/2 in. 38.10mm	
Common structural steels	≤ 100 BHN	425	•	•	•	•	•	0.008	0.010	0.012	0.016	0.016	0.020
	100-260 BHN	360	•	•	•	•	•	0.006	0.008	0.010	0.012	0.012	0.016
Free-cutting steels	≤ 24 HRC	425	•	•	•	•	•	0.010	0.012	0.016	0.020	0.020	0.025
	24-30 HRC	360	•	•	•	•	•	0.008	0.010	0.012	0.016	0.016	0.020
Unalloyed heat-treatable steels	≤ 16 HRC	425	•	•	•	•	•	0.008	0.010	0.012	0.016	0.016	0.020
	16-24 HRC	410	•	•	•	•	•	0.008	0.010	0.012	0.016	0.016	0.020
	24-30 HRC	360	•	•	•	•	•	0.006	0.008	0.010	0.012	0.012	0.016
Alloyed heat-treatable steels	24-30 HRC	360	•	•	•	•	•	0.008	0.010	0.012	0.016	0.016	0.020
	30-38 HRC	295	•	•	•	•	•	0.006	0.008	0.010	0.012	0.012	0.016
Unalloyed case hardened steels	≤ 230 BHN	425	•	•	•	•	•	0.010	0.012	0.016	0.020	0.020	0.025
Alloyed case hardened steels	24-30 HRC	360	•	•	•	•	•	0.008	0.010	0.012	0.016	0.016	0.020
	30-38 HRC	230	•	•	•	•	•	0.006	0.008	0.010	0.012	0.012	0.016
Nitriding steels	24-30 HRC	345	•	•	•	•	•	0.006	0.008	0.010	0.012	0.012	0.016
	30-38 HRC	230	•	•	•	•	•	0.005	0.006	0.008	0.010	0.010	0.012
Tool steels	≤ 24 HRC	195	•	•	•	•	•	0.006	0.008	0.010	0.012	0.012	0.016
	24-30 HRC	180	•	•	•	•	•	0.005	0.006	0.008	0.010	0.010	0.012
High speed steels	14-30 HRC	180	•	•	•	•	•	0.004	0.005	0.006	0.008	0.008	0.010
Spring steels	≤ 330 BHN	165	•	•	•	•	•	0.004	0.005	0.006	0.008	0.008	0.010
Stainless steels	≤ 24 HRC	180	•	•	•	•	•	0.004	0.005	0.006	0.008	0.008	0.010
	≤ 24 HRC	130	•	•	•	•	•	0.004	0.005	0.006	0.008	0.008	0.010
	≤ 24 HRC	115	•	•	•	•	•	0.004	0.005	0.006	0.008	0.008	0.010
Hardened steels	40-48 HRC	80	•	•	•	•	•	0.003	0.004	0.005	0.006	0.006	0.008
	48-60 HRC	•	•	•	•	•	•	•	•	•	•	•	•
Special alloys	≤ 38 HRC	80	•	•	•	•	•	0.003	0.004	0.005	0.006	0.006	0.008
Ti and Ti-alloys	≤ 24 HRC	130	•	•	•	•	•	0.004	0.005	0.006	0.008	0.008	0.010
	24-38 HRC	115	•	•	•	•	•	0.003	0.004	0.005	0.006	0.006	0.008

Series # 4109 body (7xD) with # 4113 insert

Material group	Hardness	SFM	Feed Rate - IPR										
			1/16 in. 1.590 mm	1/8 in. 3.170 mm	1/4 in. 6.350 mm	3/8 in. 9.520 mm	1/2 in. 12.700 mm	5/8 in. 15.870 mm	3/4 in. 19.050 mm	1 in. 25.400 mm	1 1/4 in. 31.750 mm	1 1/2 in. 38.100 mm	
Cast iron	≤240 Bhn	330	•	•	•	•	•	0.010	0.012	0.016	0.020	0.020	0.025
	240-300 Bhn	295	•	•	•	•	•	0.010	0.012	0.016	0.020	0.020	0.025
New Cast Materials CGI & ADI	240-300 Bhn	260	•	•	•	•	•	0.008	0.010	0.012	0.016	0.016	0.020
New Cast Materials CGI & ADI	350-410 Bhn	260	•	•	•	•	•	0.008	0.010	0.012	0.016	0.016	0.020
Spheroidal graphite iron and malleable cast iron	≤240 Bhn	395	•	•	•	•	•	0.012	0.016	0.020	0.025	0.025	0.031
	240-300 Bhn	330	•	•	•	•	•	0.010	0.012	0.016	0.020	0.020	0.025

Series # 4109 body (7xD) with # 4114 insert

Material group	Hardness	SFM	Feed Rate - IPR										
			1/16 in. 1.590 mm	1/8 in. 3.170 mm	1/4 in. 6.350 mm	3/8 in. 9.520 mm	1/2 in. 12.700 mm	5/8 in. 15.870 mm	3/4 in. 19.050 mm	1 in. 25.400 mm	1 1/4 in. 31.750 mm	1 1/2 in. 38.100 mm	
Aluminium and Al-alloys	≤120 Bhn	655	•	•	•	•	•	0.010	0.012	0.016	0.020	0.020	0.025
Al wrought alloys	≤150 Bhn	590	•	•	•	•	•	0.010	0.012	0.016	0.020	0.020	0.025
Al cast alloys ≤ 10% Si	≤200 Bhn	490	•	•	•	•	•	0.010	0.012	0.016	0.020	0.020	0.025
	≤200 Bhn	395	•	•	•	•	•	0.010	0.012	0.016	0.020	0.020	0.025
Magnesium alloys	≤150 Bhn	590	•	•	•	•	•	0.010	0.012	0.016	0.020	0.020	0.025
Copper, low-alloyed	≤120 Bhn	230	•	•	•	•	•	0.008	0.010	0.012	0.016	0.016	0.020
Brass, short-chipping	≤200 Bhn	590	•	•	•	•	•	0.010	0.012	0.016	0.020	0.020	0.025
	≤200 Bhn	395	•	•	•	•	•	0.008	0.010	0.012	0.016	0.016	0.020
Bronze, short-chipping	≤200 Bhn	230	•	•	•	•	•	0.008	0.010	0.012	0.016	0.016	0.020
	200-260 Bhn	165	•	•	•	•	•	0.008	0.010	0.012	0.016	0.016	0.020
Bronze, long-chipping	24 Hrc	150	•	•	•	•	•	0.008	0.010	0.012	0.016	0.016	0.020
	24-30 Hrc	115	•	•	•	•	•	0.006	0.008	0.010	0.012	0.012	0.016

Series # 4109 body (7xD) with # 4115 insert

Material group	Hardness	SFM	Feed Rate - IPR										
			1/16 in. 1.590 mm	1/8 in. 3.170 mm	1/4 in. 6.350 mm	3/8 in. 9.520 mm	1/2 in. 12.700 mm	5/8 in. 15.870 mm	3/4 in. 19.050 mm	1 in. 25.400 mm	1 1/4 in. 31.750 mm	1 1/2 in. 38.100 mm	
Stainless steels, sulphured austenitic martensitic	≤24 Hrc	180	•	•	•	•	•	0.004	0.005	0.006	0.008	0.008	0.010
	≤24 Hrc	130	•	•	•	•	•	0.004	0.005	0.006	0.008	0.008	0.010
	≤24 Hrc	115	•	•	•	•	•	0.004	0.005	0.006	0.008	0.008	0.010
Hardened steels	40-48 Hrc	80	•	•	•	•	•	0.003	0.004	0.005	0.006	0.006	0.008
	48-60 Hrc	•	•	•	•	•	•	•	•	•	•	•	•
Special alloys	≤38 Hrc	80	•	•	•	•	•	0.003	0.004	0.005	0.006	0.006	0.008
Chilled cast iron	≤350 Bhn	295	•	•	•	•	•	0.010	0.012	0.016	0.020	0.020	0.025
Ti and Ti-alloys	≤24 Hrc	130	•	•	•	•	•	0.004	0.005	0.006	0.008	0.008	0.010
	24-38 Hrc	115	•	•	•	•	•	0.003	0.004	0.005	0.006	0.006	0.008

$$\text{RPM} = \frac{\text{SFM}}{\text{DIAM. in.}} \times 3.82 \quad \text{IPM} = \text{IPR} \times \text{RPM}$$

$$\frac{\text{HOLE DEPTH in.}}{\text{IPM}} \times 60 = \text{Cut Time}$$

$$\text{mm} = \text{in.} \times 25.40$$

$$\text{m/min.} = \text{SFM} \div 3.28$$

$$\text{mm/rev.} = \text{IPR} \div 25.40$$

$$\text{Bar} = \text{PSI} \div 14.50$$

$$\text{Liter} = \text{Gal.} \div 3.79$$

Series # 4110 body (10xD) with # 4112 insert

Material group	Hardness	SFM	Feed Rate - IPR										
			1/16 in. 1.590 mm	1/8 in. 3.170 mm	1/4 in. 6.350 mm	3/8 in. 9.520 mm	1/2 in. 12.700mm	5/8 in. 15.870mm	3/4 in. 19.050mm	1 in. 25.400mm	1 1/4 in. 31.75mm	1 1/2 in. 38.10mm	
Common structural steels	≤ 100 BHN	425	•	•	•	•	0.008	0.010	0.010	0.016	0.016	0.020	
	100-260 BHN	360	•	•	•	•	0.006	0.008	0.012	0.012	0.012	0.016	
Free-cutting steels	≤ 24 HRC	425	•	•	•	•	0.010	0.012	0.016	0.020	0.020	0.025	
	24-30 HRC	360	•	•	•	•	0.008	0.010	0.012	0.016	0.016	0.020	
Unalloyed heat-treatable steels	≤ 16 HRC	425	•	•	•	•	0.008	0.010	0.012	0.016	0.016	0.020	
	16-24 HRC	410	•	•	•	•	0.008	0.010	0.012	0.016	0.016	0.020	
	24-30 HRC	360	•	•	•	•	0.006	0.008	0.010	0.012	0.012	0.016	
Alloyed heat-treatable steels	24-30 HRC	360	•	•	•	•	0.008	0.010	0.012	0.016	0.016	0.020	
	30-38 HRC	295	•	•	•	•	0.006	0.008	0.010	0.012	0.012	0.016	
Unalloyed case hardened steels	≤ 230 BHN	425	•	•	•	•	0.010	0.012	0.016	0.020	0.020	0.025	
Alloyed case hardened steels	24-30 HRC	360	•	•	•	•	0.008	0.010	0.012	0.016	0.016	0.020	
	30-38 HRC	230	•	•	•	•	0.006	0.008	0.010	0.012	0.012	0.016	
Nitriding steels	24-30 HRC	345	•	•	•	•	0.006	0.008	0.010	0.012	0.012	0.016	
	30-38 HRC	230	•	•	•	•	0.005	0.006	0.008	0.010	0.010	0.012	
Tool steels	≤ 24 HRC	195	•	•	•	•	0.006	0.008	0.010	0.012	0.012	0.016	
	24-30 HRC	180	•	•	•	•	0.005	0.006	0.008	0.010	0.010	0.012	
High speed steels	14-30 HRC	180	•	•	•	•	0.004	0.005	0.006	0.008	0.008	0.010	
Spring steels	≤ 330 BHN	165	•	•	•	•	0.004	0.005	0.006	0.008	0.008	0.010	
Stainless steels	sulphured austenitic martensitic	≤ 24 HRC	180	•	•	•	•	0.004	0.005	0.006	0.008	0.008	0.010
		24 HRC	130	•	•	•	•	0.004	0.005	0.006	0.008	0.008	0.010
		24 HRC	115	•	•	•	•	0.004	0.005	0.006	0.008	0.008	0.010
Hardened steels	40-48 HRC	80	•	•	•	•	0.003	0.004	0.005	0.006	0.006	0.008	
	48-60 HRC	•	•	•	•	•	•	•	•	•	•	•	
Special alloys	≤ 38 HRC	80	•	•	•	•	0.003	0.004	0.005	0.006	0.006	0.008	
Ti and Ti-alloys	≤ 24 HRC	130	•	•	•	•	0.004	0.005	0.006	0.008	0.008	0.010	
	24-38 HRC	115	•	•	•	•	0.003	0.004	0.005	0.006	0.006	0.008	

Series # 4110 body (10xD) with # 4113 insert

Material group	Hardness	SFM	Feed Rate - IPR									
			1/16 in. 1.590 mm	1/8 in. 3.170 mm	1/4 in. 6.350 mm	3/8 in. 9.520 mm	1/2 in. 12.700 mm	5/8 in. 15.870 mm	3/4 in. 19.050 mm	1 in. 25.400 mm	1 1/4 in. 31.750 mm	1 1/2 in. 38.100 mm
Cast iron	≤240 Bhn	330	•	•	•	•	0.010	0.012	0.016	0.020	0.020	0.025
	240-300 Bhn	295	•	•	•	•	0.010	0.012	0.016	0.020	0.020	0.025
New Cast Materials CGI & ADI	220-300 Bhn	260	•	•	•	•	0.008	0.010	0.012	0.016	0.016	0.020
New Cast Materials CGI & ADI	350-410 Bhn	260	•	•	•	•	0.008	0.010	0.012	0.016	0.016	0.020
Spheroidal graphite iron and malleable cast iron	≤240 Bhn	395	•	•	•	•	0.012	0.016	0.020	0.025	0.025	0.031
	240-300 Bhn	330	•	•	•	•	0.010	0.012	0.016	0.020	0.020	0.025

Series # 4110 body (10xD) with # 4114 insert

Material group	Hardness	SFM	Feed Rate - IPR									
			1/16 in. 1.590 mm	1/8 in. 3.170 mm	1/4 in. 6.350 mm	3/8 in. 9.520 mm	1/2 in. 12.700 mm	5/8 in. 15.870 mm	3/4 in. 19.050 mm	1 in. 25.400 mm	1 1/4 in. 31.750 mm	1 1/2 in. 38.100 mm
Aluminium and Al-alloys	≤120 Bhn	655	•	•	•	•	0.010	0.012	0.016	0.020	0.020	0.025
Al wrought alloys	≤150 Bhn	590	•	•	•	•	0.010	0.012	0.016	0.020	0.020	0.025
Al cast alloys ≤ 10% Si	≤200 Bhn	490	•	•	•	•	0.010	0.012	0.016	0.020	0.020	0.025
	≤ 24% Si	395	•	•	•	•	0.010	0.012	0.016	0.020	0.020	0.025
Magnesium alloys	≤150 Bhn	590	•	•	•	•	0.010	0.012	0.016	0.020	0.020	0.025
Copper, low-alloyed	≤120 Bhn	230	•	•	•	•	0.008	0.010	0.012	0.016	0.016	0.020
Brass, short-chipping	≤200 Bhn	590	•	•	•	•	0.010	0.012	0.016	0.020	0.020	0.025
	≤200 Bhn	395	•	•	•	•	0.008	0.010	0.012	0.016	0.016	0.020
Bronze, short-chipping	≤200 Bhn	230	•	•	•	•	0.008	0.010	0.012	0.016	0.016	0.020
	200-260 Bhn	165	•	•	•	•	0.008	0.010	0.012	0.016	0.016	0.020
Bronze, long-chipping	≤24 Hrc	150	•	•	•	•	0.008	0.010	0.012	0.016	0.016	0.020
	24-30 Hrc	115	•	•	•	•	0.006	0.008	0.010	0.012	0.012	0.016

Series # 4110 body (10xD) with # 4115 insert

Material group	Hardness	SFM	Feed Rate - IPR									
			1/16 in. 1.590 mm	1/8 in. 3.170 mm	1/4 in. 6.350 mm	3/8 in. 9.520 mm	1/2 in. 12.700 mm	5/8 in. 15.870 mm	3/4 in. 19.050 mm	1 in. 25.400 mm	1 1/4 in. 31.750 mm	1 1/2 in. 38.100 mm
Stainless steels, sulphured austenitic martensitic	≤24 Hrc	180	•	•	•	•	0.004	0.005	0.006	0.008	0.008	0.010
	≤24 Hrc	130	•	•	•	•	0.004	0.005	0.006	0.008	0.008	0.010
	≤24 Hrc	115	•	•	•	•	0.004	0.005	0.006	0.008	0.008	0.010
Hardened steels	40-48 Hrc	80	•	•	•	•	0.003	0.004	0.005	0.006	0.006	0.008
	48-60 Hrc	•	•	•	•	•	•	•	•	•	•	•
Special alloys	≤38 Hrc	80	•	•	•	•	0.003	0.004	0.005	0.006	0.006	0.008
Chilled cast iron	≤350 Bhn	295	•	•	•	•	0.010	0.012	0.016	0.020	0.020	0.025
Ti and Ti-alloys	≤24 Rc	130	•	•	•	•	0.004	0.005	0.006	0.008	0.008	0.010
	24-38 Rc	115	•	•	•	•	0.003	0.004	0.005	0.006	0.006	0.008

Surface Refining Processes, Coatings For HT 800 WP Interchangeable Inserts

FIREX®/nanoFIREX®

Coating color: violet

This TiAlN/TiN multi-layer coating is applied to HSS and carbide drills. It offers outstanding heat and wear resistance in drilling applications, and is an excellent general purpose coating.

nanoA™

Coating color: grey-violet

Multi-layer coating that combines TiAlN and AlTiN coatings in a micro-layer structure that is harder and more wear resistant. This coating achieves optimal results when machining stainless steels.

TiAlN

Coating color: violet

The mono-layer TiAlN coating is suited for abrasive operations with carbide tools because of its high hardness and chemical resistance, e.g. hard machining and high speed cutting (HSC).

nano-Si™

Coating color: bronze

HT800 inserts can be modified by adding our nano-Si coating for prolonged tool life in nickel alloys, hardened steels, and abrasive materials.

Zenit

Coating color: light golden

The series 4114 HT800 insert can be modified by adding our Zenit coating for prolonged tool life when drilling in titanium and aluminum alloys. Zenit coating prevents built-up-edge from occurring in these materials.

bright

Within the HT800 offering, Guhring recommends our bright finish inserts for the machining of aluminum alloys. The highly polished surfaces helps prevent material build-up during the drilling process.

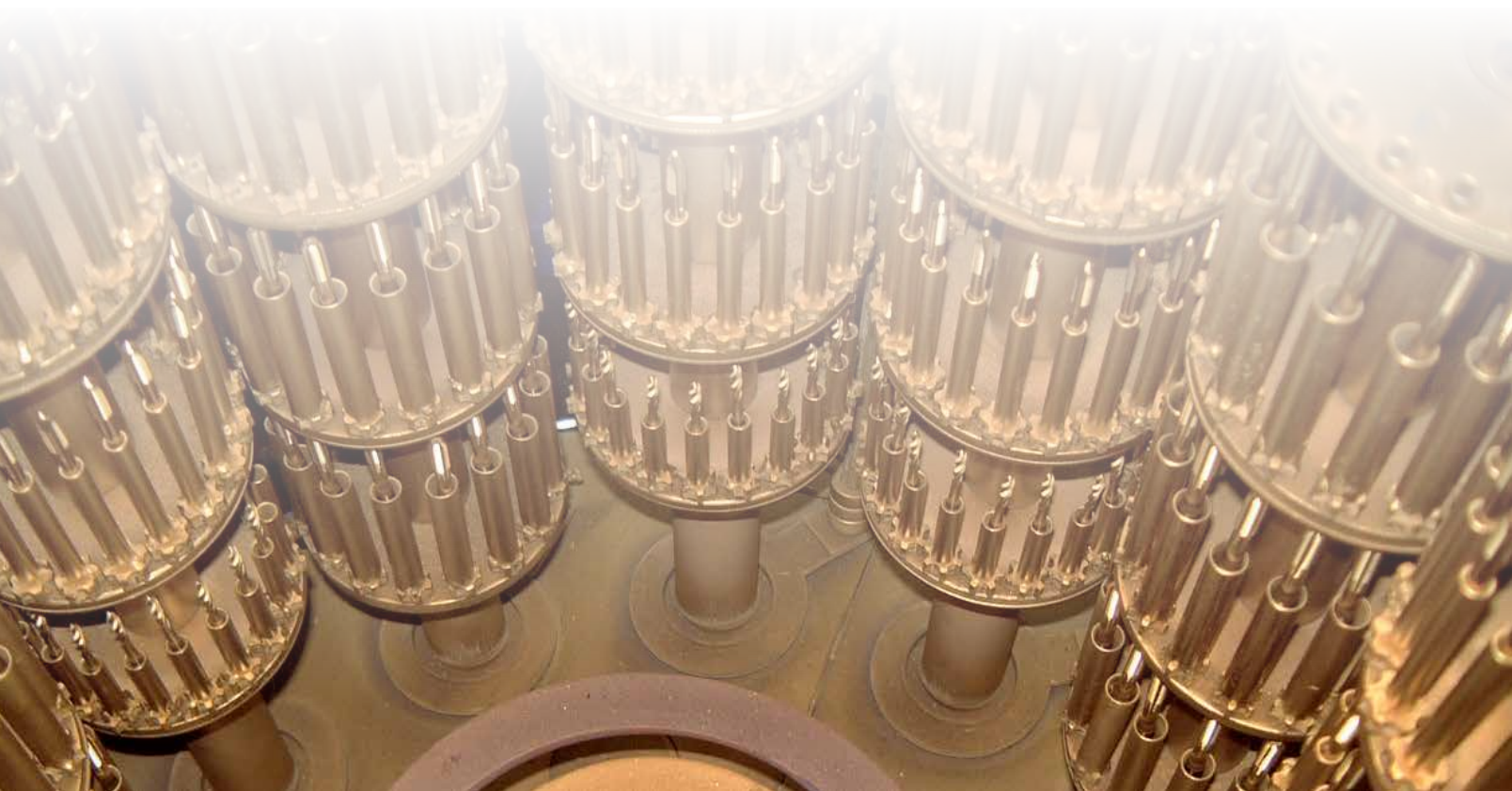

HT 800 WP Special Solutions

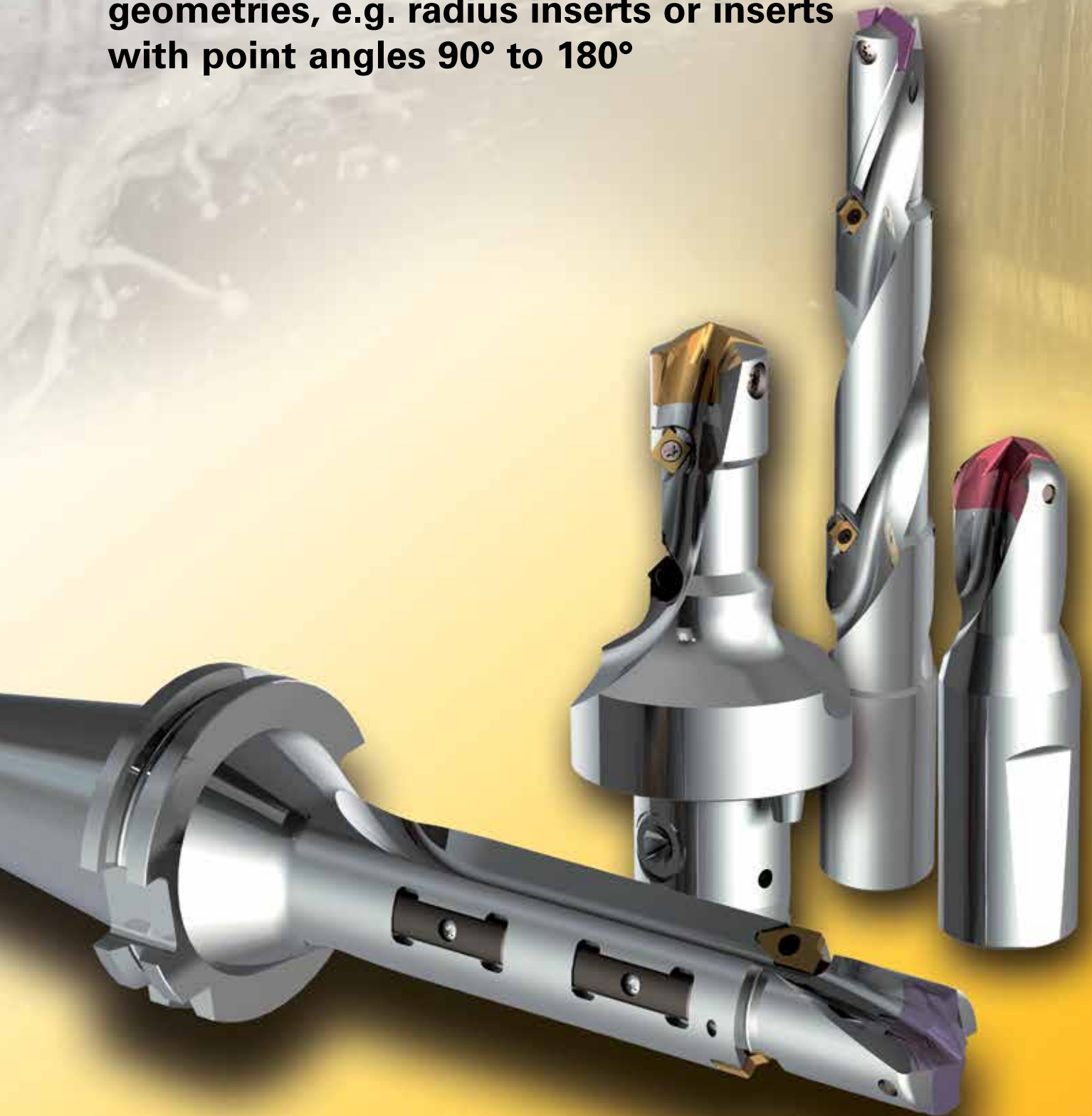

- stepped holders
- special clamping chucks
- inserts with special coatings and geometries, e.g. radius inserts or inserts with point angles 90° to 180°

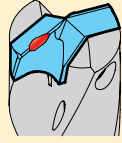
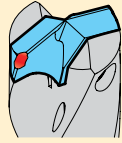
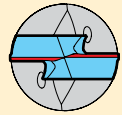
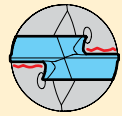
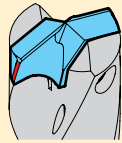
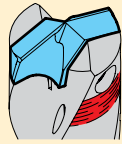

12 tips to help diagnose problems

Problem	Cause	Remedy
1 Cutting edge build up 	<ul style="list-style-type: none"> ■ low cutting speed ■ excessive honing of cutting lip ■ bright finish cutting lip 	<ul style="list-style-type: none"> ■ increase cutting speed ■ reduce cutting lip honing ■ have tool coated
2 Crumbling of outer corners 	<ul style="list-style-type: none"> ■ non rigid conditions, insufficient workpiece clamping ■ deviation from concentricity too large ■ interrupted cut 	<ul style="list-style-type: none"> ■ rigid clamping of workpiece ■ check and correct concentricity if possible ■ reduce feed
3 Heavy wear at flank 	<ul style="list-style-type: none"> ■ cutting speed too high ■ feed too low ■ clearance angle too small 	<ul style="list-style-type: none"> ■ reduce cutting speed ■ increase feed ■ increase clearance angle
4 Crumbling on cutting lips 	<ul style="list-style-type: none"> ■ non rigid conditions, insufficient workpiece clamping ■ interrupted cut ■ max. wear values exceeded ■ incorrect tool type 	<ul style="list-style-type: none"> ■ rigid clamping of workpiece ■ reduce feed ■ reduce tool change intervals ■ apply suitable tool
5 Land wear 	<ul style="list-style-type: none"> ■ non rigid conditions, insufficient workpiece clamping ■ deviation from concentricity too large ■ back taper too small ■ incorrect coolant (oil), coolant too weak 	<ul style="list-style-type: none"> ■ rigid clamping of workpiece ■ check and correct concentricity if possible ■ increase back taper ■ increase strength of coolant or use neat oil
6 Scoring on tool body 	<ul style="list-style-type: none"> ■ non rigid conditions, insufficient workpiece clamping ■ deviation from concentricity too large ■ interrupted cut ■ abrasive workpiece material 	<ul style="list-style-type: none"> ■ rigid clamping of workpiece ■ check and correct concentricity if possible ■ reduce feed ■ increase strength of coolant or use neat oil

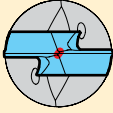
12 tips to help diagnose problems

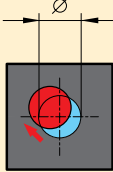
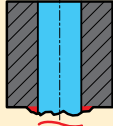
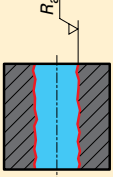
Problem	Cause	Remedy
7 Heavy chisel edge wear 	<ul style="list-style-type: none"> ■ cutting speed too low ■ feed too high ■ excessive honing of cutting lip 	<ul style="list-style-type: none"> ■ increase cutting speed ■ reduce feed ■ reduce cutting lip honing
8 Crumbling at intersection, web thinning and cutting lip 	<ul style="list-style-type: none"> ■ clearance angle too small ■ excessive honing of cutting lip ■ incorrect tool type 	<ul style="list-style-type: none"> ■ increase clearance angle ■ reduce cutting lip honing ■ apply suitable tool
9 Plastic deformation of outer corner 	<ul style="list-style-type: none"> ■ cutting speed too high ■ insufficient coolant volume ■ incorrect or no honing at corner 	<ul style="list-style-type: none"> ■ reduce cutting speed ■ increase volume/pressure ■ correct honing
10 Misalignment 	<ul style="list-style-type: none"> ■ non rigid conditions, insufficient workpiece clamping ■ deviation from concentricity too large ■ spotting area transverse ■ chisel edge too large 	<ul style="list-style-type: none"> ■ rigid clamping of workpiece ■ check and correct concentricity if possible ■ use milling cutter (2-fluted) for spotting ■ reduce chisel edge
11 Heavy burring on break-through 	<ul style="list-style-type: none"> ■ feed too high ■ max. wear values exceeded ■ excessive honing of cutting lip 	<ul style="list-style-type: none"> ■ reduce feed ■ reduce tool change intervals ■ reduce cutting lip honing
12 Unsatisfactory surface quality 	<ul style="list-style-type: none"> ■ non rigid conditions, insufficient workpiece clamping ■ deviation from concentricity too large ■ insufficient coolant volume 	<ul style="list-style-type: none"> ■ rigid clamping of workpiece ■ check and correct concentricity if possible ■ increase volume/pressure

GUHRING

The Tool Company

DRILLING

TAPPING/THREADMILLING/
FLUTELESS TAPPING

MILLING

REAMING

PCD/PCBN



SPECIAL TOOLING
SOLUTIONS

COUNTERSINKING/
DE-BURRING

MODULAR TOOLING
SYSTEMS

TOOL RECONDITIONING SERVICE

Guhring, Inc. Main Office
P.O. Box 643, Brookfield, WI 53008-0643
Shipping Address
1445 Commerce Avenue
Brookfield, WI 53045
Tel (262) 784-6730 (800) 776-6170
Fax (262) 784-9096

**West Coast Distribution Center and
Reconditioning Facility**
15581 Computer Ln
Huntington Beach, CA 92649
Reconditioning Facility
121 W Dudley Town Rd.
Bloomfield, CT 06002

**Manufacturing and
Reconditioning Facility**
29550 W.K. Smith Rd. Suite B
New Hudson, MI 48165

Guhring Corporation
20 Steckle Place, Unit #14
Kitchener, ON N2E 2C3
Tel (519) 748-9664 (800) 463-5555
Fax (519) 748-2954