

309

KAISER

PRECISION MODULAR TOOLING SYSTEM

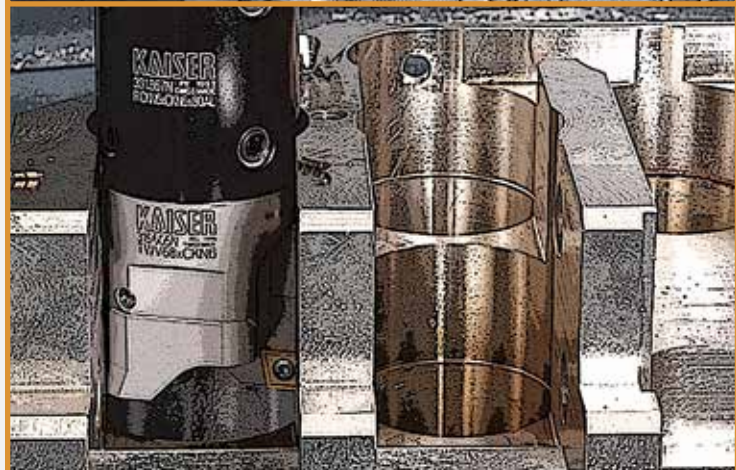
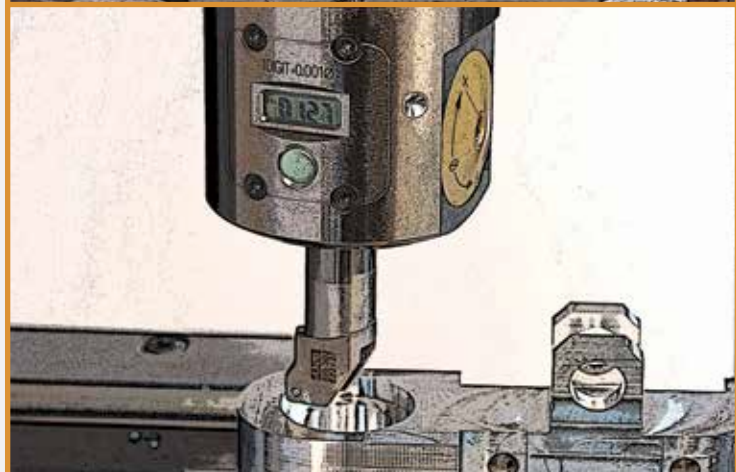
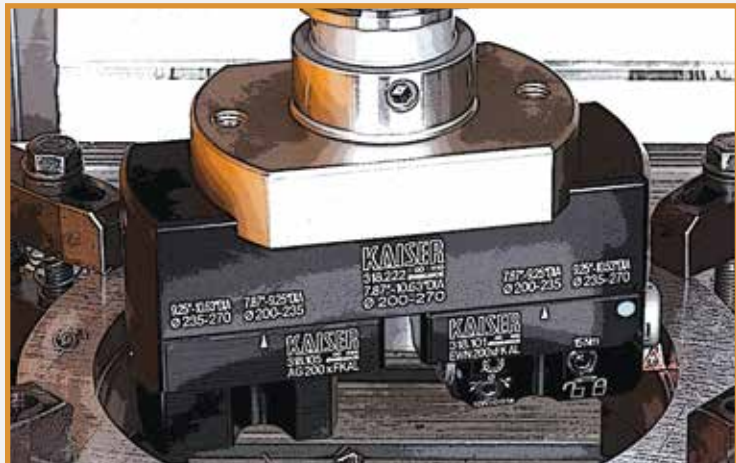

A PRODUCT OF:



























BIG KAISER[®]
PRECISION TOOLING INC.

Higher Performance. Guaranteed.

OVER 60 YEARS OF PRECISION

KAISER



	KA/KAB/KAD/BIG-PLUS® OVERVIEW, SHANKS, REDUCTIONS & EXTENSIONS, CARBIDE & HEAVY METAL BARSPg. 4-20	
	CKN OVERVIEW, SHANKS, REDUCTIONS, EXTENSIONS & COOLANT INDUCERSPg. 21-24	
	INDEXABLE INSERT DRILLS & SPADE DRILLSPg. 25-37	
	ROUGH BORING TOOLS ø.787"-8.000"Pg. 38-51	
	SMALL DIAMETER FINISH BORING TOOLS ø.016"-2.126"Pg. 52-73	
	MEDIUM DIAMETER FINISH BORING TOOLS ø.590"-8.000"Pg. 74-87	
	LARGE DIAMETER BORING SYSTEMS ø7.76"-118.15"Pg. 88-103	
	O.D. TURNING SYSTEMS ø.039"-112.441"Pg. 104-110	
	MILLING TOOLS, CHAMFERING TOOLS & SPECIAL TOOLSPg. 111-117	
	KAB MODULAR TOOL HOLDERS FOR MILLING, DRILLING, TAPPING & GROOVINGPg. 118-127	
	INDEXABLE INSERTS & SELECTION GUIDEPg. 128-135	
	TOOL PRESETTERS & TOOLING ACCESSORIESPg. 136-137	
	WEIGHTSPg. 138-151	

KA/KAB MODULAR TOOL SYSTEM OVERVIEW



The KAISER KA connection consists of a cylindrical male pilot ① and female receptacle ②. The connection is made by means of a radial locking screw ③ with a 15 degree taper. The screw engages in the respective offset pocket of the male pilot with a cam action.

The locking screw force (F_r) creates a 3.3 to 3.5 times larger axial force which rigidly clamps the faces of the two components together. This face-to-face clamping builds up a friction force between the two components. Additionally, the thrust (F_r) of the screw locks and pushes the male pilot securely into line contact against the opposite wall of the female connection.

The torsional cutting forces are primarily transmitted by the friction between the faces. Any remaining torque results in additional wedge action between the locking screw and the male member, which is transformed into a very strong additional axial clamping force (F_a).

There are many advantages to this simple but effective design:

- A.** Maximum rigidity due to the very strong face-to-face clamping forces over the full cross section of the modular connections. This allows stacking up to five components without detrimental effects.
- B.** Repeatable seating precision of the modular components of .0001" radial, due to radial line contact clamping.
- C.** 90° offset location of the locking screws to cutting edge guarantees spindle orientation irrespective of the number of components assembled.
- D.** Moderate vibration dampening effect due to the friction created between the mating components.
- E.** The components do not jam up. The simple design makes it easy to keep clean, assemble and disassemble without the need for special wrenches, fixtures and vises.

The KAISER KAB connection is derived from the KA connection without loss of all technical and dimensional features or interchangeability and ease of maintenance.

The KAB connection is equipped with a floating drive pin ④ which engages on both sides into respective pockets in the mating part. The tapers on the pins and the angles on the pockets are engineered to permit an automatic balancing of the two resulting torsional forces.

The drive pin is retained with a simple spring ring. Adaptation to the KA connection is made by pushing the drive pin out of the male pilot.

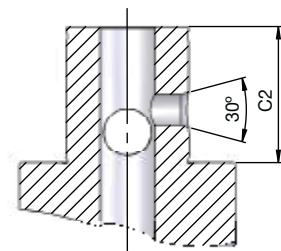
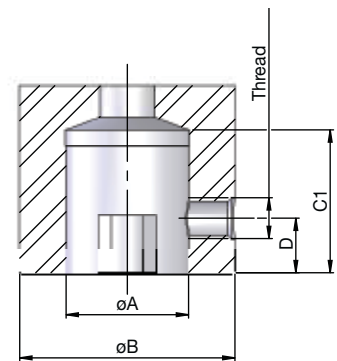
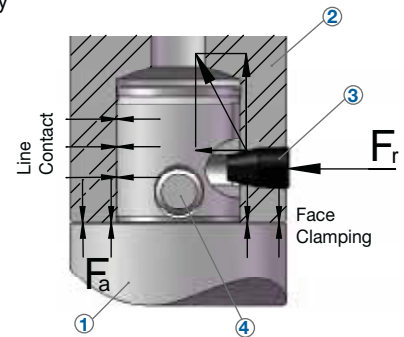
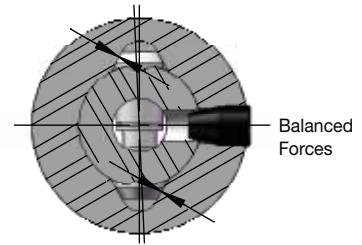

KA Locking Screws ③

Catalog Number	Adapter Size	Wrench	Hex Size	Torque (ft.-lbs.)
10.690.431	KA1	10.690.811	2	1.8
10.690.432	KA2	10.690.812	2.5	2.2
10.690.433	KA3	10.690.813	3	3.8
10.690.434	KA4	10.690.814	4	7.1
10.690.435	KA5	10.690.816	5	15
10.690.436	KA6	10.690.817	6	29
10.690.437	KA7	10.690.808	10	73

Drive Pin ④

Catalog Number	Adapter Size
10.691.501	KA1
10.691.502	KA2
10.691.503	KA3
10.691.504	KA4
10.691.505	KA5
10.691.506	KA6
10.691.507	KA7

Dimensions

Adapter Size	ϕA	ϕB	C1	C2	D	Thread
KA1	.433	.748	.551	.512	.199	M4x.5
KA2	.551	.945	.689	.630	.258	M5x.5
KA3	.709	1.220	.866	.787	.317	M6x.75
KA4	.866	1.535	1.024	.945	.396	M8x.75
KA5	1.102	1.969	1.260	1.181	.514	M10x1.0
KA6	1.417	2.490	1.654	1.575	.632	M12x1.0
KA7	1.811	3.543	2.047	1.968	.750	M20x1.5

The KAD modular tool and clamping system meets the requirements for high performance under all conditions, as well as the demand for optional versatility.

Through systematic development combined with countless practical tests, the well known KAB system can be easily upgraded to cope with the requirements of today's high performance tools. Designed with the need for complete compatibility of existing KAB tools, and for the highest possible rigidity, key components have been redesigned to include an axial tension screw (drawbolt) for heavy duty milling.

KAD compatible components include shanks, reductions, extensions, and tool holders which are ready to be equipped with drawbolts and threaded bushings. Clamping of the system components with the drawbolt is required only for extreme cutting conditions. Therefore, the KAD compatible components are supplied without drawbolts and threaded bushings, and must be ordered separately and assembled by the user.

Tightening the drawbolt generates an enormous preloading force which amplifies the face-to-face clamping forces of corresponding components. This results in an extremely rigid tool connection, making the tool better suited to meet the demands of modern milling operations.

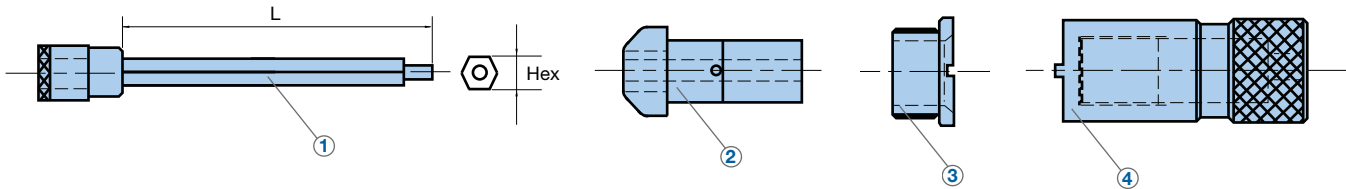
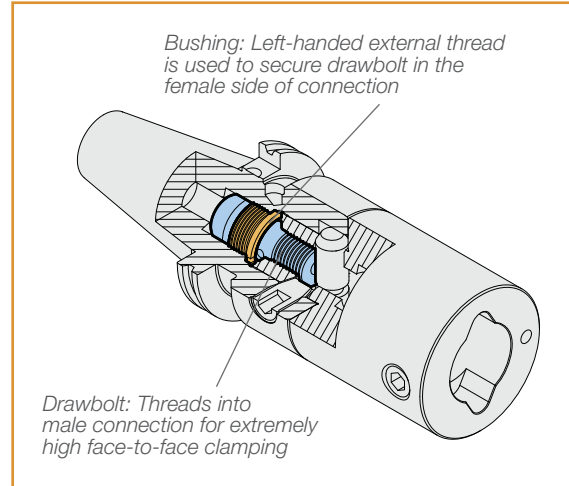

KAD Components

KAD Component	KAD Size	① Drawbolt Wrench	Hex Size	L	② Drawbolt	Thread	Torque (ft-lbs.)	③ Bushing	④ Bushing Wrench
40 Taper Shanks	KAD4	10.690.847	8	5.512	10.690.126	M12	90	10.690.654	10.690.851
	KAD5	10.690.847	8	5.512	10.690.127	M14	90	10.690.655	10.690.852
	KAD6	10.690.848	10	5.512	10.690.128	M18	120	10.690.656	10.690.853
50 Taper Shanks	KAD4	10.690.847	8	5.512	10.690.126	M12	90	10.690.654	10.690.851
	KAD5	10.690.847	8	5.512	10.690.127	M14	90	10.690.655	10.690.852
	KAD6	10.690.855	12	7.087	10.690.129	M18	150	10.690.656	10.690.853
	KAD7	10.690.850	14	5.906	10.690.130	M24	180	10.690.657	10.690.854
HSK-A63 Shanks	KAD4	10.690.847	8	5.512	10.690.126	M12	90	10.690.654	10.690.851
	KAD5	10.690.847	8	5.512	10.690.127	M14	90	10.690.655	10.690.852
	KAD6	10.690.847	8	5.512	10.690.167	M18	90	10.690.656	10.690.853
HSK-A100 Shanks	KAD5	10.690.847	8	5.512	10.690.127	M14	90	10.690.655	10.690.852
	KAD6	10.690.848	10	5.512	10.690.128	M18	120	10.690.656	10.690.853
	KAD7	10.690.848	10	5.512	10.690.168	M24	120	10.690.657	10.690.854
Extensions & Reductions	KAD4	10.690.847	8	5.512	10.690.126	M12	90	10.690.654	10.690.851
	KAD5	10.690.847	8	5.512	10.690.127	M14	90	10.690.655	10.690.852
	KAD6	10.690.849	12	5.512	10.690.129	M18	150	10.690.656	10.690.853
	KAD7	10.690.850	14	5.906	10.690.130	M24	180	10.690.657	10.690.854



BIG-PLUS® OVERVIEW



The BIG-PLUS® spindle and tooling system surpasses all other spindle concepts due to simultaneous taper and flange contact between the machine spindle and tool holder, and complete interchangeability with existing machines and tools.

Working Principle

Mounting the tool holder into the machine spindle, taper contact occurs prior to clamping. Due to the retention force, the taper of the tool holder expands the machine spindle in the elastic range. The tool is pulled further in until the tool flange touches the spindle face.

Features:

- Improved cutting performance due to higher vibration dampening and rigidity
- Better repeat accuracy for tool changes
- No change of tool length at high RPM
- Cost efficient due to further use of existing tool holders

Simultaneous Taper and Flange Fit

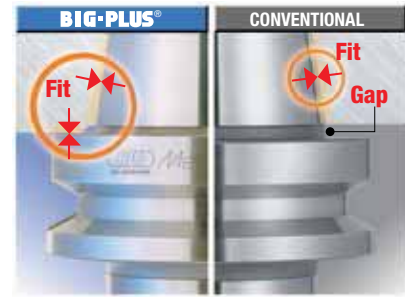

Recognized in World Markets

Comparison of Rigidity

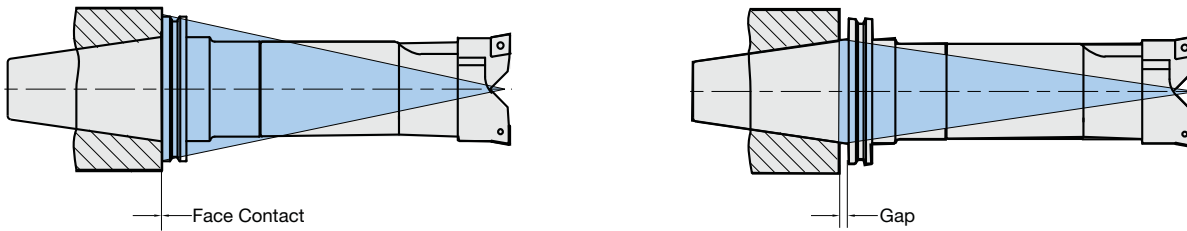

Interchangeability of Tool Shanks

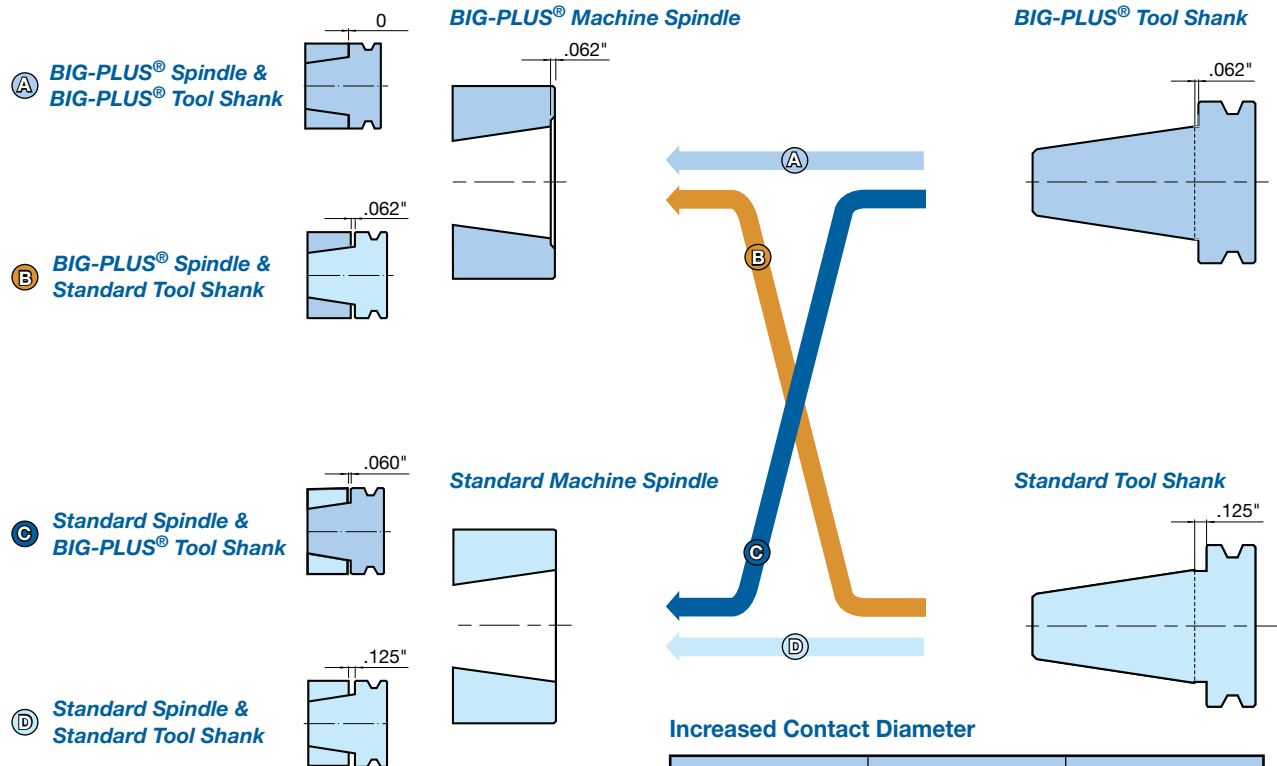

Increased Contact Diameter

Spindle Taper	Conventional	BIG-PLUS® Taper
CV50	ø2.750	ø3.875
CV40	ø1.750	ø2.500

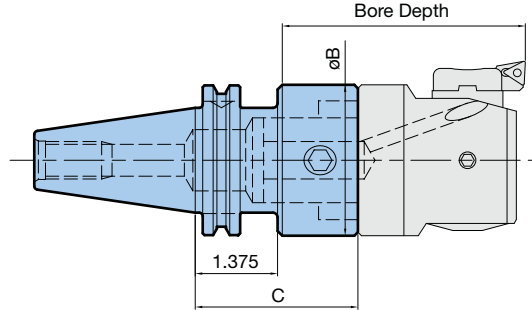

CAT40 KAB Shanks

Adapter Size	Bore Depth	Standard Taper	BIG-PLUS® Taper	øB	C
KAB1	1.570	11.326.410	—	.750	1.870
KAB1	3.150	11.326.411	—	.750	3.562
KAB2	1.970	11.326.420	—	.944	2.067
KAB2	3.150	11.326.421	—	.944	3.327
KAB2	3.937	11.326.422	—	.944	4.114
KAB3	2.165	11.326.430	—	1.220	2.126
KAB3	3.150	11.326.431	—	1.220	3.150
KAB3	5.118	11.326.433	—	1.220	5.118
KAB4	1.970	11.326.440	—	1.535	1.496
KAB4	3.150	11.326.441	11.368.441	1.535	2.874
KAB4	6.300	11.326.444	11.368.444	1.535	6.024
KAB5	3.150	11.326.451	11.368.451	1.968	2.480
KAB5	6.300	11.326.454	11.368.454	1.968	5.630
KAB6	3.937	11.326.462	11.368.462	2.491	2.716
KAB6	6.300	11.326.464	11.368.464	2.491	5.079

CAT45 KAB Shanks

Adapter Size	Bore Depth	Catalog Number	øB	C
KAB4	3.937	11.326.542	1.535	3.611
KAB5	3.937	11.326.552	1.968	3.268
KAB6	3.937	11.326.562	2.491	2.716
KAB7	6.300*	11.326.574	3.543	3.268

*For KAB7, Bore Depth applies for boring heads with length of 4.606"



CAT50 KAB SHANKS

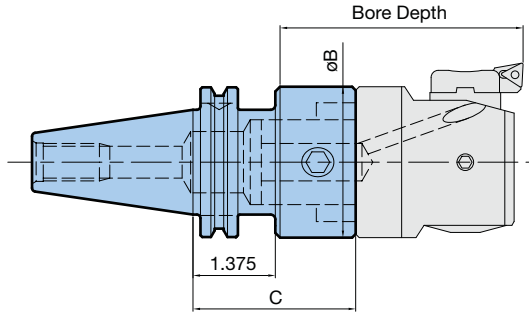

CAT50 KAB Shanks

Adapter Size	Bore Depth	Standard Taper	BIG-PLUS® Taper	øB	C
KAB1	1.570	11.326.610	—	.750	1.870
KAB1	3.150	11.326.611	—	.750	3.562
KAB2	1.970	11.326.620	—	.944	2.067
KAB2	3.937	11.326.622	—	.944	4.114
KAB2	5.118	11.326.623	—	.944	5.295
KAB3	2.165	11.326.630	—	1.220	2.126
KAB3	3.937	11.326.632	—	1.220	3.937
KAB3	5.118	11.326.633	—	1.220	5.118
KAB3	6.300	11.326.634	—	1.220	6.300
KAB4	3.937	11.326.642	11.368.642	1.535	3.611
KAB4	6.300	11.326.644	11.368.644	1.535	6.023
KAB4	7.875	11.326.645	11.368.645	1.535	7.598
KAB5	3.937	11.326.652	11.368.652	1.968	3.268
KAB5	6.300	11.326.654	11.368.654	1.968	5.630
KAB5	7.875	11.326.655	11.368.655	1.968	7.205
KAB5	10.236	11.326.656	11.368.656	1.968	9.567
KAB6	3.937	11.326.662	11.368.662	2.491	2.716
KAB6	6.300	11.326.664	11.368.664	2.491	5.079
KAB6	7.875	11.326.665	11.368.665	2.491	6.654
KAB6	10.236	11.326.666	11.368.666	2.491	9.016
KAB6	12.598	11.326.667	11.368.667	2.491	11.378
KAB7	6.300*	11.326.674	11.368.674	3.543	3.268
KAB7	8.546*	11.326.675	11.368.675	3.543	5.315
KAB7	10.236*	11.326.676	11.368.676	3.543	7.205

*For KAB7, Bore Depth applies for boring heads with length of 4.606"





DIN B Coolant Holes

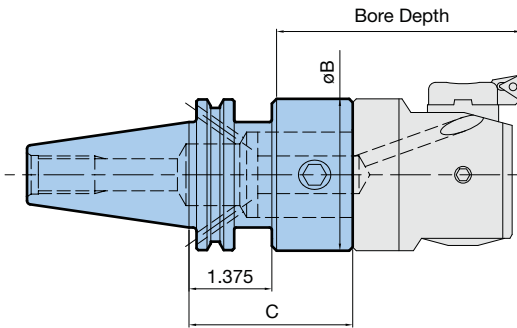

Taper	Adapter Size	Bore Depth	Catalog Number	øB	C
CAT60	KAB5	10.212	11.360.556	1.968	9.656
CAT60	KAB6	4.200	11.360.562	2.491	3.100
CAT60	KAB6	6.200	11.360.564	2.491	5.100
CAT60	KAB6	8.200	11.360.565	2.491	7.100
CAT60	KAB6	12.200	11.360.567	2.491	11.100
CAT60	KAB7	8.215*	11.360.575	3.543	5.300
CAT60	KAB7	10.215*	11.360.576	3.543	7.300
CAT60	KAB7	14.215*	11.360.578	3.543	11.300
CAT40/DIN B	KAB4	3.150	11.326.841	1.535	2.874
CAT40/DIN B	KAB5	3.150	11.326.851	1.968	2.480
CAT40/DIN B	KAB6	3.937	11.326.862	2.491	2.716
CAT50/DIN B	KAB6	3.937	11.326.962	2.491	2.716
CAT50/DIN B	KAB7	6.300*	11.326.974	3.543	3.268
CAT50/SF**	KAB7	17.320*	11.326.776	3.543	13.110

*For KAB7, Bore Depth applies for boring heads with length of 4.606"

**Simultaneous fit shanks are supplied with removable shims to be ground for flange/spindle face contact, not compatible with most ATC's, please consult BIG Kaiser's Engineering Department

CAT50 KAB Shanks, 90° Orientation

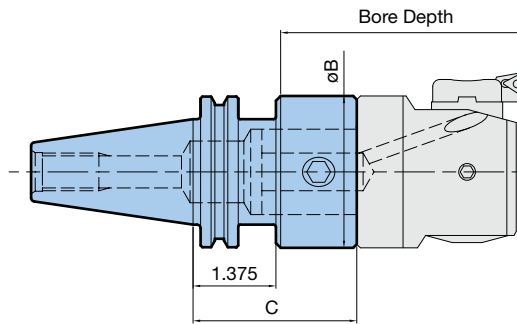

CAT50/SF KAB Shanks

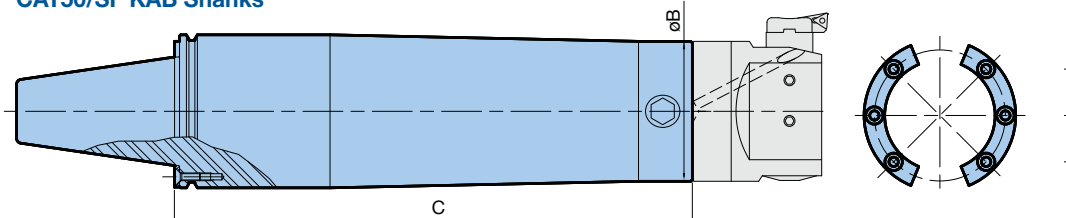

CAUTION ⚠

Shims included to be ground to match gap between spindle face and taper flange.

SPARE PARTS
PG. 4



BT30/40 KAB SHANKS

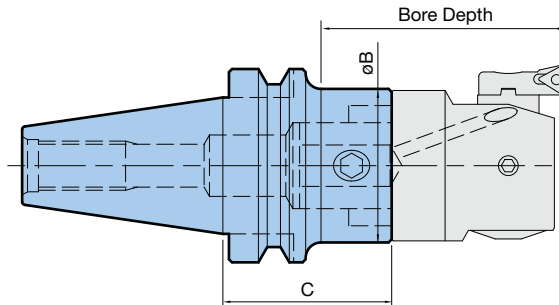

BT30 KAB Shanks

Adapter Size	Bore Depth	Standard Taper	BIG-PLUS® Taper	B	C
KAB1	2.874	BT30-CK1-105	BBT30-CK1-105	.748	2.835
KAB2	1.890	BT30-CK2-75	BBT30-CK2-75	.945	1.476
KAB2	3.661	BT30-CK2-120	BBT30-CK2-120	.945	3.248
KAB3	2.087	BT30-CK3-80	BBT30-CK3-80	1.220	1.535
KAB3	3.661	BT30-CK3-120	BBT30-CK3-120	1.220	3.110
KAB4	2.283	BT30-CK4-85	BBT30-CK4-85	1.535	1.496
KAB4	3.661	BT30-CK4-120	BBT30-CK4-120	1.535	2.874
KAB5	2.677	10.329.866	—	1.968	1.496
KAB5	3.661	BT30-CK5-120	BBT30-CK5-120	1.968	2.480
KAB6	3.661	BT30-CK6-135	BBT30-CK6-135	2.520	2.520

BT40 KAB Shanks

Adapter Size	Bore Depth	Standard Taper	BIG-PLUS® Taper	B	C
KAB1	2.874	BT40-CK1-105	BBT40-CK1-105	.748	2.835
KAB2	1.890	BT40-CK2-80	BBT40-CK2-80	.945	1.673
KAB2	3.465	BT40-CK2-120	BBT40-CK2-120	.945	3.248
KAB3	2.087	BT40-CK3-85	BBT40-CK3-85	1.220	1.732
KAB3	4.055	BT40-CK3-135	BBT40-CK3-135	1.220	3.701
KAB3	4.449	—	BBT40-CK3-165	1.220	4.882
KAB4	2.283	BT40-CK4-90	BBT40-CK4-90	1.535	1.693
KAB4	3.150	10.326.141	—	1.535	2.559
KAB4	4.055	BT40-CK4-135	BBT40-CK4-135	1.535	3.465
KAB4	5.236	—	BBT40-CK4-165	1.535	4.646
KAB4	6.417	—	BBT40-CK4-195	1.535	5.827
KAB5	3.150	10.326.151	—	1.968	2.165
KAB5	2.874	BT40-CK5-105	BBT40-CK5-105	1.968	1.890
KAB5	4.055	BT40-CK5-135	BBT40-CK5-135	1.968	3.071
KAB5	5.236	—	BBT40-CK5-165	1.968	4.252
KAB5	6.417	—	BBT40-CK5-195	1.968	5.433
KAB6	3.346	10.326.161	—	2.491	1.811
KAB6	4.055	BT40-CK6-135	BBT40-CK6-135	2.491	2.520
KAB6	5.236	—	BBT40-CK6-165	2.491	3.701
KAB6	6.417	—	BBT40-CK6-195	2.491	4.882



BT50 KAB Shanks

Adapter Size	Bore Depth	Standard Taper	BIG-PLUS® Taper	B	C
KAB1	2.874	BT50-CK1-135	BBT50-CK1-135	.748	4.016
KAB2	1.850	BT50-CK2-90	BBT50-CK2-90	.945	2.067
KAB2	4.213	BT50-CK2-150	BBT50-CK2-150	.945	4.429
KAB3	2.047	BT50-CK3-95	BBT50-CK3-95	1.220	2.126
KAB3	4.803	BT50-CK3-165	BBT50-CK3-165	1.220	4.882
KAB4	2.441	BT50-CK4-105	BBT50-CK4-105	1.535	2.283
KAB4	4.803	BT50-CK4-165	BBT50-CK4-165	1.535	4.646
KAB4	7.165	BT50-CK4-225	BBT50-CK4-225	1.535	7.008
KAB4	8.346	—	BBT50-CK4-255	1.535	8.189
KAB5	3.031	BT50-CK5-120	BBT50-CK5-120	1.968	2.480
KAB5	3.937	10.326.352	—	1.968	3.386
KAB5	4.803	BT50-CK5-165	BBT50-CK5-165	1.968	4.252
KAB5	7.756	BT50-CK5-240	BBT50-CK5-240	1.968	7.205
KAB5	9.528	BT50-CK5-285	BBT50-CK5-285	1.968	8.976
KAB5	10.906	—	BBT50-CK5-320	1.968	10.354
KAB6	3.937	10.326.362	—	2.491	2.835
KAB6	4.803	BT50-CK6-165	BBT50-CK6-165	2.491	3.701
KAB6	7.756	BT50-CK6-240	BBT50-CK6-240	2.491	6.654
KAB6	10.118	BT50-CK6-300	BBT50-CK6-300	2.491	9.016
KAB6	12.480	—	BBT50-CK6-360	2.491	11.378
KAB7	6.299	10.326.374	—	3.543	3.386
KAB7	6.772	BT50-CK7-210	BBT50-CK7-210	3.543	3.661
KAB7	10.315	BT50-CK7-300	BBT50-CK7-300	3.543	7.205
KAB7	12.677	BT50-CK7-360	BBT50-CK7-360	3.543	9.567

SPARE PARTS
PG. 4 



BIG CAPTO KAB Shanks

Taper	Adapter Size	Bore Depth	Catalog Number	øB	C
C5	KAB3	2.750	C5-CKB3-55	1.220	2.165
	KAB4	2.750	C5-CKB4-48	1.535	1.870
	KAB5	3.150	C5-CKB5-50	1.969	1.968
	KAB6	3.930	C5-CKB6-50	2.480	1.968
C6	KAB3	3.150	C6-CKB3-65	1.220	2.559
	KAB4	3.150	C6-CKB4-58	1.535	2.283
	KAB5	3.150	C6-CKB5-48	1.969	1.890
	KAB6	3.930	C6-CKB6-59	2.480	2.323
C8	KAB6	5.110	C8-CKB6-74	2.480	2.913
	KAB7	—	C8-CKB7-73	3.543	2.874
	FK135	—	10.328.086	5.315	1.811

SPARE PARTS
PG. 4 

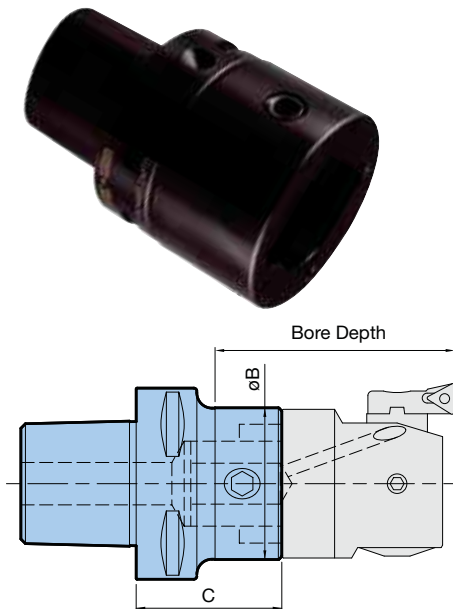

HSK-A KAB SHANKS

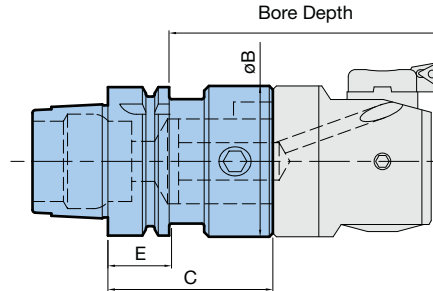

HSK-A KAB Shanks

Taper	Adapter Size	Bore Depth	Catalog Number	B	C	E
HSK-A40	KAB1	2.874	HSK-A40-CK1-73	.748	2.854	.984
HSK-A40	KAB2	1.772	HSK-A40-CK2-40	.945	1.555	.984
HSK-A40	KAB2	3.504	HSK-A40-CK2-85	.945	3.327	.984
HSK-A40	KAB3	2.028	HSK-A40-CK3-45	1.220	1.772	.984
HSK-A40	KAB3	3.346	HSK-A40-CK3-80	1.220	3.150	.984
HSK-A40	KAB4	3.740	HSK-A40-CK4-53	1.535	2.086	.984
HSK-A40	KAB5	4.528	HSK-A40-CK4-73	1.535	2.874	.984
HSK-A50	KAB1	2.598	HSK-A50-CK1-73	.748	2.854	1.220
HSK-A50	KAB2	3.189	HSK-A50-CK2-85	.945	3.327	1.220
HSK-A50	KAB3	3.268	HSK-A50-CK3-80	1.220	3.150	1.220
HSK-A50	KAB4	3.071	HSK-A50-CK4-73	1.535	2.874	1.220
HSK-A50	KAB5	5.315	HSK-A50-CK5-83	1.968	3.268	1.220
HSK-A63	KAB1	2.795	HSK-A63-CK1-78	.748	3.051	1.220
HSK-A63	KAB2	3.386	HSK-A63-CK2-90	.945	3.524	1.220
HSK-A63	KAB2	3.937	10.324.322F	.945	2.972	1.220
HSK-A63	KAB3	3.150	10.324.331	1.220	2.795	1.220
HSK-A63	KAB3	3.976	HSK-A63-CK3-100	1.220	3.937	1.220
HSK-A63	KAB3	5.118	10.324.332	1.220	4.764	1.220
HSK-A63	KAB4	4.331	10.324.341	1.535	3.701	1.220
HSK-A63	KAB4	5.118	10.324.342	1.535	4.488	1.220
HSK-A63	KAB5	3.504	10.324.352	1.968	2.323	1.220
HSK-A63	KAB5	4.685	10.324.353	1.968	3.504	1.220
HSK-A63	KAB5	6.457	10.324.354	1.968	5.276	1.220
HSK-A63	KAB6	5.512	10.324.361	2.520	2.756	1.220
HSK-A63	KAB6	6.693	10.324.362	2.520	3.937	1.220
HSK-A63	KAB6	9.055	10.324.367N	2.520	6.299	1.220
HSK-A80	KAB6	4.528	10.324.461	2.520	2.953	1.220
HSK-A100	KAB1	3.661	HSK-A100-CK1-103	.748	4.035	1.339
HSK-A100	KAB2	4.252	HSK-A100-CK2-115	.945	4.508	1.339
HSK-A100	KAB3	5.118	10.324.531	1.220	4.882	1.339
HSK-A100	KAB4	4.843	HSK-A100-CK4-118	1.535	4.646	1.339
HSK-A100	KAB4	6.299	10.324.541	1.535	5.787	1.339
HSK-A100	KAB4	7.205	HSK-A100-CK4-178	1.535	7.008	1.339
HSK-A100	KAB5	5.118	10.324.551	1.968	4.213	1.339
HSK-A100	KAB5	7.874	10.324.552	1.968	6.969	1.339
HSK-A100	KAB5	9.528	HSK-A100-CK5-228	1.968	8.976	1.339

Taper	Adapter Size	Bore Depth	Catalog Number	B	C	E
HSK-A100	KAB6	4.528	10.324.561	2.520	3.071	1.339
HSK-A100	KAB6	5.709	10.324.563	2.520	4.252	1.339
HSK-A100	KAB6	7.756	HSK-A100-CK6-169	2.520	6.654	1.339
HSK-A100	KAB6	10.236	10.324.566N	2.520	8.780	1.339
HSK-A100	KAB7	6.850	10.324.571	3.543	3.425	1.339
HSK-A100	KAB7	8.425	10.324.572	3.543	5.000	1.339
HSK-A100	KAB7	13.937	10.324.575N	3.543	10.512	1.339
HSK-A125	KAB6	5.039	HSK-A125-CK6-94	2.520	3.701	1.457
HSK-A125	KAB7	7.677	HSK-A125-CK7-123	3.543	4.843	1.772

*For KAB7, Bore Depth dimension applies for boring heads with length of 4.606"

SPARE PARTS
PG. 4 



HSK-E KAB Shanks



Taper	Adapter Size	Bore Depth	Catalog Number	B	C	E
HSK-E40	KAB3	2.165	10.324.131	1.220	1.575	.984
HSK-E40	KAB4	2.835	10.324.141	1.535	1.968	.984
HSK-E50	KAB3	2.086	10.324.231	1.220	1.732	1.220
HSK-E50	KAB4	4.331	10.324.241	1.535	3.700	1.220
HSK-E50	KAB5	4.331	10.324.251	1.968	3.306	1.220
HSK-E63	KAB6	4.331	10.324.365	2.520	2.756	1.220

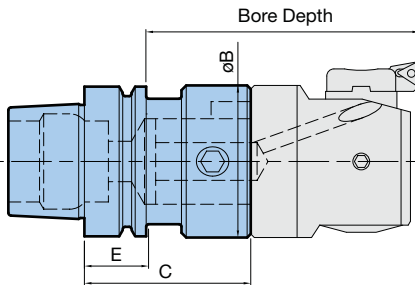

HSK-F KAB Shanks

Taper	Adapter Size	Bore Depth	Catalog Number	B	C	E
HSK-F63	KAB1	2.874	HSK-F63-CK1-78	.748	3.051	1.220
HSK-F63	KAB2	3.701	HSK-F63-CK2-90	.945	3.524	1.220
HSK-F63	KAB3	4.252	HSK-F63-CK3-100	1.220	3.937	1.220
HSK-F63	KAB4	4.252	HSK-F63-CK4-93	1.535	3.661	1.220
HSK-F63	KAB5	4.488	HSK-F63-CK5-83	1.968	3.268	1.220
HSK-F80M	KAB6	4.724	HSK-F80M-CK6-75	2.520	2.953	1.220

SPARE PARTS
PG. 4 

HSK Coolant Tubes

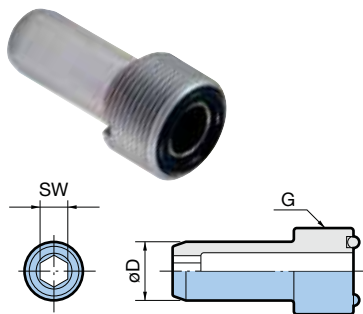

Catalog Number	ϕD	G	SW (MM)
HSK25-CP	5mm	M8 P1	2.5mm
HSK32-CP	6mm	M10 P1	3mm
HSK40-CP	8mm	M12 P1	4mm
HSK50-CP	10mm	M16 P1	5mm
HSK63-CP	12mm	M18 P1	6mm
HSK80-CP	14mm	M20 P1.5	8mm
HSK100-CP	16mm	M24 P1.5	8mm

CAUTION 

Some machine tool builders may recommend the mono block type. Contact your machine builder and verify the proper style of coolant pipe to be selected. For machines capable of supplying coolant through the spindle, the Coolant Pipe should be fitted to all HSK holders to protect against accidental selection of coolant.

MANUAL TOOL CHANGE KAB SHANKS



MT KAB Shanks

Catalog Number	L
MT3-CK1-73	47.0
-CK2-100	67.5
-CK3-100	64.0
-CK5-100	48.0
MT4-CK1-73	51.5
-CK2-100	74.0
-CK3-100	65.5
-CK4-100	59.5
-CK5-100	49.5
-CK6-100	60.5
MT5-CK1-73	78.5
-CK2-100	74.0
-CK3-125	95.5
-CK4-125	85.5
-CK5-125	74.5
-CK6-125	60.5
MT6-CK6-125	60.5

SPARE PARTS
PG. 4 

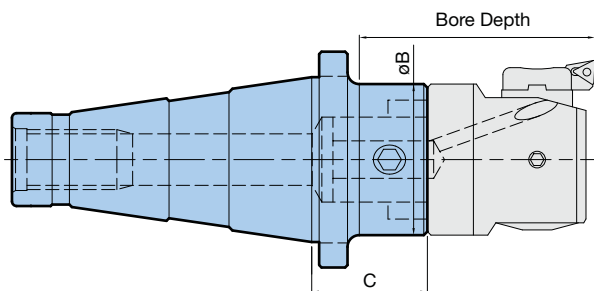

NMTB KAB Shanks

Taper	Adapter Size	Bore Depth	Catalog Number	B	C	Draw Bolt Thread
NMTB40	KAB6	4.134	11.321.562	2.491	1.772	5/8"-11
NMTB50	KAB5	3.940	11.321.952	1.968	2.480	1"-8
NMTB50	KAB6	3.940	11.321.962	2.491	1.929	
NMTB50	KAB7	5.865*	11.321.974	3.543	2.480	

*For KAB7, Bore Depth dimension applies for boring heads with length of 4.606"

SPARE PARTS
PG. 4 

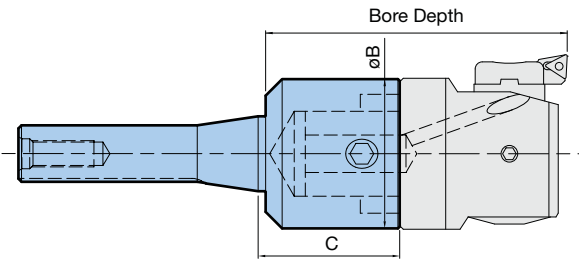

Manual Taper KAB Shanks

Taper	Adapter Size	Bore Depth	Catalog Number	B	C
R8	KAB6	5.100	11.362.261	2.490	2.362
SIP #4	KAB6	5.118	10.322.563	2.520	3.189

SPARE PARTS
PG. 4

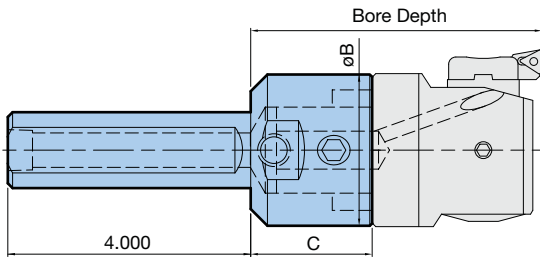

Straight Shank KAB Shanks

Shank Size	Adapter Size	Bore Depth	Catalog Number	øB	C
ø1.00 x L4.0	KAB5	4.244	11.361.052	1.968	2.000
ø1.25 x L4.0	KAB6	4.800	11.361.162	2.520	2.000
ø1.50 x L4.0	KAB6	4.800	11.361.262	2.520	2.000
ø2.00 x L4.0	KAB6	4.800	11.361.462	2.520	2.000
ø2.00 x L4.0	KAB7	7.875*	11.361.474	3.543	3.268

*For KAB7, Bore Depth dimension applies for boring heads with length of 4.606"

SPARE PARTS
PG. 4

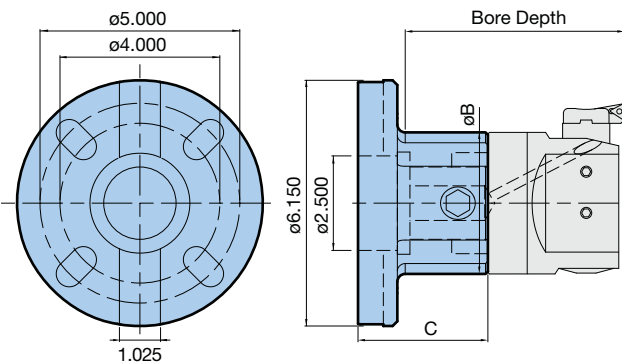

Boring Mill KAB Adapter

Type	Adapter Size	Bore Depth	Catalog Number	øB	C
6" Flange	KAB7	6.560*	11.366.774	3.543	3.250

*For KAB7, Bore Depth dimension applies for boring heads with length of 4.606"

SPARE PARTS
PG. 4

KAB REDUCTION ADAPTERS

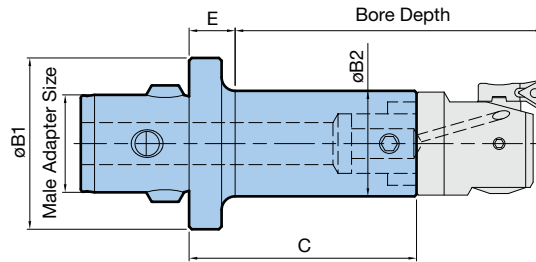

KAB Reductions

Male Adapter	Female Adapter	Bore Depth	Catalog Number	$\phi B1$	$\phi B2$	C	E
KAB2	KAB1	2.165	10.332.210	.945	.748	1.417	.413
KAB3	KAB1	2.362	10.332.310	1.220	.748	1.594	.394
KAB3	KAB2	2.362	10.332.320	1.220	.945	1.358	.394
KAB4	KAB1	2.953	10.332.410	1.535	.748	2.264	.472
KAB4	KAB2	2.953	10.332.420	1.535	.945	2.028	.472
KAB4	KAB3	2.953	10.332.430	1.535	1.220	1.850	.472
KAB5	KAB1	2.756	10.332.511	1.968	.748	2.264	.669
KAB5	KAB1	3.937	10.332.510	1.968	.748	3.445	.669
KAB5	KAB2	2.756	11.332.521	1.968	.945	2.028	.669
KAB5	KAB2	3.937	11.332.520	1.968	.945	3.209	.669
KAB5	KAB3	2.756	10.332.531	1.968	1.220	1.850	.669
KAB5	KAB3	3.937	10.332.530	1.968	1.220	3.031	.669
KAB5	KAB4	2.756	11.332.541	1.968	1.535	1.575	.669
KAB5	KAB4*	3.937	11.332.540	1.968	1.535	2.756	.669
KAB6	KAB1	2.559	10.332.611	2.500	.748	2.618	1.220
KAB6	KAB1	3.937	11.332.610	2.500	.748	3.996	1.220
KAB6	KAB2	3.150	11.332.621	2.500	.945	2.382	.630
KAB6	KAB2	4.528	11.332.620	2.500	.945	3.760	.630
KAB6	KAB3	3.150	11.332.631	2.500	1.220	2.205	.630
KAB6	KAB3	4.528	11.332.630	2.500	1.220	3.583	.630
KAB6	KAB3	6.300	11.332.632	2.500	1.220	5.354	.630
KAB6	KAB4	3.150	11.332.641	2.500	1.535	1.929	.630
KAB6	KAB4*	4.528	11.332.640	2.500	1.535	3.307	.630
KAB6	KAB4*	6.300	11.332.642	2.500	1.535	5.079	.630
KAB6	KAB5	3.150	11.332.651	2.500	1.968	1.535	.630
KAB6	KAB5*	4.528	11.332.650	2.500	1.968	2.913	.630
KAB6	KAB5*	6.300	11.332.652	2.500	1.968	4.685	.630
KAB7	KAB4	3.937	10.332.741	3.543	1.535	2.756	.669
KAB7	KAB5*	3.937	10.332.751	3.543	1.969	2.362	.669
KAB7	KAB5*	6.300	10.332.750	3.543	1.969	4.724	.669
KAB7	KAB6	5.118	11.332.761	3.543	2.520	2.992	.669
KAB7	KAB6*	6.300	11.332.760	3.543	2.520	4.173	.669

*KAD compatible



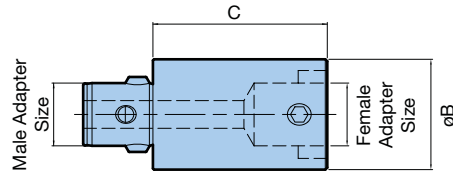

KAB Extensions

Male Adapter	Female Adapter	Catalog Number	øB	C
KAB1	KAB1	10.331.110	.748	.787
KAB1	KAB1	10.331.111	.748	1.181
KAB2	KAB2	11.331.220	.945	1.181
KAB2	KAB2	11.331.221	.945	1.772
KAB3	KAB3	11.331.330	1.220	1.181
KAB3	KAB3	11.331.331	1.220	1.772
KAB4	KAB4	11.331.440	1.535	1.575
KAB4	KAB4*	11.331.441	1.535	2.362
KAB5	KAB5	11.331.550	1.968	2.362
KAB5	KAB5*	11.331.551	1.968	3.543
KAB6	KAB6	11.331.660	2.491	2.362
KAB6	KAB6*	11.331.661	2.491	3.937
KAB7	KAB7	11.331.770	3.543	3.937
KAB7	KAB7*	11.331.771	3.543	6.299

*KAD compatible

SPARE PARTS
PG. 4 



HYDRAULIC CHUCKS CLAMPING SYSTEM FOR KAB CARBIDE & HEAVY METAL BARS

NEW!

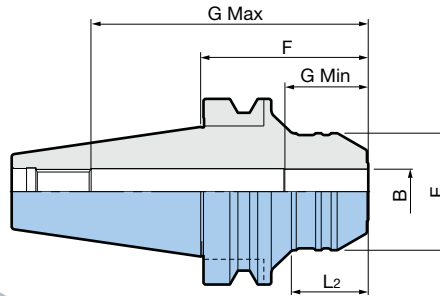

Taper	øB	Catalog Number	øE	F	G Min	G Max
CAT40	19mm	BCV40-HDC19-75	2.087	2.950	1.693	4.370
	.750	BCV40-HDC.750-3	1.654	3.000	1.693	2.756
	24mm	BCV40-HDC24-75	2.480	2.950	1.772	4.094
	31mm	BCV40H-HDC31-80	2.913	3.150	2.205	2.992
	1.250	BCV40-HDC1.250-4	2.953	4.000	2.205	3.150
CAT50	19mm	BCV50-HDC19L-90	1.937	3.543	1.693	5.866
	.750	BCV50-HDC.750-3.5	1.654	3.500	1.693	2.756
	24mm	BCV50-HDC24L-90	2.480	3.543	1.772	5.866
	31mm	BCV50-HDC31L-90	2.913	3.543	2.205	5.787
	1.250	BCV50-HDC1.250-3.5	2.750	3.500	2.205	3.150
BT40	19mm	BBT40-HDC19-75	1.937	2.950	1.693	4.370
	.750	BBT40-HDC.750-3	1.654	3.000	1.693	2.756
	24mm	BBT40-HDC24-75	2.480	2.950	1.772	4.094
	31mm	BBT40-HDC31-75	2.913	2.950	2.205	2.992
	1.250	BBT40-HDC1.250-3.5	2.953	3.500	2.205	3.150
BT50	19mm	BBT50-HDC19L-90	1.937	3.543	1.693	5.866
	24mm	BBT50-HDC24L-90	2.480	3.543	1.772	5.866
	31mm	BBT50-HDC31L-90	2.835	3.543	2.205	5.787

Straight Collet

Reduction sleeve for smaller diameter cutters.

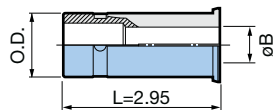

O.D.	øB	Catalog Number
31mm	21mm	OCA31-21
	23mm	OCA31-23
	27mm	OCA31-27

- Min. order quantity 25 pcs.
- OCA31-29 is not possible

Tool combinations with carbide boring bars provide optimum rigidity when machining extremely long bores.

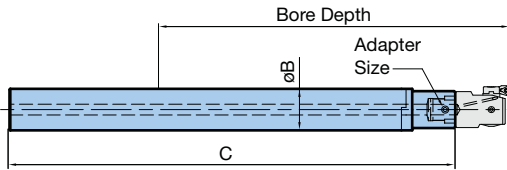

KAB Carbide Bars for Finishing

Adapter Size	øB	Bore Depth	Catalog Number	C	Bore Diameter	
					Min	Max
KAB1	19mm	5.000	10.335.320	5.511	.787	1.417
KAB1	19mm	6.969	10.335.321	7.480	.787	1.417
KAB1	19mm	8.938	10.335.322	9.449	.787	1.417
KAB1	21mm	4.488	10.335.380	5.511	.866	1.417
KAB1	21mm	6.457	10.335.381	7.480	.866	1.417
KAB1	21mm	8.426	10.335.382	9.449	.866	1.417
KAB1	23mm	4.488	10.335.383	5.511	.945	1.417
KAB1	23mm	6.457	10.335.384	7.480	.945	1.417
KAB1	23mm	8.426	10.335.385	9.449	.945	1.417
KAB2	24mm	5.827	10.335.323	6.299	.984	1.850
KAB2	24mm	8.189	10.335.324	8.661	.984	1.850
KAB2	24mm	10.945	10.335.325	11.417	.984	1.850
KAB2	27mm	5.394	10.335.386	6.299	1.102	1.850
KAB2	27mm	7.756	10.335.387	8.661	1.102	1.850
KAB2	27mm	10.512	10.335.388	11.417	1.102	1.850
KAB3	31mm	7.146	10.335.326	7.874	1.260	2.362
KAB3	31mm	9.508	10.335.331	10.236	1.260	2.362
KAB3	31mm	13.052	10.335.327	13.780	1.260	2.362

CAUTION

These bars should not be used for heavy roughing.



Tool combinations with heavy metal boring bars give higher rigidity and damping of vibration over conventional steel shank tools when roughing long bores over 5:1. Their dense structure and machinability gives higher toughness over carbide.

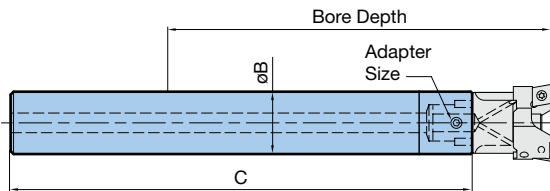

KAB Heavy Metal Bars for Roughing

Adapter Size	øB	Bore Depth	Catalog Number	C	Bore Diameter	
					Min	Max
KAB1	.750	6.410	11.370.321	7.480	.787	1.220
KAB1	.750	8.380	11.370.322	9.450	.787	1.220
KAB2	24mm	7.128	11.370.324	8.580	.984	1.575
KAB2	24mm	9.968	11.370.325	11.420	.984	1.575
KAB3	1.250	7.975	11.370.328	9.250	1.260	2.008
KAB3	1.250	12.505	11.370.327	13.780	1.260	2.008
KAB4	1.500	9.000	11.370.330	10.000	1.614	2.598
KAB4	1.500	13.750	11.370.101	14.750	1.614	2.598



SMART DAMPER KAB MODULAR TOOL DAMPING SYSTEM



NEW!

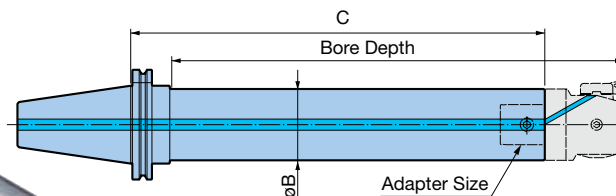

SPARE PARTS
PG. 4

Taper	Adapter Size	Bore Depth	Catalog Number	øB	C
BCV50	KAB4	10.000	11.368.646	1.535	9.726
	KAB5	12.800	11.368.657	1.968	12.133
	KAB6	16.000	11.368.668	2.520	14.624
BBT50	KAB4	9.685	BBT50-CK4DP-299	1.535	9.921
	KAB5	12.520	BBT50-CK5DP-371	1.968	12.362
	KAB6	16.063	BBT50-CK6DP-451	2.520	14.961

- Insert is aligned with drive keys for tool orientation
- Boring head, inserts, etc. are sold separately

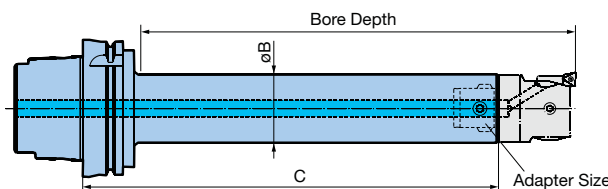

Taper	Adapter Size	Bore Depth	Catalog Number	øB	C
HSK-A100	KAB4	9.685	HSK-A100-CK4DP-241	1.535	9.488
	KAB5	12.520	HSK-A100-CK5DP-303	1.968	11.929
	KAB6	16.063	HSK-A100-CK6DP-379	2.520	14.921

- Insert is aligned with drive keys for tool orientation
- Boring head, inserts, etc. are sold separately

SPARE PARTS
PG. 4

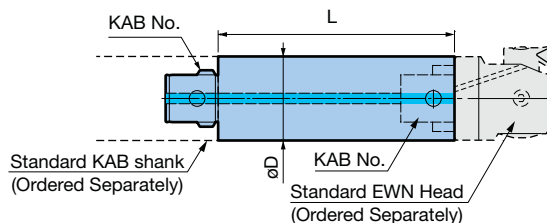

Extension

Catalog Number	Adapter Size	øD	L	Weight (lbs.)
CK44DP-120	KAB4	1.535	4.724	2.9
CK55DP-150	KAB5	1.968	5.906	5.7
CK66DP-180	KAB6	2.520	7.087	12.3

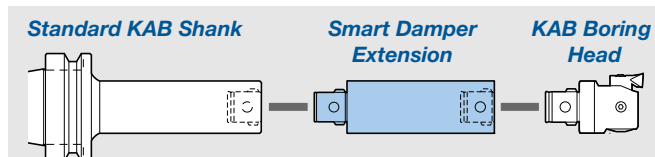

- Additional reductions cannot be used together with the Smart Damper Extensions

SPARE PARTS
PG. 4

U.S. PATENT
7,585,139

Maximum Torque Transmission with Aluminum Tool Components

The CKN connection is almost 100% compatible with KAB and is based on a 3 screw connection with double connector steel couplings and aluminum tubes as extensions, allowing the highest torque transmission. By tightening the 3 screws, the slotted male connection expands and gives additional rigidity to the tool connection.

Features:

- Double connector couplings and aluminum extensions for the transmission of high torque
- Weight reductions up to 50% with equal cutting performance compared to tool combinations made of steel
- Reduced weight allows easier handling and eliminates manual tool change in many cases
- Maximum rigidity of the tool connection due to high clamping force and expansion of the slotted tool connector
- Vibration damping due to the use of different materials
- Various lengths of steel couplings & aluminum extensions allow optimized tool length

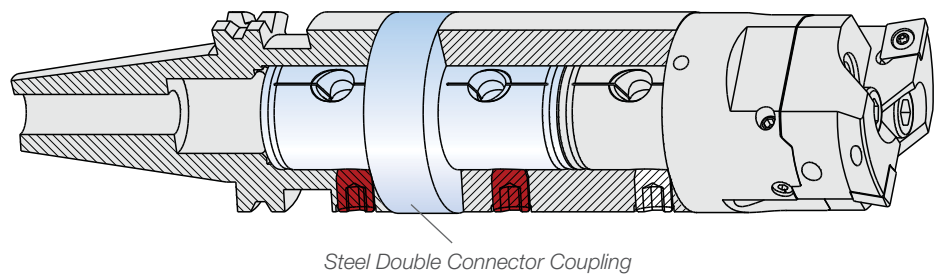
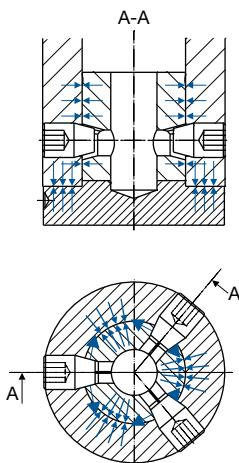
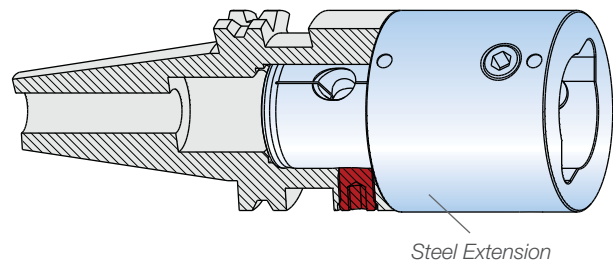
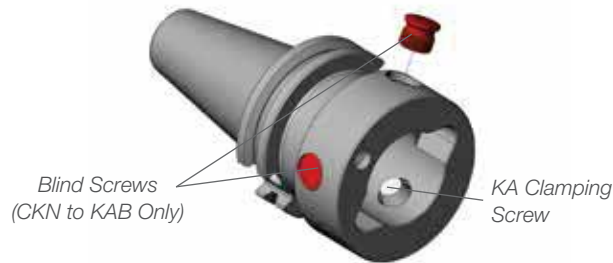

CKN SHANKS

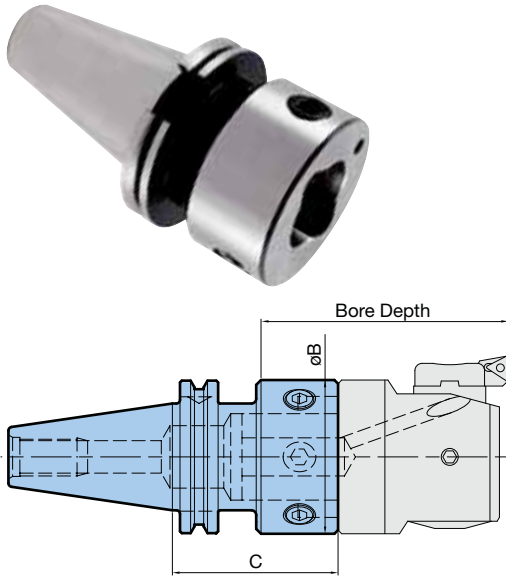

CAT CKN Shanks (ASME B5.50)

Taper Size	Adapter Size	Bore Depth	Standard Taper	BIG-PLUS® Taper	øB	C
CAT40	CKN6	3.937	11.326.462N	11.368.462N	2.500	2.716
CAT40	CKN6	6.300	11.326.464N	—	2.500	5.079
CAT50	CKN6	3.937	11.326.662N	11.368.662N	2.500	2.716
CAT50	CKN6	6.300	11.326.664N	11.368.664N	2.500	5.079
CAT50	CKN6	7.875	11.326.665N	—	2.500	6.654
CAT50	CKN6	10.236	11.326.666N	11.368.666N	2.500	9.016
CAT50	CKN6	12.598	11.326.667N	11.368.667N	2.500	11.378
CAT50	CKN7	6.300*	11.326.674N	11.368.674N	3.543	3.268
CAT50	CKN7	8.546*	11.326.675N	11.368.675N	3.543	5.315
CAT50	CKN7	10.236*	11.326.676N	—	3.543	7.205

*For CKN7, Bore Depth applies for boring heads with length of 4.606"

SPARE PARTS
PG. 4 & 22

BT CKN Shanks (MAS 403)

Taper	Adapter Size	Bore Depth	Standard Taper	BIG-PLUS® Taper	øB	C
BT40	CKN6	3.346	10.323.735N	10.323.832N	2.500	1.811
BT40	CKN6	3.937	10.323.736N	10.323.831N	2.500	2.402
BT50	CKN6	3.937	10.323.775N	10.323.874N	2.500	2.835
BT50	CKN7	6.300*	10.323.776N	10.323.871N	3.543	3.386

*For CKN7, Bore Depth applies for boring heads with length of 4.606"

SPARE PARTS
PG. 4 & 22

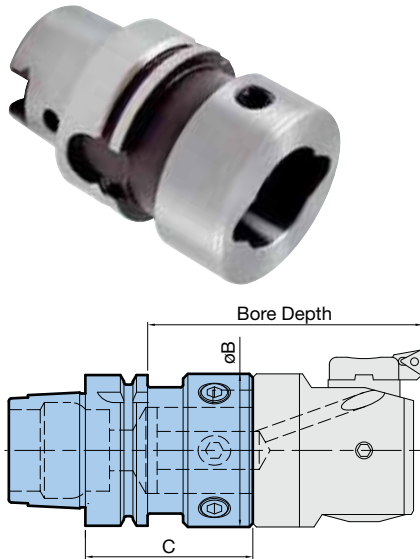

HSK-A CKN Shanks (DIN 69893)

Taper Size	Adapter Size	Bore Depth	Catalog Number	øB	C
HSK-A63	CKN6	4.331	10.324.361N	2.500	2.756
HSK-A63	CKN6	7.874	10.324.367N	2.500	6.300
HSK-A100	CKN6	4.528	10.324.561N	2.500	3.071
HSK-A100	CKN6	5.709	10.324.563N	2.500	4.252
HSK-A100	CKN6	10.236	10.324.566N	2.500	8.780
HSK-A100	CKN7	6.693*	10.324.571N	3.543	3.425
HSK-A100	CKN7	8.268*	10.324.572N	3.543	5.000
HSK-A100	CKN7	12.598*	10.324.575N	3.543	10.512

*For CKN7, Bore Depth applies for boring heads with length of 4.606"

SPARE PARTS
PG. 4 & 22

Blind Screws



Catalog Number	Designation
10.690.666	CKN6xB5M12x1.0
10.690.667	CKN7xB5M20x1.5

CKN Shanks are supplied with only one KA screw, and the remaining two screws are supplied with all mating CKN components. For CKN to KAB assemblies, two blind screws are required.

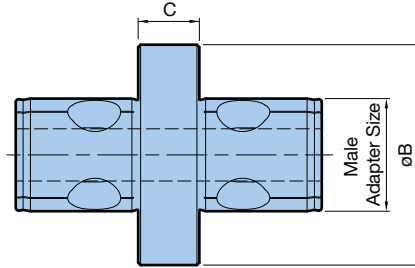

Steel CKN Double Connector Couplings

Male Adapter	Catalog Number	øB	C
CKN6	10.331.864N	2.500	0
CKN6	10.331.865N	2.500	.787
CKN7	10.331.874N	3.543	0
CKN7	10.331.875N	3.543	.984
CKN7	10.331.876N	3.543	1.968

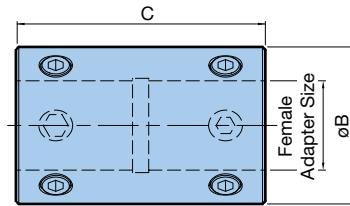

Aluminum CKN Extension Tubes

Female Adapter	Catalog Number	øB	C
CKN6	10.331.867N	2.500	3.150
CKN6	10.331.868N	2.500	4.724
CKN7	10.331.877N	3.543	3.937
CKN7	10.331.879N	3.543	5.905
CKN7	10.331.878N	3.543	7.874

SPARE PARTS
PG. 4 & 22

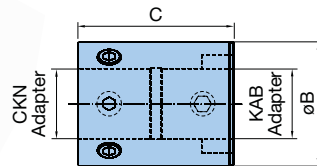

Aluminum CKN-KAB Extensions & Reductions

CKN Adapter	KAB Adapter	Catalog Number	øB	C
CKN6	KAB6	10.331.860N	2.500	3.150
CKN6	KAB6	10.331.861N	2.500	4.724
CKN7	KAB7	10.331.870N	3.543	3.937
CKN7	KAB7	10.331.871N	3.543	5.905
CKN7	KAB6	10.332.870N	3.543/2.500	3.937

SPARE PARTS
PG. 4 & 22



KAB COOLANT INDUCER

Hi-Jet Holder

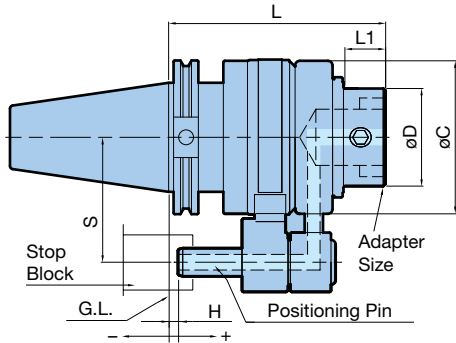

Hi-Jet Holder coolant inducers are for machines without coolant through the spindle. Suitable for automatic tool changer.

Features:

- Sturdy one-piece design of shank and tool holder
- KA6 or KA7 connection for universal use with boring, milling, internal turning and thread-cutting tools
- Various design features and special coated seal rings enable the coolant inducer to be used with a maximum coolant pressure of 284 PSI and speeds up to 6,000 RPM
- Positioning ring is adjustable from 0° to 360°; therefore the coolant connection can be located in any position
- Three different positioning pins with various setting dimensions allow simple installation of the stop block on the machine tool
- The check valve built into the positioning pin prevents coolant leakage during tool change
- Positive groove location guarantees against leakage between the stop block and the positioning pin

Catalog Number	Adapter Size	øD	L	L1	C	S	Max RPM	Merit Set
CV40-OCK6N-144	KAB6	2.520	5.669	1.102	3.921	2.559	5,000	MES-65
CV50-OCK6N-142	KAB6	2.520	5.591	1.063	3.921	3.150	5,000	MES-65
CV50-OCK7N-165	KAB7	3.543	6.496	1.358	5.102	3.150	4,000	MES-90

Catalog Number	Adapter Size	øD	L	L1	C	S	Max RPM	Merit Set
BBT40-OCK6N-149	KAB6	2.520	5.866	1.102	3.921	2.559	6,000	MES-65
BBT50-OCK6N-139	KAB6	2.520	5.472	1.063	3.921	3.150	6,000	MES-65
BBT50-OCK7N-165	KAB7	3.543	6.496	1.358	5.102	3.150	4,000	MES-90

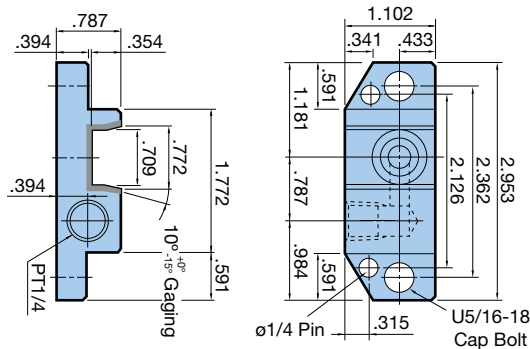

Stop Block

A semi-finished stop block has the proper groove form for use with the Hi-Jet Holder coolant inducer, as well as additional material to allow the customer to machine the block to the correct height.

If a pre-made stop block is unobtainable from the machine tool builder, a semi-finished stop block can be used.

Please consult with the machine tool builder for selection, machining, and mounting of the semi-finished stop block.

Positioning Pins

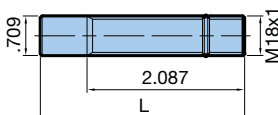

Catalog Number	CV/BT40 H (-/+)	CV/BT50 H (-/+)	L
LP-A	-.236/+.354	-.354/+.236	3.661
LP-B	+.354/+.945	+.236/+.827	3.071
LP-C	+.945/+1.535	+.827/+1.417	2.480

CAUTION

Setting dimension H depends on the length of the positioning pin (see above) and is measured from the gage line of the taper.



Series 336 Insert Drill

Features:

- Large, helical flutes reinforced at the edges provide highest strength and chip space
- Through the tool coolant, directed on both sides at the cutting edges to guarantee optimum cooling and chip evacuation
- Case hardened steel construction for maximum rigidity and toughness

KAB6 and KAB7 Connection Provides:

- Highest stability by clamping the drill to the shank both axially and radially at the largest seating diameter
- Lowest amount of drill runout
- Minimum gauge lengths
- Versatile KAB6 connection for all diameters 3/4" to 2-1/2" allows more flexibility on smaller machines
- Widest range of shanks and coolant inducers

Carbide Inserts:

- ISO standard WCMX inserts for both inside and outside cutting edges provide 3 indexes
- Positive cutting geometry for reduced cutting forces
- Different grades optimize cutting conditions

Insert Drill Sizes:

- KAB6 connection, $\phi 3/4"$ to $\phi 2-1/2"$ and $\phi 31\text{mm}$ to $\phi 61\text{mm}$
- KAB7 connection, $\phi 2-5/8"$ to $\phi 2-7/8"$

Insert Drill Lengths:

- 2xD and 3xD for all sizes

APPLICATION GUIDELINES
PG. 33



Series 337 Insert Drill

Features:

- Straight flute design guarantees a short distance for chip evacuation, high radial and torsional rigidity, and very high cutting performance
- Clockwise cutting, with 4-edge inserts, also suitable to enlarge pre-drilled holes
- Through tool coolant supply to the cutting edge
- Suitable for use as rotating or stationary
- With adjustable drill holder for hole diameters with fractional sizes such as core bores or rough bores before finishing (adjustment range according to table)

KAB6 Connection Provides:

- Very high clamping force, a short gauge length and a large seating diameter
- Suitable for drilling under extreme conditions such as inclined surfaces, semi-circle bores and transverse bores

Carbide Inserts:

- Same insert type for inner and outer insert
- Indexable inserts for all kinds of workpiece materials, with 4 true cutting edges

Insert Drill Sizes:

- KAB6 connection, $\phi 16\text{mm}$ to $\phi 30\text{mm}$

Insert Drill Lengths:

- 3xD and 4xD for all sizes



INDEXABLE INSERT DRILLS ϕ .750"-2.875"

Series 336

INCH

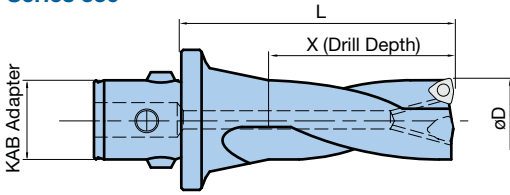

Drill øD	KAB Adapter	Indexable Drills 2x Dia.			Indexable Drills 3x Dia.			Inside Insert	Outside Insert
		Catalog Number	X	L	Catalog Number	X	L		
.750	KAB6	10.336.001	1.500	2.952	10.336.050	2.250	3.543	WC..04	WC..03
.781		10.336.002	1.562		10.336.051	2.343			
.812		10.336.003	1.625		10.336.052	2.436			
.845		10.336.004	1.690	3.150	10.336.053	2.535	3.937	WC..05	WC..04
.875		10.336.005	1.750		10.336.054	2.625			
.906		10.336.006	1.812		10.336.055	2.718			
.938		10.336.007	1.875	3.543	10.336.056	2.815	4.331		
.968		10.336.008	1.938		10.336.057	2.907			
1.000		10.336.009	2.000		10.336.058	3.000			
1.031		10.336.010	2.062	3.937	10.336.059	3.093	4.528	WC..05	
1.063		10.336.011	2.125		10.336.060	3.189			
1.094		10.336.012	2.188		10.336.061	3.282			
1.125		10.336.013	2.250	4.331	10.336.062	3.375	4.921		
1.156		10.336.014	2.312		10.336.063	3.468			
1.188		10.336.015	2.375		10.336.064	3.564			
1.219		10.336.016	2.438	5.118	10.336.065	3.657	5.118	WC..06	
1.250		10.336.017	2.500		10.336.066	3.750			
1.312		10.336.018	2.625		10.336.067	3.938			
1.375		10.336.019	2.750	4.921	10.336.068	4.125	5.512		
1.438		10.336.020	2.875		10.336.069	4.314			
1.500		10.336.021	3.000		10.336.070	4.500			
1.563		10.336.022	3.125	5.906	10.336.071	4.688	6.299	WC..08	
1.625		10.336.023	3.250		10.336.072	4.875			
1.688		10.336.024	3.375		10.336.073	5.064			
1.750		10.336.025	3.500	5.512	10.336.074	5.250	7.087		
1.812		10.336.026	3.625		10.336.075	5.436			
1.875		10.336.027	3.750		10.336.076	5.625			
1.938		10.336.028	3.875	6.496	10.336.077	5.814	7.480		
2.000		10.336.029	4.000		10.336.078	6.000			
2.063		10.336.030	4.125		10.336.079	6.188			
2.125	10.336.031	4.250	5.906	10.336.080	6.375	7.874	WC..08		
2.188	10.336.032	4.375		10.336.081	6.564				
2.250	10.336.033	4.500		10.336.082	6.750				
2.312	10.336.034	4.625	6.299	10.336.083	6.936	8.465			
2.375	10.336.035	4.750		10.336.084	7.125				
2.438	10.336.036	4.875		10.336.085	7.314				
2.500	10.336.037	5.000	6.496	10.336.086	7.500	9.252			
2.625	10.336.038*	5.250		10.336.087*	7.875				
2.750	—	—		10.336.088	8.250				
2.875	10.336.040*	5.750	8.268	10.336.089*	8.625	11.024	WC..10		

*Available as long as stock lasts

Series 337

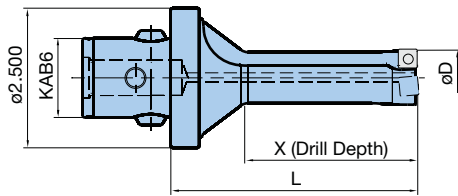

Series 336

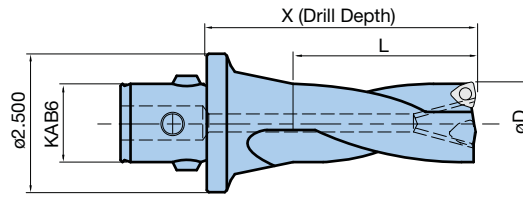

METRIC

Drill øD	Series	Indexable Drills 3xD			Indexable Drills 4xD			Inserts
		Catalog Number	X	L	Catalog Number	X	L	
16	337	10.337.316	48	85	10.337.416	64	101	WP 337-1
17		10.337.317	51	88	10.337.417	68	105	
18		10.337.318	54	91	10.337.418	72	109	
19		10.337.319	57	94	10.337.419	76	113	
20		10.337.320	60	97	10.337.420	80	117	
21		10.337.321	63	100	10.337.421	84	121	WP 337-2
22		10.337.322	66	103	10.337.422	88	125	
23		10.337.323	69	106	10.337.423	92	129	
24		10.337.324	72	109	10.337.424	96	133	
25		10.337.325	75	112	10.337.425	100	137	
26		10.337.326	78	118	10.337.426	104	146	WP 337-3
27		10.337.327	81	121	10.337.427	108	150	
28		10.337.328	84	124	10.337.428	112	154	
29		10.337.329	87	127	10.337.429	116	158	
30	10.337.330	90	130	10.337.430	120	162		
Indexable Drills 2xD				Indexable Drills 3xD				
31	336	10.336.631	62	100	10.336.731	93	130	WC..06
32		10.336.632	64		10.336.732	96		
33		10.336.633	66		10.336.733	99	140	
34		10.336.634	68	10.336.734	102			
35		10.336.635	70	110	10.336.735	105	150	
36		10.336.636	72		10.336.736	108		
37		10.336.637	74		10.336.737	111		
38		10.336.638	76	125	10.336.738	114	160	
39		10.336.639	78		10.336.739	117		
40		10.336.640	80		10.336.740	120	165	
41		10.336.641	82	10.336.741	123			
42		10.336.642	84	10.336.742	126			
43		10.336.643	86	140	10.336.743	129	180	
44		10.336.644	88		10.336.744	132		
45		10.336.645	90		10.336.745	135		
47		10.336.647	94	150	10.336.747	141	190	
49		10.336.649	98		10.336.749	147		
51		10.336.651	102		10.336.751	153		200
53		10.336.653	106	160	10.336.753	159		
55		10.336.655	110		10.336.755	165	215	
57		10.336.657	114	165	10.336.757	171		
59	10.336.659	118	10.336.759		177	220		
61	10.336.661	122	10.336.761		183		WC..10	



ADJUSTABLE DRILL HOLDERS

KAB6 Integral Shank Drill Holders for Diameter Adjustment of Indexable Insert Drills

- Accurate, easy-to-read adjusting collar gives ± 0.004 "/div. adjusting precision which can be split for ± 0.002 "/div. or better
- Extremely compact and rigid design for drilling under all conditions
- One holder suitable for ± 0.748 "-2.500"
- Wide adjustment range: Nominal drill ± 0.040 ", -0.008 "

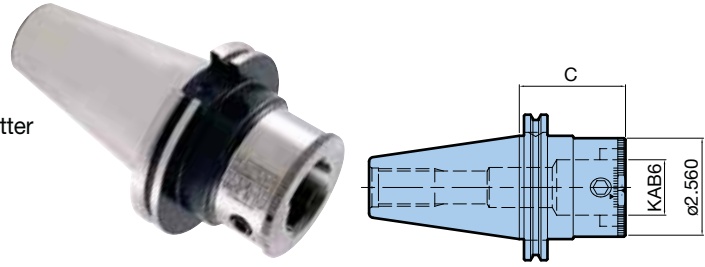

CAT40/50 KAB Holder (ASME B5.50)

Taper	Adapter Size	Catalog Number	C
CV40	KAB6	11.336.311	3.189
CV50	KAB6	11.336.313	2.716
CV50/DIN B	KAB6	11.336.315	2.716

Off-Axis Use of Indexable Insert Drills Series 337

Insert Size	Drill ϕD	Adjustable Range		Bore Diameter	
		-Z	+Z	Min	Max
WP 337-1	16mm	N/A	1.7mm	16mm	19.4mm
	17mm		1.5mm	17mm	20mm
	18mm		1.3mm	18mm	20.6mm
	19mm		1mm	19mm	21mm
	20mm		.8mm	20mm	21.6mm
WP 337-2	21mm	N/A	2mm	21mm	25mm
	22mm		1.7mm	22mm	25.4mm
	23mm		1.5mm	23mm	26mm
	24mm		1.2mm	24mm	26.4mm
	25mm		1mm	25mm	27mm
WP 337-3	26mm	N/A	1.7mm	26mm	29.4mm
	27mm		1.4mm	27mm	29.8mm
	28mm		1.2mm	28mm	30.4mm
	29mm		.9mm	29mm	30.8mm
	30mm		.7mm	30mm	31.4mm

Stationary Drilling

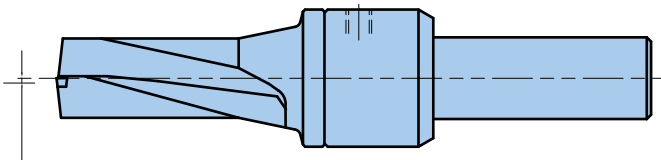

Max .0015" to the middle axis of the spindle

KAISER Indexable Insert Drills rotate clockwise. Check direction of rotation.

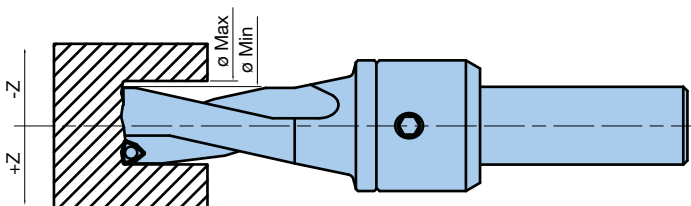

Off-Axis Use of Indexable Insert Drills Series 336

Insert Size	Drill ϕD	Adjustable Range		Bore Diameter	
		-Z	+Z	Min	Max
WC..03	.750	.010	.060	.730	.870
	.781	.010	.050	.761	.881
	.812	.010	.040	.792	.892
WC..04	.845	.010	.080	.825	1.005
	.875	.010	.070	.855	1.015
	.906	.010	.060	.886	1.026
	.938	.010	.050	.918	1.038
	.968	.010	.040	.948	1.048
	1.000	.010	.030	.980	1.060
WC..05	1.031	.010	.100	1.011	1.231
	1.063	.010	.090	1.043	1.243
	1.094	.010	.080	1.074	1.254
	1.125	.010	.070	1.105	1.265
	1.156	.010	.060	1.136	1.276
	1.188	.010	.050	1.168	1.288
WC..06	1.219	.010	.140	1.199	1.499
	1.250	.010	.130	1.230	1.510
	1.312	.010	.120	1.292	1.552
	1.375	.010	.100	1.355	1.575
	1.438	.010	.080	1.418	1.598
	1.500	.010	.070	1.480	1.640
	1.563	.010	.050	1.543	1.663
	1.625	.010	.040	1.605	1.705
	1.688	.010	.020	1.668	1.728
	1.750	.020	.150	1.710	2.050
WC..08	1.812	.020	.140	1.772	2.092
	1.875	.020	.130	1.835	2.135
	1.938	.020	.120	1.898	2.178
	2.000	.020	.100	1.960	2.200
	2.063	.020	.080	2.023	2.223
	2.125	.020	.070	2.085	2.265
	2.188	.020	.050	2.148	2.288
	2.250	.020	.040	2.210	2.330
	2.312	.020	.020	2.272	2.352
	2.375	.020	.010	2.335	2.395
WC..10	2.438	.020	.160	2.398	2.758
	2.500	.020	.150	2.460	2.800
	2.625	.020	.120	2.585	2.865
	2.750	.020	.090	2.710	2.930
	2.875	.020	.060	2.835	2.995
	3.000	.020	.030	2.960	3.060

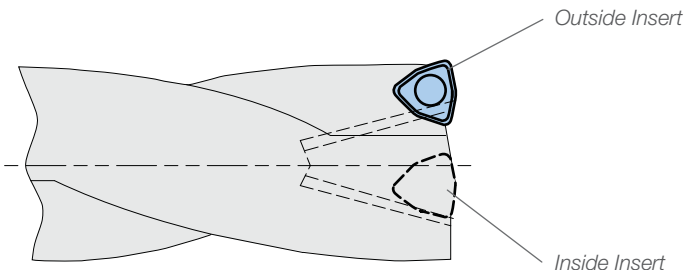

Insert Selection

Material	Inside/Outside Insert - Series 336						Inside/Outside Insert - Series 337		
	WC..03	WC..04	WC..05	WC..06	WC..08	WC..10	337-1	337-2	337-3
Carbon Steels 10XX-15XX 1018, 1212, 1551	11.658.620	11.658.630	11.658.640	11.658.650	11.658.660	10.655.670	10.655.910	10.655.920	10.655.930
Alloy Steels 21XX-92XX 4130, 4340, 8620	11.658.620	11.658.630	11.658.640	11.658.650	11.658.660	10.655.670	10.655.910	10.655.920	10.655.930
300 Series Stainless Steels 304, 316, 17-4Ph	11.658.620	11.658.634/ 11.658.630	11.658.644/ 11.658.640	11.658.654/ 11.658.650	11.658.664/ 11.658.660	10.655.671	10.655.911	10.655.921	10.655.931
400 Series Stainless Steels Martensitic	11.658.620	11.658.634/ 11.658.630	11.658.644/ 11.658.640	11.658.654/ 11.658.650	11.658.664/ 11.658.660	10.655.671	10.655.912	10.655.922	10.655.932
Cast Iron Grey	11.658.624	11.658.634	11.658.644	11.658.654	11.658.664	10.655.671/ 10.655.670	10.655.912	10.655.922	10.655.932
Cast Iron Ductile/Nodular	11.658.624	11.658.634	11.658.644	11.658.654	11.658.664	10.655.671/ 10.655.670	10.655.911	10.655.921	10.655.931
Exotics Titanium, Inconel, etc.	11.658.620	11.658.634/ 11.658.630	11.658.644/ 11.658.640	11.658.654/ 11.658.650	11.658.664/ 11.658.660	10.655.671	10.655.913	10.655.923	10.655.933
Brass and Bronze	11.658.624	11.658.634	11.658.644	11.658.654	11.658.664	10.655.671	10.655.913	10.655.923	10.655.933
Aluminum and Non-Ferrous	11.658.624	11.658.634	11.658.644	11.658.654	11.658.664	10.655.671	10.655.913	10.655.923	10.655.933



SERIES 336 INDEXABLE CARBIDE INSERTS

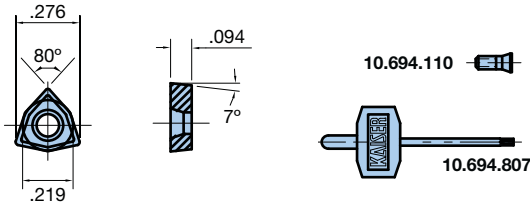

WC..03

Catalog Number	Designation	Rake Angle	Radius	Grade
11.658.620	WC033115C6TNP15	15°	0.031	TN15
11.658.624	WC033115C2P	15°	0.031	C2

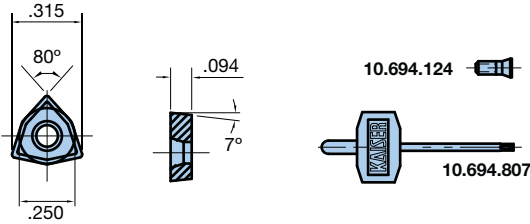

WC..04

Catalog Number	Designation	Rake Angle	Radius	Grade
11.658.630	WC043115C6TNP15	15°	0.031	TN15
11.658.634	WC043115C2P	15°	0.031	C2

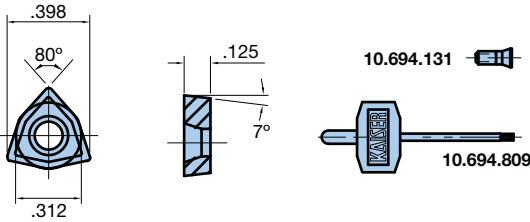

WC..05

Catalog Number	Designation	Rake Angle	Radius	Grade
11.658.640	WC053115C6TNP15	15°	0.031	TN15
11.658.644	WC053115C2P	15°	0.031	C2

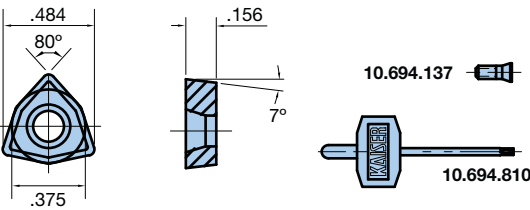

WC..06

Catalog Number	Designation	Rake Angle	Radius	Grade
11.658.650	WC063115C6TNP15	15°	0.031	TN15
11.658.654	WC063115C2P	15°	0.031	C2

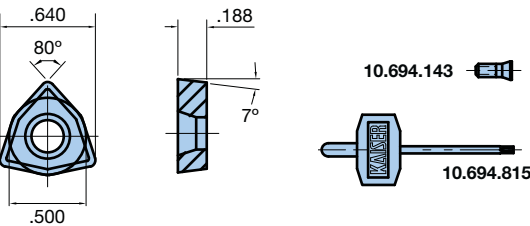

WC..08

Catalog Number	Designation	Rake Angle	Radius	Grade
11.658.660	WC084715C6TNP15	15°	0.047	TN15
11.658.664	WC084715C2P	15°	0.047	C2

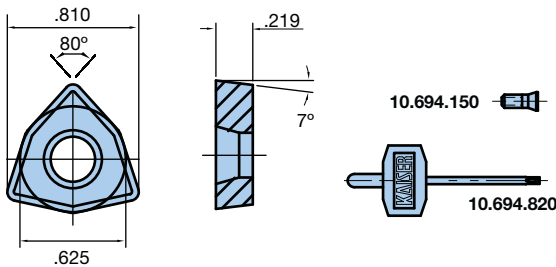

WC..10

Catalog Number	Designation	Rake Angle	Radius	Grade
10.655.670	WC104715C6TNP15	15°	0.047	TN15
10.655.671	WC104715C2P	15°	0.047	C2

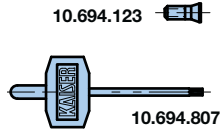
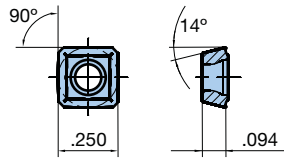

WP 337-1

Catalog Number	Designation	Rake Angle	Grade
10.655.910	WP 337-1 16/20	15°	TNP11
10.655.911	WP 337-1 16/20	15°	TNP12
10.655.912	WP 337-1 16/20	15°	TNP16
10.655.913	WP 337-1 16/20	15°	C2P

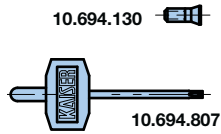
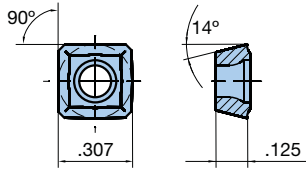

WP 337-2

Catalog Number	Designation	Rake Angle	Grade
10.655.920	WP 337-2 21/25	15°	TNP11
10.655.921	WP 337-2 21/25	15°	TNP12
10.655.922	WP 337-2 21/25	15°	TNP16
10.655.923	WP 337-2 21/25	15°	C2P

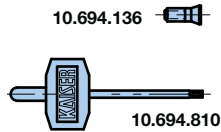
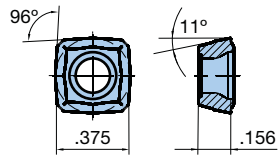

WP 337-3

Catalog Number	Designation	Rake Angle	Grade
10.655.930	WP 337-3 26/30	15°	TNP11
10.655.931	WP 337-3 26/30	15°	TNP12
10.655.932	WP 337-3 26/30	15°	TNP16
10.655.933	WP 337-3 26/30	15°	C2P



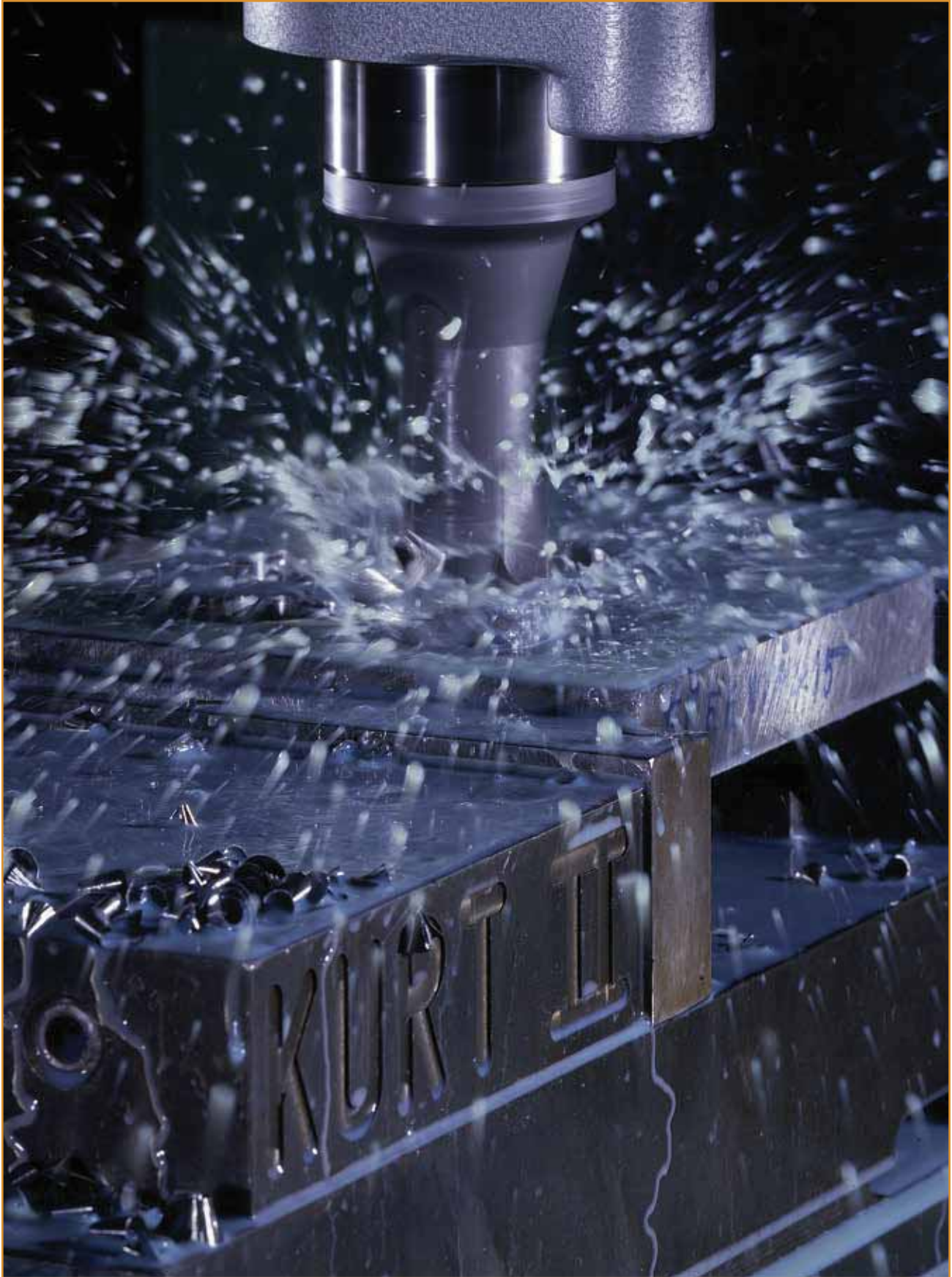

Cutting Data

Material	Cutting Speed SFM		Feed IPR				
	Coolant Delivery		Drill Diameter				
	Flood	Through Tool	≤ø.812	ø.845-1.000	ø1.031-1.188	ø1.219-1.688	ø1.750 & Over
Carbon Steel 10XX-15XX, 1018, 1212, 1551	250-400	575-800	.0020	.0040	.0050	.006	.0080
Alloy Steel 21XX-92XX, 4130, 4340, 8620	230-350	550-700	.0020	.0040	.0050	.006	.0080
300 Series Stainless Steel 304, 316, 17-4Ph	230-350	450-580	.0025	.0030	.0035	.004	.0045
400 Series Stainless Steel 410, 430	230-350	490-620	.0025	.0030	.0035	.004	.0045
Grey Cast Iron	250-360	600-750	.0040	.0055	.0060	.007	.0080
Ductile/Nodular Cast Iron	230-270	460-590	.0040	.0055	.0060	.007	.0080
Aluminum & Non-Ferrous	325-400	650-1150	.0060	.0085	.0085	.010	.0120

K Values

Carbon Steel	Alloy Steel	Stainless Steel	Grey Cast Iron	Ductile/Nodular Cast Iron	Aluminum & Non-Ferrous
1.6	1.3	1	1.7	1.5	3.4

$$hP = \frac{(.785)(D^2)(RPM)(IPR)}{K}$$

$$RPM = \frac{SFM \times 3.82}{\text{Drill } \phi}$$

$$IPM = RPM \times IPR$$

Horse Power Requirements

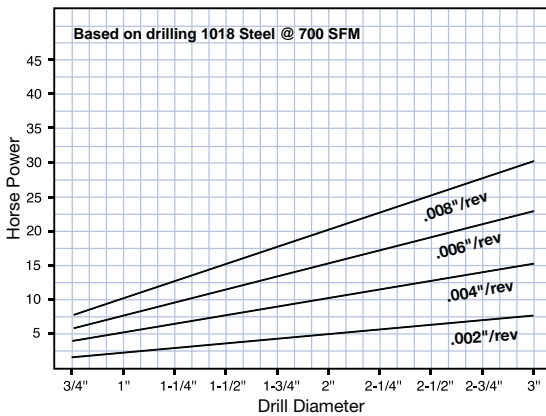

Thrust Requirements

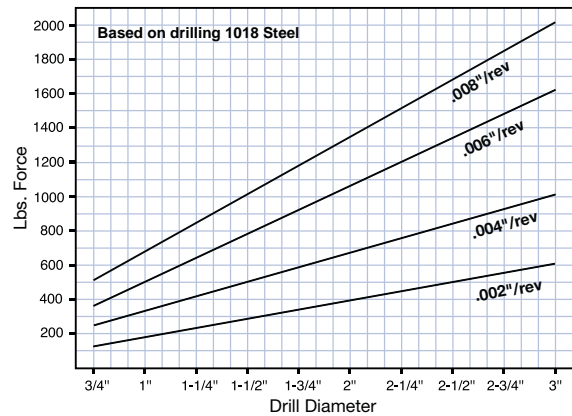

Coolant Requirements*

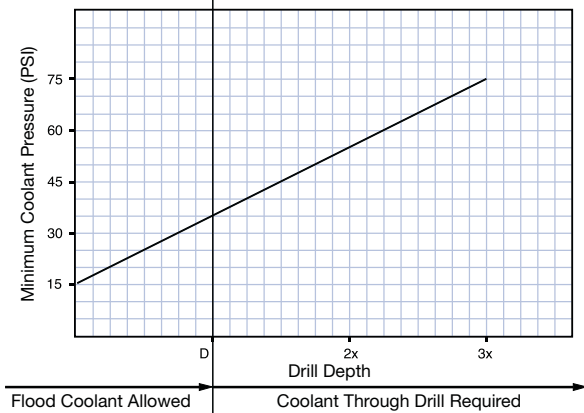

Coolant Volume*



*For coolant requirements and coolant volume, add 10-20% for vertical drilling operations

CAUTION ⚠

A disc is generated during through-boring operations. In case of rotating workpieces, there is an accident hazard due to the development of centrifugal force. Therefore, always work with safety guards.



SPADE DRILLS OVERVIEW



The KAISER Spade Drill Program

KAISER Spade Drills utilize the KAB modular tool system, a proven and effective connection providing the highest possible rigidity and accuracy. With today's emphasis in modern machine shops being placed on modular and semi-modular tooling, KAISER has taken the concept one step further by incorporating Spade Drill technology into the system. KAISER Spade Drills are high performance, high production drills, with production levels exceeding uncoated HSS drills by at least 50%.

Eight KAB6 holders are offered to cover a drilling range of $\phi.531$ "- 2.500 " in drill depths of 2-1/2x, 4x, and 6x drill diameter. Replaceable blades are offered in two grades, TiN coated, and ground to exact dimensions and tolerances on CNC equipment.

The KAB System

KAISER's KAB modular tool system allows for unique and versatile tool configurations in conjunction with Spade Drill use. Coolant induced, extended length and obsolete design shanks, along with extensions and reductions, can all be incorporated into the system to give users the best design possible for optimum tool rigidity and length. Our application engineers can assist with your application needs and can offer a complete tool drawing to show all pertinent information.

Blades

HSS grade can be used to cover up to 80% of all applications. Offered in drill diameters of $\phi.719$ "- 2.500 ", HSS blades are made from tough, fine grain tool steel (CPM-M4HSS) allowing them to be very forgiving in high production situations.

SC (Super Cobalt) grade contains a higher cobalt content to provide higher wear resistance when drilling materials such as alloy and high strength alloy steel, high temperature alloys, and structural steels whose hardness is Rc 25+. Consult our recommended speeds and feeds table for complete application guidelines.

Solid carbide (C2 and C5) grades are also available upon request for drill diameters of $\phi.531$ "- 1.375 " for applications requiring the highest wear resistance. Consult our engineering department for details and information.

Material	Material Hardness (BHN)	SFM	Feed (IPR)				
			.531"-.688"	.688"-1.000"	1.000"-1.250"	1.250"-2.000"	2.000"-2.500"
Free Machining Steel 1118, 1215, 12L14, etc.	100-150	200	.010	.013	.016	.020	.025
	150-200	180	.010	.013	.016	.020	.025
	200-250	160	.010	.013	.016	.020	.025
Low Carbon Steel 1010, 1020, 1025, 1522, 1144, etc.	85-125	170	.009	.012	.015	.020	.025
	125-175	160	.009	.012	.015	.020	.025
	175-225	150	.008	.010	.014	.018	.022
	225-275	140	.008	.010	.014	.018	.022
Medium Carbon Steel 1030, 1040, 1050, 1527, 1140, 1151, etc.	125-175	160	.009	.012	.015	.020	.025
	175-225	150	.008	.010	.014	.018	.022
	225-275	140	.008	.010	.014	.018	.022
	275-325*	130	.007	.009	.012	.016	.020
Alloy Steel 4140, 5140, 8640, etc.	125-175	150	.008	.010	.014	.017	.020
	175-225	140	.008	.010	.014	.017	.020
	225-275	130	.007	.010	.014	.017	.020
	275-325*	120	.006	.009	.012	.015	.018
	325-375*	110	.006	.009	.012	.015	.018
High Strength Alloy 4340, 4330V, 300M, etc.	225-300*	80	.007	.009	.010	.014	.018
	300-350*	60	.007	.009	.010	.014	.018
	350-400*	50	.006	.008	.009	.012	.016
Structural Steel A36, A285, A516, etc.	100-150	140	.010	.012	.014	.018	.022
	150-250	120	.009	.010	.012	.016	.020
	250-350*	100	.008	.009	.010	.014	.017
High Temp. Alloy Hastelloy B, Inconel 600, etc.	140-220*	30	.007	.008	.010	.012	.015
	220-310*	25	.006	.007	.080	.010	.012
Stainless Steel 310, 316, 330, 17-4 PH, etc.	135-185	75	.008	.009	.011	.014	.016
	185-275	60	.007	.008	.010	.012	.014
Tool Steel H-13, H-21, A-4, O-2, S-3, etc.	150-200	80	.006	.008	.010	.012	.015
	200-250	60	.006	.008	.010	.012	.015
Aluminum	30	600	.013	.016	.022	.030	.035
	180	300	.013	.016	.022	.030	.035
Cast Iron (TiN Coated HSS Tools)	120-150	170	.012	.016	.020	.024	.028
	150-200	150	.011	.014	.018	.022	.026
	200-220	130	.009	.012	.016	.018	.022
	220-260*	110	.007	.009	.012	.014	.017
	260-320*	90	.006	.007	.009	.011	.014

*SC grade recommended

- Reductions in speed may be required due to excessive tool wear
- Always use an ample supply of coolant through the tool

Formulas: $IPM = RPM \times IPR$ $SFM = \frac{RPM \times Drill \ \phi}{3.82}$ $RPM = \frac{SFM \times 3.82}{Drill \ \phi}$

The speeds and feeds listed above are only a starting point! Contact our engineering department if you require assistance. Please have item number, hole diameter, depth, material grade, BHN hardness and coolant pressure information available when you call. Additional information such as part and machine rigidity, horse power and thrust limits, vertical or horizontal spindle, revolving or stationary tool, flood or through holder coolant are also very helpful to our Application Engineers when you require their best recommendation.

The above recommendations are based on adequate coolant flow, machine rigidity, horse power and thrust capability.

Wear protective eye glasses and use machine protective shields.



SPADE DRILL HOLDERS & BLADES

+ .005
- .000

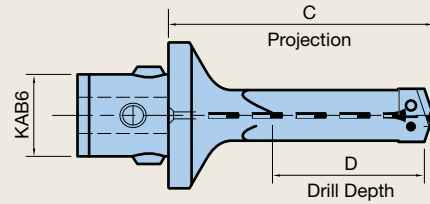
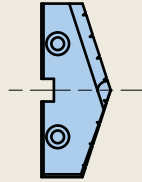

Drill Diameter	HSS Grade	SC Grade	2 1/2 x Diameter	±.016 C	D Max
.531	—	11.341.025	11.340.602 Designation KSD 0x13-17/39xKA6 Insert Screws 11.341.901	3.890	1.531
.562	—	11.341.026			
.594	—	11.341.027			
.625	—	11.341.028	11.340.612 Designation KSD 0.5x15-17/39xKA6 Insert Screws 11.341.902	3.890	1.531
.656	—	11.341.029			
.688	—	11.341.030			
.719	11.341.101	11.341.125	—	—	—
.750	11.341.102	11.341.126			
.781	11.341.103	11.341.127			
.812	11.341.104	11.341.128			
.844	11.341.105	11.341.129			
.875	11.341.106	11.341.130			
.906	11.341.107	11.341.131	11.340.632 Designation KSD 1.5x22-24/52xKA6 Insert Screws 11.341.904	4.550	2.062
.934	11.341.108	11.341.132			
1.000	11.341.202	11.341.226	11.340.642 Designation KSD 2x25-35/75xKA6 Insert Screws 11.341.905	5.430	2.938
1.062	11.341.204	11.341.228			
1.125	11.341.206	11.341.230			
1.188	11.341.208	11.341.232	11.340.652 Designation KSD 2.5x30-35/75xKA6 Insert Screws 11.341.905	5.430	2.938
1.250	11.341.210	11.341.234			
1.312	11.341.212	11.341.236			
1.375	11.341.214	11.341.238			
1.438	11.341.302	11.341.326			
1.500	11.341.304	11.341.328			
1.562	11.341.306	11.341.330	N/A	—	—
1.625	11.341.308	11.341.332			
1.688	11.341.310	11.341.334			
1.750	11.341.312	11.341.336			
1.812	11.341.314	11.341.338			
1.875	11.341.316	11.341.340			
2.000	11.341.404	11.341.428	N/A	—	—
2.125	11.341.408	11.341.432			
2.250	11.341.412	11.341.436			
2.375	11.341.416	11.341.440			
2.500	11.341.420	11.341.444			

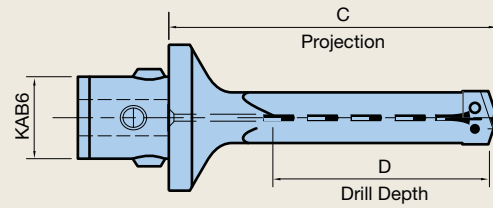
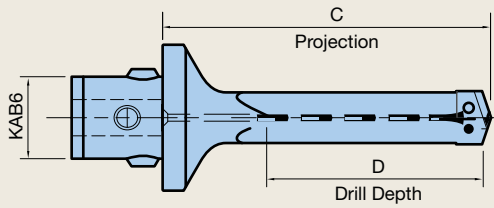

	4 x Diameter	±.016 C	D Max	6 x Diameter	±.016 C	D Max
	11.340.604 Designation KSD 0x13-17/62xKA6 Insert Screw 11.341.901	4.790	2.438	N/A	—	—
	11.340.614 Designation KSD 0.5x15-17/62xKA6 Insert Screws 11.341.902	4.790	2.438	N/A	—	—
	11.340.624 Designation KSD 1x18-24/84xKA6 Insert Screws 11.341.902	5.800	3.312	N/A	—	—
	11.340.634 Designation KSD 1.5x22-24/84xKA6 Insert Screws 11.341.904	5.800	3.312	N/A	—	—
	11.340.644 Designation KSD 2x25-35/119xKA6 Insert Screws 11.341.905	7.180	4.688	N/A	—	—
	11.340.654 Designation KSD 2.5x30-35/119xKA6 Insert Screws 11.341.905	7.180	4.688	N/A	—	—
	11.340.664 Designation KSD 3x36-47/167xKA6 Insert Screws 11.341.906	9.650	6.562	11.340.665 Designation KSD 3x36-47/210xKA6	11.086	8.250
	11.340.674 Designation KSD 4x48-65/227xKA6 Insert Screws 11.341.906	12.060	8.938	N/A	—	—



Twin Cutter Rough Boring Heads Series 319 & 315 – Boring Range ϕ .787"-8.000" (ϕ 20mm-203mm)

KAISER 319 and 315 twin cutter boring heads are designed for heavy duty rough boring and semi-finishing operations. Their compact, sturdy design and positive geometry allow almost chatter free operation even in interrupted cuts and high cutting speeds. Twin cutter boring heads can outperform single cutter finishing heads by a factor of up to 4 times. Large stock allowances and high feed rates permit high production while assuring optimum bore roundness and location, two important quality features for today's tighter control of part geometry. In many cases, these tools can eliminate the need for semi-finishing cuts due to the superb balance of cutting forces, even under the most severe casting core shift.

KAISER 319 and 315 series tools use ISO standard inserts with positive cutting geometry for reduced cutting forces. The top clamp-free mounting of the insert holders and wide open chip spaces between them allows perfect chip formation and evacuation. Different grades and geometry's of carbide and silicon nitride inserts are available to optimize all application criteria. Through spindle coolant capability is standard on all 319 and 315 heads.

Primary applications include:

- Castings, grey iron and steel
- Weldments
- Precision bore location and roundness
- Forgings
- Ideal alternative to circular milling

Twin cutter bore tolerances: .004" (.10mm) with tool presetter

Repeatability of bore size: .0002" (.005mm) w/out insert wear

Location of bore and roundness: .0005" (.012mm)

- Tolerances, location, and roundness all assume rigid machine tool and workpiece



Series 319 "SW" Twin Cutter Boring Heads

Boring Range: ϕ .787"-8.000" (ϕ 20mm-203mm) Pg. 40-44
 The new Series 319 "SW" heads were designed with ultimate performance and versatility in mind. These heads can perform balanced or stepped cutting without additional accessories or adjustments simply by switching the mounting locations of the insert holders that have varied heights.



Series 315 "TWN" Twin Cutter Boring Heads

Boring Range: ϕ .787"-8.000" (ϕ 20mm-203mm) Pg. 45-47
 "TWN" roughing heads are ideal for heavy duty, economical rough boring for most applications without height adjustment. They offer a setting scale for coarse diameter adjustment and adjustable coolant ports (ϕ 2.087" and larger).

Insert Selection & Cutting Data Pg. 48-49
Guidelines & Troubleshooting Pg. 50-51

Roughing

Insert Holders: Type CC
 RSS*, $\phi.787''-8.000''$
 High feed rates

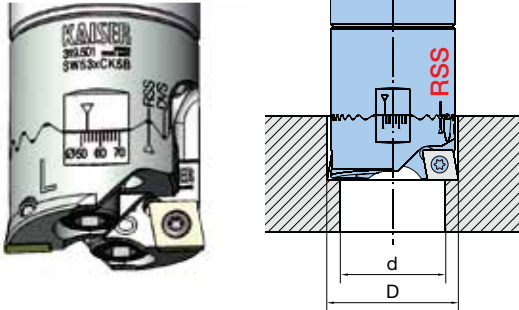

Insert Holders: Type CC
 DVS*, $\phi.787''-8.000''$
 Double stock removal, half the feed rate

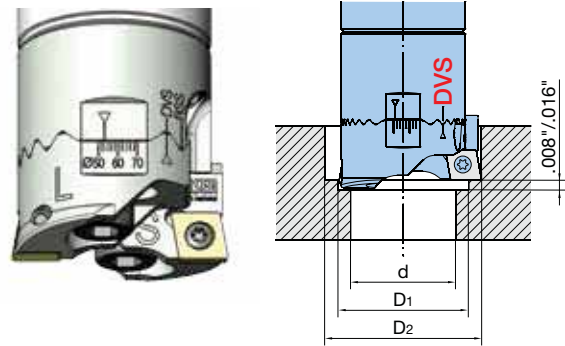

Insert Holders: Type SP/SC
 RSS*, $\phi.787''-8.000''$
 4 cutting edges, lead angle 6°

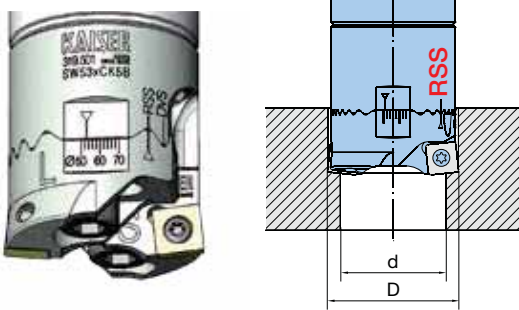

***RSS: Balanced Cutting**
***DVS: Stepped Cutting**

Chamfering

$\phi 1.535''-8.268''$ (45°)
 Adjustable chamfer angle $15^\circ-75^\circ$

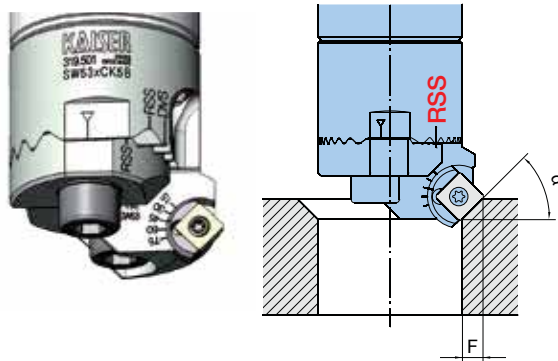

Back Boring

$\phi 1.732''-8.307''$
 Lead angle 90°

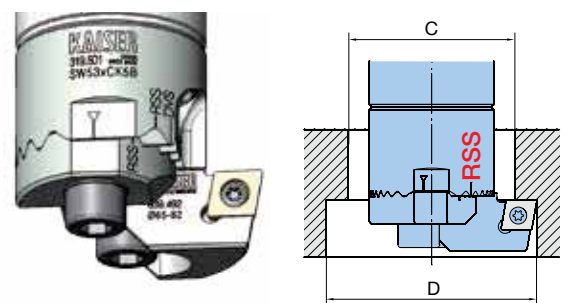

SERIES 319 SW \varnothing .787"-8.000"

U.S. PATENT
8,747,034

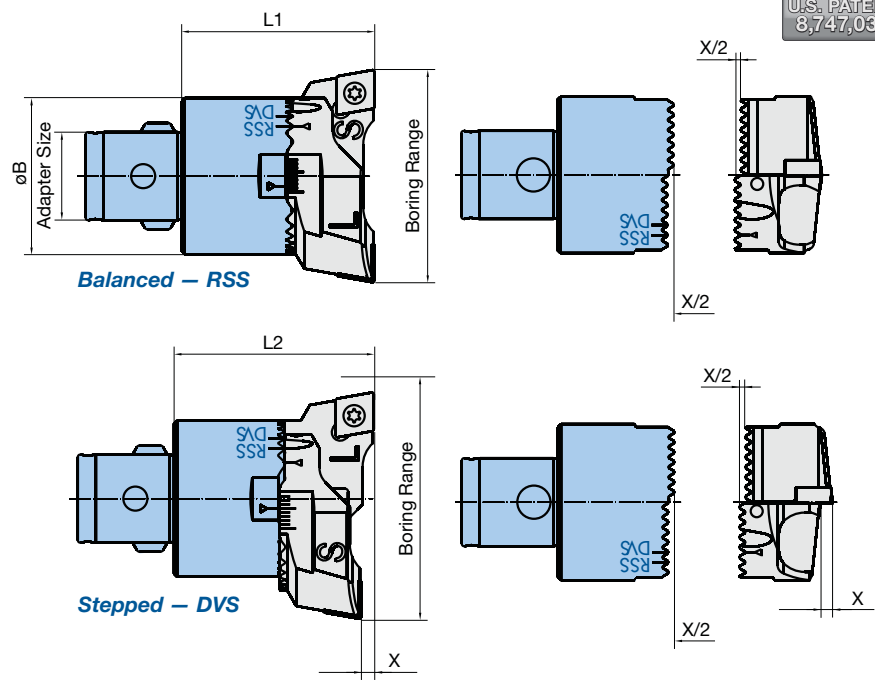

KAB Boring Heads

Head Type	Adapter Size	Catalog Number	Boring Range		oB	L1	L2	X (Step)
			Min	Max				
SW20	KAB1	10.319.101	.787	1.220	.748	1.280	1.284	.008
SW25	KAB2	10.319.201	.984	1.575	.945	1.398	1.402	
SW32	KAB3	10.319.301	1.260	2.008	1.220	1.575	1.579	
SW41	KAB4	10.319.401	1.614	2.598	1.535	1.850	1.858	.016
SW53	KAB5	10.319.501	2.087	3.386	1.969	2.244	2.252	
SW68	KAB6	10.319.601	2.677	4.331	2.500	2.795	2.803	
SW98	KAB6	10.319.602	3.858	6.024	3.543	2.795	2.803	
SW148	KAB6	10.319.603	5.827	8.000	5.512	2.795	2.803	
SW98	KAB7	10.319.701	3.858	6.024	3.543	3.425	3.433	
SW98L	KAB7	10.319.702	3.858	6.024	3.543	4.606	4.614	
SW148	KAB7	10.319.703	5.827	8.000	5.512	4.606	4.614	

SPARE PARTS
PG. 41

CKN Boring Heads

Head Type	Adapter Size	Catalog Number	Boring Range		oB	L1	L2	X (Step)
			Min	Max				
SW68	CKN6	10.319.601N	2.677	4.331	2.500	2.795	2.803	.016
SW98	CKN6	10.319.602N	3.858	6.024	3.543	2.795	2.803	
SW148	CKN6	10.319.603N	5.827	8.000	5.512	2.795	2.803	
SW98	CKN7	10.319.701N	3.858	6.024	3.543	3.425	3.433	
SW98L	CKN7	10.319.702N	3.858	6.024	3.543	4.606	4.614	
SW148	CKN7	10.319.703N	5.827	8.000	5.512	4.606	4.614	

SPARE PARTS
PG. 41

AVAILABLE IN
 ALUMINUM

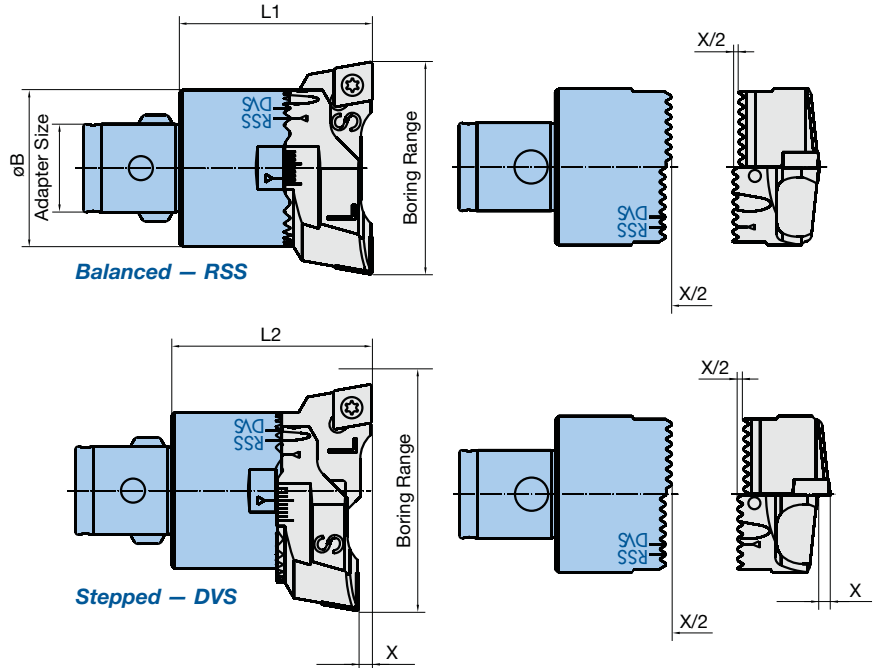

CKN Boring Heads – Aluminum

Head Type	Adapter Size	Catalog Number	Boring Range		L1 (RSS)	L2 (DVS)	A	X (DVS)	B1	B2	C
			Min	Max							
SW68 AL	CKN6	319.604N	2.677	4.331	2.795	2.803	2.500	.016	1.555	1.547	1.575
SW98 AL	CKN6	319.605N	3.858	6.024	2.795	2.803	3.543		1.457	1.449	
SW148 AL	CKN6	319.607N	5.827	7.992	2.795	2.803	5.512		1.457	1.449	
SW98 AL	CKN7	319.705N	3.858	6.024	3.425	3.433	3.543		2.087	2.079	1.969
SW98L AL	CKN7	319.706N*	3.858	6.024	4.606	4.614	3.543		3.268	3.260	
SW148 AL	CKN7	319.707N	5.827	8.000	4.606	4.614	5.512		3.268	3.260	

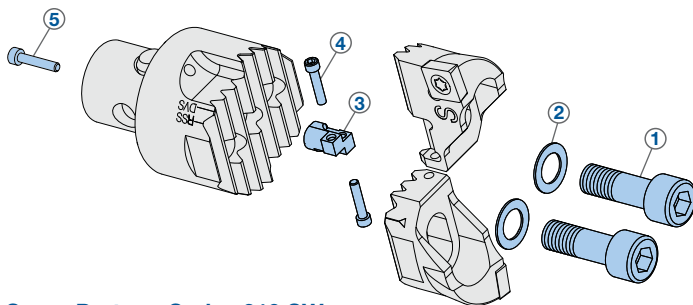

Spare Parts – Series 319 SW

Head Type	① Clamping Screw	② Washer	Torque (ft.-lbs.)	Clamping Screw Wrench	Coolant Port	③ Adjusting Housing	④ Adjusting Screw	Adjusting Screw Wrench	⑤ Housing Screw
SW20	10.690.188	10.693.175	3	10.690.803	—	10.319.150	10.690.191	10.690.819	10.690.184
SW25	10.690.157	10.693.176	5	10.690.804	—	10.319.250	10.690.192	10.690.819	10.690.186
SW32	10.690.108	10.693.177	9	10.690.805	—	10.319.350	10.690.193	10.690.811	10.690.189
SW41	10.690.163	10.693.178	18	10.690.806	—	10.319.450	10.690.194	10.690.812	10.690.189
SW53	10.690.105	10.693.179	44	10.690.807	10.692.409	10.319.550	10.690.195	10.690.812	10.690.189
SW68	10.690.106	10.693.179	44	10.690.807	10.692.406	10.319.650	10.690.196	10.690.813	10.690.101
SW98/148	10.690.970	10.693.187	59	10.690.810	10.692.406	10.319.750	10.690.197	10.690.814	10.690.108*

*For KAB7/CKN7 heads, use 10.690.173

SERIES 319 SW INSERT HOLDERS

CC Insert Holders (Sold in Pairs)

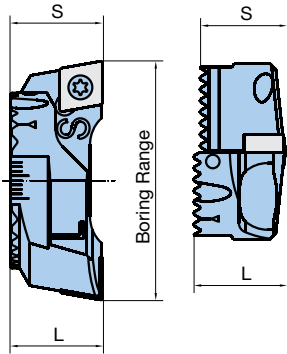

Head Type	Catalog Number	Boring Range		S	L	Insert	Insert Screw	Insert Screw Wrench
		Min	Max					
SW20	10.639.413	.787	1.024	.520	.524	CC..06	10.694.122	10.694.807
	10.639.417	.984	1.220	.520	.524			
SW25	10.639.423	.984	1.299	.591	.595	CC..06	10.694.122	10.694.807
	10.639.427	1.260	1.575	.591	.595			
SW32	10.639.433	1.260	1.654	.736	.740	CC..09	10.694.141	10.694.815
	10.639.437	1.614	2.008	.736	.740			
SW41	10.639.443	1.614	2.126	.795	.803	CC..09	10.694.141	10.694.815
	10.639.447	2.087	2.598	.795	.803			
SW53	10.639.453	2.087	2.756	1.079	1.087	CC..12	10.694.150	10.694.820
	10.639.457	2.717	3.386	1.079	1.087			
SW68	10.639.463	2.677	3.543	1.374	1.382	CC..12	10.694.150	10.694.820
	10.639.467	3.465	4.331	1.374	1.382			
SW98	10.639.473	3.858	4.961	1.472	1.480	CC..12	10.694.150	10.694.820
	10.639.477	4.921	6.024	1.472	1.480			
SW148	10.639.483	5.827	6.929	1.472	1.480	CC..12	10.694.150	10.694.820
	10.639.487	6.890	8.000	1.472	1.480			

Additional Insert Holders – CC..16

SW68	10.639.563	2.677	3.543	1.374	1.382	CC..16	10.694.150	10.694.820
	10.639.567	3.465	4.331	1.374	1.382			
SW98	10.639.573	3.858	4.961	1.472	1.480	CC..16	10.694.150	10.694.820
	10.639.577	4.921	6.024	1.472	1.480			
SW148	10.639.583	5.827	6.929	1.472	1.480	CC..16	10.694.150	10.694.820
	10.639.587	6.890	8.000	1.472	1.480			

SP & SC Insert Holders (Sold in Pairs)

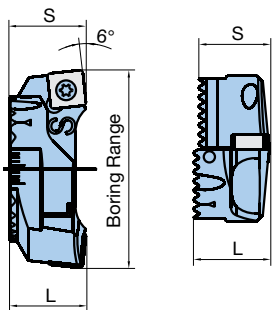

Head Type	Catalog Number	Boring Range		S	L	Insert	Insert Screw	Insert Screw Wrench
		Min	Max					
SW20	10.639.113	.787	1.024	.520	.524	SP..06	10.694.122	10.694.807
SW25	10.639.123	.984	1.299	.591	.595	SP..06	10.694.122	10.694.807
SW32	10.639.133	1.260	1.654	.736	.740	SC..09	10.694.141	10.694.815
	10.639.137	1.614	2.008	.736	.740			
SW41	10.639.143	1.614	2.126	.795	.803	SC..09	10.694.141	10.694.815
	10.639.147	2.087	2.598	.795	.803			
SW53	10.639.153	2.087	2.756	1.079	1.087	SC..12	10.694.150	10.694.820
	10.639.157	2.717	3.386	1.079	1.087			
SW68	10.639.163	2.677	3.543	1.374	1.382	SC..12	10.694.150	10.694.820
	10.639.167	3.465	4.331	1.374	1.382			
SW98	10.639.173	3.858	4.961	1.472	1.480	SC..12	10.694.150	10.694.820
	10.639.177	4.921	6.024	1.472	1.480			
SW148	10.639.183	5.827	6.929	1.472	1.480	SC..12	10.694.150	10.694.820
	10.639.187	6.890	8.000	1.472	1.480			

SERIES 319 SW CHAMFERING INSERT HOLDERS

These insert holders are made for front and back chamfering on the twin cutter roughing heads Series 319 SW41-SW148 and cover the diameter range $\phi 1.299$ "-8.268". The desired chamfering angle is adjustable from 15°-75°. The set contains one insert holder and one blank piece.

NEW!

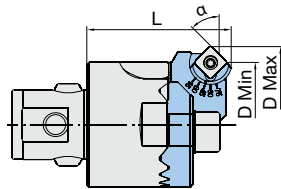
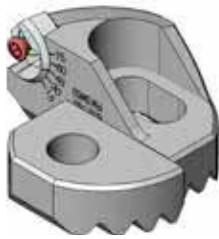

Boring Head	Catalog Number	Insert	15°		30°		45°		60°		75°		L 45° (RSS)
			D Min	D Max	D Min	D Max	D Min	D Max	D Min	D Max	D Min	D Max	
SW41	10.639.104	SC..09	1.850	2.362	1.929	2.441	1.968	2.480	1.968	2.480	1.929	2.441	2.008
SW53	10.639.105	SC..09	2.323	2.992	2.402	3.071	2.441	3.110	2.441	3.110	2.402	3.071	2.283
SW68	10.639.106	SC..09	2.953	3.819	3.032	3.898	3.071	3.937	3.071	3.937	3.032	3.898	2.677
SW98 (KAB6/CKN6)	10.639.107	SC..12	3.858	4.961	3.936	5.039	3.976	5.079	3.936	5.039	3.897	5.000	2.874
	10.639.108	SC..12	4.921	6.024	4.999	6.102	5.039	6.142	4.999	6.102	4.960	6.063	
SW148 (KAB6/CKN6)	10.639.109	SC..12	5.984	7.087	6.062	7.165	6.102	7.205	6.062	7.165	6.023	7.126	
	10.639.110	SC..12	7.047	8.150	7.125	8.228	7.165	8.268	7.125	8.228	7.086	8.189	
SW98 (KAB7/CKN7)	10.639.107	SC..12	3.858	4.961	3.936	5.039	3.976	5.079	3.936	5.039	3.897	5.000	3.504/ 4.685*
	10.639.108	SC..12	4.921	6.024	4.999	6.102	5.039	6.142	4.999	6.102	4.960	6.063	
SW148 (KAB7/CKN7)	10.639.109	SC..12	5.984	7.087	6.062	7.165	6.102	7.205	6.062	7.165	6.023	7.126	
	10.639.110	SC..12	7.047	8.150	7.125	8.228	7.165	8.268	7.125	8.228	7.086	8.189	

*With SW98L x KAB7/CKN7

Radial Chamfer Length for Front (F1) and Back (F2) Chamfering

Applicable for inserts with .016" nose radius.

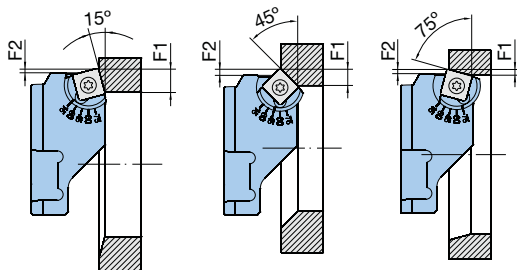

Head Type	Insert	Chamfer Angle									
		15°		30°		45°		60°		75°	
		F1 Max	F2 Max	F1 Max	F2 Max	F1 Max	F2 Max	F1 Max	F2 Max	F1 Max	F2 Max
SW41	SC..09	.303	.028	.272	.055	.224	.071	.157	.067	.083	.047
SW53											
SW68											
SW98	SC..12	.417	.047	.374	.087	.307	.102	.217	.098	.110	.071
SW148											

Spare Parts

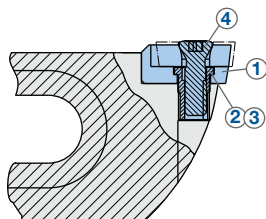

Head Type	① Pocket	② Screw	③ Wrench	Insert	④ Pin	Torque (ft-lbs.)
SW41	10.695.101	10.691.756	10.690.899	SC..09	10.694.138	2.2
SW53	10.695.101	10.691.756	10.690.899		10.694.138	
SW68	10.695.101	10.691.755	10.690.899		10.694.138	
SW98	10.695.102	10.691.757	10.690.804	SC..12	10.694.145	2.2
	10.695.102	10.691.757	10.690.804		10.694.145	
SW148	10.695.102	10.691.757	10.690.804		10.694.145	
	10.695.102	10.691.757	10.690.804		10.694.145	

SERIES 319 SW BACK BORING INSERT HOLDERS

These insert holders are made for back boring with the twin cutter rough boring heads Series 319 SW32-SW148 and cover the diameter range from $\phi 1.732$ "-8.307". The set contains one insert holder and one blank piece.

NEW!

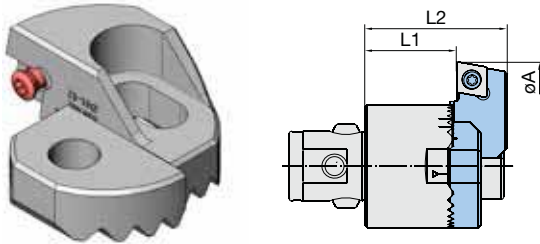

Boring Head	Catalog Number	ϕA		B	L1 (RSS)	L2 (RSS)	Insert
		Min	Max				
SW32	10.639.403	1.732	2.126	1.220	.945	1.496	CC..09
SW41	10.639.404	2.087	2.598	1.535	1.142	1.732	
SW53	10.639.405	2.559	3.228	1.969	1.339	2.165	
SW68	10.639.406	3.189	4.055	2.500	1.614	2.598	
SW98 (KAB6/CKN6)	10.639.407	4.016	5.118	3.543	1.496	2.717	
	10.639.408	5.079	6.181				
SW148 (KAB6/CKN6)	10.639.409	6.142	7.244	5.512			CC..12
	10.639.410	7.205	8.307				
SW98 (KAB7/CKN7)	10.639.407	4.016	5.118	3.543	1.850/3.031*	3.071/4.252*	
	10.639.408	5.079	6.181				
SW148 (KAB7/CKN7)	10.639.409	6.142	7.244	5.512	3.031	4.252	
	10.639.410	7.205	8.307				

*With SW98L x KAB7/CKN7

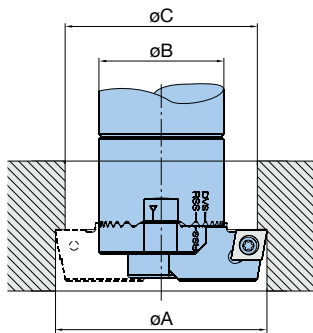

Back Bore & Entry Bore Diameters

Maximum Back Bore Diameter "A"	$A \text{ Max} = (2 \times C) - B$
Maximum Body Diameter "B"	$B \text{ Max} = (2 \times C) - A$
Minimum Entry Bore Diameter "C"	$C \text{ Min} = (A+B)/2$

Program "TWN" – No Variable Insert Height

- Diameter range of ϕ .787"-8.000" (ϕ 20mm-203mm)
- High stability and rigid tool assembly for large stock allowances and feed rates
- Coolant through standard with directional coolant ports

U.S. PATENT
6,183,174

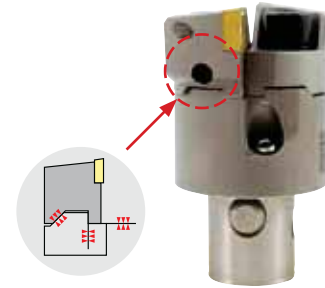
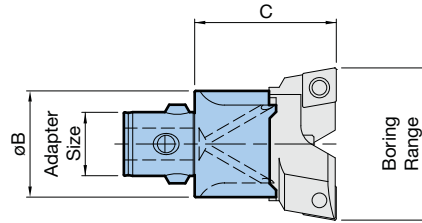

Precision Ground Mating Surfaces

KAB Boring Heads

Head Type	Adapter Size	Catalog Number	Boring Range		øB	C
			Min	Max		
TWN20	KAB1	10.315.101	.787	1.220	.728	1.280
TWN25	KAB2	10.315.201	.984	1.575	.921	1.398
TWN32	KAB3	10.315.301	1.260	2.008	1.181	1.575
TWN41	KAB4	10.315.401	1.614	2.598	1.535	1.850
TWN53	KAB5	10.315.501	2.087	3.386	1.929	2.244
TWN68	KAB6	10.315.601	2.677	4.331	2.480	2.795
TWN98	KAB6	10.315.602	3.858	6.024	3.543	2.795
TWN148	KAB6	10.315.603	5.827	8.000	5.512	2.795
TWN98	KAB7	10.315.701	3.858	6.024	3.543	3.425
TWN98L	KAB7	10.315.702	3.858	6.024	3.543	4.606
TWN148	KAB7	10.315.703	5.827	8.000	5.512	4.606

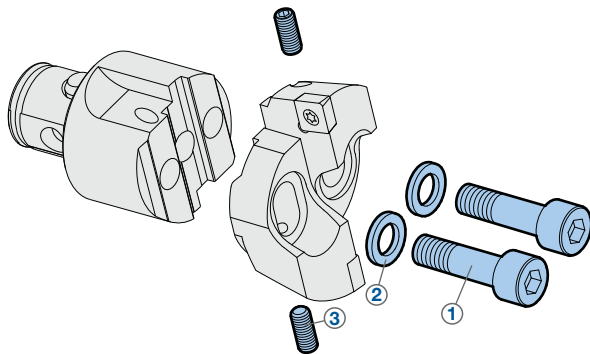

Spare Parts – Series 315 TWN

Head Type	① Clamping Screw		Clamping Screw Wrench	② Washer	③ Adjusting Screw	
	Catalog Number	Torque (ft-lbs)			Catalog Number	Torque (in-lbs)
TW20	10.315.160	3	10.690.803	10.693.180	10.690.529	1.5
TW25	10.315.250	5	10.690.804	10.693.181	10.690.538	1.8
TW32	10.315.350	9	10.690.805	10.693.182	10.690.426	3
TW41	10.315.450	22	10.690.806	10.693.183	10.690.537	7
TW53	10.315.550	44	10.690.807	10.693.184	10.690.586	13
TW68	10.315.650	44	10.690.807	10.693.184	10.690.584/587	18
TW98	10.315.750	59	10.690.810	10.693.185	10.690.585/588	18
TW148	10.315.750	59	10.690.810	10.693.185	10.690.585/588	18

SERIES 315 TWN INSERT HOLDERS

CC Insert Holders (Sold in Pairs)

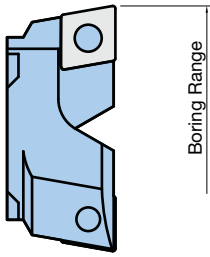

Head Type	Insert Holder Size	Catalog Number	Boring Range		Insert	Insert Screw	Insert Screw Wrench
			Min	Max			
TW20	11	10.638.411	.787	1.024	CC..06	10.694.122	10.694.807
	12	10.638.412	.984	1.220			
TW25	21	10.638.421	.984	1.300	CC..06	10.694.122	10.694.807
	22	10.638.422	1.260	1.575			
TW32	31	10.638.431	1.260	1.654	CC..09	10.694.141	10.694.815
	32	10.638.432	1.614	2.008			
TW41	41	10.638.441	1.614	2.126	CC..09	10.694.141	10.694.815
	42	10.638.442	2.087	2.598			
TW53	51	10.638.451	2.087	2.756	CC..12	10.694.150	10.694.820
	52	10.638.452	2.717	3.386			
TW68	61	10.638.461	2.677	3.543	CC..12	10.694.150	10.694.820
	62	10.638.462	3.465	4.331			
TW98	71	10.638.471	3.858	4.961	CC..12	10.694.150	10.694.820
	72	10.638.472	4.921	6.024			
TW148	71	10.638.471	5.827	6.929	CC..12	10.694.150	10.694.820
	72	10.638.472	6.890	8.000			

Additional Insert Holders - CC16

TW68	61	10.638.561	2.677	3.543	CC..16	10.694.150	10.694.820
	62	10.638.562	3.465	4.331			
TW98	71	10.638.571	3.858	4.961	CC..16	10.694.150	10.694.820
	72	10.638.572	4.921	6.024			
TW148	71	10.638.571	5.827	6.929	CC..16	10.694.150	10.694.820
	72	10.638.572	6.890	8.000			

SP & SC Insert Holders (Sold in Pairs)

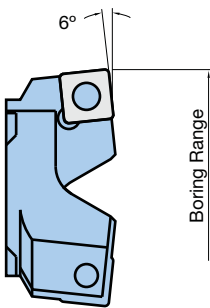

Head Type	Insert Holder Size	Catalog Number	Boring Range		Insert	Insert Screw	Insert Screw Wrench
			Min	Max			
TW20	11	10.638.111	.787	1.024	SP..06	10.694.122	10.694.807
TW25	21	10.638.121	.984	1.300	SP..06	10.694.122	10.694.807
TW32	31	10.638.131	1.260	1.654	SC..09	10.694.141	10.694.815
	32	10.638.132	1.614	2.008			
TW41	41	10.638.141	1.614	2.126	SC..09	10.694.141	10.694.815
	42	10.638.142	2.087	2.598			
TW53	51	10.638.151	2.087	2.756	SC..12	10.694.150	10.694.820
	52	10.638.152	2.717	3.386			
TW68	61	10.638.161	2.677	3.543	SC..12	10.694.150	10.694.820
	62	10.638.162	3.465	4.331			
TW98	71	10.638.171	3.858	4.961	SC..12	10.694.150	10.694.820
	72	10.638.172	4.921	6.024			
TW148	71	10.638.171	5.827	6.929	SC..12	10.694.150	10.694.820
	72	10.638.172	6.890	8.000			

WC Insert Holders (Sold in Pairs)

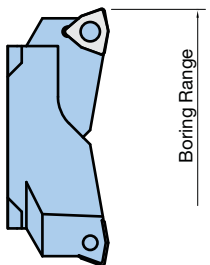

Head Type	Insert Holder Size	Catalog Number	Boring Range		Insert	Insert Screw	Insert Screw Wrench
			Min	Max			
TW53	51	10.638.251	2.323	2.992	WC..05	10.694.131	10.694.809
	52	10.638.252	2.717	3.386			
TW68	61	10.638.261	2.874	3.740	WC..06	10.694.137	10.694.810
	62	10.638.262	3.543	4.409			
TW98	71	10.638.271	4.173	5.276	WC..06	10.694.137	10.694.810
	72	10.638.272	5.157	6.260			
TW148	71	10.638.271	6.142	7.244	WC..06	10.694.137	10.694.810
	72	10.638.272	7.126	8.228			

• Full profile roughing only — height adjustment not required

The 315 program back boring insert holders attach to KA3-KA6 rough boring heads and compliment the back boring capabilities of the 310 finish boring program.

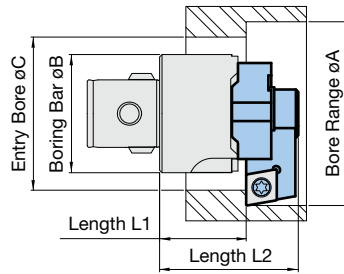
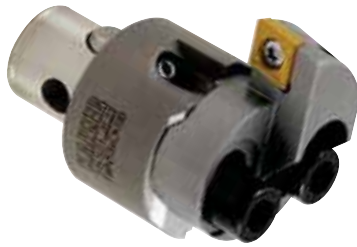

Back Bore & Entry Bore Diameters

Maximum Body Diameter 'A'	$A_{max} = (2 \times C) - D$
Maximum Back Bore Diameter 'D'	$D_{max} = (2 \times C) - A$
Minimum Entry Bore Diameter 'C'	$C_{min} = (D + A) / 2$

Back Boring Insert Holders

Head Type	Insert Holder Size	Catalog Number	Boring Range		Insert	Insert Screw	A	Length L1	Length L2
			Min	Max					
TW32	31	11.689.903*	1.260	1.654	CC..09	10.694.141	1.181	.984	1.516
	32	11.689.904	1.614	2.008					
TW41	41	11.689.905	1.614	2.126	CC..09	10.694.141	1.535	1.142	1.772
	42	11.689.906	2.087	2.598					
TW53	51	11.689.907	2.087	2.756	CC..12	10.694.150	1.929	1.417	2.220
	52	11.689.908	2.717	3.386					
TW68	61	11.689.909	2.677	3.543	CC..12	10.694.150	2.480	1.772	2.795
	62	11.689.910	3.465	4.331**					

*Non-stock standard

**Maximum of ø5.669" with one set of cap screws (requires 10.690.471 set screw)

These insert holders are made for front chamfering on the twin cutter boring heads TW41-TW148 and cover the diameter range from ø1.693"-8.190". The desired chamfering angle is adjustable from 15° to 75°. Sold individually.

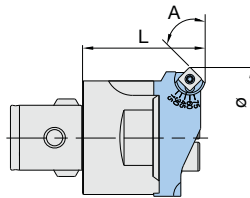

Chamfering Insert Holders with Adjustable Chamfering Angle

Head Type	Catalog Number	Insert	A = 15°		A = 30°		A = 45°		A = 60°		A = 75°		L (45°)
			ø Min	ø Max	ø Min	ø Max	ø Min	ø Max	ø Min	ø Max	ø Min	ø Max	
TW41	10.638.104	SC..09	1.693	2.205	1.732	2.244	1.772	2.283	1.772	2.283	1.732	2.244	2.008
TW53	10.638.105	SC..09	2.244	2.913	2.283	2.953	2.283	2.953	2.283	2.953	2.283	2.953	2.283
TW68	10.638.106	SC..09	2.913	3.780	2.953	3.819	2.992	3.858	2.992	3.858	2.953	3.819	2.677
TW98	10.638.107	SC..12	3.858	4.916	3.858	4.961	3.937	5.039	3.937	5.039	3.898	5.000	2.913 (KA6)
TW98	10.638.108	SC..12	5.000	6.102	5.079	6.181	5.118	6.220	5.118	6.220	5.079	6.181	3.543 (KA7)
TW148	10.638.107	SC..12	5.787	6.890	5.827	6.929	5.906	7.008	5.906	7.008	5.866	6.969	2.913 (KA6)
TW148	10.638.108	SC..12	6.969	8.071	7.008	8.110	7.087	8.190	7.087	8.190	7.008	8.110	4.724 (KA7)
Radial Chamfer Length		SC..09	.301		.270		.221		.156		.081		
		SC..12	.422		.378		.309		.219		.113		

ROUGH BORING INSERT SELECTION & CUTTING DATA

Recommended Inserts & Cutting Data for Rough Boring Under Optimal Conditions

- Rigid fixturing and workpiece
- Good machine spindle with adequate hp and thrust
- Setup not chatter prone



Material	Nose Radius	CC..06 (1/4" I.C.)						CC..09 (3/8" I.C.)				CC..12 (1/2" I.C.)					
		Catalog Number	Balanced Cutting		Step Cutting		Catalog Number	Balanced Cutting		Step Cutting		Catalog Number	Balanced Cutting		Step Cutting		
			Feed (IPR)	Max ø D.O.C.	Feed (IPR)	Max ø D.O.C.		Feed (IPR)	Max ø D.O.C.	Feed (IPR)	Max ø D.O.C.		Feed (IPR)	Max ø D.O.C.	Feed (IPR)		Max ø D.O.C.
Mild Steels 10XX-15XX 1018, 1020, 1551	.016	11.654.850	.012	.200	.006	.300	11.654.940	.014	.300	.008	.500	11.654.993	.014	.350	.008	.600	
	.031	11.654.860	.014	.200	.007	.300	11.654.952	.018	.300	.010	.500	11.654.990	.020	.400	.012	.800	
High Carbon Alloy Steels 23XX-92XX 4130, 4340, 8620	.016	11.654.850	.010	.200	.005	.300	11.654.940	.012	.300	.006	.500	11.654.993	.012	.350	.008	.600	
	.031	11.654.860	.012	.200	.006	.300	11.654.952	.016	.300	.008	.500	11.654.990	.018	.400	.012	.800	
300 Series Stainless Steel 304, 316, 17-4ph	.016	11.654.853	.010	.170	.005	.250	11.654.943	.012	.250	.006	.450	—	—	—	—	—	
	.031	11.654.869	.012	.170	.006	.250	11.654.953	.016	.250	.008	.450	11.654.983	.018	.325	.010	.600	
400 Series Stainless Steel Martensitic	.016	11.654.850	.010	.200	.005	.300	11.654.940	.012	.300	.006	.500	11.654.993	.012	.350	.008	.600	
	.031	11.654.860	.012	.200	.006	.300	11.654.952	.016	.300	.008	.500	11.654.990	.018	.400	.012	.800	
Grey Cast Iron Class 30	.016	11.654.854	.012	.250	.006	.400	11.654.940	.014	.400	.008	.750	11.654.993	.014	.500	.008	.800	
	.031	11.654.860	.014	.250	.007	.400	11.654.956	.018	.400	.010	.750	11.654.971	.020	.600	.012	1.00	
Silicon Nitride	—	11.654.841	.010	.200	.005	.350	11.654.951	.016	.350	.008	.650	11.654.980	.018	.500	.010	.800	
Ductile/Nodular Cast Iron	.016	11.654.854	.010	.225	.005	.350	11.654.940	.012	.350	.006	.625	11.654.993	.012	.450	.008	.700	
	.031	11.654.860	.012	.225	.006	.350	11.654.956	.016	.350	.008	.625	11.654.971	.018	.500	.012	.900	
High Temp. Alloys Titanium, Inconel, Monel, etc.	.016	11.654.868	.008	.140	.004	.200	11.654.968	.010	.180	.005	.350	—	—	—	—	—	
	.031	—	—	—	—	—	11.654.969	.012	.200	.006	.400	11.654.978	.014	.280	.007	.500	
Brass and Bronze	.016	11.654.858	.012	.250	.006	.400	11.654.957	.014	.400	.008	.750	11.654.989	.014	.500	.008	.800	
	.031	11.654.864	.014	.250	.007	.400	11.654.958	.018	.400	.010	.750	11.654.991	.020	.600	.012	1.000	
Aluminum and Non-Ferrous	.016	10.654.888	.012	.300	.006	.500	10.654.977	.014	.500	.008	.900	10.654.995	.016	.550	.010	1.000	
	.031	11.654.898	.014	.300	.008	.500	10.654.987	.018	.500	.010	.900	10.654.992	.022	.650	.012	1.250	

Maximum cutting speed: 4,000 SFM

All cutting data without guarantee

Cutting Speed:

$$RPM = \frac{SFM \times 3.82}{Bore \phi}$$

Feed Rate:

$$IPM = RPM \times IPR$$



	CC..16 (5/8" I.C.)					SP..08 (5/16" I.C.)			SC..09 (3/8" I.C.)			SC..12/SD..12 (1/2" I.C.)			Speed (SFM)
	Catalog Number	Balanced Cutting		Step Cutting		Catalog Number	Balanced Cutting		Catalog Number	Balanced Cutting		Catalog Number	Balanced Cutting		
		Feed (IPR)	Max ϕ D.O.C.	Feed (IPR)	Max ϕ D.O.C.		Feed (IPR)	Max ϕ D.O.C.		Feed (IPR)	Max ϕ D.O.C.		Feed (IPR)	Max ϕ D.O.C.	
	—	—	—	—	—	10.654.183	.014	.175	11.654.240	.016	.280	11.654.340	.016	.350	850-1200
	11.654.996	.024	.600	.014	1.120	—	—	—	11.654.250	.020	.280	11.654.350	.022	.380	
	—	—	—	—	—	10.654.183	.012	.175	11.654.240	.014	.280	11.654.340	.014	.350	700-1000
	11.654.996	.022	.600	.012	1.120	—	—	—	11.654.250	.018	.280	11.654.350	.020	.380	
	—	—	—	—	—	10.654.183	.012	.125	11.654.247	.014	.230	—	—	—	375-600
	10.654.996	.022	.400	.012	.800	—	—	—	11.654.200	.018	.230	11.654.353	.020	.300	
	—	—	—	—	—	10.654.183	.012	.175	11.654.240	.014	.280	11.654.340	.014	.350	500-750
	10.654.996	.022	.600	.012	1.120	—	—	—	11.654.250	.018	.280	11.654.350	.020	.380	
	—	—	—	—	—	10.654.128	.014	.200	11.654.240	.016	.380	11.654.340	.016	.480	450-750
	11.654.994	.024	.750	.014	1.400	—	—	—	11.654.252	.020	.380	11.654.352	.022	.580	
	—	—	—	—	—	—	—	—	—	—	—	10.688.619	.018	.500	1000-2000
	—	—	—	—	—	10.654.128	.012	.175	11.654.240	.014	.330	11.654.340	.014	.420	300-425
	11.654.994	.022	.675	.012	1.250	—	—	—	11.654.252	.018	.330	11.654.352	.020	.480	
	—	—	—	—	—	—	—	—	11.654.249	.010	.160	11.654.344	.010	.200	100-225
	10.654.997	.016	.380	.008	.700	—	—	—	11.654.259	.012	.180	11.654.359	.014	.250	
	—	—	—	—	—	10.654.128	.014	.200	11.654.249	.016	.380	11.654.344	.016	.480	750-1000
	10.654.997	.024	.750	.014	1.400	—	—	—	11.654.259	.020	.380	11.654.359	.022	.580	
	—	—	—	—	—	10.654.187	.014	.250	10.654.277	.016	.500	—	—	—	1100-1600
	10.654.998	.030	.900	.015	1.625	—	—	—	10.654.287	.020	.500	10.654.387	.022	.650	

ROUGH BORING GUIDELINES

Insert Selection & Stock Allowance

KAISER indexable inserts outlined in the Insert Selection & Cutting Data tables have been selected to give optimum results. Grades and geometry do not have to be specified at time of order.

Insert radius is based upon 2 major factors:

1. Length/Diameter ratio of tool
2. Depth of cut or material allowance
 - Select the largest nose radius available for cutting edge strength & higher feeds
 - Use small nose radius for light depth of cut & extreme L/D ratio

Insert Radius	Minimum D.O.C.	Maximum D.O.C.	L/D Ratio
.008 (0)	.010	.060	>6:1
.016 (1)	.020	.120	≤5:1
.031 (2)	.040	.200	≤4:1
.047 (3)	.060	.325	≤4:1

• D.O.C. is stock allowance/side (radius)

Feed

1. Feed: Based on effective number of inserts, depending on roughing method
 - Balanced Cutting: 2 effective inserts
 - Stepped Cutting: 1 effective insert
 - Full Profile Cutting: 1 effective insert
2. Under normal rough boring operations, the effective feed rate is about 50% of nose radius

Nose Radius	Feed/IPR	
	Balanced Cutting	Stepped Cutting
.008 (0)	.008-.012	.004-.006
.016 (1)	.014-.016	.006-.008
.031 (2)	.020-.026	.012-.016
.047 (3)	.020-.030	.012-.020

Power Consumption

The power curve of the machine should be consulted and cutting data values adjusted accordingly.

- HP Requirements = MRR x K
- $MRR = d \times SFM \times IPR \times 12$
- MRR = metal removal rate, inches³
- d = radial depth of cut, inches
- SFM = surface feet/minute
- IPR = inches/rev

Material	K Factor*
Steel	.750
Alloy Steel	1.000
Cast Iron	.650
Aluminum	.430
High Temp Alloys	2.000

*With positive cutting geometry only

General Rule: Boring bar should always be smaller than original hole size.

CAUTION

It is very important to allow for clearance between boring bar and rough bore diameter.

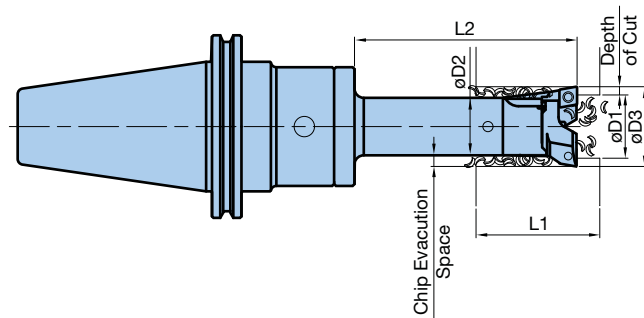

Under certain conditions, it may be necessary to modify or adapt recommended cutting data and/or tooling configurations of the application. Below are general solutions to common problems.

Problem	Possible Cause	Remedy
Poor Chip Control	Feed rate too low	Increase feed rate
	Excessive height variation of inserts	Preset tool to max. .0002" variation of both inserts
	Width of chip excessive (D.O.C.)	Preset tool for stepped cutting method
	Excessive stock allowance	Consult cutting data tables
Chatter & Vibration	Excessive speed	Reduce SFM, check cutting data tables
	Extreme length/diameter ratio	Shorten tool to increase stiffness
		Increase boring bar diameter to larger size
		Change boring bar to carbide or heavy metal
	Insert radius too large	Reduce nose radius of insert
	Unstable workpiece	Improve fixture and clamping support
Lead angle on insert holders	Change to 90 degree insert holders (type CC)	
Inserts Chipping or Breaking	Wrong insert	Change to tougher grade of carbide insert Use larger radius if available
	Severe interruption	Increase speed, decrease feed
	Chips packing and re-cutting	Check for boring bar/bore diameter clearance
		Improve chip control, increase feed
Poor Tool Life	Wrong insert	Change to higher wear resistant grade
	Excessive cutting speed	Reduce speed
	Inserts chipping	Check stock allowance and feed rate
	Coolant pressure too low	Increase through tool coolant pressure
		Adjust coolant ports of head if available
Chips Not Evacuating	Boring bar diameter too large	Reduce to smaller head and extended range holder
	Excessive stock allowance	Re-set tool for stepped cutting
	Inadequate space below bore	Elevate workpiece from table more
	Poor chip control	See above problem
Insufficient Machine Power	Excessive feed rate	Reduce feed; minimum 25% of insert radius
	Stock allowance excessive	Reset tool for stepped cutting method
	Low machine torque	RPM in area of low spindle torque; increase speed
		RPM in area of gear change; adjust RPM
		Change insert to higher rake angle
Reduce depth of cut		
Excessive Exit Burr	Excessive feed rate	Reduce feed rate
	CC type insert holders	Use square insert holders with 6 degree lead
	Cutting forces too high	Reduce depth of cut
		Reduce insert radius







KA6 Digital
EWD 2-54Pg. 54
Boring Range: ϕ .079"-2.126" (ϕ 2mm-54mm)
**NEW center insert holder extends range to ϕ 3.150"*

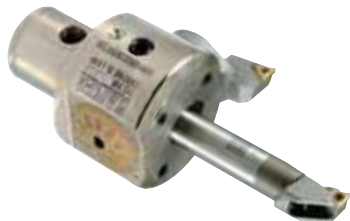

KA6 & Integral Shank
EWN 2-50XL.....Pg. 55-60
Boring Range: ϕ .079"-2.126" (ϕ 2mm-54mm) &
 ϕ 3.150"-6.000" (ϕ 80mm-152mm)
**NEW center insert holder extends range to ϕ 3.150"*



KA6
EWB 2-50Pg. 55-57
Boring Range: ϕ .079"-1.969" (ϕ 2mm-50mm)



KA4/ER25
EWN 04-22Pg. 62-63
Boring Range: ϕ .016"-.866" (ϕ .4mm-22mm)

KA5/ER32
EWN/EWB 2-32Pg. 64-66
Boring Range: ϕ .079"-1.260" (ϕ 2mm-32mm)

KA3
EWN 04-15Pg. 67
Boring Range: ϕ .016"-.590" (ϕ .4mm-15mm)

KA1
EWN 04-7Pg. 67
Boring Range: ϕ .016"-.276" (ϕ .4mm-7mm)

Spare Parts & Accessories.....Pg. 68-69

Insert Selection & Cutting Data.....Pg. 70-72

Guidelines.....Pg. 73



SERIES 112 EWD 2-54 DIGITAL HIGH PRECISION FINISH BORING HEAD

EWD 2-54 x KA6 or HSK-A63

NEW!

The EWD 2-54 precision boring head features absolute setting accuracy which is shown on a built-in digital display. The boring head with KA6 connection or integral HSK-A63 features an electronic measurement system on the tool carrier which provides ultra precise diameter adjustments for the newly extended boring range of $\varnothing.079$ "- 3.150 ". With one single button for the functions "on" and "reset", operating errors are practically eliminated.

Features:

- Setting accuracy $1\mu\text{m}/\varnothing$ or $.00005"/\varnothing$
- Diameter corrections are shown on a large and high contrast LCD display with a resolution of $.001\text{mm}/\varnothing$ or $.00005"/\varnothing$
- The measuring system for the tool carrier shows the effective movement and permits diameter corrections in both directions
- Automatic switch-off function which automatically stores the last displayed value
- Same accessories as for the precision boring head EWN 2-50XL
- Variable length adjustment of the tool holder ensures optimized tool lengths in the diameter range from $\varnothing.079$ "- 3.150 "
- Coated tool body for a complete protection against corrosion — IP 69K seal rating (highest possible)
- Fine balancing with a screw-fit balancing ring
- Radial adjustment range: $-.020"/+.100$ "
- Through-tool coolant supply up to 580 PSI



**MAX
20,000
RPM**

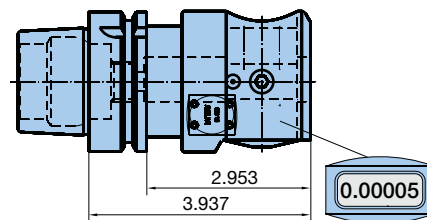
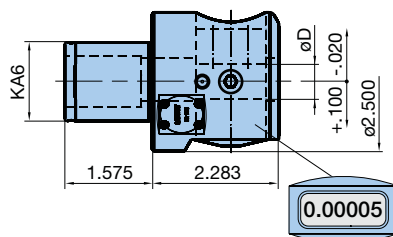

Adapter Size	Catalog Number	øD
KA6	10.112.119B	5/8"
KA6	10.112.109B	16mm
HSK-A63	10.112.125	16mm

Spare Parts

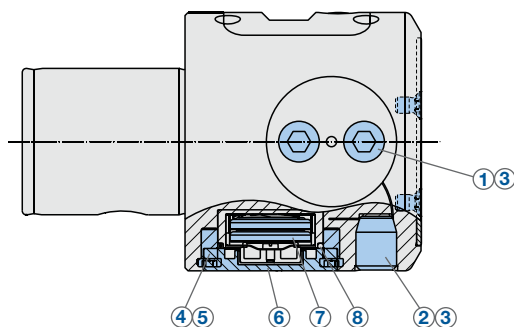

- ① 10.690.457
7 T (ft-lbs.)
- ② 10.690.469
7 T (ft-lbs.)
- ③ 10.690.816
- ④ 10.690.320
3 T (ft-lbs.)
- ⑤ 10.690.843
- ⑥ 10.195.090
Safety screw
- ⑦ 10.718.201
CR 2032
- ⑧ 10.692.296

The KAISER EWN 2-50XL boring heads offer the unique combination of precision and versatility. The boring heads are available with the modular KA6 connection to adapt to almost any spindle configuration, or as an integral version to offer the highest rigidity for the most common spindle tapers. A variety of accessories are available for the expanded standard range of ϕ .079"-3.150", and outward-mounted insert holders add an extended range of ϕ 3.150"-6.000". Additional accessories offer options for balanced assemblies, back boring, O.D. turning, and chamfering while boring.



Technical Data:

- Boring Range: ϕ .079"-3.150" (ϕ 2mm-80mm)
- Extended Range: ϕ 3.150"-6.000" (ϕ 80mm-152mm)
- Tool Holder Size (ϕ D): ϕ 5/8" or ϕ 16mm
- Dial Precision: 1 Div = ϕ .0002" (ϕ .005mm)
Vernier Precision: ϕ .00005" (ϕ .001mm)
- Maximum Through-Tool Coolant Pressure: 300 PSI

Adapter Type	Dial Units	Catalog Number	ϕ D
KA6	Inch	10.112.118	5/8"
	Metric	10.112.108	16mm
CAT40	Inch	10.112.134	5/8"
BT40	Inch	10.112.132	5/8"
	Metric	10.112.122	16mm
HSK-A63	Inch	10.112.133	5/8"
	Metric	10.112.123	16mm
BIG CAPTO C6	Inch	10.470.118	5/8"
	Metric	10.470.108	16mm

SPARE PARTS
PG. 68 

The KAISER EWB 2-50 boring heads maximize performance on small diameter bores due to an integrated counterweight which allows for precision balancing of the tool assembly. Balance charts are supplied with the head to give the correct setting of the graduated scale ring to fine balance the assembly for all of the various combinations possible with this versatile system.



U.S. PATENT
5,902,078

Technical Data:

- Boring Range: ϕ .079"-1.969" (ϕ 2mm-50mm)
- Tool Holder Size (ϕ D): ϕ 5/8" or ϕ 16mm
- Maximum Unbalance: 100g-mm
- Dial Precision: 1 Div = ϕ .0002" (ϕ .005mm)
- Vernier Precision: ϕ .00005" (ϕ .001mm)
- Maximum Through-Tool Coolant Pressure: 300 PSI

Adapter Type	Dial Units	Catalog Number	ϕ D
KA6	Inch	10.112.117	5/8"
	Metric	10.112.107	16mm

SPARE PARTS
PG. 68 

SERIES 112 EWD & EWN/EWB 2-50 HIGH PRECISION FINISH BORING HEADS

EWD 2-54 x KA6

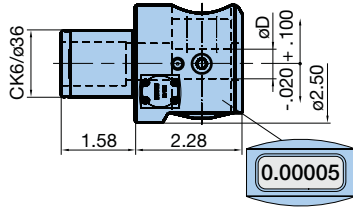

EWD 2-54 x HSK-A63

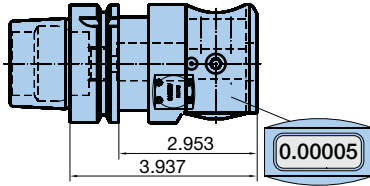

EWN 2-50XL x KA6

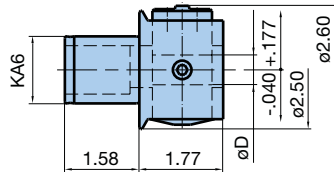

EWN 2-50XL x CAT/BT40

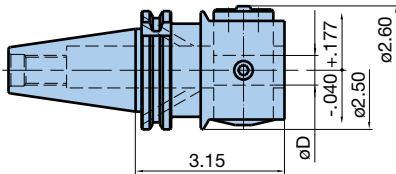

EWN 2-50XL x HSK-A63/C6

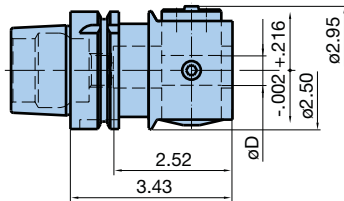

EWB 2-50 x KA6

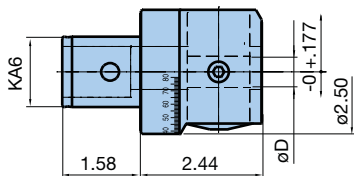

Reduction Bushings Type (Fig.)	Catalog Number	øD-ød	Reduction Sleeves	
			Catalog Number	øD-ød
1	10.613.524* 10.613.424*	5/8"-4mm 16-4mm	10.613.504 10.613.404	5/8"-4mm 16-4mm
1	10.613.522* 10.613.422*	5/8"-3.5mm 16-3.5mm	—	—
1	10.613.523* 10.613.423*	5/8"-4.5mm 16-4.5mm	—	—
1	10.613.525* 10.613.425*	5/8"-5mm 16-5mm	10.613.505 10.613.405	5/8"-5mm 16-5mm
1	10.613.526* 10.613.426*	5/8"-6mm 16-6mm	10.613.506 10.613.406	5/8"-6mm 16-6mm
2	10.613.527* 10.613.427*	5/8"-7mm 16-7mm	10.613.407	16-7mm
2	10.613.528* 10.613.428*	5/8"-8mm 16-8mm	10.613.508 10.613.408	5/8"-8mm 16-8mm
2	10.613.529* 10.613.429*	5/8"-9mm 16-9mm	10.613.509 10.613.409	5/8"-9mm 16-9mm
2	10.613.530* 10.613.430*	5/8"-10mm 16-10mm	10.613.510 10.613.410	5/8"-10mm 16-10mm

*Accessories for balanceable (EWB) boring heads

Reduction Bushings

Fig. 1

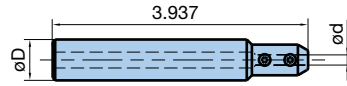
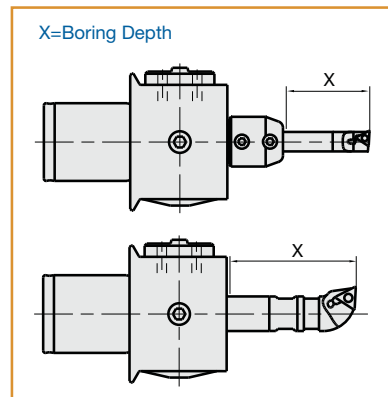
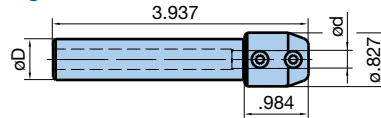
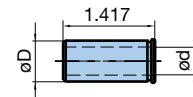

Fig. 2









10.613.511* 10.613.411*	5/8"-11mm 16-11mm
10.613.511* 10.613.411*	5/8"-11mm 16-11mm
10.613.512* 10.613.412*	5/8"-12mm 16-12mm
10.613.513* 10.613.413*	5/8"-13mm 16-13mm
10.613.513* 10.613.413*	5/8"-13mm 16-13mm
10.613.514* 10.613.414*	5/8"-14mm 16mm-14mm

Reduction Sleeves



INCH REDUCTION SLEEVES
PG. 60

Tool Holder Type	Catalog Number	ød	L	X Max	Insert Holders	Boring Range	Inserts		
1	10.611.155*	4mm	1.181	.354	Solid Carbide Boring Cutters	.079-.138	Solid Carbide Boring Cutters		
	10.611.156*		1.378	.551		.118-.177			
1	10.615.203*	3.5mm	2.441	1.575		.154-.236			
1	10.615.204*	4.5mm	2.913	1.969		.193-.275			
2	10.615.201*	5mm	3.346	2.362		—		.228-.287	WC..02
2	10.615.202*	6mm	3.740	2.756		—		.287-.346	
2	10.615.207*	7mm	3.150	1.969	—	—	.307-.464	TP..07	
	10.615.205*		4.528	3.346					
3 (M5)	10.615.211	8mm	1.850	1.378		10.615.271* (E9)	.346-.492		
	10.615.212*		2.835	2.362					
2	10.615.213*	9mm	4.133	2.953	—	—	.386-.531		
2	10.615.208*		3.937	2.756	—	—			
	10.615.206*		5.315	4.134					
3 (M6)	10.615.214	10mm	2.047	1.772		10.615.272* (E12)	.465-.571		
	10.615.215*		3.031	2.756					
	10.615.223*		3.819	3.543					
3 (M6)	10.615.250	11mm	5.000	4.724	—	—			
2	10.615.209*	11mm	5.315	4.134	—	—	.543-.650		
3 (M6)	10.615.218	12mm	3.031	2.756		10.615.273* (E14)			
	10.615.225		3.819	3.543					
	10.615.219*		4.213	3.937					
3 (M6)	10.615.224*	5.394	5.118	87°	—				
3 (M6)	10.615.251*	13mm	5.787	5.315	—	—	.582-.689 .622-.728		
2	10.615.210*	13mm	5.512	4.134	—	—			
3 (M6)	10.615.232	14mm	3.425	2.953		10.615.208* (E15) 10.615.281* (E16)			
	10.615.233*		4.606	4.134					
	10.615.221*		5.787	5.315					
3 (M10)	10.615.236	5/8"	3.465	3.150		10.615.282* (E18) 10.615.289* (E20) 10.615.283* (E22) 10.615.290* (E24) 10.615.288* (E25) 10.615.291* (E26) 10.615.284* (E28) 10.615.285* (E32) 10.615.286* (E36) 10.615.287* (E40) 10.615.292* (E45)	.700-.807 .780-.886 .858-.965 .937-1.004 .976-1.083 1.016-1.122 1.094-1.280 1.252-1.437 1.409-1.594 1.567-1.772 1.764-2.126		
	10.615.237*		4.252	3.937					
	10.615.238*		6.614	6.299					
	10.615.226	16mm	3.465	3.150					
	10.615.227*		4.252	3.937					
	10.615.229*		6.614	6.299					

Tool Holders

Fig. 1

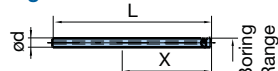

Fig. 3

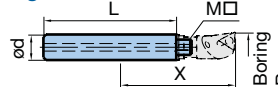
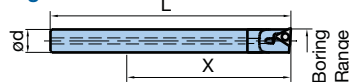

Fig. 2



*Accessories for balanceable (EWB) boring heads

 Carbide Tool Holders

OPTIONAL 90° INSERT HOLDERS  PG. 60

SPARE PARTS  PG. 68

SERIES 112 EWN 2-50XL HIGH PRECISION FINISH BORING HEADS

EWD 2-54 x KA6

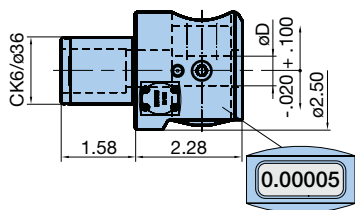

EWD 2-54 x HSK-A63

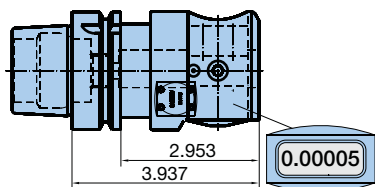

EWN 2-50XL x KA6

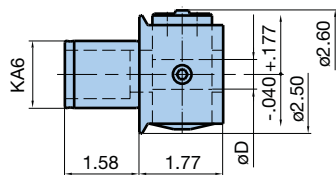

EWN 2-50XL x CAT/BT40

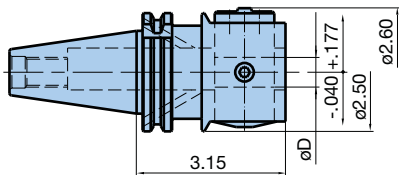

EWN 2-50XL x HSK-A63/C6

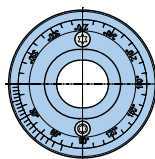
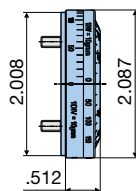
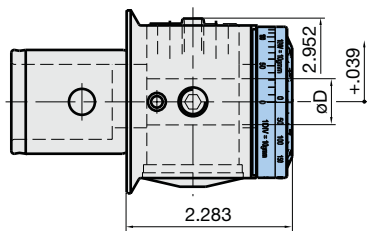
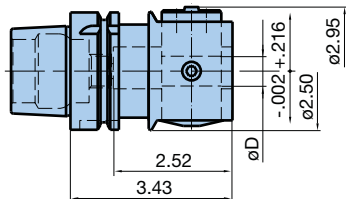

Balancing Ring



Catalog Number
10.112.806

Adjustable Tool Holders

Reduction Sleeves	Reduction Sleeves	
	Catalog Number	øD-ød
	10.613.509	5/8"-9mm
	10.613.409	16-9mm
	10.613.511	5/8"-11mm
	10.613.411	16-11mm
	10.613.513	5/8"-13mm
	10.613.413	16-13mm

These rings allow fine balancing of EWN 2-50XL boring heads for the entire range of ø.079"-2.126". Allowing compensation up to 200 gram-millimeters (g-mm), small diameter assemblies up to ø.394" can be balanced using standard bars and insert holders from Pg. 56. For larger diameters, unbalance can only be corrected when the tool holder is in the center position, therefore the use of radial adjustment insert holders is required.

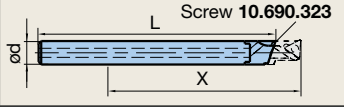
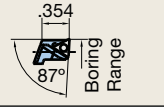
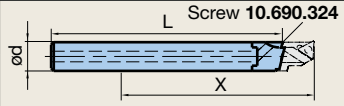
Correction of imbalance max. = 200g-mm, 1 Div = 10g-mm

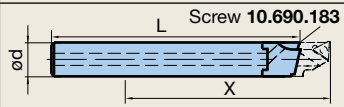
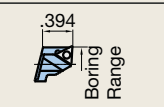
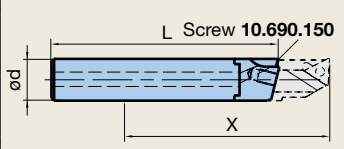
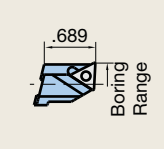
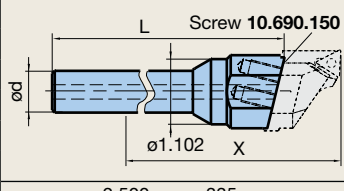
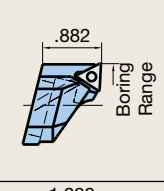
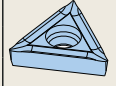
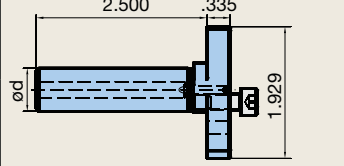
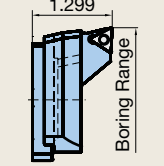
Adjustable Tool Holders	Catalog Number	ød	L	X Max	Insert Holders	Boring Range	Inserts
	10.615.374 10.615.369	9mm	3.583 4.764	2.756 3.937		10.615.365 .386-.472	
	10.615.376 10.615.371	11mm	4.331 5.512	3.543 4.724		10.615.366 .465-.551	TP..07 
	10.615.378 10.615.373	13mm	4.921 6.120	2.756 5.118		10.615.367 .543-.669	
	10.615.261	5/8"	3.858	3.15		10.615.301 10.615.302 10.615.303 .661-.866 .858-1.063 1.055-1.299	
	10.615.254	5/8"	4.645	3.937			
	10.615.255	5/8"	7.008	6.299			
	10.615.262	16mm	3.858	3.150			
	10.615.252	16mm	4.645	3.937			
	10.615.263	5/8"	4.055	3.543		10.615.304 10.615.305 1.252-1.575 1.567-2.126	TC..11 
	10.615.259	5/8"	5.197	4.331			
	10.615.260	5/8"	6.811	6.299			
	10.615.264	16mm	4.055	3.543			
	10.615.257	16mm	5.197	4.331			
	10.615.389	5/8"	—	—		10.615.306 2.125-3.150	
	10.615.387B	16mm	—	—			

*XL accessories not compatible with EWD 2-54

CAT40

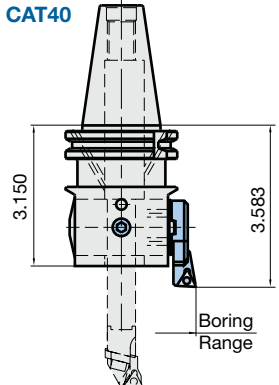



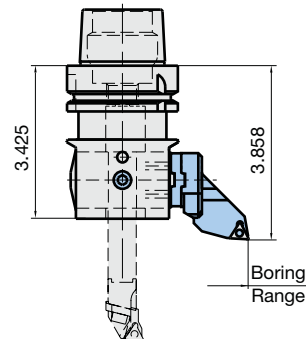

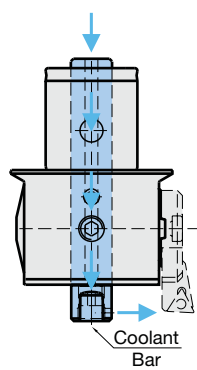
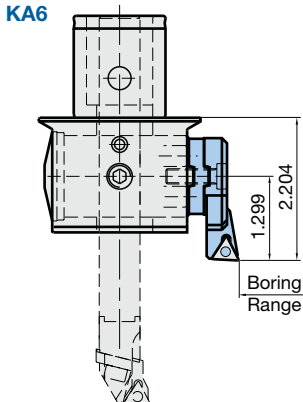

HSK-A63

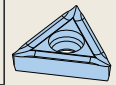

KA6

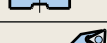

Accessories

	Catalog Number	Boring Range	Insert
	10.626.908	3.150-3.622	TC..11 
	10.626.908 10.626.907	3.622-4.094	
	10.626.909	4.094-4.567	
	10.626.909 10.626.907	4.567-5.039	
	10.626.910	5.039-5.512	
	10.626.910 10.626.907	5.512-6.000	
			
Coolant Bar (5/8")	10.615.236		
Coolant Bar (16mm)	10.615.226		
Coolant Nozzle	10.615.392		

SPARE PARTS
PG. 68-69 

SERIES 112 EWN 2-50XL HIGH PRECISION FINISH BORING HEADS

Back Boring

Tool Holders	Catalog Number	X Max	Insert Holders	Catalog Number	Min Entry Diameter	E	Boring Range	Insert
	10.615.214	1.575		11.689.801	.512	.113	.622-.728	TC..11
	10.615.215 10.615.223	2.559 3.346		11.689.802	.547	.151	.701-.807	
	10.615.218	2.559		11.689.803	.626	.152	.780-.898	
	10.615.219 10.615.224	3.740 4.921		11.689.804	.685	.212	.898-1.016	
	10.615.232	2.756		11.689.805	.783	.237	1.016-1.134	
	10.615.233 10.615.221	3.937 5.118						
	(5/8") 10.615.236	2.953 3.740 6.102		11.689.806	.882	.248	1.134-1.319	
	10.615.237			11.689.807	.941	.307	1.252-1.437	
	10.615.238 (16mm)			11.689.808	1.020	.385	1.409-1.594	
	10.615.226 10.615.227 10.615.229			11.689.809	1.098	.464	1.567-1.752	

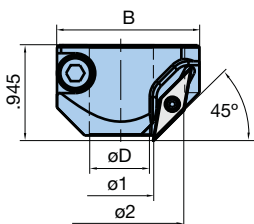

Chamfer Rings

D	Catalog Number	ø Min	ø Max	B
12mm	10.615.394	.496	1.091	1.378
5/8"	10.615.393	.654	1.248	1.555
16mm	10.615.395	.654	1.248	1.555

	Catalog Number	Type
Inserts	10.655.821 (ST)	VC..11 (.250" I.C.)
	10.655.822 (AL)	
Insert Screw	10.694.125	M2.5 x T8 IP

Bar Extensions & Reductions

Boring Range	Catalog Number	Boring Range	Catalog Number
.465-.571	10.615.230	.543-.728	10.615.231

Boring Range	Catalog Number	Boring Range	Catalog Number
.543-.650	10.615.220	.701-1.969	10.615.228

90° Insert Holders



Type	Catalog Number	Inserts
E12	11.689.810	CC..06 (1/4" I.C.)
E14	11.689.811	
E16	11.689.812	
E18	11.689.813	
E20	11.689.814	CC..09 (3/8" I.C.)
E22	11.689.815	
E24	11.689.816	
E25	11.689.817	
E26	11.689.818	
E28	11.689.819	
E30	11.689.820	
E32	11.689.821	
E36	11.689.822	
E40	11.689.823	
E45	11.689.824	

Inch Reduction Sleeves

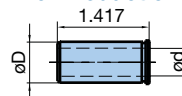

øD	ød	Catalog Number
.625	.125	11.613.543
.625	.156	11.613.544
.625	.187	11.613.545
.625	.250	11.613.546
.625	.312	11.613.548
.625	.375	11.613.550
.625	.438	11.613.551
.625	.500	11.613.552

Diameter Range: ϕ .350"-1.000"

KAISER's 112 series high precision boring head kit contains all components needed for small diameter bores from ϕ .350" to ϕ 1.000", including inserts and wrenches. The entire kit, including molded plastic carrying case with foam inlay to protect the precision instruments, provides considerable savings over what the boring head, reduction bushings, shanks and other components cost when ordered separately.



Contents

Reduction Bushing
10.613.508
10.613.510
10.613.512
10.613.514

Insert Holders
10.615.271
10.615.272
10.615.273
10.615.281
10.615.282
10.615.283

Adapter Size	Kit Number	Boring Head
KA6	11.112.911*	10.112.118
KA6	11.112.919*	10.112.119B**
BT40	11.112.914	10.112.132
CAT40	11.112.913	10.112.134
HSK-A63	11.112.912	10.112.133

Steel Boring Bars
10.615.211
10.615.214
10.615.218
10.615.232
10.615.236

Inserts (5 Pieces)
10.651.802
11.655.322

*Order shank separately for this kit
**Digital option

Diameter Range: ϕ .700"-6.000"

Enormous boring range with just one boring head! Thanks to a new insert holder as well as carefully selected accessories the latest "ready to go" tool kit of KAISER enables precise boring in the diameter range of ϕ .700"-6.000".

NEW!



Contents

Catalog Number
11.112.937

Boring Head
10.112.118 (KA6)

Steel Boring Bars
10.615.236
10.615.389

Center Insert Holders
10.615.282
10.615.288
10.615.285
10.615.287
10.615.292
10.615.306

Outboard Holders & Accessories
10.626.907
10.626.908
10.626.909
10.626.910
10.615.392

Inserts (10 pieces)
11.655.321

Case
10.671.150

SERIES 112 EWN 04-22 HIGH PRECISION FINISH BORING HEADS

The KAISER EWN 04-22 boring heads offer high precision machining of small diameter bores. These heads are designed for small-sized machines with spindle tapers such as BT30, HSK-40, and HSK-50. Additionally, screw-on type heads are available to adapt to turning centers with live tool turrets.

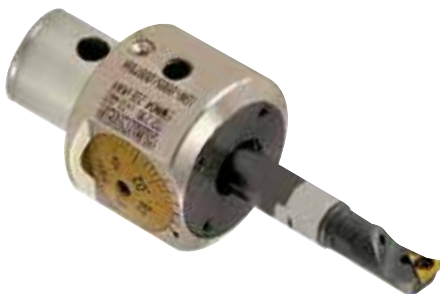

Technical Data:

- Boring Range: ϕ .079"-.866" (ϕ 2mm-22mm)
- Tool Holder Size (ϕ D): ϕ 10mm
- Dial Precision: 1 Div = ϕ .0005" (ϕ .01mm)
Vernier Precision: ϕ .0001" (ϕ .002mm)
- Maximum Through-Tool Coolant Pressure: 300 PSI

Reduction Sleeves	Catalog Numbers	ϕ D- ϕ d	
	10.613.204	10-4mm	
	10.613.202	10-3.5mm	
	10.613.203	10-4.5mm	
	10.613.205	10-5mm	
	10.613.206	10-6mm	
	10.613.207	10-7mm	
	10.613.208	10-8mm	

EWN 04-22E x KA4

Catalog Number: 10.112.216 Inch

EWN 04-22 x KA4

Catalog Number: 10.112.206 Metric

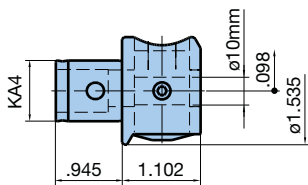

EWN 04-22E x ER25

Catalog Number: 10.112.215 Inch

EWN 04-22 x ER25

Catalog Number: 10.112.205 Metric

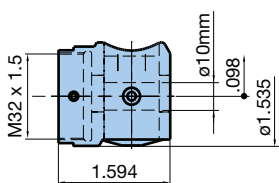

Optional 90° Insert Holders



Type	Catalog Number	Inserts
E12	11.689.810	CC..06 (1/4" I.C.)
E14	11.689.811	
E16	11.689.812	
E18	11.689.813	CC..09 (3/8" I.C.)
E20	11.689.814	



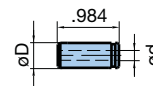





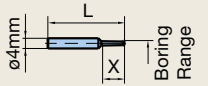
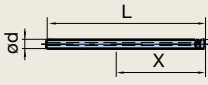
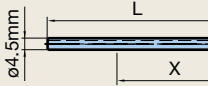
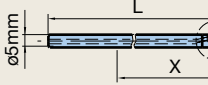
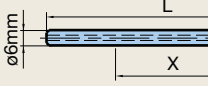

Optional Inch Reduction Sleeves

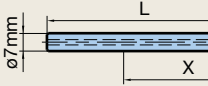
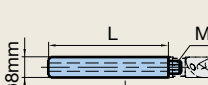

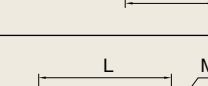
ϕ D	ϕ d	Catalog Number
10mm	.125	11.613.213
10mm	.156	11.613.214
10mm	.187	11.613.215
10mm	.250	11.613.216
10mm	.312	11.613.218

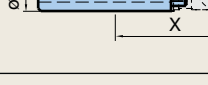
Screw-In Sleeve	Thread A1	Catalog Number
	ER25/ER20	10.112.271
	ER25/ER16	10.112.272

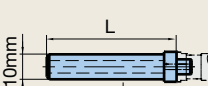
SERIES 112 EWN 04-22
HIGH PRECISION FINISH BORING HEADS

Tool Holders	Catalog Numbers	L	X	Insert Holders	Boring Range	Inserts		
	10.611.155	1.181	.354	Solid Carbide Boring Cutters	.079-.138	Solid Carbide Boring Cutters		
	10.611.156	1.378	.551		.118-.177			
	10.615.203	2.441	1.575		.154-.236			
	10.615.204	2.913	1.969		.193-.275			
	10.615.201	3.346	2.362		—		.228-.307	WC..02
	10.615.202	3.740	2.756		—		.287-.374	
	10.615.207	3.150	1.969	—	—	.307-.413		
	10.615.205	4.528	3.346					
	10.615.211	2.047	1.772		10.615.271 (E9)	.346-.492	TP.07	
	10.615.212	3.031	2.756					
	10.615.222	3.819	3.543					
	10.615.214	2.047	1.772		10.615.272 (E12)	.465-.571		
	10.615.215	3.031	2.756					
	10.615.223	3.819	3.543					
	10.615.216	2.047	1.772		10.615.273 (E14)	.543-.650	TC..11	
					10.615.280 (E15)	.583-.661		
					10.615.281 (E16)	.622-.728		
	10.615.217	2.047	1.929		10.615.282 (E18)	.701-.807		
					10.615.289 (E20)	.779-.886		

Carbide Tool Holders

SPARE PARTS
PG. 68



SERIES 112 EWD/EWN/EWB 2-32 HIGH PRECISION FINISH BORING HEADS

EWD 2-32E x KA5
Catalog Number:
10.112.319 Inch

EWD 2-32 x KA5
Catalog Number:
10.112.309 Metric

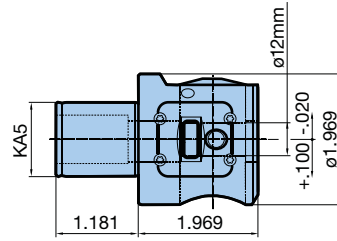

SPARE PARTS – EWD 2-32
Please contact **BIG Kaiser**
engineering department

Technical Data:

- Boring Range: $\phi.079$ "-1.260"
- Radial Adjustment Range: $-.020/+ .100$ "

EWB 2-32E x KA5
Catalog Number:
10.112.315 Inch

EWB 2-32 x KA5
Catalog Number:
10.112.306 Metric

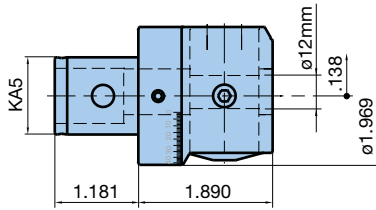
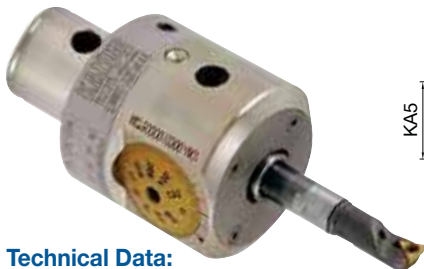

Technical Data:

- Boring Range: $\phi.079$ "-1.260" ($\phi 2\text{mm}$ -32mm)
- Dial Precision: 1 Div = $\phi.0002$ " ($\phi.01\text{mm}$)
Vernier Precision: $\phi.00005$ " ($\phi.002\text{mm}$)

EWN 2-32E x KA5
Catalog Number:
10.112.313 Inch

EWN 2-32 x KA5
Catalog Number:
10.112.301A Metric

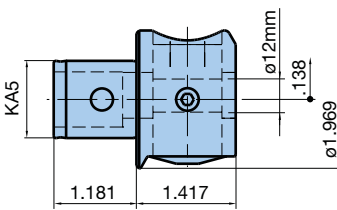
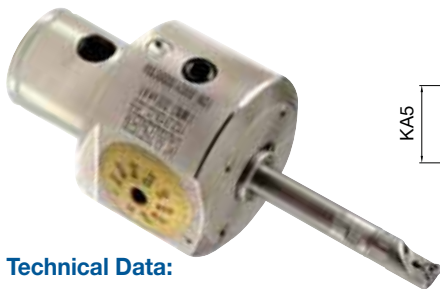

U.S. PATENT
5,902,078

Technical Data:

- Boring Range: $\phi.079$ "-1.260" ($\phi 2\text{mm}$ -32mm)
- Dial Precision: 1 Div = $\phi.0002$ " ($\phi.01\text{mm}$)
Vernier Precision: $\phi.00005$ " ($\phi.002\text{mm}$)

EWN 2-32E x ER32
Catalog Number:
10.112.317 Inch

EWN 2-32 x ER32
Catalog Number:
10.112.304A Metric

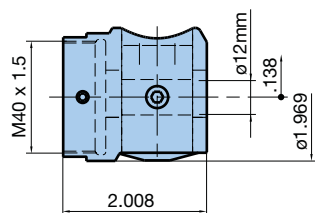

EWN2-32 Reducers		Type*	
Catalog Number	$\phi D-\phi d^*$		
10.613.324	12-4mm	1	
10.613.323	12-3.5mm	1	
10.613.326	12-4.5mm	1	
10.613.325	12-5mm	1	
10.613.327	12-6mm	2	
10.613.307	12-7mm	3	
10.613.308	12-8mm	3	
10.613.309	12-9mm	3	
10.613.310	12-10mm	3	

*See bottom of Pg. 65

Screw-In Sleeves	Thread A1	Catalog Number
	ER32/ER25	M32 x 1.5
	ER32/ER16	M22 x 1.5

SERIES 112 EWD/EWN/EWB 2-32 HIGH PRECISION FINISH BORING HEADS



Tool Holders	Catalog Number	L	X	Insert Holders	Boring Range	Inserts
	10.611.155	1.181	.354	Solid Carbide Boring Cutters	.079-.138	Solid Carbide Boring Cutters
	10.611.156	1.378	.551		.118-.177	
	10.615.203	2.441	1.575		.154-.236	
	10.615.204	2.913	1.969		.193-.275	
	10.615.201	3.346	2.362	—	—	WC..02
	10.615.202	3.740	2.756	—	—	
	10.615.207	3.150	1.969	—	—	TP..07
	10.615.205	4.528	3.346			
	10.615.211	2.047	1.772		10.615.271 (E9)	.346-.492
	10.615.212	3.031	2.756			
	10.615.222	3.819	3.543			
	10.615.208	3.937	2.756	—	—	.386-.531
	10.615.206	5.315	4.134			
	10.615.214	2.047	1.772		10.615.272 (E12)	.465-.571
	10.615.215	3.031	2.756			
	10.615.223	3.819	3.543			
	10.615.218	3.031	2.756		10.615.273 (E14)	.543-.650
	10.615.225	3.819	3.543			
	10.615.219	4.213	3.937			
	10.615.224	5.394	5.118			
	10.615.234	2.835	2.756		10.615.282 (E18) 10.615.289 (E20) 10.615.283 (E22) 10.615.290 (E24) 10.615.288 (E25) 10.615.291 (E26) 10.615.284 (E28)	.701-.807 .779-.886 .858-.965 .937-1.004 .976-1.083 1.016-1.122 1.094-1.280
	10.615.243	3.622	3.543			
	10.615.239	4.409	4.331			
	10.615.240	5.591	5.512			

Carbide Tool Holders

SPARE PARTS
PG. 68

EWN 2-32 Reducers

Type 1

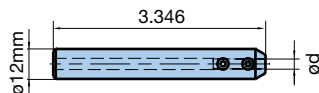

Type 2

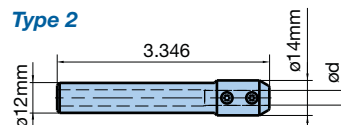

Type 3

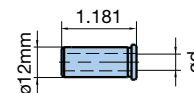

SERIES 112 EWD/EWN/EWB 2-32 HIGH PRECISION FINISH BORING HEADS

Adjustable Tool Holders

EWN 2-32 Reducers	Catalog Number	Adjustable Tool Holders	Catalog Number	L	X	Insert Holder	Boring Range	Inserts	
	10.613.309		10.615.369	4.764	3.937	10.615.365		.386-.472	TP..07
	10.613.310		10.615.370	4.724	3.937	10.615.366		.465-.551	
			10.615.372	5.512	4.724	10.615.367		.543-.669	
			10.615.256	4.764	3.937	10.615.301 10.615.302 10.615.303		.661-.866 .858-1.063 1.055-1.299	TC..11

Carbide Tool Holders

SPARE PARTS
PG. 68-69

Optional 90° Insert Holders



Type	Catalog Number	Inserts
E12	11.689.810	CC..06 (1/4" I.C.)
E14	11.689.811	
E16	11.689.812	
E18	11.689.813	CC..09 (3/8" I.C.)
E20	11.689.814	
E22	11.689.815	
E24	11.689.816	
E25	11.689.817	
E26	11.689.818	
E28	11.689.819	

Optional Reduction Sleeves

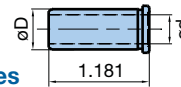

øD	ød	Catalog Number
12mm	4mm	11.613.304
12mm	5mm	11.613.305
12mm	.125	11.613.313
12mm	.156	11.613.314
12mm	.187	11.613.315
12mm	.250	11.613.316
12mm	.312	11.613.318



EWN 04-7 x KA1

Catalog Number: 10.112.513 Inch
10.112.503 Metric

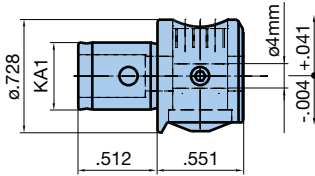

EWN 04-7 x ST6

Catalog Number: 10.112.518 Inch
10.112.508 Metric

EWN 04-7 x ST10

Catalog Number: 10.112.514 Inch
10.112.504 Metric

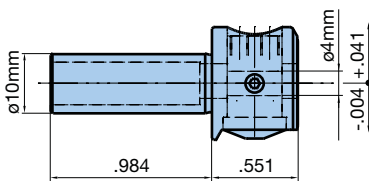

Technical Data:

- Boring Range: ϕ .016"-.275" (ϕ .4mm-7mm)
- Tool Holder Size: ϕ 4mm
- Dial Precision: 1 Div = ϕ .0005" (ϕ .01mm)
Vernier Precision: ϕ .0001" (ϕ .002mm)
- Maximum Through-Tool Coolant Pressure: 300 PSI

EWN 04-15 x ST16

Catalog Number: 10.112.516 Inch
10.112.506 Metric

EWN 04-15 x KA3

Catalog Number: 10.112.515 Inch
10.112.505 Metric

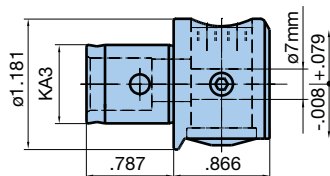

Technical Data:

- Boring Range: ϕ .016"-.590" (ϕ .4mm-15mm)
- Tool Holder Size: ϕ 7mm
- Dial Precision: 1 Div = ϕ .0005" (ϕ .01mm)
Vernier Precision: ϕ .0001" (ϕ .002mm)
- Maximum Through-Tool Coolant Pressure: 300 PSI

Solid Carbide Boring Cutters

Solid Carbide Boring Cutters	Catalog Number	L	X	Type	Boring Range
	10.615.541	1.181	.098	Coated ALCR10	.016-.035
	10.615.542		.157		.035-.055
	10.615.543		.236		.055-.078
	10.615.544		.275		.075-.118
	10.615.545		.394		.114-.157
	10.615.546		.512		.154-.197
	10.615.547		.630		.193-.275

EWN 04-7 – The World's Smallest Precision Boring Head



Indexable & Solid Carbide Boring Cutters

Boring Cutters	Catalog Number	L	X	Type	Boring Range
	10.615.522	2.047	.098	Coated ALCR10	.016-.039
	10.615.524		.157		.035-.059
	10.615.525		.236		.055-.079
	10.615.501		.275		.075-.118
	10.615.502		.394		.114-.157
	10.615.503		.512		.154-.197
	10.615.504		.630		.193-.236
	10.615.505	2.047	.787	WC..02	.228-.276
	10.615.506		.268-.315		
	10.615.507	1.181		TP..07	.307-.354
	10.615.508				.346-.394
	10.615.509				.386-.472
	10.615.511				.465-.590

Solid Carbide for Pin Turning	Catalog Number	L	X	Type	Boring Range
	10.615.530	2.047	.157	Coated ALCR10	0-.118
	10.615.531		.236		.079-.236

Carbide Tool Holders

SPARE PARTS
PG. 68

SERIES 112 SPARE PARTS

Service Instructions for 112 Heads

- Clean KA adapters prior to assembly
- Check cutting edge for wear prior to use
- All moving parts must be lubricated monthly using a light machine oil such as Mobil Vactra No. 2, BP Energol HLP-32, or Klueber Isoflex PDP94

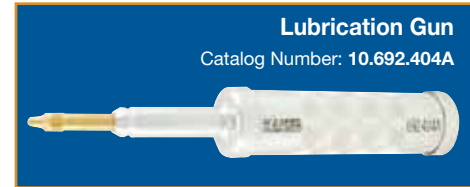
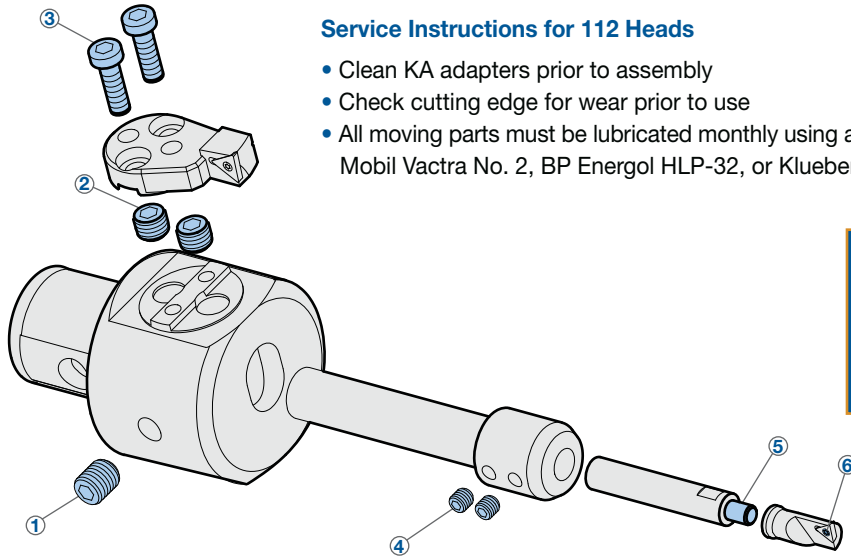

Boring Heads

Catalog Number	① Locking Screw	Torque (ft-lbs)	② Bar Locking Screw	Torque (ft-lbs)	③ Mounting Screw	Torque (ft-lbs)
EWN 2-50XL	10.690.452	7.5	10.690.595	7.5	10.690.156	9
EWB 2-50	10.690.452	7.5	10.690.595	7.5		
EWN/EWB 2-32	10.690.449	3.8	10.690.460	3.8		
EWN 04-22	10.690.489	1.8	10.690.421	1.8		
EWN 04-15	10.690.418	1.0	10.690.440	1.0		
EWN 04-7	10.690.978	.6	10.690.538	.6		

Reduction Bushings

ød	④ Reduction Set Screw	Torque (ft-lbs)
3.5mm	10.690.459	.4
4mm		
4.5mm		
5mm		
6mm	10.690.489	1.8
7mm		
8mm		
9mm		
10mm		

Bars, Extensions & Reductions

ød	Component	Thread	⑤ Boring Bar Screw
8mm	10.615.211	M5	10.690.486
	10.615.212		
	10.615.222		
10mm	10.615.214	M6	10.690.487
	10.615.215		
	10.615.223		
11mm	10.615.250	M6	10.690.487
12mm	10.615.218	M6	10.690.487
	10.615.219		
	10.615.224		
	10.615.225		
13mm	10.615.251	M6	10.690.487
14mm	10.615.232	M6	10.690.487
5/8"	10.615.236	M10	10.690.488
16mm	10.615.226	M10	10.690.488
10mm-12mm	10.615.216	M6	10.690.487
10mm-16mm	10.615.217	M6	10.690.487
12mm-16mm	10.615.239	M10	10.690.488
12mm-16mm	10.615.240	M10	10.690.488
12mm-16mm	10.615.243	M10	10.690.488
12mm	10.615.220	M6	10.690.487
16mm-10mm	10.615.230	M6	10.690.487
16mm-10mm	10.615.231	M6	10.690.487



Insert Screws

Insert Type	⑥ Insert Screw	Wrench
WC..02	10.694.101	10.694.806
TP..07	10.694.103*	10.694.806
TC..11	10.694.122	10.694.807
CC..06	10.694.122	10.694.807
CC..09	10.694.141	10.694.815

*For boring bars **10.615.205/207/507** use insert screw **10.694.102**

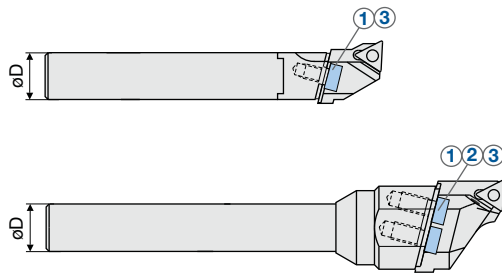
Adjustable Tool Holder Spare Parts



øD	Type			Torque (ft.-lbs.)	
		① Screw	② Washer		③ Wrench
9mm	10.615.369	10.690.323	—	.7	10.690.837
	10.615.374	10.690.323	—	.7	10.690.837
11mm	10.615.371	10.690.324	—	1.5	10.690.838
	10.615.375	10.690.324	—	1.5	10.690.838
	10.615.376	10.690.324	—	1.5	10.690.838
13mm	10.615.373	10.690.183	—	3.0	10.690.803
	10.615.377	10.690.183	—	3.0	10.690.803
	10.615.378	10.690.183	—	3.0	10.690.803
5/8"	10.615.254	10.690.113	—	7.4	10.690.804
	10.615.255	10.690.113	—	7.4	10.690.804
	10.615.261	10.690.113	—	7.4	10.690.804
16mm	10.615.252	10.690.113	—	7.4	10.690.804
	10.615.253	10.690.113	—	7.4	10.690.804
	10.615.262	10.690.113	—	7.4	10.690.804
	10.615.259	10.690.150	10.615.904	12.5	10.690.805
5/8"	10.615.260	10.690.150	10.615.904	12.5	10.690.805
	10.615.263	10.690.150	10.615.904	12.5	10.690.805
	10.615.257	10.690.150	10.615.904	12.5	10.690.805
16mm	10.615.258	10.690.150	10.615.904	12.5	10.690.805
	10.615.264	10.690.150	10.615.904	12.5	10.690.805

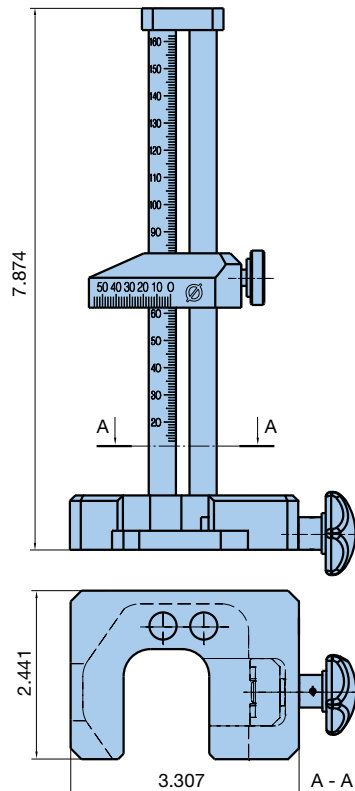

Setting Jig

The setting jig can be easily assembled on the front face of the boring heads EWN/EWB 2-50.

Set the measuring slide to the required projection length. Pull the tool holder until the cutting edge touches the lower end of the measuring slide. Align the cutting edge with the edge of the measuring slide.

The scale on the measuring slide provides a coarse diameter setting.

Catalog Number	Description
10.112.817	Setting Jig EWN2-50
10.112.819	Setting Jig EWN2-50 Inch

SERIES 112 SMALL DIAMETER FINISH BORING INSERT SELECTION & CUTTING DATA



Optimal Conditions:

- Length to diameter ratio less than 4:1
- Rigid fixture and workpiece
- Good machine spindle

Critical Conditions:

- Length to diameter ratio over 4:1
- Unstable fixture and/or workpiece
- Worn machine spindle/poor runout

Boring Range ϕ .228"-.650"

Material	Insert Radius	Stock Allow "/Dia.	Inserts & Cutting Speeds						Feed (IPR)
			Optimal Conditions			Critical Conditions			
			WC..02	TP..07	Speed (SFM)	WC..02	TP..07	Speed (SFM)	
Mild, Low-Carbon Steels 10xx-15xx 1018,1020, 1551, A36	.004	.004-.008	10.655.604	10.651.824	500-800	10.655.604	10.651.824	300-450	.0015-.0020
	.008	.008-.012	10.655.600	10.651.802		10.655.601	10.651.835		.0020-.0030
	.016	.012-.016	11.655.606	10.651.702		—	10.651.736		.0025-.0030
High Carbon Alloy Steels 23xx-92xx, Tool Steel 4140, 4340, 8620	.004	.004-.008	10.655.604	10.651.824	400-650	10.655.604	10.651.824	250-400	.0015-.0020
	.008	.008-.012	10.655.600	10.651.802		10.655.601	10.651.835		.0020-.0030
	.016	.012-.016	11.655.606	10.651.702		—	10.651.736		.0025-.0030
300 Stainless Steels Austenitic 303, 304, 316, 17-4ph	.004	.004-.008	10.655.606	—	250-500	10.655.606	—	200-300	.0010-.0015
	.008	.008-.012	10.655.602	10.651.837		10.655.602	10.651.837		.0015-.0020
	.012	.012-.016	—	10.651.737		—	10.651.737		.0020-.0250
400 Stainless Steels Martensitic 403, 410, 416, 430	.004	.004-.008	10.655.604	10.651.824	500-750	10.655.606	—	250-400	.0015-.0020
	.008	.008-.012	10.655.600	10.651.802		10.655.602	10.651.837		.0020-.0030
	.016	.012-.016	11.655.606	10.651.702		—	10.651.737		.0025-.0030
Grey Cast Iron Malleable Class 20, 30	.004	.004-.008	10.655.605	10.651.824	500-750	10.655.605	10.651.824	300-450	.0015-.0020
	.008	.008-.012	10.655.603	—		10.655.603	10.651.833		.0020-.0030
	.012	.012-.016	—	10.651.735		—	10.651.735		.0025-.0030
CBN-CH, CBN-CHN	—	.008-.012	11.938.863	11.938.872	750-1000	—	—	—	.0020-.0030
Cast Iron Ductile/Nodular/Chilled	.004	.004-.008	10.655.605	10.651.824	375-650	10.655.605	10.651.824	250-400	.0015-.0020
	.008	.008-.012	11.655.607	—		10.655.603	—		.0020-.0030
	.012	.012-.016	—	10.651.632		—	10.651.632		.0025-.0030
High Temp. Alloys Titanium, Inconel, Monel	.004	.003-.006	10.655.606	—	200-325	10.655.606	—	150-225	.0010-.0015
	.008	.006-.010	10.655.602	10.651.837		10.655.602	10.651.837		.0010-.0020
	.012	.008-.012	—	10.651.737		—	10.651.737		.0015-.0025
Copper Alloys Brass, Bronze	.004	.004-.008	—	—	600-1000	—	—	350-500	.0015
	.008	.008-.012	11.655.607	—		10.655.605	—		.0020
	.012	.012-.016	—	10.651.623		—	10.651.623		.0030
Aluminum/Magnesium 6061, 7075 Carbide Inserts	.004	.004-.008	10.655.605	10.651.823	600-1000	10.655.605	10.651.823	350-600	.0015-.0025
	.008	.008-.012	10.655.603	10.651.825		10.655.603	10.651.825		.0020-.0030
	.012	.012-.016	—	10.651.723		—	10.651.723		.0030-.0040
	.016	.016-.020	—	10.651.725		—	10.651.725		.0035-.0045
Aluminum/Magnesium 6061, 7075 PCD Inserts	.008	.010-.014	11.938.845	—	800-1350	—	—	—	.0020-.0030
	.012	.016-.020	—	10.938.840		—	—		.0030-.0040
Tool Steel (Min 50 Rc) CBN Inserts	.008	.004-.008	11.938.846	—	150-225	—	—	—	.0008-.0012
	.012	.004-.008	—	10.938.837		—	—		.0010-.0015

All cutting data without guarantee

Cutting Speed:

$$\text{RPM} = \frac{\text{SFM} \times 3.82}{\text{Bore } \phi}$$

Feed Rate:

$$\text{IPM} = \text{RPM} \times \text{IPR}$$

SERIES 112 SMALL DIAMETER FINISH BORING INSERT SELECTION & CUTTING DATA



Optimal Conditions:

- Length to diameter ratio less than 4:1
- Rigid fixture and workpiece
- Good machine spindle

Critical Conditions:

- Length to diameter ratio over 4:1
- Unstable fixture and/or workpiece
- Worn machine spindle/poor runout

Boring Range ϕ .583"-2.125"

Material	Insert Radius	Stock Allow "/Dia.	Inserts & Cutting Speeds								Feed (IPR)
			Optimal Conditions				Critical Conditions				
			TC..11	CC..06	CC..09	Speed (SFM)	TC..11	CC..06	CC..09	Speed (SFM)	
Mild, Low-Carbon Steels 10xx-15xx 1018,1020, 1551, A36	.008	.008-.012	11.656.352	11.654.856	—	1000-1450	10.655.372	11.654.840	—	525-675	.0015-.0025
	.016	.016-.020	11.655.322	11.654.865	11.654.959		10.655.381	11.654.850	11.654.940		.0030-.0040
	.031	.024-.040	11.655.332	11.654.867	11.654.960		—	—	—		.0050-.0060
High Carbon Alloy Steels 23xx-92xx, Tool Steel 4140, 4340, 8620	.008	.008-.012	11.656.352	11.654.856	—	800-1100	10.655.372	11.654.840	—	400-550	.0015-.0025
	.016	.016-.020	11.655.322	11.654.865	11.654.959		10.655.381	11.654.850	11.654.940		.0030-.0040
	.031	.024-.040	11.655.332	11.654.867	11.654.960		—	—	—		.0050-.0060
300 Stainless Steels Austenitic 303, 304, 316, 17-4ph	.008	.008-.012	10.655.379	11.654.856	—	550-800	10.655.379	—	—	350-525	.0015-.0025
	.016	.016-.020	10.655.389	11.654.865	11.654.959		10.655.389	11.654.845	11.654.968		.0030-.0040
	.031	.024-.040	10.655.399	11.654.867	11.654.960		—	—	—		.0050-.0060
400 Stainless Steels Martensitic 403, 410, 416, 430	.008	.008-.012	11.656.352	11.654.856	—	650-875	10.655.379	—	—	425-550	.0015-.0025
	.016	.016-.020	11.655.322	11.654.865	11.654.959		10.655.389	11.654.845	11.654.968		.0030-.0040
	.031	.024-.040	11.655.332	11.654.867	11.654.960		—	—	—		.0050-.0060
Grey Cast Iron Malleable Class 20, 30	.008	.008-.012	10.655.373	11.654.840	—	650-1000	10.655.373	—	—	350-500	.0015-.0025
	.016	.016-.020	10.655.383	11.654.850	11.654.940		10.655.383	11.654.868	11.654.968		.0030-.0040
	.031	.024-.050	10.655.393	11.654.860	11.654.952		—	—	—		.0050-.0060
CBN-CH, CBN-CHN	—	.016-.030	11.938.833	11.938.835	11.938.838	1500-2000	—	—	—	—	.0020-.0030
Silicon Nitride Si3N4	—	.016-.030	—	11.654.841	11.654.951	1000-1200	—	—	—	—	.0030-.0040
Cast Iron Ductile/Nodular/Chilled	.008	.008-.012	10.655.301	11.654.840	—	375-625	10.655.373	—	—	250-350	.0015-.0025
	.016	.016-.020	10.655.302	11.654.850	11.654.940		10.655.383	11.654.868	11.654.968		.0030-.0040
	.031	.024-.040	10.655.303	11.654.860	11.654.952		—	—	—		.0050-.0060
High Temp. Alloys Titanium, Inconel, Monel	.008	.008-.012	10.655.379	—	—	200-325	10.655.379	—	—	125-250	.0010-.0020
	.016	.016-.020	10.655.389	11.654.868	11.654.968		10.655.389	11.654.963	11.654.957		.0020-.0030
	.031	.024-.040	10.655.399	—	11.654.969		—	—	—		.0030-.0040
Copper Alloys Brass, Bronze	.008	.008-.012	11.655.315	—	—	1100-1800	11.655.315	—	—	400-700	.0015-.0025
	.016	.016-.020	11.655.325	11.654.858	11.654.957		11.655.325	11.654.858	11.654.957		.0030-.0040
	.031	.024-.040	11.655.335	11.654.864	11.654.958		—	—	—		.0050-.0060
Aluminum/Magnesium 6061, 7075 Carbide Inserts	.008	.008-.012	10.655.378	10.654.877	—	1200-1600	10.655.378	10.654.877	—	600-1100	.0015-.0025
	.016	.016-.020	10.655.388	10.654.888	10.654.977		10.655.388	10.654.888	11.654.977		.0030-.0040
	.031	.024-.040	10.655.398	10.654.898	10.654.987		—	—	—		.0050-.0060
Aluminum/Magnesium 6061, 7075 PCD Inserts	.008	.016-.020	11.938.861	11.938.847	—	2000-4000	—	—	—	—	.0015-.0025
	.016	.016-.020	10.938.841	11.938.842	11.938.843		—	—	—		.0030-.0040
	.031	.024-.050	11.938.860	—	11.938.851		—	—	—		.0050-.0060
Tool Steel (Min 50 Rc) CBN Inserts	.016	.016-.020	10.938.834	11.938.835	11.938.838	200-300	—	—	—	—	.0015-.0020
	.031	.024-.040	10.938.865	—	—	—	—	—	—	—	.0020-.0025

All cutting data without guarantee

Cutting Speed:

$$\text{RPM} = \frac{\text{SFM} \times 3.82}{\text{Bore } \phi}$$

Feed Rate:

$$\text{IPM} = \text{RPM} \times \text{IPR}$$

SERIES 112 EWN 2-50XL

EXTENDED RANGE INSERT SELECTION & CUTTING DATA



Boring Range ø3.150"-6.000"

Material	Insert Radius	Inserts & Cutting Speeds			
		Inserts	Stock Allow "/Dia.	Speed (SFM)	Feed (IPR)
Mild, Low-Carbon Steels 10xx-15xx 1018,1020, 1551, A36	.008	11.656.352	.008-.012	450-800	.0020
	.016	11.655.322	.016-.020		.0040
	.031	11.655.332	.024-.040		.0060
High Carbon Alloy Steels 23xx-92xx, Tool Steel 4140, 4340, 8620	.008	11.656.352	.008-.012	400-700	.0020
	.016	11.655.322	.016-.020		.0040
	.031	11.655.332	.024-.040		.0060
300 Stainless Steels Austenitic 303, 304, 316, 17-4ph	.008	10.655.379	.008-.012	350-550	.0020
	.016	10.655.389	.016-.020		.0040
	.031	10.655.399	.024-.040		.0060
400 Stainless Steels Martensitic 403, 410, 416, 430	.008	11.656.352	.008-.012	400-650	.0020
	.016	11.655.322	.016-.020		.0040
	.031	11.655.332	.024-.040		.0060
Grey Cast Iron Malleable Class 20, 30	.008	10.655.373	.008-.012	450-750	.0020
	.016	10.655.383	.016-.020		.0040
	.031	10.655.393	.024-.050		.0060
Cast Iron Ductile/Nodular/Chilled	.008	10.655.301	.008-.012	300-550	.0020
	.016	10.655.302	.016-.020		.0040
	.031	10.655.303	.024-.040		.0060
High Temp. Alloys Titanium, Inconel, Monel	.008	10.655.379	.008-.012	150-300	.0015
	.016	10.655.389	.016-.020		.0020
	.031	10.655.399	.024-.040		.0030
Copper Alloys Brass, Bronze	.008	11.655.315	.008-.012	550-800	.0020
	.016	11.655.325	.016-.020		.0040
	.031	11.655.335	.024-.040		.0060
Aluminum/Magnesium 6061, 7075 Carbide Inserts	.008	10.655.378	.008-.012	650-1000	.0020
	.016	10.655.388	.016-.020		.0040
	.031	10.655.398	.024-.040		.0060
Tool Steel (Min 50 Rc) CBN Inserts	.016	10.938.834	.016-.020	200-300	.0015
	.031	10.938.865	.024-.040		.0020

All cutting data without guarantee

Cutting Speed:

$$\text{RPM} = \frac{\text{SFM} \times 3.82}{\text{Bore } \phi}$$

Feed Rate:

$$\text{IPM} = \text{RPM} \times \text{IPR}$$

Major Influences of Finish Boring

- The amount of stock to be removed (D.O.C.)
- Feed rate
- Cutting speed

For all of these influences, a balance must be obtained for optimal machining. Too much stock or too heavy of a feed rate will generate excessive cutting forces that can result in inconsistent bore size. When stock or feed rates are too light, the possibility of chatter increases due to deflection.

D.O.C

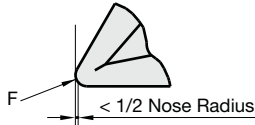

High Possibility for Deflection & Chatter:

When D.O.C. is less than half the insert nose radius, the resulting forces (F) are almost 100% radial.

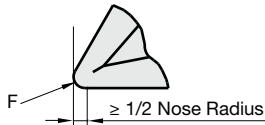

Good Stable Cut:

When D.O.C. is greater than or equal to half the insert nose radius, the resulting forces (F) are almost 100% axial.

FEED RATE

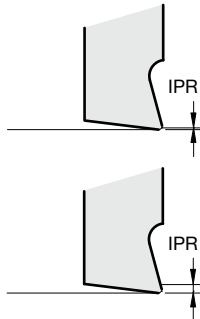

High Possibility for Deflection & Chatter:

When the feed rate is less than the hone on the insert tip, the risk of vibration increases.

Good Stable Cut:

When the feed rate is larger than the hone on the insert tip, full use of the chip breaker is allowed. This results in lower cutting forces.

CUTTING SPEED

Higher Speeds:

- Better surface finish
- Shorter machining times
- Better chip evacuation

As a general rule, the tool's length/diameter ratio and insert radius will determine optimum cutting speed.

*For smaller diameter bores, carbide or heavy metal bars may be required to eliminate vibration & chatter

Lower Speeds:

- Poorer surface finish
- Low chance for chatter
- Longer machining times
- High chance for built-up edge, results in shorter insert life

L/D Ratio	Max Insert Radius	Speed Reduction
≤4:1	.031	100% of optimum
≤5:1	.016	75% of optimum
≤6:1	.008	60% of optimum
≥7:1	.008	50% of optimum







Series 309

EWB-UP BalanceablePg. 76
Boring Range: ϕ .984"-3.937" (ϕ 25mm-100mm)



Series 310

EWD/EWNPg. 77-81
Boring Range: ϕ .787"-8.000" (ϕ 20mm-203mm)



Series 310

EWB Automatic BalancePg. 82-83
Boring Range: ϕ 1.260"-4.134" (ϕ 32mm-105mm)



Series 310

EWB-AL Automatic BalancePg. 82-83
Boring Range: ϕ 3.937"-8.000" (ϕ 100mm-203mm)



Series 310

EW Thread ConnectionPg. 84
Boring Range: ϕ .590"-.866" (ϕ 15mm-22mm)

Troubleshooting.....Pg. 85

Insert Selection & Cutting Data.....Pg. 86-87



SERIES 309 EWB-UP ULTRA PRECISION FINISH BORING HEADS ϕ .984"-3.937"

Series 309 EWB-UP – Peak Performance and Precision Uniquely Combined

Diameter adjustments in the sub-micron range and balance qualities of G6.3 are requirements for tight tolerance bores with maximum RPM's.

HIGHEST
ACCURACY & SPEED

MAX
20,000
RPM

High quality coated tool body for complete protection from corrosion

Free from movement with combined clamping of the insert holder and tool carrier

Course adjustment with setting scale

Balance adjust dial for quick & precise balance adjustment

Fine adjust large dial disc for parallax-free reading of the adjustment and Vernier

Inch Graduated Heads, 1 Div = .00005"/ ϕ , ϕ .984"-3.937"

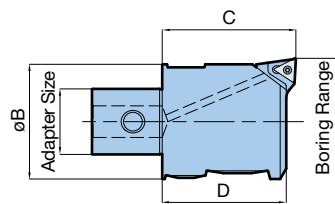

Head Type	Adapter Size	Catalog Number	Boring Range		ϕ B	C	D	Insert
			Min	Max				
EWB25UP	KA2	10.309.211	.984	1.299	0.921	1.398	1.358	TP.07
EWB32UP	KA3	10.309.311	1.260	1.654	1.181	1.575	1.457	TC..11
EWB41UP	KA4	10.309.411	1.614	2.126	1.496	1.850	1.693	TC..11
EWB53UP	KA5	10.309.511	2.087	2.756	1.929	2.244	2.087	TC..11
EWB68UP	KA6	10.309.611	2.677	3.937	2.520	2.795	2.646	TC..11

U.S. PATENT
7,585,139

Metric Graduated Heads, 1 Div = .001mm/ ϕ , ϕ 25mm-100mm

Head Type	Adapter Size	Catalog Number	Boring Range		ϕ B	C	D	Insert
			Min	Max				
EWB25UP	KA2	10.309.201	25	33	23.4	35.5	32.5	TP.07
EWB32UP	KA3	10.309.301	32	42	30	40	37	TC..11
EWB41UP	KA4	10.309.401	41	54	38	47	43	TC..11
EWB53UP	KA5	10.309.501	53	70	49	57	53	TC..11
EWB68UP	KA6	10.309.601	68	100	64	71	67.2	TC..11

• Insert holders are included with EWB-UP boring heads

Spare Parts

Type	① Insert Holder	② Mounting Screw	③ Washer	Torque (ft.-lbs.)	④ Locking Screw	Torque (ft.-lbs.)	⑤ Head Clamping	Torque (in.-lbs.)
EWB25UP	10.627.121	10.690.182	10.693.289	.8	—	.8	10.690.940	9
EWB32UP	10.627.131	10.690.179	10.693.186	1.1	10.690.550	1.1	10.690.180	13
EWB41UP	10.627.141	10.690.176	10.693.175	1.8	10.690.943	1.8	10.690.115	22
EWB53UP	10.627.151	10.690.177	10.693.176	2.9	10.690.658	2.9	10.690.178	35
EWB68UP	10.627.161	10.690.953	10.693.177	3.7	10.690.591	3.7	10.690.156	58

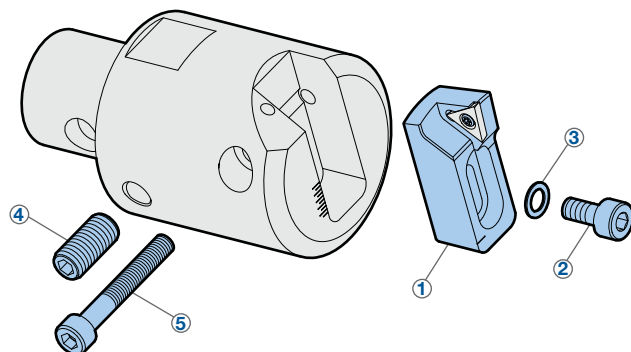

Highest Precision and Versatility

The KAISER Series 310 EWD precision boring head features absolute setting accuracy shown on a built-in digital display. The robust measurement system shows precise linear movement of the tool carrier permitting diameter adjustments of $\varnothing.00005''$ or $\varnothing.001\text{mm}$. These boring heads utilize existing insert holders from program 310 EWN to allow compatibility with existing designs.

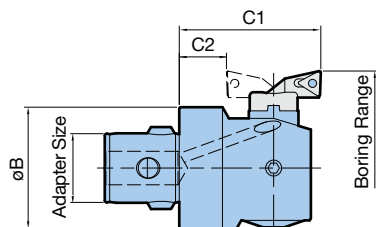
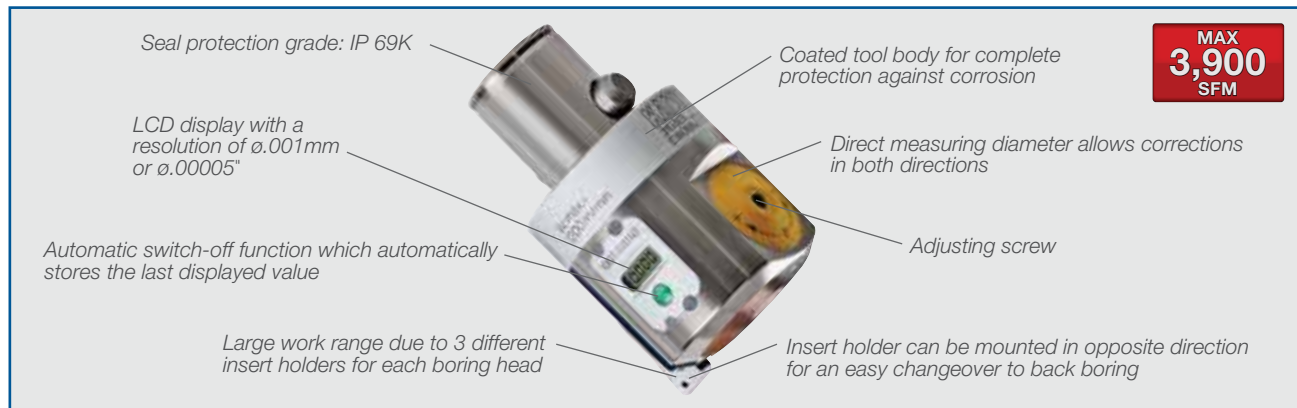

Inch Resolution, 1 Div = .00005"/ \varnothing , $\varnothing 1.614''-8.000''$

Head Type	Adapter Size	Catalog Number	Boring Range		Back Boring		$\varnothing B$	C1	C2
			Min	Max	Min	Max			
EWD41	KAB4	10.310.413	1.614	2.913	2.087	2.913	1.496	1.850	.551
EWD53	KAB5	10.310.513	2.087	3.740	2.441	3.740	1.929	2.244	.748
EWD68	KAB6	10.310.613	2.677	5.906	3.071	5.906	2.520	2.795	.866
EWD100	KAB6	10.310.614	3.937	8.000	4.331	8.000	3.543	2.795	.866
EWD100	KAB7	10.310.713	3.937	8.000	4.331	8.000	3.543	3.425	1.496

Metric Resolution, 1 Div = .001mm/ \varnothing , $\varnothing 41\text{mm}-203\text{mm}$

Head Type	Adapter Size	Catalog Number	Boring Range		Back Boring		$\varnothing B$	C1	C2
			Min	Max	Min	Max			
EWD41	KAB4	10.310.403	41	74	53	74	38	47	14
EWD53	KAB5	10.310.503	53	95	62	95	49	57	19
EWD68	KAB6	10.310.603	68	150	78	150	64	71	22
EWD100	KAB6	10.310.604	100	203	110	203	90	71	22
EWD100	KAB7	10.310.703	100	203	110	203	90	87	38

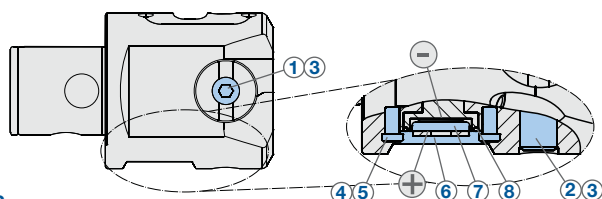

Spare Parts

Type	1 Screw	Torque (ft-lbs)	2 Screw	Torque (ft-lbs)	3 Wrench	4 Screw	Torque (ft-lbs)	5 Trox Wrench	6 Battery	7 Battery	8 O-Ring
EWD41	10.690.138	2.2	10.690.997	2.5	10.690.813	10.690.994	.7	10.694.808	10.310.905	10.696.901	10.692.381
EWD53	10.690.139	4.4	10.690.996	6.0	10.690.814						
EWD68	10.690.141	11.0	10.690.469	10.0	10.690.815						
EWD100			10.690.553								

SERIES 310 EWN HIGH PRECISION FINISH BORING HEADS ϕ .787"-8.000"

U.S. PATENT
5,857,811

Series 310 EWN Heads – High Precision Vernier Setting to .0001"!

Features:

- Largest work range of any system by using 3 insert holders for each head
- Balanced at midpoint of travel for high cutting speeds and improved bore quality
- Insert holder can be mounted in opposite direction for back bore applications
- Through spindle coolant capability is standard, with directional coolant ports, size EWN41 and larger

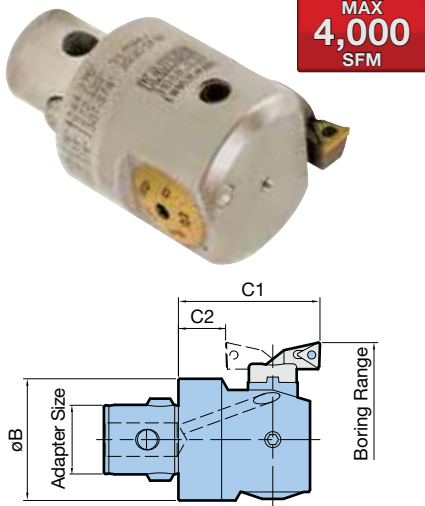

Inch Graduated Heads, 1 Div = .0005"/ ϕ (.0001"/ ϕ Vernier), ϕ .787"-8.000"

Head Type	Adapter Size	Catalog Number	Boring Range		Back Boring		ϕ B	C1	C2
			Min	Max	Min	Max			
EWN20	KAB1	10.310.111	.787	1.417	1.102	1.417	.728	1.280	.413
EWN25	KAB2	10.310.211	.984	1.850	1.417	1.850	.921	1.398	.453
EWN32	KAB3	10.310.311	1.260	2.362	1.811	2.362	1.181	1.575	.394
EWN41	KAB4	10.310.411	1.614	2.913	2.087	2.913	1.496	1.850	.551
EWN53	KAB5	10.310.511	2.087	3.740	2.441	3.740	1.929	2.244	.748
EWN68	KAB6	10.310.611	2.677	5.906	3.071	5.906	2.520	2.795	.866
EWN100	KAB6	10.310.612	3.937	8.000	4.331	8.000	3.543	2.795	.866
EWN100	KAB7	10.310.711	3.937	8.000	4.331	8.000	3.543	3.425	1.496
EWN100	KAB7	10.310.718	3.937	8.000	4.331	8.000	3.543	4.606	2.677

Metric Graduated Heads, 1 Div = .01mm/ ϕ (.002mm/ ϕ Vernier), ϕ 20mm-203mm

Head Type	Adapter Size	Catalog Number	Boring Range		Back Boring		ϕ B	C1	C2
			Min	Max	Min	Max			
EWN20	KAB1	10.310.101	20	36	28	36	18.5	32.5	10.5
EWN25	KAB2	10.310.201	25	47	36	47	23.4	35.5	11.5
EWN32	KAB3	10.310.301	32	60	46	60	30	40	10
EWN41	KAB4	10.310.401	41	74	53	74	38	47	14
EWN53	KAB5	10.310.501	53	95	62	95	49	57	19
EWN68	KAB6	10.310.601	68	150	78	150	64	71	22
EWN100	KAB6	10.310.602	100	203	110	203	90	71	22
EWN100	KAB7	10.310.701	100	203	110	203	90	87	38
EWN100	KAB7	10.310.708	100	203	110	203	90	117	68

Polygon Taper

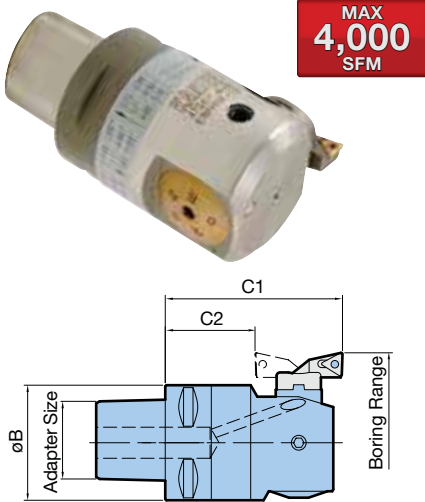

Inch Graduated Heads, 1 Div = .0005"/ ϕ (.0001"/ ϕ Vernier), ϕ 1.260"-8.000"

Head Type	Adapter Size	Catalog Number	Boring Range		Back Boring		ϕ B	C1	C2
			Min	Max	Min	Max			
EWN32	C3	10.470.311	1.260	2.362	1.811	2.362	1.260	2.165	.984
EWN41	C4	10.470.411	1.614	2.913	2.087	2.913	1.575	2.638	1.339
EWN53	C5	10.470.511	2.087	3.740	2.441	3.740	1.969	3.031	1.535
EWN68	C6	10.470.611	2.677	5.906	3.071	5.906	2.520	3.622	1.693
EWN100	C6	10.470.612	3.937	8.000	4.331	8.000	2.520	3.622	1.693

Metric Graduated Heads, 1 Div = .01mm/ ϕ (.002mm/ ϕ Vernier), ϕ 32mm-203mm

Head Type	Adapter Size	Catalog Number	Boring Range		Back Boring		ϕ B	C1	C2
			Min	Max	Min	Max			
EWN32	C3	10.470.301	32	60	46	60	32	55	25
EWN41	C4	10.470.401	41	74	53	74	40	67	34
EWN53	C5	10.470.501	53	95	62	95	50	77	39
EWN68	C6	10.470.601	68	150	78	150	64	92	43
EWN100	C6	10.470.602	100	203	110	203	64	92	43

INSERT HOLDERS
PG. 79-80 

SPARE PARTS
PG. 81 

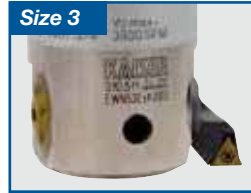
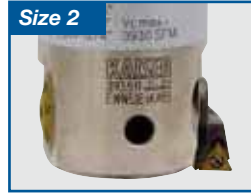

Triangular Insert Holders

Size 1

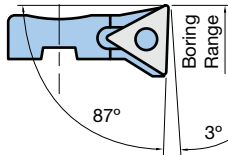

Size 2

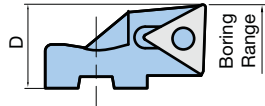

Size 3

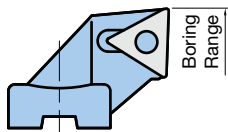

Head Type	Catalog Number	Insert Holder Size	Boring Range		Back Boring Range		D	Insert	Insert Screw
			Min	Max	Min	Max			
EWN20	10.626.111	11	.787	1.024	—	—	.183	TP..07	10.694.103
	10.626.112	12	.984	1.220	1.102	1.220	.281		
	10.626.113	13	1.181	1.417	1.181	1.417	.380		
EWN25	10.626.121	21	.984	1.299	—	—	.215	TP..07	10.694.103
	10.626.122	22	1.260	1.575	1.417	1.575	.352		
	10.626.123	23	1.535	1.850	1.535	1.850	.490		
EWN32	10.626.131	31	1.260	1.654	—	—	.291	TC..11	10.694.122
	10.626.132	32	1.614	2.008	1.811	2.008	.469		
	10.626.133	33	1.969	2.362	1.969	2.362	.646		
EWN41 EWD41	10.626.141	41	1.614	2.126	—	—	.319	TC..11	10.694.122
	10.626.142	42	1.969	2.480	2.087	2.480	.496		
	10.626.143	43	2.402	2.913	2.402	2.913	.713		
EWN53 EWD53	10.626.151	51	2.087	2.756	2.441	2.756	.394	TC..11	10.694.122
	10.626.152	52	2.559	3.228	2.717	3.228	.630		
	10.626.153	53	3.070	3.740	3.070	3.740	.886		
EWN68 EWD68	10.626.161	61	2.677	3.937	3.151	3.937	.492	TC..11	10.694.122
	10.626.162	62	3.700	4.960	3.700	4.960	1.004		
	10.626.163	63	4.646	5.906	4.646	5.906	1.476		
EWN100 EWD100	10.626.161	61	3.937	6.024	4.409	6.024	.492	TC..11	10.694.122
	10.626.162	62	4.960	7.047	4.960	7.047	1.004		
	10.626.163	63	5.906	8.000	5.906	8.000	1.476		

90° Square Shoulder Insert Holders

Size 1

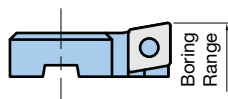

Size 2

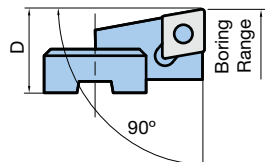

Size 3

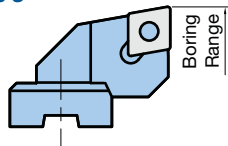

Head Type	Catalog Number	Insert Holder Size	Boring Range		Back Boring Range		D	Insert	Insert Screw
			Min	Max	Min	Max			
EWN25	10.626.322	22	1.299	1.614	1.417	1.614	.372	CC..06	10.694.122
	10.626.323	23	1.535	1.850	1.535	1.850	.490		
EWN32	11.626.331	31	1.260	1.654	—	—	.291	CC..06	10.694.122
	10.626.332	32	1.614	2.008	1.811	2.008	.469		
	10.626.333	33	1.969	2.362	1.969	2.362	.646		
EWN41 EWD41	11.626.341	41	1.614	2.126	—	—	.319	CC..06	10.694.122
	10.626.342	42	1.969	2.480	2.087	2.480	.496		
	10.626.343	43	2.402	2.913	2.402	2.913	.713		
EWN53 EWD53	11.626.351	51	2.087	2.756	2.441	2.756	.394	CC..09	10.694.141
	10.626.352	52	2.441	3.110	2.756	3.110	.571		
	10.626.353	53	3.070	3.740	3.070	3.740	.886		
EWN68 EWD68	11.626.361	61	2.677	3.937	3.151	3.937	.492	CC..09	10.694.141
	10.626.364	62	3.700	4.960	3.700	4.960	1.004		
	10.626.363	63	4.252	5.512	4.252	5.512	1.280		
EWN100 EWD100	11.626.361	61	3.937	6.024	4.409	6.024	.492	CC..09	10.694.141
	10.626.364	62	4.960	7.047	4.960	7.047	.689		
	10.626.363	63	5.512	7.600	5.512	7.600	1.280		

SERIES 310 EWD/EWN ACCESSORY INSERT HOLDERS

30° Triangular Insert Holders

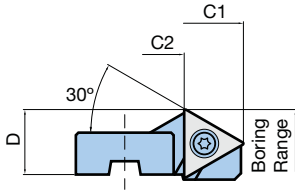

Head Type	Catalog Number	Insert Holder Size	Boring Range		Length		D	Insert	Insert Screw
			Min	Max	C1	C2			
EWN25	11.380.321	21	1.102	1.417	1.398	1.173	.274	TP..07	10.694.103
EWN32	11.380.322	31	1.417	1.811	1.654	1.311	.370	TC..11	10.694.122
EWN41 EWD41	11.380.323	41	1.772	2.283	1.929	1.587	.398	TC..11	10.694.122
EWN53 EWD53	11.380.324	51	2.205	2.874	2.244	1.906	.453	TC..11	10.694.122
EWN68 EWD68	11.380.325	61	2.677	3.937	2.795	2.453	.492	TC..11	10.694.122
EWN100 EWD100	11.380.325	61	3.937	6.024	3.425	3.083	.492	TC..11	10.694.122

45° Triangular Insert Holders

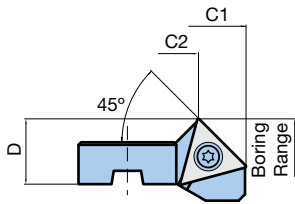

Head Type	Catalog Number	Insert Holder Size	Boring Range		Length		D	Insert	Insert Screw
			Min	Max	C1	C2			
EWN25	11.380.326	21	1.102	1.417	1.398	1.213	.274	TP..07	10.694.103
EWN32	11.380.327	31	1.417	1.811	1.654	1.370	.370	TC..11	10.694.122
EWN41 EWD41	11.380.328	41	1.772	2.283	1.929	1.646	.398	TC..11	10.694.122
EWN53 EWD53	11.380.329	51	2.205	2.874	2.244	1.961	.453	TC..11	10.694.122
EWN68 EWD68	11.380.330	61	2.677	3.937	2.795	2.512	.492	TC..11	10.694.122
EWN100 EWD100	11.380.330	61	3.937	6.024	3.425	3.142	.492	TC..11	10.694.122

115° Triangular Insert Holders

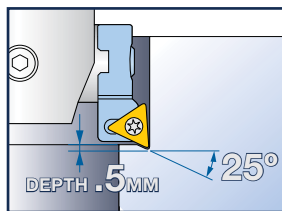
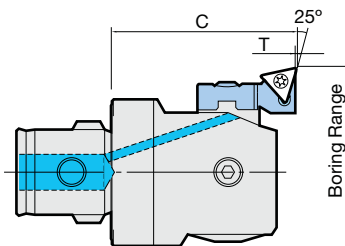

Insert holder to undercut corners

Head Type	Catalog Number	Insert Holder Size	Boring Range		C	T Max	Insert	Insert Screw
			Min	Max				
EWN41 EWD41	11.380.306	41	1.614	2.126	1.850	.024	TC..11	10.694.122
EWN53 EWD53	11.380.341	51	2.087	2.756	2.244	.024	TC..11	10.694.122
EWN68 EWD68	11.380.587	61	2.677	3.937	2.795	.024	TC..11	10.694.122
EWN100 EWD100	11.380.587	61	3.937	6.024	3.425	.024	TC..11	10.694.122

Back Boring

Adequate clearance between the boring tool and the entry bore must be assured to prevent tool or workpiece damage.

Example:

Minimum entry bore diameter "C" of 2.750"

Back bore diameter "A" of 3.250"

Solution:

Maximum body diameter of tool "B":

$$\begin{aligned} B \text{ max} &= (2 \times C) - A \\ &= (2 \times 2.750) - 3.250 \\ &= 2.250" \end{aligned}$$

The largest boring head with less than 2.250" body diameter is EWN53, 10.310.511 with KAB5 tool connection, body diameter of 1.929". Insert holder selection is determined by back bore diameter of 3.250". Size 3 insert holder must be specified.

For insert type TC..11, use catalog number **10.626.153**

For insert type CC..09, use catalog number **10.626.353**

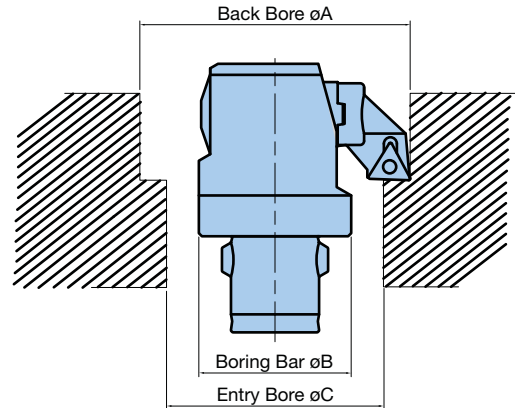

Back Bore & Entry Bore Diameters

Maximum Back Bore Diameter "A"	A Max = (2xC) - B
Maximum Body Diameter "B"	B Max = (2xC) - A
Minimum Entry Bore Diameter "C"	C Min = (A+B)/2

Service Instructions for 310 EWN Heads

- Clean KA adapters prior to assembly
- Check cutting edge for wear prior to use
- All moving parts must be lubricated monthly using a light machine oil such as Mobil Vactra No. 2, BP Energol HLP-32, or Klueber Isoflex PDP94

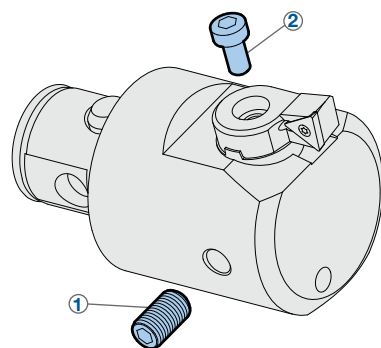
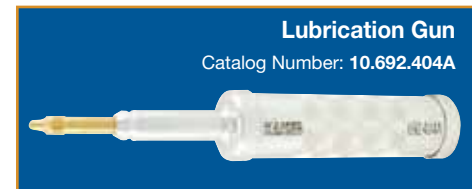

Spare Parts

Head Type	① Locking Screws		② Mounting Screws		Wrench
	Catalog Number	Torque (ft/lbs.)	Catalog Number	Torque (ft/lbs.)	
EWN20	10.690.410	.4	10.690.135	.8	10.690.811
EWN25	10.690.549	.4	10.690.136	.8	10.690.811
EWN32	10.690.550	1.2	10.690.137	1.6	10.690.812
EWN41	10.690.551	1.6	10.690.138	2.1	10.690.813
EWN53	10.690.552	4.2	10.690.139	4.1	10.690.814
EWN68	10.690.553	7.5	10.690.141	11	10.690.816
EWN100	10.690.553	7.5	10.690.141	11	10.690.816

SERIES 310 EWB AUTOBALANCE HIGH PRECISION FINISH BORING HEADS $\phi 1.260''$ - $8.000''$

High quality coated tool body for protection against corrosion

Only 5 different boring heads to cover the range from $\phi 1.260''$ - $4.134''$

Smooth, play-free micrometer spindle with inch or metric graduations

Through spindle coolant

Automatic precision balance over entire adjustment range

Combined clamping for both the micrometer cartridge and the balance counterweight

MAX 6,600 SFM

Ultra light weight aluminum construction

Only 2 different boring heads to cover the range from $\phi 3.937''$ - $8.000''$

Highly accurate cutting edge adjustment

Hard coated surface for improved wear and scratch resistance

Large adjustment range

Combined clamping for both the micrometer cartridge and the balance counterweight

MAX 6,600 SFM

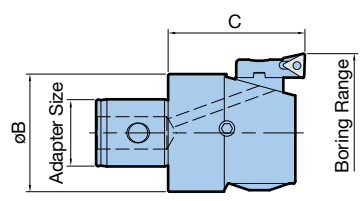

HIGH SPEED

U.S. PATENT
5,909,986
5,857,811

Inch Graduated Heads, 1 Div = .0005"/ ϕ (.0001"/ ϕ Vernier), $\phi 1.260''$ - $8.000''$

Head Type	Adapter Size	Catalog Number	Boring Range		ϕB	C	Inserts
			Min	Max			
EWB32	KA3	10.310.315A	1.260	1.654	1.181	1.575	TP..07
EWB41	KA4	10.310.415A	1.614	2.126	1.496	1.850	TC..11
EWB53	KA5	10.310.515A	2.087	2.756	1.929	2.244	TC..11
EWB68	KA6	10.310.615A	2.677	3.465	2.480	2.795	TC..11
EWB85	KA6	10.310.616A	3.346	4.134	2.480	2.795	TC..11
EWB100	KA6	10.310.617	3.937	6.024	3.543	2.795	TC..11
EWB150	KA6	10.310.618	5.906	8.000	4.960	2.795	TC..11
EWB100	KA7	10.310.715	3.937	6.024	3.543	3.425	TC..11
EWB150	KA7	10.310.716	5.906	8.000	4.960	3.425	TC..11

Metric Graduated Heads, 1 Div = .01mm/ ϕ (.002mm/ ϕ Vernier), $\phi 32$ mm- 203 mm

Head Type	Adapter Size	Catalog Number	Boring Range		ϕB	C	Inserts
			Min	Max			
EWB32	KA3	10.310.305A	32	42	30	40	TP..07
EWB41	KA4	10.310.405A	41	54	38	47	TC..11
EWB53	KA5	10.310.505A	53	70	49	57	TC..11
EWB68	KA6	10.310.605A	68	88	63	71	TC..11
EWB85	KA6	10.310.606A	85	105	63	71	TC..11
EWB100	KA6	10.310.607	100	153	90	71	TC..11
EWB150	KA6	10.310.608	150	203	126	71	TC..11
EWB100	KA7	10.310.705	100	153	90	87	TC..11
EWB150	KA7	10.310.706	150	203	126	87	TC..11

• Insert holders are included with 310 EWB heads

SPARE PARTS
PG. 83

Autobalance boring heads, Series 310 EWB, maintain perfect balance throughout the work range due to the integrated counter-balance mechanism. The counterweight can only compensate for one size insert holder, so the work range is similar to EWN heads with a Size 1 insert holder.

Series 310 EWN boring heads are pre-balanced at one position only; the mid-range of the tool carrier travel with a Size 1 insert holder. Adjustment of the bore diameter from this position and/or use of Size 2 and 3 insert holders will require reduction of cutting speed values due to increased unbalance forces.

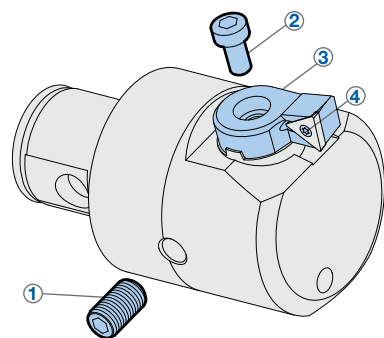
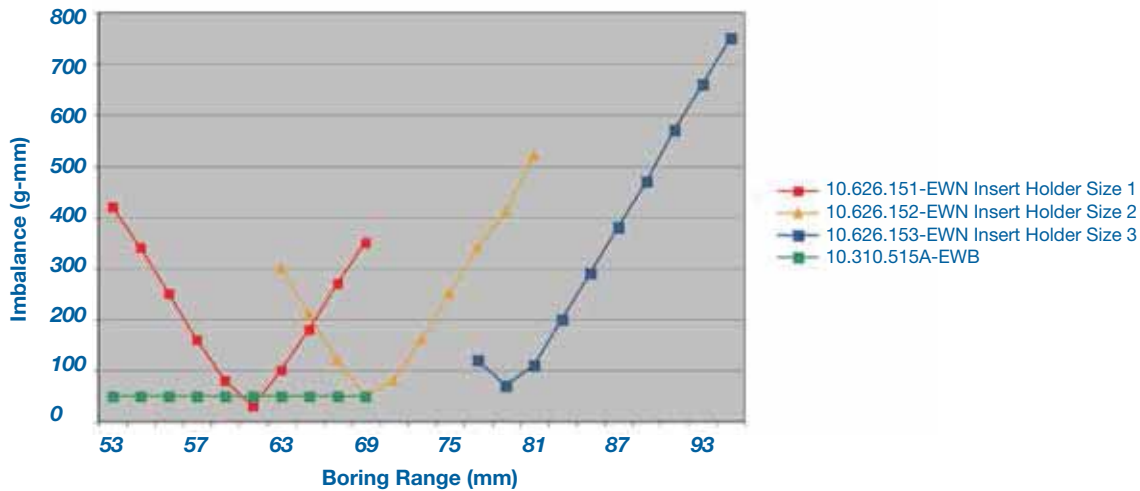
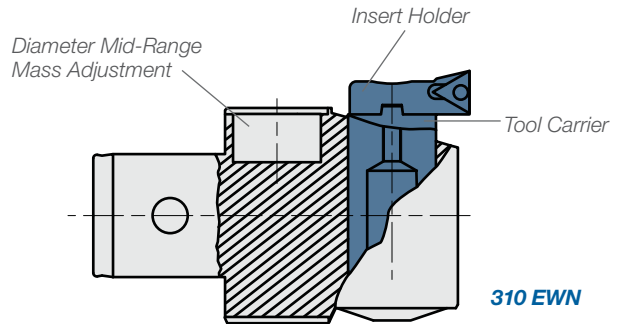
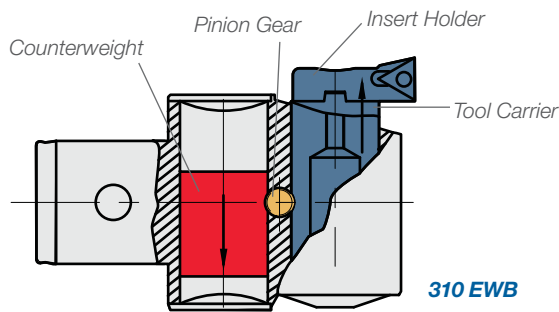

Spare Parts

Head Type	① Locking Screw		② Mounting Screw		Boring Head Wrench	③ Insert Holders	④ Insert Screws
	Catalog Number	Torque (in-lbs.)	Catalog Number	Torque (in-lbs.)			
EWB32	10.690.577	20	10.690.137	20	10.690.812	10.626.231	10.694.103
EWB41	10.690.578	25	10.690.138	25	10.690.813	10.626.241	10.694.122
EWB53	10.690.579	50	10.690.139	50	10.690.814	10.626.251	10.694.122
EWB68	10.690.580	105	10.690.140	105	10.690.816	10.626.261	10.694.122
EWB85	10.690.580	105	10.690.140	105	10.690.816	10.626.261	10.694.122
EWB100	10.690.580	105	10.690.140	105	10.690.816	10.626.261	10.694.122
EWB150	10.690.580	105	10.690.140	105	10.690.816	10.626.261	10.694.122

CAUTION ⚠

DO NOT substitute insert holders from program EWN.

SERIES 310 EW HIGH PRECISION FINISH BORING HEADS ϕ .590"-.866"

KAISER 310 EW series boring heads are designed for precision production boring on machining centers, boring mills, and jig borers. Their compact and well balanced design makes them suitable for small diameter bores in confined areas, as well as easily accessible bores.

Features:

- Smooth, play-free micrometer spindle with inch or metric graduations
- Easy to adapt to any machine via straight shank boring bar
- ISO standard insert pockets with replaceable insert holders
- No diameter change after locking tool
- Through-spindle coolant
- Minimal unbalance of tool

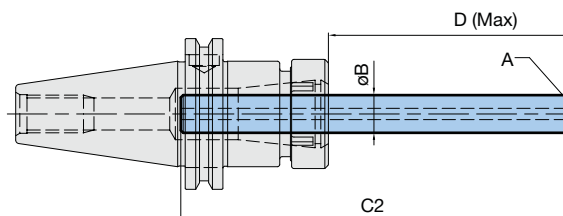

Inch Graduated Heads 1 Div = .0005"/ ϕ (.0001"/ ϕ Vernier)

Head Type	Thread A	Catalog Number	Boring Range		ϕ B	C1	Insert Holders
			Min	Max			
EW15	M6	10.310.021	.590	.728	.551	1.181	10.625.020
EW18	M10	10.310.031	.708	.866	.630	1.417	

Metric Graduated Heads 1 Div = .01mm/ ϕ (.002mm/ ϕ Vernier)

Head Type	Thread A	Catalog Number	Boring Range		ϕ B	C1	Insert Holders
			Min	Max			
EW15	M6	10.310.020	15	18.5	14	30	10.625.020
EW18	M10	10.310.030	18	22	16	36	

Boring Bars

Head Type	Thread A	ϕ B	Catalog Number	C2	Bore Depth D
EW15	M6	.551	10.615.232	3.425	3.230
			10.615.233	4.606	4.410
			10.615.221	5.787	5.590
EW18	M10	.625	10.615.236	3.464	3.500
			10.615.237	4.251	4.290
			10.615.238	6.614	6.650

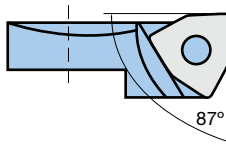

Insert Holders (Sold Separately)

Head Type	Catalog Number	Inserts	Insert Screws
EW15	10.625.020	WC..02	10.694.101
EW18			

Carbide Tool Holders

Spare Parts

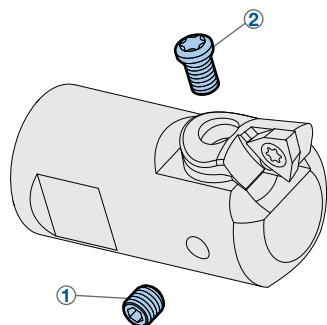

Head Type				
	① Locking Screw	② Mounting Screw	Torx Wrench	Hex Wrench
10.310.021/.020	10.690.414	10.694.120	10.690.835	10.690.800
10.310.031/.030	10.690.416			

Under certain conditions, it may be necessary to modify or adapt recommended cutting data and/or tooling configurations of the application. Below are general solutions to common problems.

Problem	Possible Cause	Remedy
Poor Tool Life	Wrong insert grade	Change to higher wear resistant grade
	Excessive speed	Reduce SFM
	Poor cooling of insert	Apply through-tool coolant
	Excessive stock allowance	Decrease depth of cut
Chatter & Vibration	Excessive speed	Reduce SFM, check cutting data tables
	Extreme length/diameter ratio	Shorten tool to increase stiffness
		Increase boring bar diameter to larger size
		Change boring bar to carbide or heavy metal
	Wrong insert	Reduce nose radius of insert
		Use ground geometry inserts (ie: TAN18 grade)
Incorrect stock allowance	Check cutting data tables	
Poor Size Repeatability	Inaccurate tool changes	Worn and/or damaged tool shank; replace
		Clean spindle and tool shank
	Variation of stock allowance	Semi-finish with twin insert boring head
	Excessive spindle looseness	Use ground geometry inserts (ie: TAN18 grade)
Unacceptable Roundness	Excessive boring tool imbalance	Change to auto-balance or balanceable head
		Balance tool assembly
		Reduce speed
	Excessive cutting forces	Check stock allowance and feed rate
	Insufficient workpiece clamping	Check for uniform workpiece clamping
	Workpiece non-symmetrical	Reduce cutting forces; change to ground insert
Increase cutting speed, reduce feed		
Unacceptable Position	Original bore off position	Semi-finish with twin insert boring head
	Excessive stock allowance	Decrease depth of cut
		Decrease insert radius
		Reduce cutting forces; change to ground insert
Poor Surface Finish	Wrong insert radius	Use larger insert radius
	Excessive feed rate	Reduce feed; maximum 25% of insert radius
	Poor chip evacuation	Increase bore to boring bar clearances
		Apply through-tool coolant; adjust nozzles
		Change insert to higher rake angle
		Check depth of cut
Taper	Premature insert wear	Change to higher wear resistance insert grade
		Increase insert radius
		Change from ground to pressed geometry insert
		Increase coolant flow



FINISH BORING INSERT SELECTION & CUTTING DATA

Recommended Under Optimal Conditions

- Length to diameter ratio less than 4:1
- Rigid fixture and workpiece
- Good machine spindle
- Setup not chatter prone
- Insert holder Size 1 (EWN)



Optimal Conditions

Material	Insert Radius	Insert Type & Size				Stock Allow. On Dia.	Feed (IPR)	Speed (SFM)
		TP..07	TC..11	CC..06	CC..09			
Mild, Low-Carbon Steel 10xx-15xx 1018,1020,1551, A36	.008	10.651.802	11.656.352	11.654.856	—	.008-.012	.0020	1000-1450
	.016	10.651.702	11.655.322	11.654.865	11.654.959	.016-.020	.0040	
	.031	—	11.655.332	11.654.867	11.654.960	.024-.040	.0060	
High Carbon Alloy Steel 23xx-92xx, Tool Steel 4140, 4340, 8620	.008	10.651.802	11.656.352	11.654.856	—	.008-.012	.0020	800-1100
	.016	10.651.702	11.655.322	11.654.865	11.654.959	.016-.020	.0040	
	.031	—	11.655.332	11.654.867	11.654.960	.024-.040	.0060	
300 Stainless Steel Austenitic 303, 304, 316, 17-4ph	.008	10.651.802	11.656.352	11.654.856	—	.008-.012	.0020	550-800
	.016	10.651.702	11.655.322	11.654.865	11.654.959	.016-.020	.0040	
	.031	—	11.655.332	11.654.867	11.654.960	.024-.040	.0060	
400 Stainless Steel Martensitic 403, 410, 416, 430	.008	10.651.802	11.656.352	11.654.856	—	.008-.012	.0020	650-875
	.016	10.651.702	11.655.322	11.654.865	11.654.959	.016-.020	.0040	
	.031	—	11.655.332	11.654.867	11.654.960	.024-.040	.0060	
Grey Cast Iron Malleable Class 20, 30	.008	—	10.655.373	11.654.840	—	.008-.012	.0020	650-1000
	.012	10.651.735	—	—	—	.010-.014	.0030	
	.016	—	10.655.383	11.654.850	11.654.940	.016-.020	.0040	
	.031	—	10.655.393	11.654.860	11.654.952	.024-.050	.0060	
CBN-CH, CBN-CHN	—	11.938.872	11.938.833	11.938.835	11.938.838	.008-.016	.0030	1500-2000
Silicon Nitride Si3N4	—	—	—	11.654.841	11.654.951	.016-.026	.0050	1000-1200
Cast Iron Ductile/Nodular/Chilled	.008	—	10.655.301	11.654.840	—	.008-.012	.0020	375-625
	.012	10.651.632	—	—	—	.010-.014	.0030	
	.016	—	10.655.302	11.654.850	11.654.940	.016-.020	.0040	
	.031	—	10.655.303	11.654.860	11.654.952	.024-.040	.0060	
High Temp. Alloys Titanium, Inconel, Monel	.008	10.651.837	10.655.379	—	—	.006-.010	.0015	200-325
	.012	10.651.737	—	—	—	.008-.012	.0020	
	.016	—	10.655.389	11.654.868	11.654.968	.012-.016	.0020	
	.031	—	10.655.399	11.654.869	11.654.969	.018-.032	.0030	
Copper Alloys Brass, Bronze	.008	—	11.655.315	—	—	.008-.012	.0020	1100-1800
	.012	10.651.623	—	—	—	.010-.014	.0030	
	.016	—	11.655.325	11.654.858	11.654.957	.016-.020	.0040	
	.031	—	11.655.335	11.654.864	11.654.958	.024-.050	.0060	
Aluminum/Magnesium 6061, 7075	.008	10.651.825	10.655.378	10.654.877	—	.008-.012	.0020	1200-1600
	.016	10.651.725	10.655.387	10.654.888	10.654.977	.016-.020	.0040	
	.031	11.651.923	10.655.397	10.654.898	10.654.987	.024-.040	.0060	
Aluminum/Magnesium 6061, 7075 PCD Inserts	.008	—	11.938.861	11.938.847	—	.008-.012	.0020	2000-4000
	.012	10.938.840	—	—	—	.010-.014	.0030	
	.016	—	10.938.841	11.938.842	11.938.843	.016-.020	.0040	
	.031	11.938.830	11.938.860	—	11.938.851	.024-.050	.0060	
Hardened Steel Min. 50HRc CBN Inserts	.008	—	—	—	—	.004-.008	.0010	200-300
	.012	10.938.837	—	—	—	.004-.008	.0010	
	.016	—	10.938.834	11.938.835	11.938.838	.005-.010	.0015	
	0.031	—	10.938.865	—	—	.006-.012	.0020	

All cutting data without guarantee

Cutting Speed:

$$\text{RPM} = \frac{\text{SFM} \times 3.82}{\text{Bore } \phi}$$

Feed Rate:

$$\text{IPM} = \text{RPM} \times \text{IPR}$$

Recommended Under Critical Conditions

- Length to diameter ratio over 5:1
- Unstable fixture and/or workpiece
- Excessive spindle looseness
- Setup chatter prone
- Insert holder Size 2 and 3 (EWN)



Critical Conditions

Materials	Insert Radius	Insert Type & Size				Stock Allow on Dia.	Feed (IPR)	Speed (SFM)
		TP..07	TC..11	CC..06	CC..09			
Mild, Low-Carbon Steel 10xx-15xx 1018,1020,1551, A36	.004	10.651.824	10.655.363	—	—	.003-.006	.0010	525-675
	.008	10.651.835	10.655.372	11.654.840	—	.006-.010	.0015	
	.012	10.651.736	—	—	—	.010-.014	.0020	
	.016	—	10.655.386	11.654.850	11.654.940	.014-.020	.0020	
High Carbon Alloy Steel 23xx-92xx, Tool Steel 4140, 4340, 8620	.004	10.651.824	10.655.363	—	—	.003-.006	.0010	400-550
	.008	10.651.835	10.655.372	11.654.840	—	.006-.010	.0015	
	.012	10.651.736	—	—	—	.010-.014	.0020	
	.016	10.651.734	10.655.386	11.654.850	11.654.940	.014-.020	.0020	
300 Stainless Steel Austenitic 303, 304, 316, 17-4ph	.004	10.651.824	10.655.363	—	—	.003-.006	.0010	350-525
	.008	10.651.837	10.655.379	—	—	.006-.010	.0015	
	.012	10.651.737	—	—	—	.010-.014	.0020	
	.016	10.651.734	10.655.389	11.654.845	11.654.968	.014-.020	.0020	
400 Stainless Steel Martensitic 403, 410, 416, 430	.004	10.651.824	10.655.363	—	—	.003-.006	.0010	425-550
	.008	10.651.837	10.655.379	—	—	.006-.010	.0015	
	.012	10.651.737	—	—	—	.010-.014	.0020	
	.016	10.651.734	10.655.389	11.654.845	11.654.968	.014-.020	.0020	
Grey Cast Iron Malleable Class 20, 30	.004	10.651.824	10.655.363	—	—	.003-.006	.0010	350-500
	.008	10.651.833	10.655.373	—	—	.006-.010	.0020	
	.012	10.651.735	—	—	—	.010-.014	.0020	
	.016	10.651.734	10.655.383	11.654.868	11.654.968	.014-.020	.0030	
Cast Iron Ductile/Nodular/Chilled	.004	10.651.824	10.655.363	—	—	.003-.006	.0010	250-350
	.008	—	10.655.373	—	—	.006-.010	.0020	
	.012	10.651.623	—	—	—	.010-.014	.0020	
	.016	—	10.655.383	11.654.868	11.654.968	.014-.020	.0030	
High Temp. Alloys Titanium, Inconel, Monel	.008	10.651.837	10.655.379	—	—	.006-.010	.0020	125-250
	.012	10.651.737	—	—	—	.010-.014	.0020	
	.016	—	10.655.389	11.654.963	11.654.957	.014-.020	.0030	
Copper Alloys Brass, Bronze	.008	—	11.655.315	—	—	.006-.010	.0015	400-700
	.012	10.651.623	—	—	—	.010-.014	.0020	
	.016	—	11.655.325	11.654.858	11.654.957	.014-.020	.0020	
Aluminum/Magnesium 6061, 7075	.004	10.651.823	—	—	—	.003-.006	.0010	600-1100
	.008	10.651.825	10.655.378	10.654.877	—	.006-.010	.0020	
	.012	10.651.723	—	—	—	.010-.014	.0020	
	.016	10.651.725	10.655.388	10.654.888	10.654.977	.014-.020	.0030	

All cutting data without guarantee

$$\text{Cutting Speed: RPM} = \frac{\text{SFM} \times 3.82}{\text{Bore } \phi}$$

$$\text{Feed Rate: IPM} = \text{RPM} \times \text{IPR}$$

CAUTION

Maximum speed of 310 EWB: 6,600 SFM
Maximum speed of 310 EWN: 4,000 SFM







Light Weight Large Diameter Boring System

Series 318.....Pg. 90-97

Boring Range:

ø7.76"-13.39" for ISO40/HSK-A63 tapers
ø7.76"-24.49" for ISO50/HSK-A100 and larger tapers (extendable up to 118")

Features:

- Cutting speeds up to 6600 SFM
- Versatile system for various applications such as roughing, finishing, pin turning and face grooving
- Coolant supply through all components to the cutting edge
- Absolutely safe mounting of the components on the extension slide for highest safety in operation
- Flanges with CKN connection for highest torque transmission with light weight tools
- High strength and hard coated aluminum components, and nickel coated steel components for scratch resistant and rust protected surfaces
- Accurate balancing without balancing machine by means of two-piece counter weight with slide and scale



Standard Large Diameter Boring System

Series 317.....Pg. 98-101

Boring Range:

ø7.76"-24.41" for ISO50/HSK-A100 and larger tapers

Features:

- Modular system provides versatile performance for heavy roughing, precision finishing and pin turning operations
- Rough boring assemblies can be run in balanced- or stepped-cut configurations and use ISO standard carbide inserts
- Finish boring tools feature micrometer setting precision of .0005" on diameter and adjustable counterweights permit fine balancing of the assembly

Insert Selection & Cutting Data.....Pg. 102-103



SERIES 318 LARGE DIAMETER BORING SYSTEM FLANGES & EXTENSION SLIDES

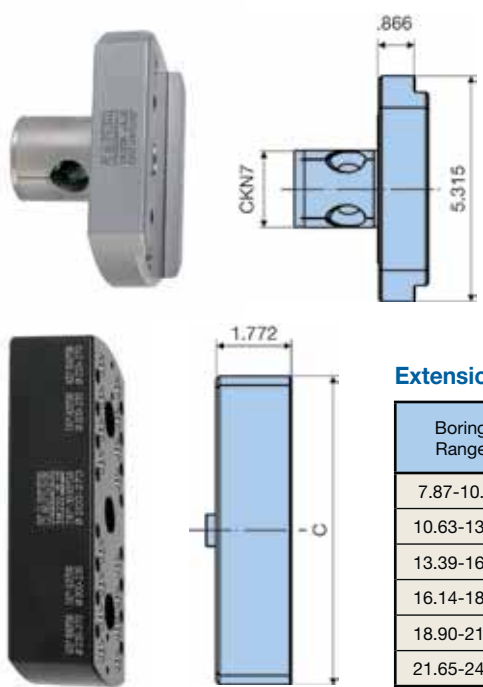

Flange Adapters

Adapter Size	Orientation	Catalog Number
KAB7	0°	10.318.201
CKN7	0°	10.318.201N
KAB7	90°	10.318.202
CKN7	90°	10.318.202N

SPARE PARTS
PG. 95

Extension Slides ø7.87"-24.41"

Boring Range	Catalog Number	C	Max Speed (RPM)
7.87-10.63	10.318.222	7.205	3200
10.63-13.39	10.318.223	9.961	2400
13.39-16.14	10.318.224	12.717	1900
16.14-18.90	10.318.225	15.472	1600
18.90-21.65	10.318.226	18.228	1300
21.65-24.41	10.318.227	20.984	1200

SPARE PARTS
PG. 95



KAB6 & CKN6 Flange Adapters with Extension Slide – ø7.87"-13.39"

The flange with extension slide is made of two pieces. In case of limited space in the tool magazine, it is possible to disassemble the CKN-connector and mount it again with 90° orientation.

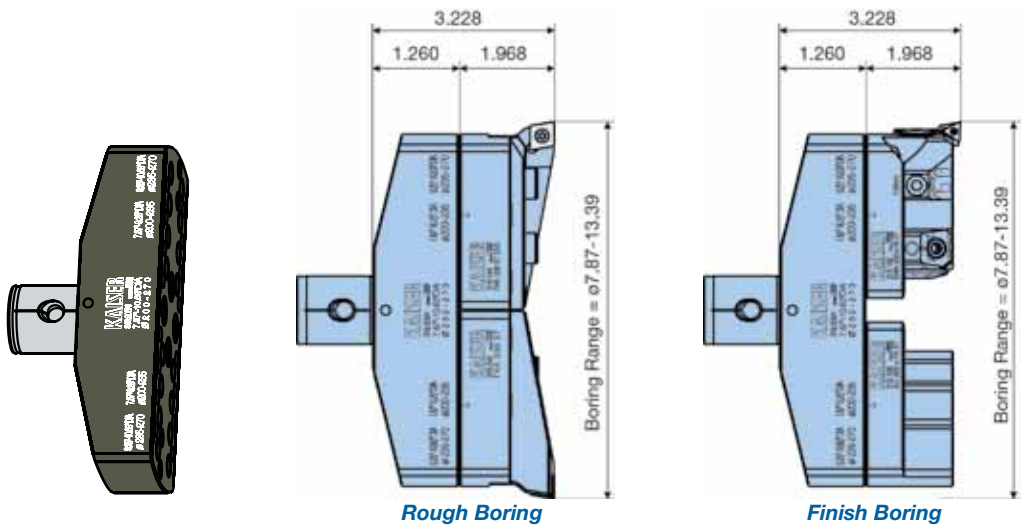

Boring Range	Adapter Size	Catalog Number	C	Max Speed (RPM)
7.87-10.63	KAB6	10.318.205	7.283	3200
7.87-10.63	CKN6	10.318.205N	7.283	3200
10.63-13.39	KAB6	10.318.206	9.252	2400
10.63-13.39	CKN6	10.318.206N	9.252	2400

SPARE PARTS
PG. 95

Component Selection, Assembly & Adjustment for Roughing Tools

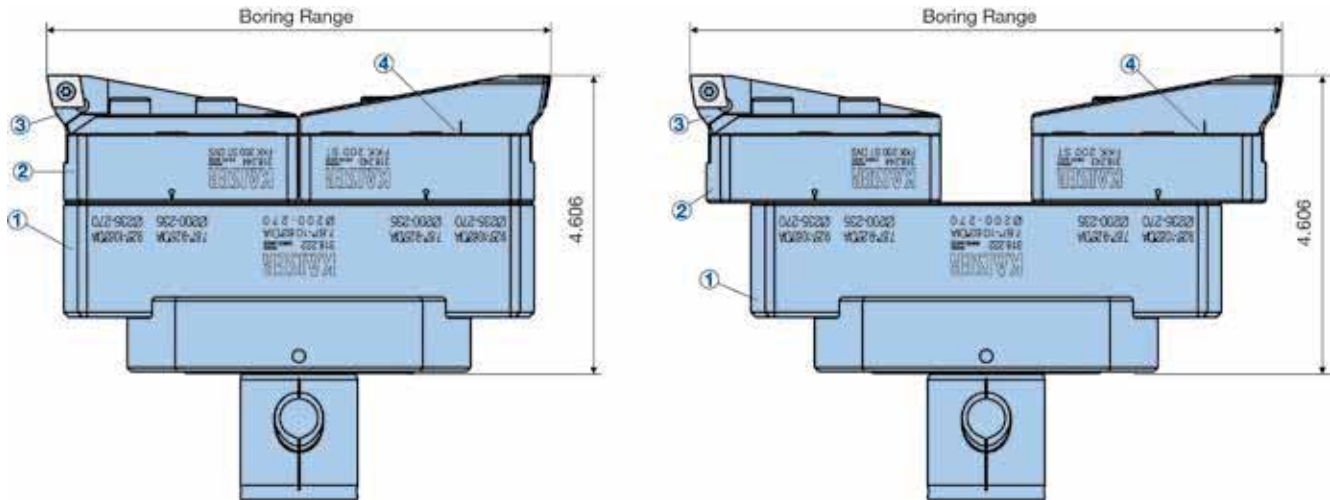

The table below determines the components such as extensions slide ①, clamp base ② and insert holders ③ for each boring diameter range and shows in which position the clamp bases have to be mounted on the extension slide.

Further, this table also serves for the coarse diameter setting of the cutting edges by means of the scale on the clamp base and the marking ④ on the insert holder ③. The required scale value is calculated by the difference between bore diameter and correction factor α . The insert holder has to be adjusted to the scale value. See example below.

Boring Range	Position	Scale Factor α	① Extension Slides	② Clamping Bases	③ Insert Holders
7.756-9.252	1	7.874	10.318.222/10.318.205N	10.318.250 (Inch) 10.318.240 (Metric)	10.637.9xx (See Below) U.S. PATENT 8,747,034
9.134-10.630	2	9.252			
10.512-12.008	1	10.630	10.318.223/10.318.206N		
11.890-13.386	2	12.008			
13.268-14.764	1	13.386	10.318.224		
14.646-16.142	2	14.764	10.318.225		
16.024-17.520	1	16.142			
17.402-18.898	2	17.520	10.318.226		
18.780-20.276	1	18.898			
20.157-21.654	2	20.276	10.318.227		
21.535-23.031	1	21.654			
22.913-24.409	2	23.031			

Example: Diameter setting according to scale

\varnothing : 18.020 Extension slide: 10.318.225 Position: 2 Correction factor α : 17.520
Scale value: $\varnothing - \alpha = 18.020 - 17.520 = .500$

Standard Length: Sold in Pairs

Extended Length: Sold Individually (Used for Stepped Cutting Only)

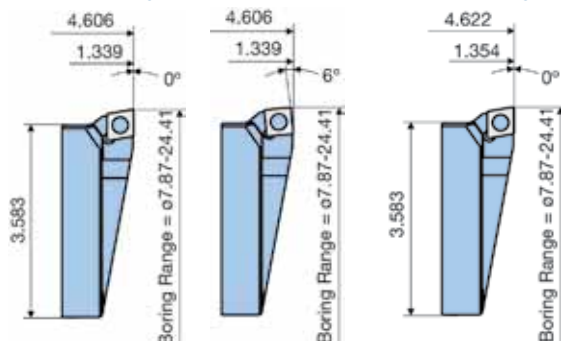

Insert Holders

Type	CC..12	CC..16	SC..12
Standard Length	10.637.940	10.637.941	10.637.942
Extended Length	10.637.951	10.637.953	—

SPARE PARTS
PG. 95

SERIES 318 LARGE DIAMETER BORING SYSTEM INSERT HOLDERS FOR CHAMFERING

Easy Chamfering of Large Diameters

The insert holder with step-less adjustable chamfer angle from 15°-75° is made for front chamfering and also for back chamfering (with limitations) on the lightweight Series 318.

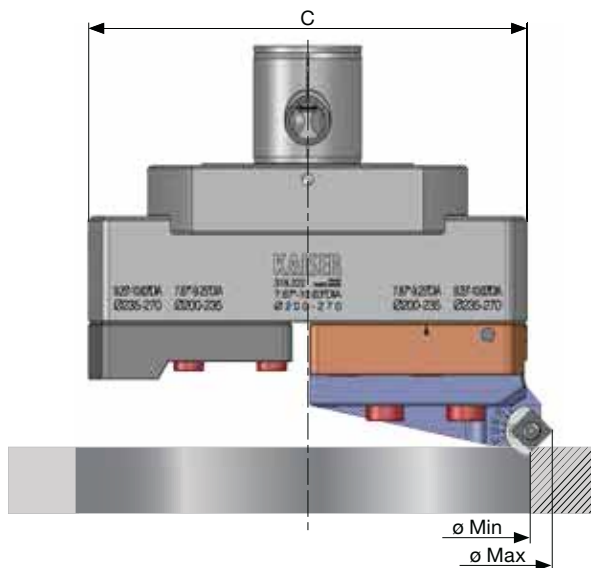
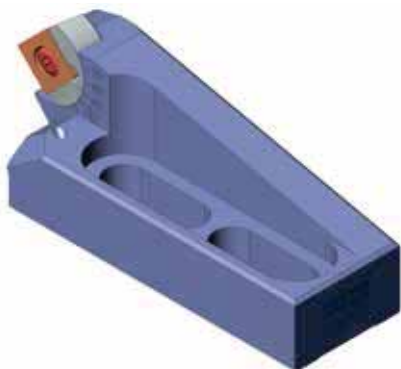

Extension Slide	A = 15°		A = 30°		A = 45°		A = 60°		A = 75°	
	ø Min	ø Max	ø Min	ø Max	ø Min	ø Max	ø Min	ø Max	ø Min	ø Max
10.318.222	7.165	10.866	7.323	10.945	7.480	10.984	7.677	10.945	7.835	10.906
10.318.222	9.921	13.622	10.079	13.701	10.236	13.740	10.433	13.701	10.591	13.661
10.318.222	12.677	16.378	12.835	16.457	12.992	16.496	13.189	16.457	13.346	16.417
10.318.222	15.433	19.134	15.591	19.213	15.748	19.252	15.945	19.213	16.102	19.173
10.318.222	18.189	21.890	18.346	21.969	18.504	22.008	18.701	21.969	18.858	21.929
10.318.222	20.945	24.646	21.102	24.724	21.260	24.764	21.457	24.724	21.614	24.685

SPARE PARTS
PG. 95

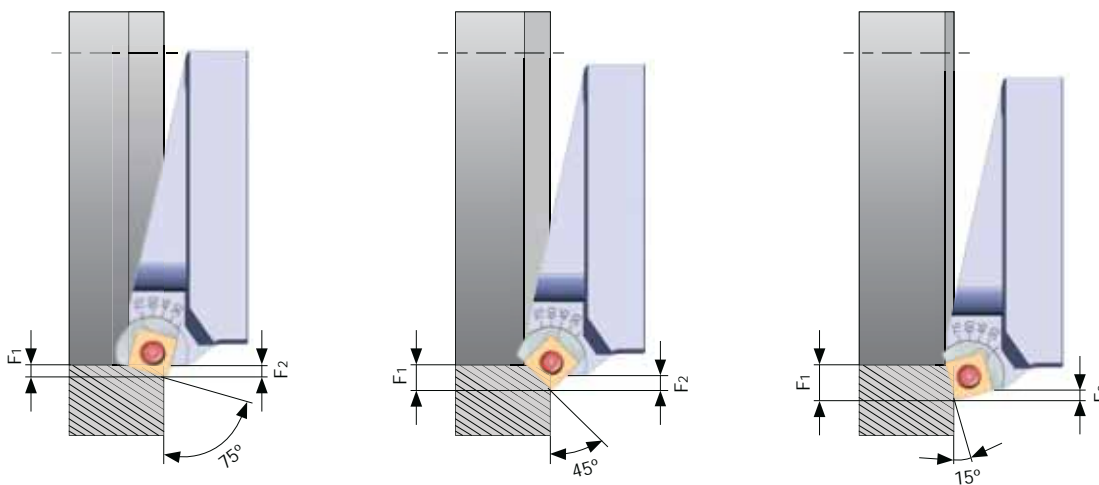

Radial Chamfer Length	A=15°		A=30°		A=45°		A=60°		A=75°	
	F1	F2	F1	F2	F1	F2	F1	F2	F1	F2
	.449	.118	.406	.157	.331	.165	.232	.154	.118	.118



EWD

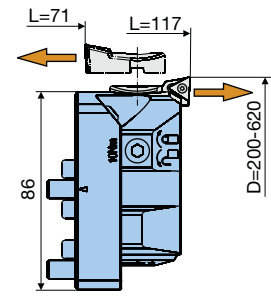

Catalog Number
10.318.113 (inch)
10.318.103 (metric)

• L=Tool length to the KA connection



EWN

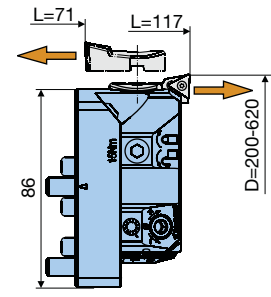

Catalog Number
10.318.111 (inch)
10.318.101 (metric)

• L=Tool length to the KA connection

Catalog Number					
	10.626.271	10.626.272	10.626.273	10.626.371	10.626.372
Type	TC..1102			CC..09T3	

Counterweight

There are two different counterweights available. Type 1 is made of steel and is used for coarse balancing. Type 2 is made of aluminum and contains a slide with a graduated scale for fine balancing of the tool assembly. The scale value is calculated from the balance factor, shown in the table on Pg. 94.

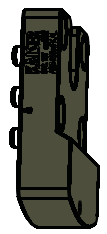

Type 1

Catalog Number
10.318.107



Type 2

Catalog Number
10.318.115 (inch)
10.318.105 (metric)



SERIES 318 LARGE DIAMETER BORING SYSTEM

FINISH BORING $\phi 7.795'' - 24.488''$

Component Selection, Assembly & Balancing for Finishing Tools

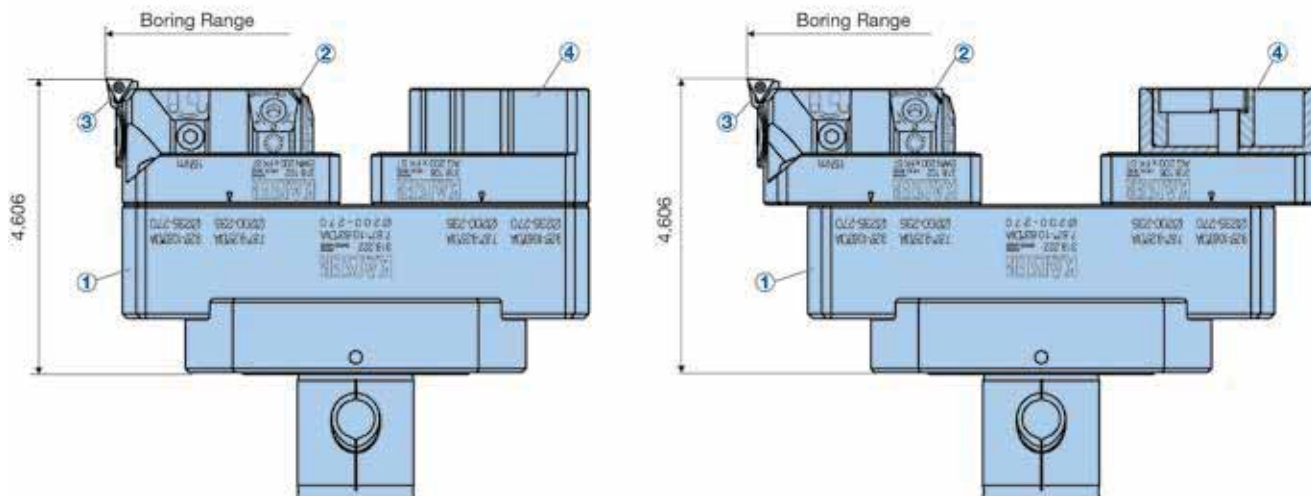

The table below determines the components such as extension slide ①, boring head ②, insert holder ③ and counterweight ④ for each diameter range and shows in which position the boring head and counterweight have to be mounted on the extension slide. Balancing of the tool combination takes place by adjusting the slide on the counterweight according to the scale. The correction factor α is shown in the table. See example below.









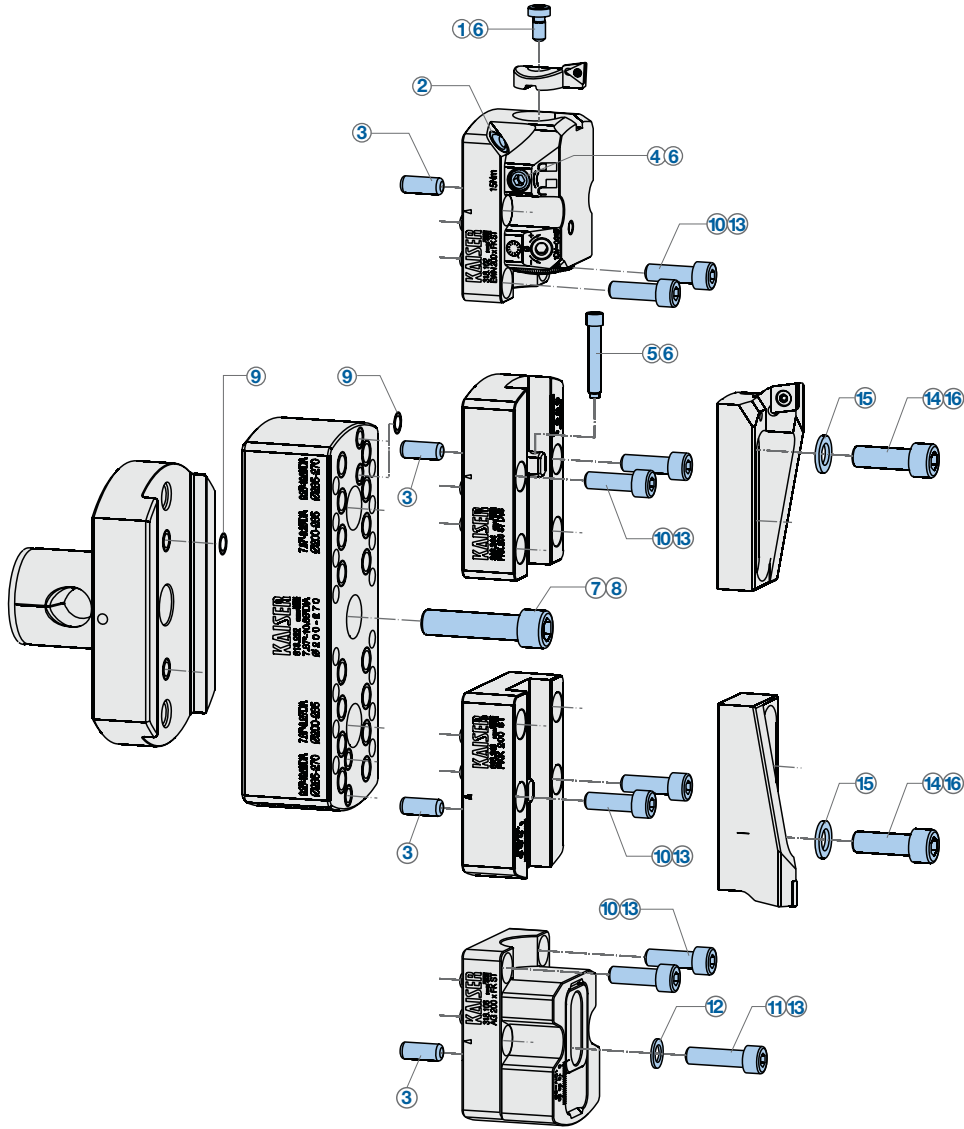

Boring Range	Position	Balance Factor	① Extension Slides	② Boring Heads	③ Insert Holders	④ Counterweights
7.795-9.331	1	7.874	10.318.222/10.318.205N	EWD 10.318.133 (inch) 10.318.103 (metric)	10.626.271 (TC..11) or 10.626.371 (CC..09)	10.318.107 (fixed) or 10.318.115 (inch) 10.318.105 (metric)
9.173-10.709	2	9.252				
10.551-12.087	1	10.630	10.318.223/10.318.206N			
11.929-13.465	2	12.008				
13.307-14.843	1	13.386	10.318.224			
14.685-16.220	2	14.764	10.318.225			
16.063-17.598	1	16.142				
17.441-18.976	2	17.520	10.318.226			
18.819-20.354	1	18.898				
20.197-21.732	2	20.276	10.318.227			
21.575-23.110	1	21.654				
22.953-24.488	2	23.031				

SPARE PARTS
PG. 95 

Example: Diameter setting according to scale

ϕ : 10.880 Extension slide: 10.318.223 Position: 1 Balance factor α : 10.630
 Scale: $\phi - \alpha = 10.880 - 10.630 = .250$



- | | | | |
|---|---|--|--|
|  1 10.690.140
Torque: 11 ft-lbs. |  5 10.317.193 |  9 10.692.295 |  13 10.690.817 |
|  2 10.692.406 |  6 10.690.816 |  10 10.690.140
Torque: 18 ft-lbs. |  14 10.690.105
Torque: 30 ft-lbs. |
|  3 40.691.390 |  7 10.690.121
Torque: 88 ft-lbs. |  11 10.690.124
Torque: 18 ft-lbs. |  15 10.693.184 |
|  4 10.690.553
Torque: 11 ft-lbs. |  8 10.690.134 |  12 10.693.183 |  16 10.690.807 |



SERIES 318 LARGE DIAMETER BORING SYSTEM

EXTENDED BORING RANGE $\phi 24.47'' - 118.15''$

Precision Boring System for Diameters Up to 118"

Five aluminum bridges and five sets of extension slides can be combined in different configurations to offer boring assemblies for the range of $\phi 24.47'' - 118.15''$. Rough boring clamp bases and insert holders, as well as finish boring heads and counterweights, are used from the light weight boring system Series 318. Optional coolant pipes (Pg. 97) offer through-tool coolant supply directly to the cutting edge.

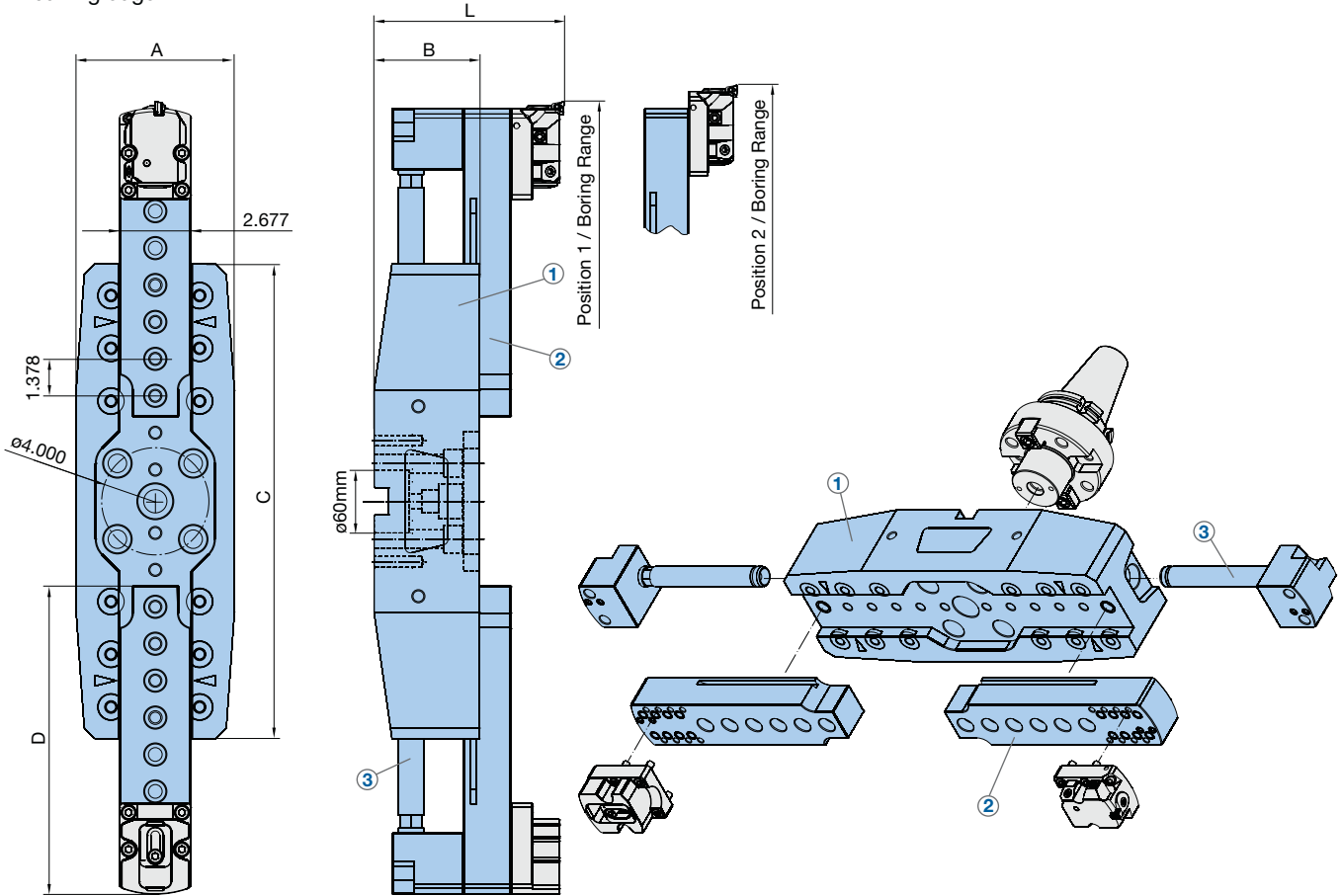

Spindle Mounting Options

Face mill arbors with $\phi 60\text{mm}$ pilot are available in BIG-PLUS® tapers as well as HSK-A100. The CKN7 modular connection is also available, as well as a 50 taper centering plug, for use when the bridge is bolted directly onto the machine spindle (recommended for diameters over 43").

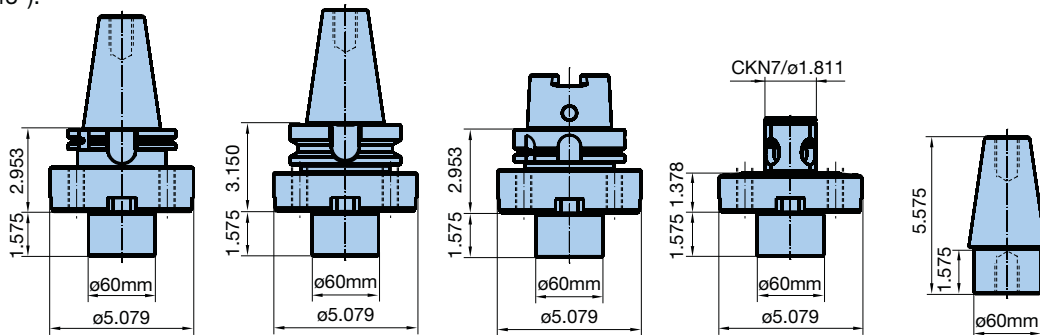

Taper	BCV50	BBT50	HSK-A100	CKN7	ISO50
Catalog Number	BCV50H-FMH60-90	10.328.213	10.328.214	10.328.217N	10.328.216

• Special taper support rings are available upon request

Assembly Component Selection

The table below is used to determine the components required for a specific diameter. The rough and finish boring components (Pg. 91 & 94) can be mounted in two different positions on the extension slide (Pg. 96), and the slides can be mounted in several positions on the bridge (Pg. 96).

Boring Range		① Bridge				② Extension Slide		③ Coolant Pipe
Position 1	Position 2	Catalog Number	A	B	C	Catalog Number	D	Catalog Number
24.37-25.83	25.75-27.20	10.318.421	5.91	3.94	17.72	10.318.431	11.52	10.318.441
27.13-28.58	28.50-29.96							
29.8 -31.34	31.26-32.72							
32.64-34.09	34.02-35.47	10.318.422	5.91	3.94	25.98	10.318.432	15.65	10.318.441
35.39-36.85	36.77-38.23							
38.15-39.61	39.53-40.98							
40.91-42.36	42.28-43.74							
43.66-45.12	45.04-46.50	10.318.423	5.91	3.94	37.01	10.318.433	21.16	10.318.442
46.42-47.87	47.80-49.25							
49.17-50.63	50.55 -52.01							
51.93-53.39	53.31-54.76							
54.69-56.14	56.06-57.52							
57.44-58.90	58.82-60.28							
60.20-61.65	61.57-63.03	10.318.424	6.69	4.72	53.54	10.318.434	25.30	10.318.443
62.95-64.41	64.33-65.79							
65.71-67.17	67.09-68.54							
68.46-69.92	69.84-71.30							
71.22-72.68	72.60-74.06							
73.98-75.43	75.35-76.81							
76.73-78.19	78.11-79.57	10.318.425	7.48	5.12	72.83	10.318.434	25.30	10.318.443
79.49-80.94	80.87-82.32							
82.24-83.70	83.62-85.08							
85.00-86.46	86.38-87.83							
87.76-89.21	89.13-90.59							
90.51-91.97	91.89-93.35							
93.27-94.72	94.65-96.10	10.318.425	7.48	5.12	72.83	10.318.435	45.96	10.318.444
96.02-97.48	97.40-98.86							
98.78-100.24	100.16-101.61							
101.54-102.99	102.91-104.37							
104.29-105.75	105.67-107.13							
107.05-108.50	108.43-109.88							
109.80-111.26	111.18-112.64	10.318.425	7.48	5.12	72.83	10.318.435	45.96	10.318.444
112.56-114.02	113.94-115.39							
115.31-116.77	116.69-118.15							

- Coolant pipes are optional and supply through-tool coolant directly to the cutting edge
- Please consult BIG Kaiser's Engineering Department for component availability



SERIES 317 LARGE DIAMETER BORING SYSTEM FLANGES, EXTENSION SLIDES & COOLANT NOZZLES

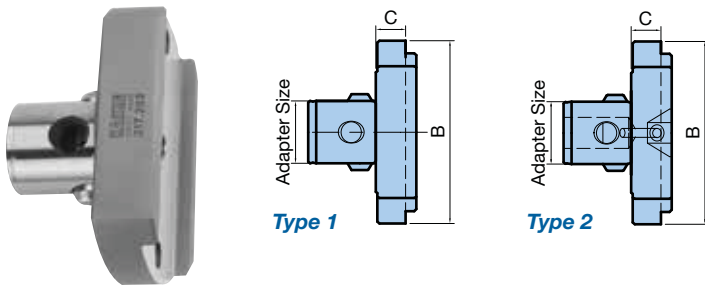

Flange Adapters

Boring Range	Catalog Number	Adapter Size	Type	B	C	Application Description
7.76-24.41	10.317.202†	KAB7	1	5.315	.866	Mid-size to large machines taper size: 45, 50, 50SF, 60
7.76-24.41	10.317.206	KAB7	1	5.315	.866	Same as 10.317.202 except with 90° orientation
7.76-24.41	10.328.086	C8	1	5.315	1.811	Taper size: C8

- Boring range is our recommendation only
- Larger diameters may be possible
- Items marked † are preferred first

Steel Extension Slides

Catalog Number	B	Max Speed (RPM)
10.317.222	7.205	1600
10.317.223	9.961	1200
10.317.224	12.717	900
10.317.225	15.472	750
10.317.226	18.228	650
10.317.227	20.984	600

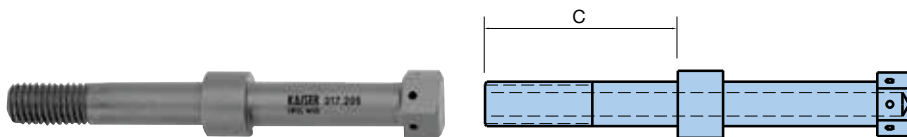
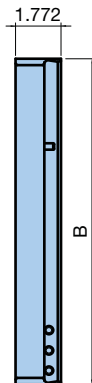

Coolant Nozzle

Catalog Number	C
10.317.205	2.165

Component Selection & Assembly for Roughing Tools

For each extension slide, the boring range is covered by locating clamping bases within 2 positions. Fine adjustment of the insert holders and a graduated scale (inch or metric) permits fast & easy setting of bore diameter.

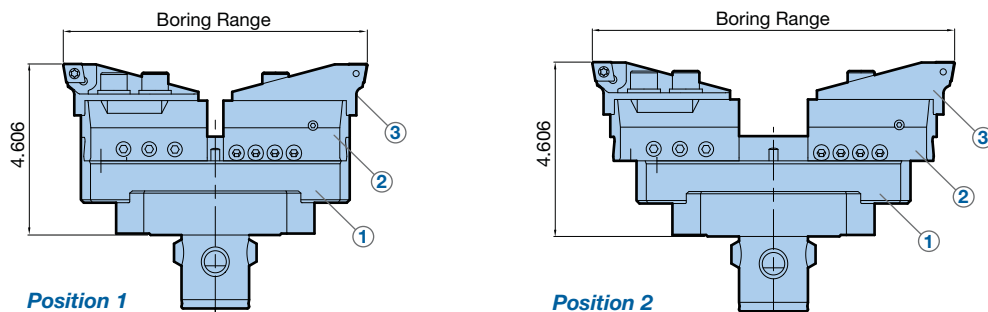

Boring Range A		① Extension Slide	② Clamping Base	
Position 1	Position 2		Inch	Metric
7.76-9.25	9.13-10.63	10.317.222	10.317.291	10.317.289
10.51-12.00	11.89-13.39	10.317.223		
13.27-14.76	14.65-16.14	10.317.224		
16.02-17.52	17.40-18.90	10.317.225		
18.78-20.28	20.16-21.65	10.317.226		
21.54-23.03	22.91-24.41	10.317.227		

SPARE PARTS
PG. 101

Height Setting Shim for Stepped Cutting Method

Catalog Number10.317.287

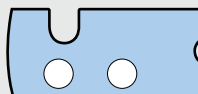

Insert Holders ③

Boring Range				
	CC..12	CC..16	SC..12	WC..08
7.76-24.41	10.637.830	10.637.834	10.637.814	10.637.846
	10.694.150	10.694.150	10.694.150	10.694.143

Clamping Screws (10 screws and 1 wrench per package)

SERIES 317 LARGE DIAMETER BORING SYSTEM

FINISH BORING $\phi 7.795''$ - $25.157''$

Component Selection, Assembly & Balancing for Finishing Tools

For each extension slide, the boring range is covered by 2 positions of finish head and 2 insert holders. Back boring is arranged by reversing the direction of the insert holder. Additional insert holders, such as CC type, can be located on pages 79 & 80.

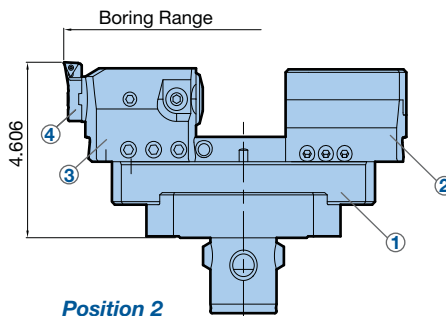
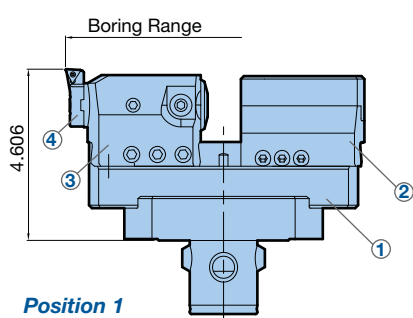

④ TC..11 Insert Holders & Ranges		Position	① Extension Slide	Balance Factor α	② Counter Weight		③ Finish Head	
10.626.161	10.626.162				Inch	Metric	Inch	Metric
7.795-8.976	8.819-10.000	1	10.317.222	7.874	10.317.115	10.317.105	10.317.112A	10.317.102A
9.173-10.354	10.197-11.378	2						
10.551-11.732	11.575-12.756	1	10.317.223	10.630				
11.929-13.110	12.953-14.134	2						
13.307-14.488	14.331-15.512	1	10.317.224	13.380				
14.685-15.866	15.709-16.890	2						
16.063-17.244	17.089-18.268	1	10.317.225	16.142				
17.441-18.622	18.465-19.646	2						
18.819-20.000	19.843-21.024	1	10.317.226	18.898				
20.197-21.378	21.220-22.402	2						
21.575-22.756	22.598-23.780	1	10.317.227	21.654				
22.953-24.134	23.976-25.157	2						

U.S. PATENT
5,857,811

 **10.694.122** Clamping Screws (10 screws and 1 wrench per package)

SPARE PARTS
PG. 101 

Example: Diameter setting according to scale

ϕ : 10.880 Extension slide: 10.317.223 Position: 1 Balance factor α : 10.630
 Scale: $\phi - \alpha = 10.880 - 10.630 = .250$

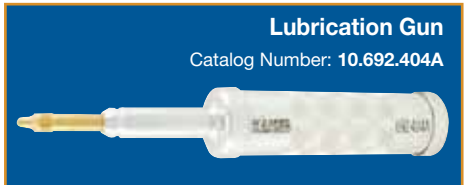
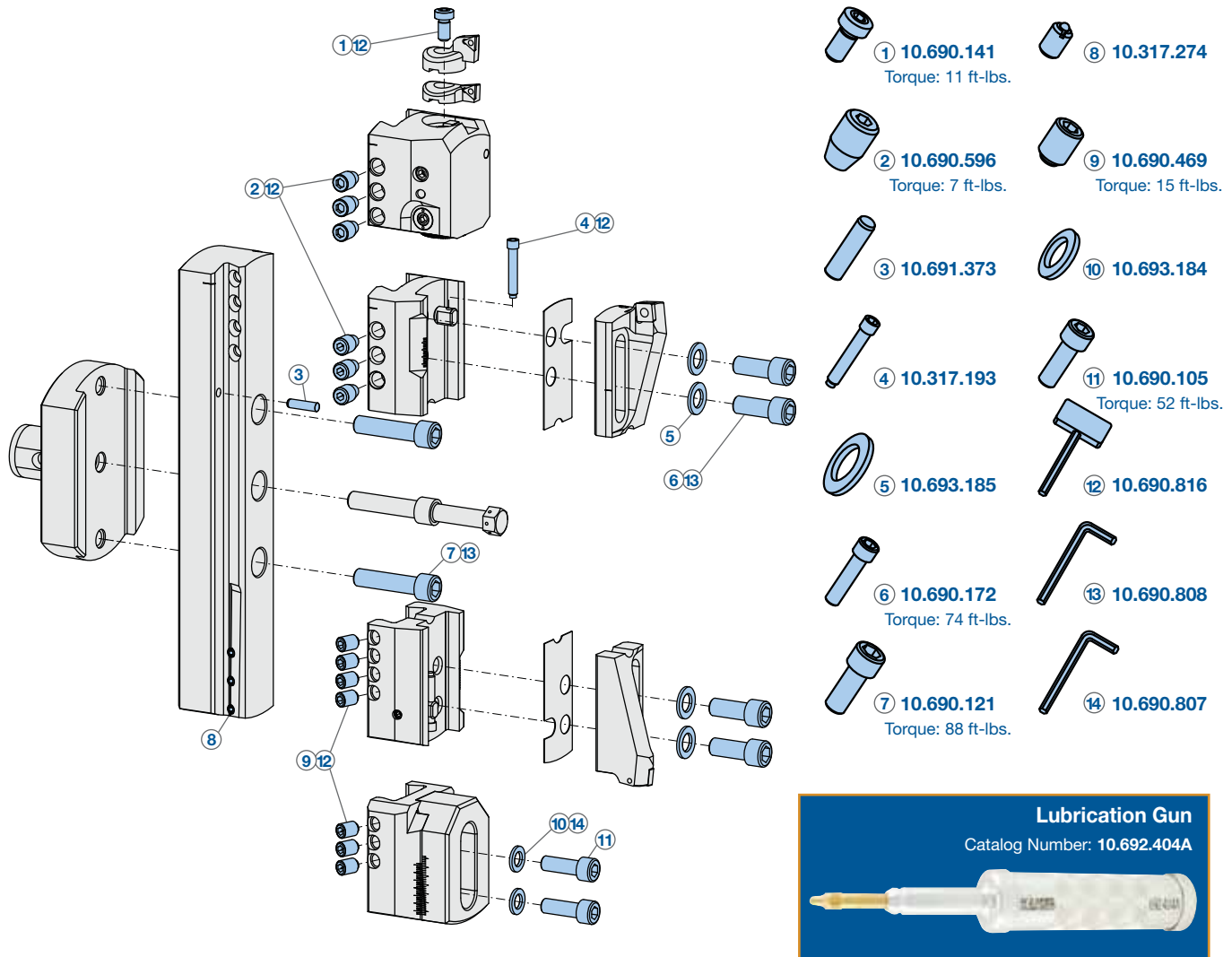

WARNING: Do not exceed maximum RPM as marked on the extension slide!

Finish boring head and counterweight can also mount on the former extension slides without bores for the safety screws. Remove the safety screws ② and align the respective graduation mark on the tool holder with the one on the extension slide.

Finish Boring Notes

Take note that the adjustment range of the tool carrier is limited. Do not use force when adjusting. Periodic lubrication via the lubrication gun ensures high precision combined with long life. A light machine oil is recommended; e.g. Mobile Vactra Oil No. 2, BP Energol HPL-32, Klueber Isoflex PDP 94.

For back boring, counter-clockwise spindle rotation is required.

SERIES 318/317 LARGE DIAMETER BORING SYSTEMS ROUGH BORING INSERT SELECTION & CUTTING DATA



For $\phi 7.76''-24.41''$

Material	Insert Radius	CC..12 (1/2" I.C.)				CC..16 (5/8" I.C.)				SC..12 (1/2" I.C.)		Speed (SFM)			
		Catalog Number	Balanced Cutting		Stepped Cutting		Catalog Number	Balanced Cutting		Stepped Cutting			Catalog Number	Balanced Cutting	
			Feed (IPR)	Max ϕ D.O.C.	Feed (IPR)	Max ϕ D.O.C.		Feed (IPR)	Max ϕ D.O.C.	Feed (IPR)	Max ϕ D.O.C.			Feed (IPR)	Max ϕ D.O.C.
Mild Steels 10XX-15XX 1018, 1020, 1551	.016	11.654.993	.014	.350	.008	.600	—	—	—	—	—	11.654.340	.016	.350	400-825
	.031	11.654.990	.020	.400	.012	.800	11.654.996	.024	.600	.014	1.120	11.654.350	.022	.380	
High Carbon Alloy Steels 23XX-92XX 4130, 4340, 8620	.016	11.654.993	.012	.350	.008	.600	—	—	—	—	—	11.654.340	.014	.350	350-750
	.031	11.654.990	.018	.400	.012	.800	11.654.996	.022	.600	.012	1.120	11.654.350	.020	.380	
300 Series Stainless Steel 304, 316, 17-4ph	.016	—	—	—	—	—	—	—	—	—	—	—	—	—	200-450
	.031	11.654.983	.018	.325	.010	.600	10.654.996	.022	.400	.012	.800	11.654.353	.020	.300	
400 Series Stainless Steel Martensitic	.016	11.654.993	.012	.350	.008	.600	—	—	—	—	—	11.654.340	.014	.350	250-550
	.031	11.654.990	.018	.400	.012	.800	10.654.996	.022	.600	.012	1.120	11.654.350	.020	.380	
Grey Cast Iron Class 30	.016	11.654.993	.014	.500	.008	.800	—	—	—	—	—	11.654.340	.016	.480	300-600
	.031	11.654.971	.020	.600	.012	1.000	11.654.971	.024	.750	.014	1.400	11.654.352	.022	.580	
Silicon Nitride	—	11.654.980	.018	.500	.010	.800	—	—	—	—	—	—	—	—	800-1650
Cast Iron Ductile/Nodular	.016	11.654.993	.012	.450	.008	.700	—	—	—	—	—	11.654.340	.014	.420	250-550
	.031	11.654.971	.018	.500	.500	.900	11.654.971	.022	.675	.012	1.250	11.654.352	.020	.480	
High Temp. Alloys Titanium, Inconel, Monel, etc.	.016	—	—	—	—	—	—	—	—	—	—	11.654.344	.010	.200	100-225
	.031	11.654.978	.014	.280	.007	.500	10.654.997	.016	.380	.008	.700	11.654.359	.014	.250	
Copper Alloys Brass & Bronze	.016	11.654.989	.014	.500	.008	.800	—	—	—	—	—	11.654.344	.016	.480	550-800
	.031	11.654.991	.020	.600	.012	1.000	10.654.997	.024	.750	.014	1.400	11.654.359	.022	.580	
Aluminum & Non-Ferrous	.016	10.654.995	.016	.550	.010	1.000	—	—	—	—	—	—	—	—	825-1300
	.031	10.654.992	.022	.650	.012	1.250	10.654.998	.030	.900	.015	1.625	10.654.387	.022	.650	

All cutting data without guarantee

$$\text{Cutting Speed: } \text{RPM} = \frac{\text{SFM} \times 3.82}{\text{Bore } \phi}$$

$$\text{Feed Rate: } \text{IPM} = \text{RPM} \times \text{IPR}$$

CAUTION ⚠

Do not exceed maximum RPM as marked on the extension slide!



For $\phi 7.795''$ - $25.157''$

Material	Insert Radius	Insert Type & Size		Stock Allowance on Dia.	Feed (IPR)	Speed (SFM)
		TC..11	CC..09			
Mild, Low-Carbon Steel 10XX-15XX 1018,1020,1551, A36	.016	11.655.322	11.654.959	.016-.020	.0040	600-1100
	.031	11.655.332	11.654.960	.024-.040	.0060	
High Carbon Alloy Steels 23XX-92XX Tool Steel 4140, 4340, 8620	.016	11.655.322	11.654.959	.016-.020	.0040	500-900
	.031	11.655.332	11.654.960	.024-.040	.0060	
300 Series Stainless Steel Austenitic 303, 304, 316, 17-4ph	.016	11.655.322	11.654.959	.016-.020	.0040	400-750
	.031	11.655.332	11.654.960	.024-.040	.0060	
400 Series Stainless Steel Martensitic 403, 410, 416, 430	.016	11.655.322	11.654.959	.016-.020	.0040	450-800
	.031	11.655.332	11.654.960	.024-.040	.0060	
Grey Cast Iron Malleable Class 20, 30	.016	10.655.383	11.654.940	.016-.020	.0040	500-1000
	.031	10.655.393	11.654.952	.024-.050	.0060	
CBN-CH, CBN-CHN	—	11.938.833	11.938.838	.008-.016	.0030	1300-1650
Silicon Nitride Si3N4	.031	—	11.654.951	.016-.026	.0050	1500-2000
Cast Iron Ductile/Nodular/Chilled	.016	10.655.302	11.654.940	.016-.020	.0040	350-600
	.031	10.655.303	11.654.952	.024-.040	.0060	
High Temp. Alloys Titanium, Inconel, Monel, etc.	.016	10.655.389	11.654.968	.012-.016	.0020	200-325
	.031	10.655.399	11.654.969	.018-.032	.0030	
Copper Alloys Brass & Bronze	.016	11.655.325	11.654.957	.016-.020	.0040	900-1400
	.031	11.655.335	11.654.958	.024-.050	.0060	
Aluminum/Magnesium 6061, 7075	.016	10.655.387	10.654.977	.016-.020	.0040	1000-1600
	.031	10.655.397	10.654.987	.024-.040	.0060	
Aluminum/Magnesium 6061, 7075 PCD Inserts	.016	10.938.841	11.938.843	.016-.020	.0040	1500-3000
	.031	11.938.860	11.938.851	.024-.050	.0060	
Hardened Steel Min. 50HRc CBN Inserts	.016	10.938.834	11.938.838	.005-.010	.0015	200-300
	.031	10.938.865	—	.006-.012	.0020	

All cutting data without guarantee

Cutting Speed:

$$RPM = \frac{SFM \times 3.82}{Bore \phi}$$

Feed Rate:

$$IPM = RPM \times IPR$$

CAUTION ⚠

Do not exceed maximum RPM as marked on the extension slide!



The KAISER modular tooling system also offers standard solutions for O.D. pin turning on machining centers. The intermediate and large diameter systems allow the use of two TW series heads for balanced roughing and all finish turning assemblies have counterweights available to balance the assembly for higher speed operation.



Series 112 Small Diameter System

Turning Adapter for EWN 2-50XL HeadsPg. 106
 Turning Range: ϕ .039"-1.260" (ϕ 1mm-32mm)



Series 310/315 Intermediate Diameter System

Modular Adapters for EWN/TWN Heads.....Pg. 107
 Turning Range: ϕ .630"-4.724" (ϕ 16mm-120mm)



Series 318 Light Weight Large Diameter System

FinishingPg. 108
 RoughingPg. 109
 Turning Range: ϕ 1.929"-18.740" (ϕ 49mm-476mm)

Series 318 X-Large Diameter System

Bridge Adapters for Series 318Pg. 110
 Turning Range: ϕ 18.465"-112.441" (ϕ 469mm-2,856mm)



SERIES 112 O.D. TURNING SMALL DIAMETER SYSTEM

FINISH TURNING ϕ .039"-1.260"

Through the use of an eccentric turning adapter, the EWN 2-50XL boring head, along with standard insert holders, can turn outside diameters up to ϕ 1.260" on machining centers. Radial adjustment of the insert holder and counterweight allows for concentric location of the turning attachment, resulting in balance of the assembly for high speed operation.

Features:

- Balanced tool assembly for entire work range of ϕ .039"-1.260"
- Through-tool coolant to insert holder
- Fine adjustment of diameter with precision graduated head
- Short, light weight assembly

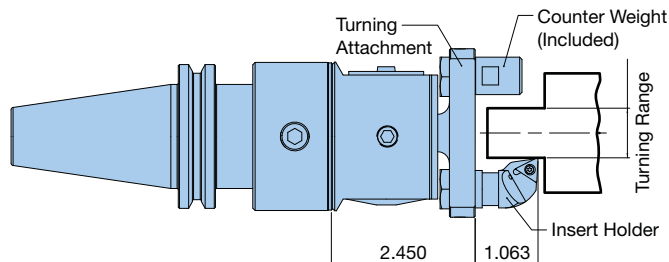

Precision Finish Boring Heads	Turning Attachments	Turning Range	Insert Holders	Extension Pieces	*Counterweights (Included)	Inserts
Inch Boring Head, 10.112.118 1 Div = .0002"/ ϕ	10.615.391 	.039-.236	10.615.292	10.615.228 	10.615.903 	TC..11
		.236-.433	10.615.287			
		.433-.591	10.615.286			
		.591-.787	10.615.285			
Metric Boring Head, 10.112.108 1 Div = .005mm/ ϕ	10.615.390 	.787-.945	10.615.291	10.615.228 	10.615.903 	10.694.122
		.945-1.102	10.615.283			
		1.102-1.260	10.615.282			

*Counterweight included with each turning attachment pre-assembled

CAUTION

Counter-clockwise spindle rotation required.

Modular Adapters for Pin Turning

This program consists of five adapters with KAB5 & KAB6 connectors, made for different turning ranges and with tool connections in the sizes KAB3, KAB4 and KAB5. The corresponding precision or rough boring heads and counterweights can be mounted on the adapter either directly or by means of an extension. With this program, outer diameters in the range from ϕ .630"-4.724" can be machined.

Features:

- Simple and cost effective execution
- Through-tool coolant supply
- Modular construction, extendable for long workpieces
- Suitable for boring operations

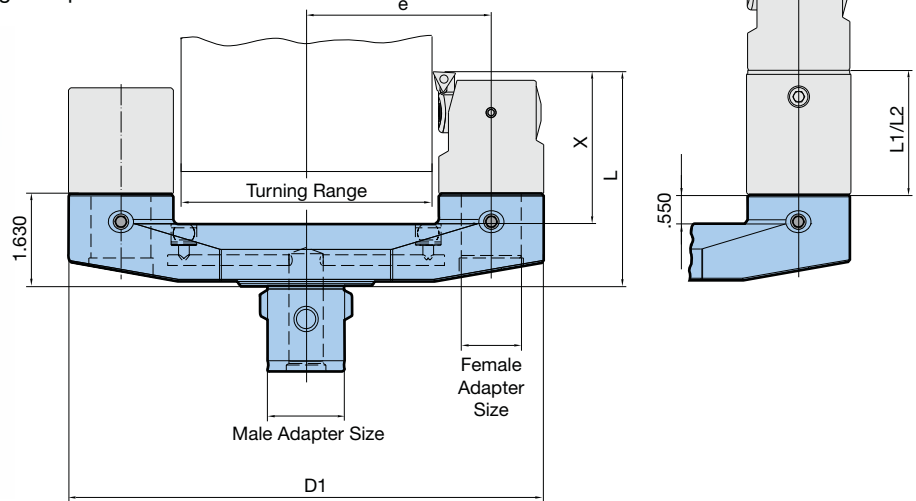

Turning Adapters

Male Adapter Size	Female Adapter Size	Catalog Number	Dimensions				Extensions			
			D1	e	L	X	Catalog Number	L1	Catalog Number	L2
KAB5	KAB3	10.335.906	4.213	1.496	3.268	2.008	11.331.330	1.181	11.331.331	1.771
KAB6	KAB3	10.335.905	4.213	1.496	3.268	2.008	11.331.330	1.181	11.331.331	1.771
KAB6	KAB4	10.335.904	5.787	2.126	3.543	2.283	11.331.440	1.575	11.331.441	2.362
KAB6	KAB4	10.335.903	6.693	2.579	3.543	2.283	11.331.440	1.575	11.331.441	2.362
KAB6	KAB5	10.335.902	8.740	3.406	3.937	2.677	11.331.550	2.362	11.331.551	3.543

Finishing

Turning Adapters	Counterweights	Boring Heads	Insert Holders	Turning Range
10.335.905/ 10.335.906	10.335.915	10.310.311	10.626.133	.630-1.024
			10.626.132	.984-1.378
			10.626.131	1.339-1.732
10.335.904	10.335.913	10.310.411	10.626.143	1.339-1.850
			10.626.142	1.772-2.283
			10.626.141	2.126-2.638
10.335.903	10.335.913	10.310.411	10.626.143	2.244-2.756
			10.626.142	2.677-3.189
			10.626.141	3.031-3.543
10.335.902	10.335.912	10.310.511	10.626.153	3.071-3.740
			10.626.152	3.583-4.252
			10.626.151	4.055-4.724

Roughing

Turning Adapters	Boring Heads*	Insert Holders	Turning Range
10.335.905/ 10.335.906	10.315.301	10.638.432	.984-1.378
		10.638.431	1.339-1.732
10.335.904	10.315.401	10.638.442	1.654-2.165
		10.638.441	2.126-2.638
10.335.903	10.315.401	10.638.442	2.559-3.071
		10.638.441	3.031-3.543
10.335.902	10.315.501	10.638.452	3.425-4.094
		10.638.451	4.055-4.724

*For twin roughing, 2 boring heads & 1 pair of insert holders are required

CAUTION ⚠

Counter-clockwise spindle rotation required.

SERIES 318 O.D. TURNING LARGE DIAMETER SYSTEM

FINISH TURNING $\varnothing 1.929'' - 18.740''$

Modular Slides & Adapters for Finish Pin Turning Large Diameters

The turning adapter with KA5 connection can be mounted on any extension slide. For pin turning, it is required to connect the precision boring head EWN53 x KA5 either directly to the adapter or by means of an extension to the adapter. To compensate the unbalance, a second turning adapter and a special counterweight have to be mounted on the opposite side of the extension slide.

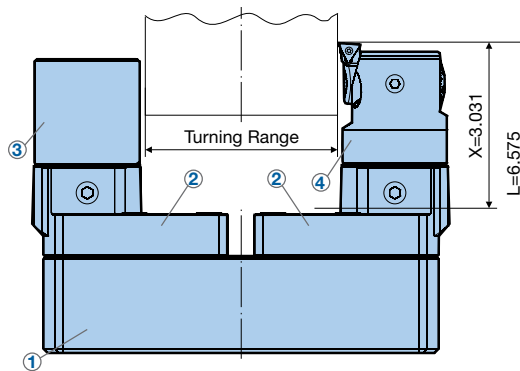

*L = Distance to the KAB connection

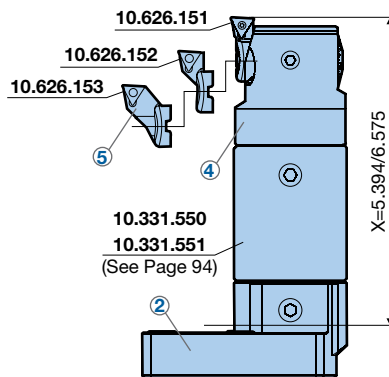

⑤ TC..11 Insert Holders & Ranges			Position	① Extension Slides	② Turning Adapter	③ Counterweight	④ Boring Heads
10.626.153	10.626.152	10.626.151					
1.929-2.598	2.441-3.110	2.913-3.583	1	10.318.222/ 10.318.205	10.318.261 (2 Req'd)	10.317.285	10.310.511 (inch) 10.310.501 (metric)
3.307-3.976	3.819-4.488	4.291-4.961	2				
4.685-5.354	5.197-5.866	5.669-6.339	1				
6.063-6.732	6.575-7.244	7.047-7.717	2				
7.441-8.110	7.953-8.622	8.425-9.094	1				
8.819-9.488	9.331-10.000	9.803-10.472	2				
10.197-10.866	10.709-11.378	11.181-11.850	1				
11.575-12.244	12.087-12.756	12.559-13.228	2				
12.953-13.622	13.465-14.134	13.937-14.606	1	10.318.226			
14.331-15.000	14.843-15.512	15.315-15.984	2				
15.709-16.378	16.220-16.890	16.693-17.362	1	10.318.227			
17.087-17.756	17.598-18.268	18.071-18.740	2				

CAUTION

Counter-clockwise spindle rotation required.

FLANGE ADAPTERS & EXTENSION SLIDES
PG. 90

Modular Slides & Adapters for Rough Pin Turning Large Diameters

The turning adapter with KA5 connection can be mounted on a variety of extension slides to create your diameter. For rough pin turning, it is required to connect two TWN 315 x KA5 either directly to the turning adapter or by means of an extension to the adapter.

NEW!



④ Insert Holder (& Ranges)		Assembly Position	① Extension Slide	② Turning Adapter	③ Boring Head
10.638.452	10.638.451				
2.283-2.953	2.913-3.583	1	10.318.222/10.317.205N	10.318.261 (2 Req'd)	10.315.501 (2 Req'd)
3.661-4.331	4.291-4.961	2			
5.039-5.709	5.669-6.339	1	10.318.223/10.317.206N		
6.417-7.087	7.047-7.717	2			
7.795-8.465	8.425-9.094	1	10.318.224		
9.173-9.843	9.803-10.472	2	10.318.225		
10.551-11.220	11.181-11.850	1			
11.929-12.598	12.559-13.228	2	10.318.226		
13.307-13.976	13.937-14.606	1			
14.685-15.354	15.315-15.984	2	10.318.227		
16.063-16.732	16.693-17.362	1			
17.441-18.110	18.071-18.740	2			

CAUTION ⚠

Counter-clockwise spindle rotation required.

FLANGE ADAPTERS & EXTENSION SLIDES
PG. 90



SERIES 318 O.D. TURNING X-LARGE DIAMETER SYSTEM FINISH TURNING ϕ 18.465"-112.441"

Bridge Tool Holder for X-Large Diameter Pin Turning

NEW!

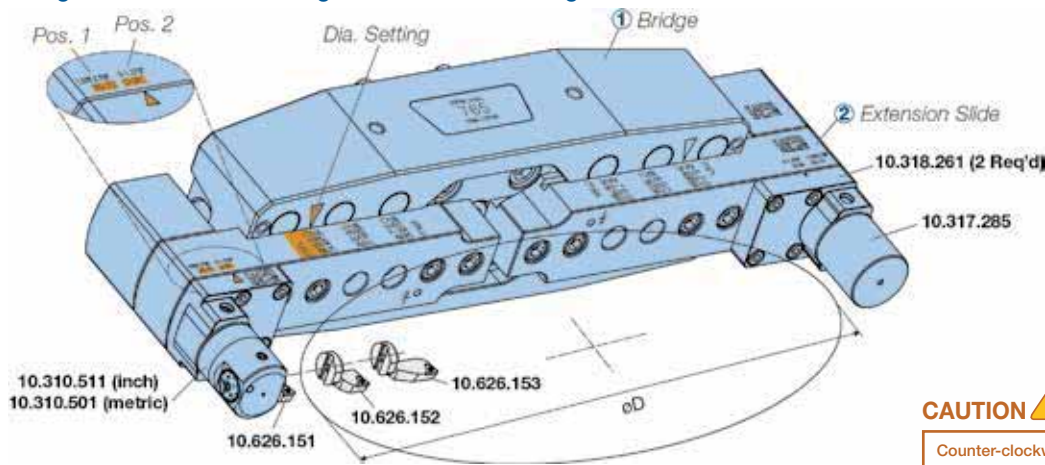

CAUTION ⚠

Counter-clockwise spindle rotation required.

Insert Holder & Turning Range (Position 1)			Insert Holder & Turning Range (Position 2)			Diameter Setting Position	① Bridge	② Extension Slide
10.626.153	10.626.152	10.626.151	10.626.153	10.626.152	10.626.151			
18.465 - 19.134	18.976-19.646	19.449-20.118	19.843-20.512	20.354-21.024	20.827-21.496	620	10.318.421	10.318.431
21.220 - 21.890	21.732-22.402	22.205-22.874	22.598-23.268	23.110-23.780	23.583-24.252	690		
23.976 - 24.646	24.488-25.157	24.961-25.630	25.354-26.024	25.866-26.535	26.339-27.008	760		
26.732-27.402	27.244-27.913	27.717-28.386	28.110-28.780	28.622-29.291	29.094-29.764	830	10.318.422	10.318.432
29.488-30.157	30.000-30.669	30.472-31.142	30.866-31.535	31.378-32.047	31.850-32.520	900		
32.244-32.913	32.756-33.425	33.228-33.898	33.622-34.291	34.134-34.803	34.606-35.276	970		
35.000-35.669	35.512-36.181	35.984-36.654	36.378-37.047	36.890-37.559	37.362-38.031	1040		
37.756-38.425	38.268-38.937	38.740-39.409	39.134-39.803	39.646-40.315	40.118-40.787	1110	10.318.423	10.318.433
40.512-41.181	41.024-41.693	41.496-42.165	41.890-42.559	42.402-43.071	42.874-43.543	1180		
43.268-43.937	43.780-44.449	44.252-44.921	44.646-45.315	45.157-45.827	45.630-46.299	1250		
46.024-46.693	46.535-47.205	47.008-47.677	47.402-48.071	47.913-48.583	48.386-49.055	1320		
48.780-49.449	49.291-49.961	49.764-50.433	50.157-50.827	50.669-51.339	51.142-51.811	1390		
51.535-52.205	52.047-52.717	52.520-53.189	52.913-53.583	53.42554.094	53.898-54.567	1460	10.318.424	10.318.434
54.291-54.961	54.803-55.472	55.276-55.945	55.669-56.339	56.181-56.850	56.654-57.323	1530		
57.047-57.717	57.559-58.228	58.031-58.701	58.425-59.094	58.937-59.606	59.409-60.079	1600		
59.803-60.472	60.315-60.984	60.787-61.457	61.181-61.850	61.693-62.362	62.165-62.835	1670		
62.559-63.228	63.071-63.740	63.543-64.213	63.937-64.606	64.449-65.118	64.921-65.591	1740		
65.315-65.984	65.827-66.496	66.299-66.969	66.693-67.362	67.205-67.874	67.677-68.346	1810		
68.071-68.740	68.583-69.252	69.055-69.724	69.449-70.118	69.961-70.630	70.433-71.102	1880	10.318.425	10.318.434
70.827-71.496	71.339-72.008	71.811-72.480	72.205-72.874	72.717-73.386	73.189-73.858	1950		
73.583-74.252	74.094-74.764	74.567-75.236	74.961-75.630	75.472-76.142	75.945-76.614	2020		
76.339-77.008	76.850-77.520	77.323-77.992	77.717-78.386	78.228-78.898	78.701-79.370	2090		
79.094-79.764	79.606-80.276	80.079-80.748	80.472-81.142	80.984-81.654	81.457-82.126	2160		
81.850-82.520	82.362-83.031	82.835-83.504	83.228-83.898	83.740-84.409	84.213-84.882	2230		
84.606-85.276	85.118-85.787	85.591-86.260	85.984-86.654	86.496-87.165	86.969-87.638	2300		
87.362-88.031	87.874-88.543	88.346-89.016	88.740-89.409	89.252-89.921	89.724-90.394	2370	10.318.425	10.318.435
90.118-90.787	90.630-91.299	91.102-91.772	91.496-92.165	92.008-92.677	92.480-93.150	2440		
92.874-93.543	93.386-94.055	93.858-94.528	94.252-94.921	94.764-95.433	95.236-95.906	2510		
95.630-96.299	96.142-96.811	96.614-97.283	97.008-97.677	97.520-98.189	97.992-98.661	2580		
98.386-99.055	98.898-99.567	99.370-100.039	99.764-100.433	100.276-100.945	100.748-101.417	2650		
101.142-101.811	101.654-102.323	102.126-102.795	102.520-103.189	103.031-103.701	103.504-104.173	2720		
103.898-104.567	104.409-105.079	104.882-105.551	105.276-105.945	105.787-106.457	106.260-106.929	2790		
106.654-107.323	107.165-107.835	107.638-108.307	108.031-108.701	108.543-109.213	109.016-109.685	2860		
109.409-110.079	109.921-110.591	110.394-111.063	110.787-111.457	111.299-111.969	111.772-112.441	2930		

Features

- Especially designed for deep pocket or long reach milling
- Through-tool coolant capability for higher speeds/feeds
- High positive geometry design for reduced vibration & precision cutting

45° Face Milling Cutter

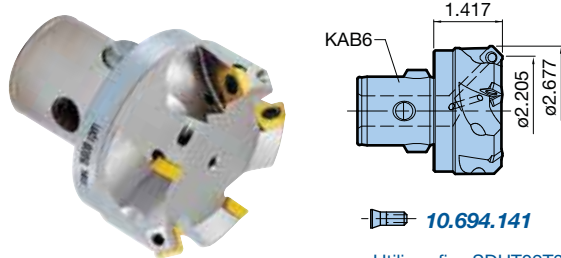

 **10.694.141**

- Utilizes five SDHT09T3 inserts
- 45° geometry for face milling & chamfering

90° Square Shoulder Cutter

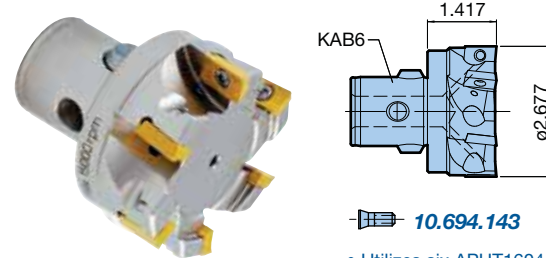

 **10.694.143**

- Utilizes six APHT1604 inserts
- 90° square shoulder milling
- Cutting depth up to .590" possible

Cutters & Inserts

Cutter Type	Catalog Number	Insert Types	Catalog Number	Material
45°	10.335.801	SDHT 09T3AE EN	10.654.230	Steel
		SDHT 09T3AE FN	10.654.231	Aluminum
		SDHW 09T3AE EN	10.654.232	Cast Iron
90°	10.335.802	APHT 1604PD SR	10.655.800	Steel
		APHT 1604PD FR	10.655.801	Aluminum
		APHW 1604PD ER	10.655.802	Cast Iron



MILLING TOOLS FRONT CHAMFERING

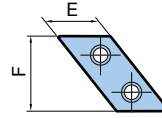
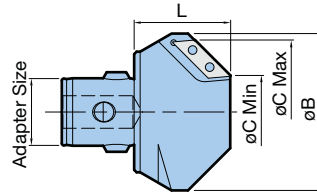

C-Cutter 45° Chamfer Mill

Type	Adapter Size	Catalog Number	øC Min	øC Max	L	øB	Number of Inserts
C0525	KAB2	CKB2-C0525	.197	.984	.984	1.122	1
C1040	KAB4	CKB4-C1040	.394	1.575	1.378	1.772	2
C3060	KAB5	CKB5-C3060	1.181	2.362	1.575	2.559	3
C50100	KAB6	CKB6-C50100	1.969	3.937	2.559	4.173	3

- Wrench and screws are included

C-Cutter Inserts (Sold Individually)

Type	Catalog Number	E	F	Max Chamfer Width	Cutting Speed (SFM)			Feed (IPR)	Insert Screws
					Cast Iron	Steel	Aluminum		
C0525	CW1206A	.250	.500	.079x45°	30-100	65-130	65-130	.004-.006	10.335.035
C1040	CW1909A	.375	.750	.118x45°	65-165	130-250	165-300	.004-.012	10.335.036
C3060	CW1909A	.375	.750	.157x45°	250-500	250-500	300-600	.008-.016	10.335.036
C50100	CW3115A	.375	1.250	.157x45°	250-500	250-500	300-600	.008-.016	10.335.037

- All insert types available with ZX coating; add ZX after catalog number when ordering
- Replacement insert screws available (10 screws and 1 wrench included per package)
- The table is just a reference to determine cutting conditions, and it should be adjusted according to the condition of the machine tool & workpiece

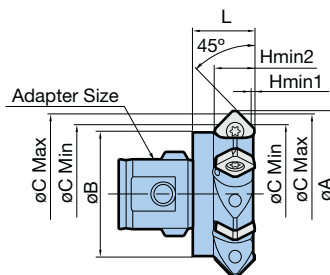

C-Cutter Mini 45° Chamfer Mill

Adapter Size	Catalog Number	øC (Min-Max)	øA	øB	L	Hmin1	Hmin2	No. of Inserts	Insert Type
KAB1	CKB1-C2232-45B-20	.866-1.260	1.287	.748	.787	.012	.488	4	CM10...
KAB3	CKB3-C3242-45B-20	1.260-1.654	1.681	1.220				4	
KAB4	CKB4-C4252-45B-20	1.654-2.047	2.075	1.220				6	
KAB3	CKB3-C5262-45B-20	2.047-2.441	2.469	1.535				6	
KAB5	CKB5-C5262-45B-20	2.047-2.441	2.469	2.008				6	

- Light face milling possible

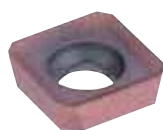

C-Cutter Mini Inserts

Catalog Number	øI.C.	Radius r	Insert Grade		Insert Screws	Anti-Seize Lubricant
			ACP200	DS20		
CM10C1	.394	.008	O	O	S4S-T15	BN-5
CM10C1SE			O	—		

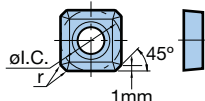

- Inserts are available in packages of 10 pcs.
- Insert screw packages contain 10 screws and 1 wrench
- SE in the catalog number means Sharp Edge type
- Please clarify the insert model and grade when ordering (ex. CM10C1ACP200)

Insert Classifications

ACP200	DS20
<p>For all steel & stainless steel materials</p> <p>Multi-layer PVD coating on carbide base with nanoscale TiAlN & AlCrN. Excellent performance and wear resistance.</p>	<p>For aluminum & non-ferrous materials</p> <p>DLC coating on carbide base with very smooth surface for a low coefficient of friction. Excellent performance against built-up edge.</p>



Newly Introduced SE (Sharp Edge) Type

Sharp edge prevents burrs. Recommended for stainless steel & mild steel.

Cutting Conditions

Material	Insert Grade	Cutting Speed (SFM)	Feed (IPT)		Coolant
			Chamfering	Face Milling	
Carbon Steel	ACP200	330-1155	.002-.016	.002-.008	Dry
Pre-Hardened Steel <HRC40		200-330	.002-.004	.002-.004	Wet
Stainless Steel		330-825	.003-.012	.003-.008	Dry/Wet
Cast Iron		330-1155	.004-.020	.002-.010	Dry
Aluminum/Non-Ferrous	DS20	330-2640	.004-.020	.002-.012	Dry/Wet

- The table is just a reference to determine cutting conditions and it should be adjusted according to the condition of the machine tool and workpiece
- Wet cutting is recommended to obtain a good surface finish
- In case built-up edge occurs cutting aluminum and stainless steel, use soluble oil

MILLING TOOLS CHAMFER RINGS

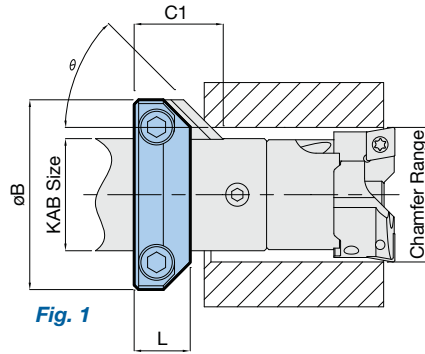

Fig. 1

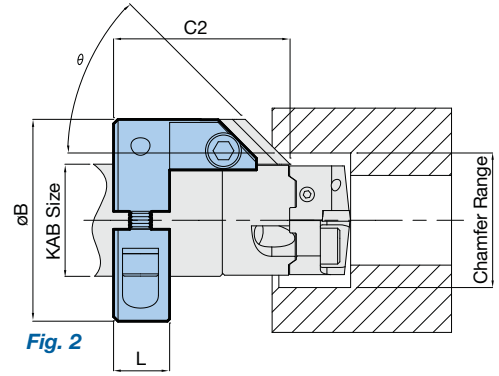
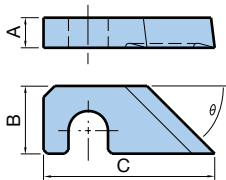

Fig. 2

Chamfer Rings



Adapter Size	Chamfer Range	Catalog Number		θ	C1	C2	L	øB	Insert Size
		Fig. 1	Fig. 2						
KAB1	.79-1.38	10.663.110	—	30°	1.083	—	.511	1.378	1
				45°	.925	—			
KAB2	.98-1.57	10.663.120	10.663.121	30°	1.083	2.146	.590	1.654	
				45°	.925	1.988			
KAB3	1.26-1.85	10.663.130	10.663.131	30°	1.083	2.322	.590	2.008	
				45°	.925	2.165			
KAB4	1.61-2.17	10.663.140	10.663.141	30°	1.083	2.600	.590	2.244	
				45°	.925	2.441			
KAB5	2.09-3.54	10.663.150	10.663.151	30°	2.047	3.582	.984	3.543	2
				45°	1.693	3.228			
KAB6	2.68-4.09	10.663.160	10.663.161	30°	2.047	4.134	.984	4.094	
				45°	1.693	3.780			

Chamfer Ring Inserts



Insert Size	θ	Catalog Number	A	B	C
1	30°	10.663.181	.157	.354	1.083
1	45°	10.663.191	.157	.354	.925
2	30°	10.663.185	.315	.787	2.047
2	45°	10.663.195	.315	.787	1.693

Spare Parts

Adapter Size			
	① Clamp Screws	② Washers	③ Hex Wrench
KAB1	10.690.101	10.693.175	10.690.803
KAB2	10.690.102	10.693.176	10.690.804
KAB3	10.690.103	10.693.176	10.690.804
KAB4	10.690.104	10.693.176	10.690.804
KAB5	10.690.105	10.693.131	10.690.807
KAB6	10.690.106	10.693.131	10.690.807

Cartridges with Micrometer Adjustment for Special, Multi-Diameter Solutions

Special tools with the requirement of high precision adjustment cartridges can be easily designed and manufactured. Five cartridges, offered with either inch ($\phi.0005"/div.$) or metric ($\phi.01mm/div.$) graduated dials cover the diameter work range from $\phi.906"-4.216"$ ($\phi 23mm-107mm$) by application of two different insert holders.

Cartridges are made with a highly accurate and ground micrometer spindle and tool carrier locking system which will not change diameter setting. Cartridges easily assemble into a precision bore and lock securely into place with a threaded locating screw. The locking screw for the tool carrier is an integral part of the locating screw.

Two insert holders for each cartridge are offered and use ISO standard type inserts. Insert holders can be assembled for either forward or back boring without rotating the cartridges. A grease fitting is also provided to ensure long lasting and accurate diameter setting.

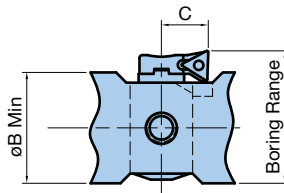

Inch Cartridges, 1 Div = .0005"/ø, ø.906"-4.216"

Type	Catalog Number	øB Min	C	Boring Range	Insert Holder	Insert Type
1/1	10.456.011	.827	.433	.906-1.142	10.626.111	TP..07
				1.102-1.339	10.626.112	TP..07
1/2	10.456.012	1.102	.433	1.299-1.654	10.626.111	TP..07
				1.496-1.811	10.626.112	TP..07
2/1	10.456.013	1.535	.650	1.772 - 2.283	10.626.141	TC..11
				2.126 - 2.638	10.626.142	TC..11
2/2	10.456.014	2.362	.650	2.559 - 3.071	10.626.141	TC..11
				2.913 - 3.425	10.626.142	TC..11
2/3	10.456.015	3.150	.650	3.346 - 3.858	10.626.141	TC..11
				3.701 - 4.216	10.626.142	TC..11

Metric Cartridges, 1 Div = .01mm/ø, ø23mm-107mm

Type	Catalog Number	øB Min	C	Boring Range	Insert Holder	Insert Type
1/1	10.456.001	21	11	23mm-29mm	10.626.111	TP..07
				28mm-34mm	10.626.112	TP..07
1/2	10.456.002	28	11	33mm-42mm	10.626.111	TP..07
				38mm-46mm	10.626.112	TP..07
2/1	10.456.003	39	16.5	45mm-58mm	10.626.141	TC..11
				54mm-67mm	10.626.142	TC..11
2/2	10.456.004	60	16.5	65mm-78mm	10.626.141	TC..11
				74mm-87mm	10.626.142	TC..11
2/3	10.456.005	80	16.5	85mm-98mm	10.626.141	TC..11
				94mm-107mm	10.626.142	TC..11

Type 1

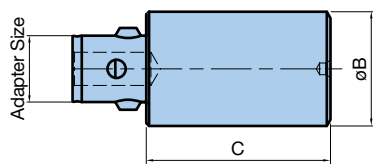

Type 2

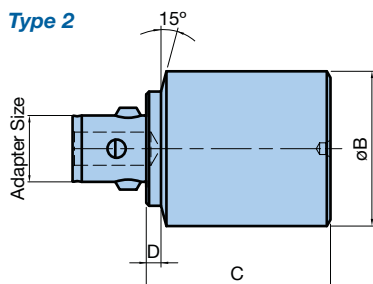

Hardened & Ground Steel KAB Adapters (Steel Blank Machinable RC28-32)

Adapter Size	Type	Catalog Number	øB	C	D
KAB3	1	10.335.531	1.220	2.560	—
KAB3	2	10.335.532	1.654	1.968	.157
KAB4	1	10.335.541	1.535	3.150	—
KAB4	2	10.335.542	2.125	1.968	.157
KAB5	1	11.335.551	1.968	3.937	—
KAB5	2	10.335.552	2.756	2.360	.197
KAB5	2	11.335.553	3.000	6.000	.197
KAB6	1	11.335.563	2.520	8.858	—
KAB6	1	11.335.565	2.520	10.240	—
KAB6	2	11.335.562	3.820	2.760	.394
KAB6	2	11.335.564	4.000	8.000	.394
KAB7	1	11.335.571	3.543	7.087	—
KAB7	2	11.335.572	4.500	8.000	.394

ADJUSTABLE SHELF MOUNT CARTRIDGES TYPE "ASM"

Radial and axial adjustment cartridges allow quick and easy insert adjustments for diameter and length. Especially suitable for use on special multiple diameter roughing and finish boring tools where the highest cutting capacity at high speed and feed can be realized.

The compact design features a unique pivot pin which maintains line contact to the boring bar pocket at all times through the entire range of travel. Adjustments are easily made by turning the screw conveniently located on the front face of the cartridge. Each cartridge can be adjusted in either direction (radially or axially) by up to .024".

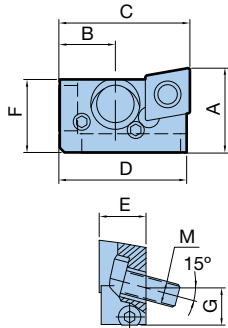

CC..90°

Insert Size	Min. Bore	Catalog Number	A*	B	C	D	E	F	G	M	Gage Insert
CC..06 (1/4" I.C.)	1.260 (32mm)	11.382.316	.512 (13mm)	.335 (8.5mm)	.787 (20mm)	.768 (19.5mm)	.315 (8mm)	.457 (11.6mm)	.225 (5.7mm)	M3x.5	CC..060202
CC..09 (3/8" I.C.)	1.570 (40mm)	11.382.326	.709 (18mm)	.472 (12mm)	1.102 (28mm)	1.075 (27.3mm)	.394 (10mm)	.614 (15.6mm)	.323 (8.2mm)	M5x.8	CC..09T304
CC..12 (1/2" I.C.)	1.970 (50mm)	11.382.346	.866 (22mm)	.472 (12mm)	1.22 (31mm)	1.189 (30.2mm)	.472 (12mm)	.751 (19mm)	.422 (10.7mm)	M6x1	CC..120408
CC..16 (5/8" I.C.)	2.205 (56mm)	11.382.356	1.102 (28mm)	.591 (15mm)	1.496 (38mm)	1.476 (37.5mm)	.472 (12mm)	.992 (25.2mm)	.512 (13mm)	M6x1	CC..160508

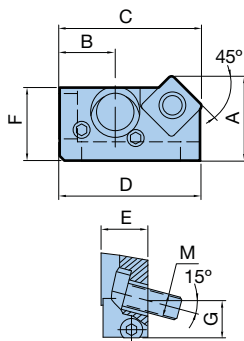

SC..45°

Insert Size	Min. Bore	Catalog Number	A*	B	C*	D	E	F	G	M	Gage Insert
SC..09 (3/8" I.C.)	1.570 (40mm)	11.382.223	.709 (18mm)	.472 (12mm)	1.200 (30.5mm)	1.173 (29.8mm)	.394 (10mm)	.622 (15.8mm)	.323 (8.2mm)	M5x.8	SC..09T304

SC..30°

Insert Size	Min. Bore	Catalog Number	A*	B	C*	D	E	F	G	M	Gage Insert
SC..09 (3/8" I.C.)	1.570 (40mm)	11.382.224	.709 (18mm)	.472 (12mm)	1.200 (30.5mm)	1.173 (29.8mm)	.394 (10mm)	.622 (15.8mm)	.323 (8.2mm)	M5x.8	SC..09T304
SC..12 (1/2" I.C.)	1.970 (50mm)	11.382.244	1.024 (26mm)	.472 (12mm)	1.378 (35mm)	1.366 (34.7mm)	.472 (12mm)	.835 (21.2mm)	.500 (12.7mm)	M6x1	SC..120408

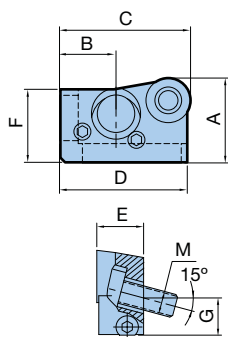

RC

Insert Size	Min. Bore	Catalog Number	A	B	C	D	E	F	G	M	Gage Insert
RC..12 (1/2" I.C.)	1.970 (50mm)	11.382.366	.866 (22mm)	.472 (12mm)	1.220 (31mm)	1.189 (30.2mm)	.472 (12mm)	.751 (19mm)	.422 (10.7mm)	M6x1	RC..120400

*Dimensions based on .016" nose radius for 1/4" & 3/8" I.C. inserts; 1/2" & 5/8" I.C. insert cartridges based on .031" nose radius

FIXED SHELF MOUNT CARTRIDGES TYPE "FSM" & "TSM"



These compact and rigid insert cartridges are best utilized for special multi-diameter roughing and chamfering tools. Combined with other KAISER boring tool components, they can optimize high production boring, facing, or chamfering. Other typical applications are for dedicated core drilling/rough boring operations requiring fixed diameter and length.

Type "FSM" – .030" (.8mm) Adjustment with Shim

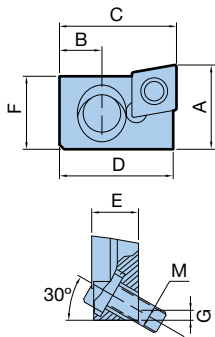

CC..90°

Insert Size	Min Bore	Catalog Number	A*	B	C	D	E	F	G	M	Gage Insert
CC..06 (1/4" I.C.)	1.260 (32mm)	11.381.316	.433 (11mm)	.276 (7mm)	.787 (20mm)	.768 (19.5mm)	.315 (8mm)	.377 (9.6mm)	.035 (.9mm)	M3x.5	CC..060202
CC..09 (3/8" I.C.)	1.570 (40mm)	11.381.326	.670 (17mm)	.295 (7.5mm)	.984 (25mm)	.961 (24.4mm)	.394 (10mm)	.583 (14.8mm)	.084 (2.1mm)	M5x.8	CC..09T304
CC..12 (1/2" I.C.)	1.89 (48mm)	11.381.346	.866 (22mm)	.315 (8mm)	1.181 (30mm)	1.154 (29.3mm)	.472 (12mm)	.751 (19mm)	.151 (3.8mm)	M6x1	CC..120408

SC..45°

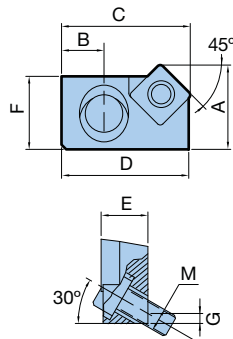

Insert Size	Min Bore	Catalog Number	A*	B	C*	D	E	F	G	M	Gage Insert
SC..09 (3/8" I.C.)	1.570 (40mm)	11.381.223	.670 (17mm)	.295 (7.5mm)	1.023 (26mm)	1.000 (25.4mm)	.394 (10mm)	.583 (14.8mm)	.084 (2.1mm)	M5x.8	SC..09T304
SC..12 (1/2" I.C.)	1.890 (48mm)	11.381.243	.866 (22mm)	.315 (8mm)	1.260 (32mm)	1.232 (31.3mm)	.472 (12mm)	.751 (19mm)	.151 (3.8mm)	M6x1	SC..120408

SC..30°

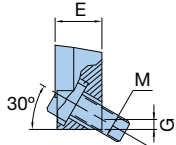

Insert Size	Min Bore	Catalog Number	A*	B	C*	D	E	F	G	M	Gage Insert
SC..09 (3/8" I.C.)	1.570 (40mm)	11.381.224	.670 (17mm)	.295 (7.5mm)	1.023 (26mm)	1.000 (25.4mm)	.394 (10mm)	.583 (14.8mm)	.084 (2.1mm)	M5x.8	SC..09T304
SC..12 (1/2" I.C.)	1.890 (48mm)	11.381.244	.866 (22mm)	.315 (8mm)	1.260 (32mm)	1.232 (31.3mm)	.472 (12mm)	.751 (19mm)	.151 (3.8mm)	M6x1	SC..120408

Type "TSM" – No Adjustment

CC..90°

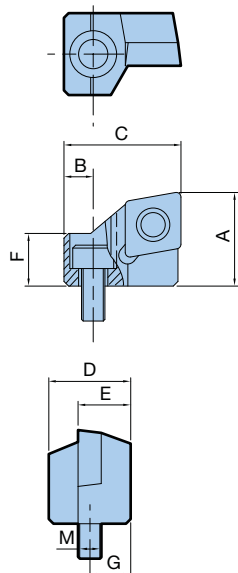

Insert Size	Min Bore	Catalog Number	A*	B	C	D	E	F	G	M	Gage Insert
CC..06 (1/4" I.C.)	1.181 (30mm)	11.381.416	.394 (10mm)	.157 (4mm)	.591 (15mm)	.394 (10mm)	.276 (7mm)	.197 (5mm)	.197 (5mm)	M3x.5	CC..060204
CC..09 (3/8" I.C.)	1.496 (38mm)	11.381.426	.630 (16mm)	.197 (5mm)	.787 (20mm)	.551 (14mm)	.354 (9mm)	.354 (9mm)	.276 (7mm)	M4x.7	CC..09T308
CC..12 (1/2" I.C.)	1.890 (48mm)	11.381.446	.787 (20mm)	.236 (6mm)	.984 (25mm)	.630 (16mm)	.394 (10mm)	.472 (12mm)	.315 (8mm)	M6x1	CC..120408

*Dimensions based on .016" nose radius for 1/4" & 3/8" I.C. inserts; 1/2" I.C. insert cartridges based on .031" nose radius



MODULAR TOOL HOLDERS

END MILL ADAPTERS

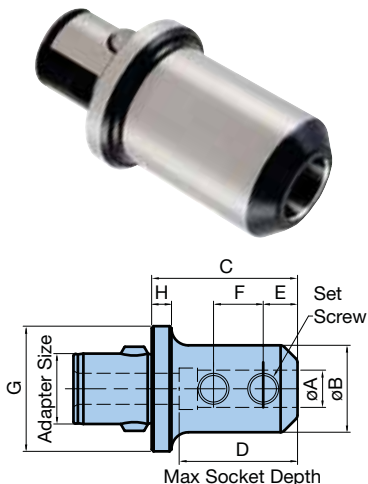

End Mill Adapters – Inch Size

øA	Adapter Size	Catalog Number	øB	C	D	E	F	Set Screws	G	H
.1875	KAB4	11.335.220	.68	1.28	—	.44	—	11.690.517	1.53	.4
.2500	KAB4	11.335.221	.88	1.28	—	.44	—	11.690.517	1.53	.4
.3750	KAB4	11.335.222	1.00	1.78	—	.75	—	11.690.518	1.53	.4
.5000	KAB4	11.335.223	1.25	1.90	1.70	.88	—	11.690.519	1.53	.4
.1875	KAB5	11.335.226	.68	1.28	—	.44	—	11.690.517	1.97	.4
.2500	KAB5	11.335.227	.88	1.28	—	.44	—	11.690.517	1.97	.4
.3750	KAB5	11.335.228	1.00	1.78	—	.75	—	11.690.518	1.97	.4
.5000	KAB5	11.335.229	1.25	1.90	1.79	.88	—	11.690.519	1.97	.4
.7500	KAB5	11.335.231	1.75	3.03	2.75	.94	—	11.690.520	1.97	.4
.1875	KAB6	11.335.201	.68	1.28	—	.44	—	11.690.517	2.52	.4
.2500	KAB6	11.335.202	.88	1.28	—	.44	—	11.690.517	2.52	.4
.3750	KAB6	11.335.203	1.00	1.78	—	.75	—	11.690.518	2.52	.4
.5000	KAB6	11.335.204	1.25	1.90	—	.88	—	11.690.519	2.52	.4
.6250	KAB6	11.335.205	1.50	3.03	—	.94	—	11.690.520	2.52	.4
.7500	KAB6	11.335.206	1.75	3.03	2.75	1.00	—	11.690.521	2.52	.4
.8750	KAB6	11.335.207	1.88	3.03	2.75	1.00	.81	11.690.521 (2)	2.52	.4
1.0000	KAB6	11.335.208	2.00	3.28	2.88	1.12	1.00	11.690.522 (2)	2.52	.4
1.2500	KAB6	11.335.209	2.49	3.28	3.00	1.12	1.00	11.690.522 (2)	2.49	—
1.2500	KAB7	11.335.216	2.50	3.25	3.00	1.12	1.00	11.690.522 (2)	3.54	.5
1.5000	KAB7	11.335.217	2.62	3.25	2.83	1.12	1.00	11.690.522 (2)	3.54	.5
2.0000	KAB7	11.335.218	3.75	4.88	3.75	1.41	1.50	11.690.523 (2)	3.54	—

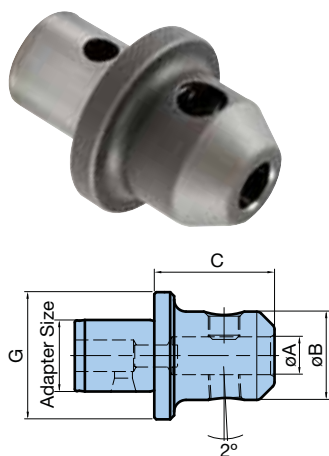

End Mill Adapters – Metric Size

øA	Adapter Size	Catalog Number	øB	C	Set Screws	G
6mm	KA4	10.335.230	24mm	50mm	10.690.477	39mm
8mm	KA4	10.335.231	26mm	50mm	10.690.478	
10mm	KA4	10.335.232	32mm	55mm	10.690.479	
12mm	KA4	10.335.233	39mm	60mm	10.690.480	
6mm	KA5	10.335.234	24mm	50mm	10.690.477	50mm
8mm	KA5	10.335.235	26mm	50mm	10.690.478	
10mm	KA5	10.335.236	32mm	55mm	10.690.479	
12mm	KA5	10.335.237	38mm	60mm	10.690.480	
14mm	KA5	10.335.238	40mm	60mm	10.690.480	
16mm	KA5	10.335.239	45mm	62mm	10.690.481	63.5mm
6mm	KA6	10.335.240	24mm	45mm	10.690.477	
8mm	KA6	10.335.241	26mm	45mm	10.690.478	
10mm	KA6	10.335.242	26mm	45mm	10.690.479	
12mm	KA6	10.335.243	26mm	50mm	10.690.480	
14mm	KA6	10.335.244	26mm	50mm	10.690.480	
16mm	KA6	10.335.245	26mm	50mm	10.690.481	
18mm	KA6	10.335.246	26mm	50mm	10.690.481	
20mm	KA6	10.335.247	26mm	55mm	10.690.482	90mm
25mm	KA6	10.335.248	26mm	65mm	10.690.483	
32mm	KA7	10.335.250**	26mm	80mm	10.690.484	
40mm	KA7	10.335.251**	26mm	90mm	10.690.484	

* Metric size end mill adapters according to both DIN 1835B (Weldon System) and DIN 1835E (Whistle Notch System)
 **Weldon System only

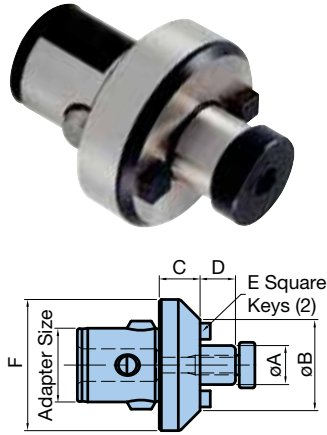

Shell Mill Adapters

øA	Adapter Size	Catalog Number	øB	C	D	E	F	Lock Screws
.50	KAB4	11.335.445	1.53	.71	.56	.25	1.53	11.690.709
.75	KAB4	11.335.446	1.75	.71	.68	.31	—	11.690.710
.50	KAB5	11.335.454	1.44	.78	.56	.25	1.97	11.690.709
.75	KAB5	11.335.455	1.97	.78	.68	.31	1.97	11.690.710
1.00	KAB5	11.335.456	2.25	.78	.68	.38	—	11.690.711
.50	KAB6	11.335.401	1.44	.78	.56	.25	2.52	11.690.709
.75	KAB6	11.335.402	1.75	.78	.68	.31	2.52	11.690.710
1.00	KAB6	11.335.403	2.25	.78	.68	.38	2.52	11.690.711
1.25	KAB6	11.335.404	2.75	1.03	.68	.50	2.52	11.690.712
1.50	KAB6	11.335.405	3.75	1.53	.93	.62	—	11.690.713
1.00	KAB7	11.335.413	2.25	.98	.68	.38	3.54	11.690.711
1.25	KAB7	11.335.414	2.75	.98	.68	.50	3.54	11.690.712
1.50	KAB7	11.335.415	3.75	.98	.93	.62	—	11.690.713
2.00	KAB7	11.335.416	4.88	.98	.93	.75	—	11.691.714

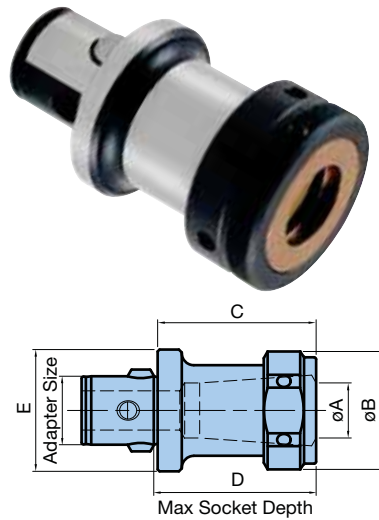

TG Style Angle Collet Chucks

Collet Series	øA Collet Clamping Range	Adapter Size	Catalog Number	øB	C	D	E	Collet Nuts
75TG	.062-.750	KAB6	11.335.106	2.10	2.78	2.20	2.52	11.335.185
100TG	.093-1.000	KAB6	11.335.107	2.50	3.28	2.72	2.52	11.335.186
150TG	.500-1.500	KAB6	11.335.108	3.50	3.78	3.30	2.52	11.335.187
150TG	.500-1.500	KAB7	11.335.114	3.50	4.00	3.50	3.54	11.335.187
200TG	1.000-2.000	KAB7	11.335.115	4.25	4.50	4.06	3.54	11.335.188

- Wrench must be ordered separately
- Collet must be ordered separately
- BIG Kaiser does not offer TG collets

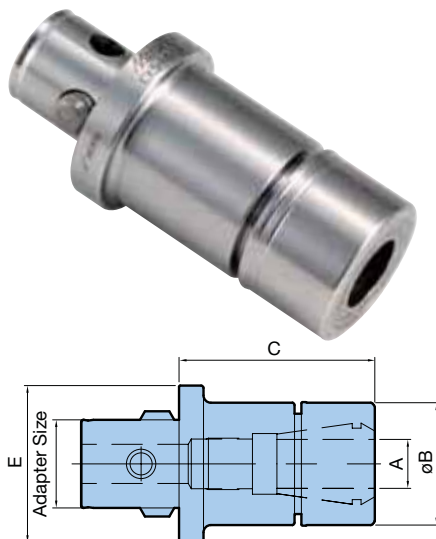

Mega ER Grip Collet Chucks

Collet Series	øA Collet Clamping Range	Adapter Size	Catalog Number	øB	C	E	Wrench
ER16	.075-.394	KA4	CK4-MEGAER16-60	1.181	2.362	1.535	MGR30L
ER20	.108-.512	KA4	CK4-MEGAER20-70	1.378	2.756	1.535	MGR35L
ER25	.108-.630	KA5	CK5-MEGAER25-80	1.654	3.150	1.969	MGR42L
ER32	.108-.787	KA5	CK5-MEGAER32-80	1.969	3.150	1.969	MGR50L
ER32	.108-.787	KA6	CK6-MEGAER32-90	1.969	3.543	2.520	MGR50L

- Mega ER Nut is included
- Adjusting screw, wrench & collet must be ordered separately
- Mega ER Grip is not able to use DIN6499 Form-A collets and ESX collets



For high precision ERC Collets, please see catalog—
BIG Daishowa High Precision Tool Holder Systems

MODULAR TOOL HOLDERS NEW HI-POWER MILLING CHUCKS

Milling Chuck with Needle-Bearing Chucking Nut for Maximum Clamping Force & High Concentricity

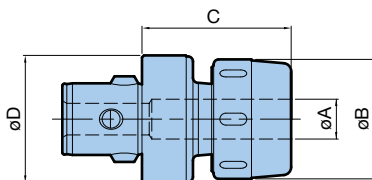

Milling Chuck Adapters – Inch Size

Type	Adapter Size	Catalog Number	Clamping Range	øA	øB	C	øD
HMC.750	KAB6	11.335.067	.25-.75	.75	2.36	2.95	2.52
HMC1.250	KAB7	11.335.078	.25-1.25	1.25	3.15	4.13	3.54

Milling Chuck Adapters – Metric Size

Type	Adapter Size	Catalog Number	Clamping Range	øA	øB	C	øD
HMC20	KAB6	10.335.066	6mm-20mm	20mm	60mm	75mm	64mm
HMC32	KAB7	10.335.077	6mm-32mm	32mm	80mm	105mm	90mm

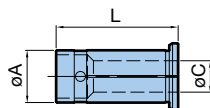

Reduction Sleeves HMC.750 (Inch)

øA	øC Clamping Size	Catalog Number	L
.75	.250	C.750-1/4	2.36
	.312	C.750-5/16	2.36
	.375	C.750-3/8	2.36
	.438	C.750-7/16	2.36
	.500	C.750-1/2	2.36
	.562	C.750-9/16	2.36
	.625	C.750-5/8	2.36

Reduction Sleeves HMC1.250 (Inch)

øA	øC Clamping Size	Catalog Number	L
1.25	.250	C1.250-1/4	2.91
	.312	C1.250-5/16	2.91
	.375	C1.250-3/8	2.91
	.438	C1.250-7/16	2.91
	.500	C1.250-1/2	2.91
	.562	C1.250-9/16	2.91
	.625	C1.250-5/8	2.91
	.688	C1.250-11/16	2.91
	.750	C1.250-3/4	2.91
	.812	C1.250-13/16	2.91
	.875	C1.250-7/8	2.91
	.938	C1.250-15/16	2.91
	1.000	C1.250-1	2.91

Reduction Sleeves HMC20 (Metric)

øA	øC Clamping Size	Catalog Number	L
20mm	6mm	AC20-6	68mm
	8mm	AC20-8	68mm
	10mm	AC20-10	68mm
	12mm	AC20-12	68mm
	16mm	AC20-16	68mm

Reduction Sleeves HMC32 (Metric)

øA	øC Clamping Size	Catalog Number	L
32mm	6mm	AC32-6	90mm
	8mm	AC32-8	90mm
	10mm	AC32-10	90mm
	12mm	AC32-12	90mm
	16mm	AC32-16	90mm
	20mm	AC32-20	90mm
	25mm	AC32-25	90mm



Wrench

Type	Catalog Number
HMC.750, HMC20	FK58-62
HMC1.250, HMC32	FK80-90

Compensates for Synchronization Errors During Rigid Tapping to Improve Thread Quality & Tap Life

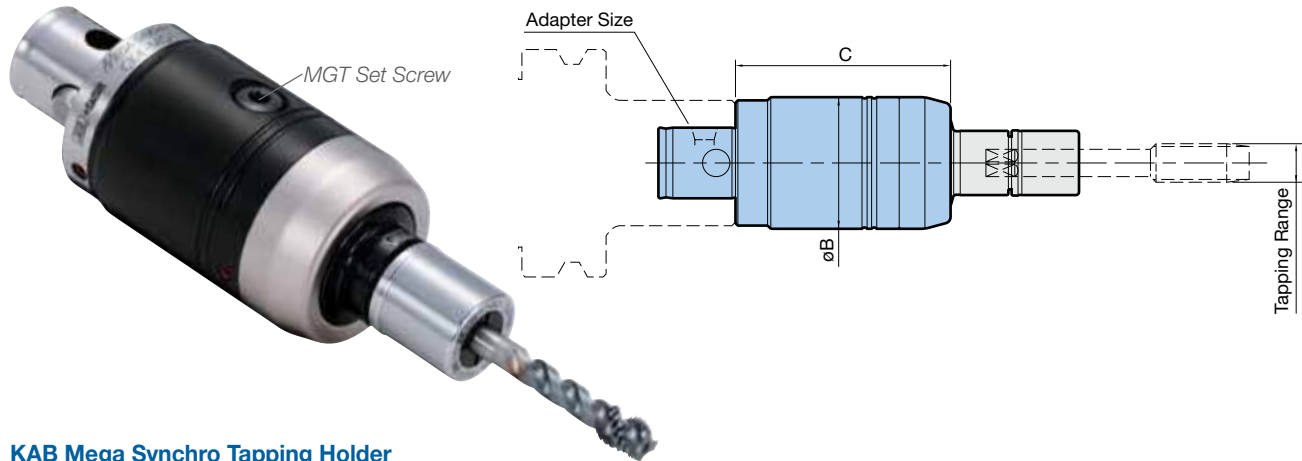

KAB Mega Synchro Tapping Holder

Tapping Range	Adapter Size	Catalog Number	Tap Holder Type	øB	C	MGT Set Screw
No.2-No.12	KAB4	CK4-MGT6-62	MGT6	1.417	2.441	MGT6SS
AU1/4-AU7/16*	KAB4	CK4-MGT12-67	MGT12	1.614	2.638	MGT12SS
AU1/2-AU3/4, AP1/8-AP1/4	KAB5	CK5-MGT20-87	MGT20	2.126	3.425	MGT20SS
AU13/16-AU1-3/8, AP3/8-AP1	KAB7	CK7-MGT36-137	MGT36	3.701	5.394	MGT36SS

- *AU3/8 is included in the MGT20 series
- Tap Holder and wrench must be ordered separately
- Rigid tapping function is required on the machine tool

Load To Tap

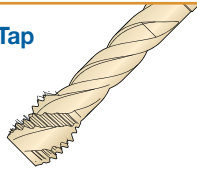

Spiral Tap

AU:1/4-20, N=1,000 RPM
Spiral grooves on spiral tap cause loading in the reverse direction, similar to an end mill.

※ Measured by Kistler Dynamometer

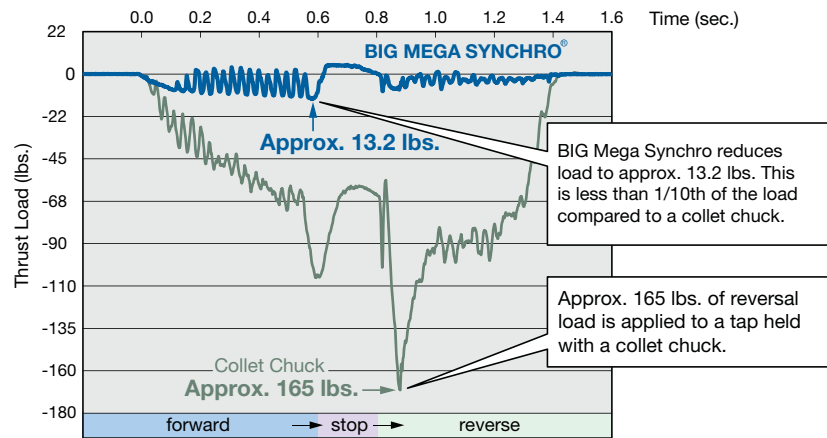

MODULAR TOOL HOLDERS

MEGA SYNCHRO TAPPING HOLDERS

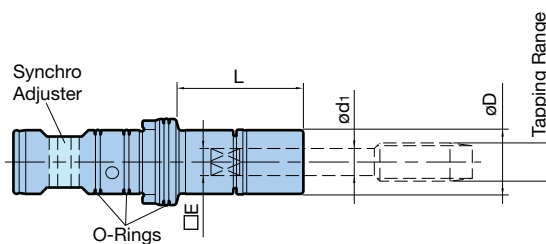

ANSI Standard

Type	Tapping Range	L	Catalog Number	ød1	□E	øD	Clamping Nut	Wrench	Synchro Adapter	O-Ring Set
MGT6	No.2-6	1.250	MGT6-No.6-1.25	.141	.110	.630	MGN6T	MGR16	MGT6SA	MGT6OR
		3.000	MGT6-No.6-3							
		4.000	MGT6-No.6-4							
		6.000	MGT6-No.6-6							
	No.8	1.250	MGT6-No.8-1.25	.168	.131					
		3.000	MGT6-No.8-3							
		4.000	MGT6-No.8-4							
		6.000	MGT6-No.8-6							
	No.10	1.250	MGT6-No.10-1.25	.194	.152					
		3.000	MGT6-No.10-3							
		4.000	MGT6-No.10-4							
		6.000	MGT6-No.10-6							
		8.000	MGT6-No.10-8							
	No.12	1.250	MGT6-No.12-1.25	.220	.165					
		3.000	MGT6-No.12-3							
		4.000	MGT6-No.12-4							
6.000		MGT6-No.12-6								
MGT12	AU1/4	1.250	MGT12-AU1/4-1.25	.255	.191	.787	MGN12T	MGR20	MGT12SA	MGT12OR
		3.000	MGT12-AU1/4-3							
		4.000	MGT12-AU1/4-4							
		6.000	MGT12-AU1/4-6							
		8.000	MGT12-AU1/4-8							
	AU5/16	1.250	MGT12-AU5/16-1.25	.318	.238					
		3.000	MGT12-AU5/16-3							
		4.000	MGT12-AU5/16-4							
		6.000	MGT12-AU5/16-6							
	AU7/16	1.250	MGT12-AU7/16-1.25	.323	.242					
		3.000	MGT12-AU7/16-3							
		4.000	MGT12-AU7/16-4							
		6.000	MGT12-AU7/16-6							
		8.000	MGT12-AU7/16-8							

- Nut is included
- Wrench must be ordered separately
- Tap Holders with other standards such as JIS or DIN are available from stock upon request

Type	Tapping Range	L	Catalog Number	ød1	□E	øD	Clamping Nut	Wrench	Synchro Adapter	O-Ring Set
MGT20	AU3/8	1.500	MGT20-AU3/8-1.5	.381	.286	1.181	MGN20T	MGR30	MGT20SA	MGT20OR
		3.500	MGT20-AU3/8-3.5							
		4.500	MGT20-AU3/8-4.5							
		6.000	MGT20-AU3/8-6							
	AU1/2	1.500	MGT20-AU1/2-1.5	.367	.275					
		3.500	MGT20-AU1/2-3.5							
		4.500	MGT20-AU1/2-4.5							
		6.000	MGT20-AU1/2-6							
	AU9/16	1.500	MGT20-AU9/16-1.5	.429	.322					
		3.500	MGT20-AU9/16-3.5							
		4.500	MGT20-AU9/16-4.5							
		6.000	MGT20-AU9/16-6							
	AU5/8	1.500	MGT20-AU5/8-1.5	.480	.360					
		3.500	MGT20-AU5/8-3.5							
		4.500	MGT20-AU5/8-4.5							
		6.000	MGT20-AU5/8-6							
	AU11/16	1.500	MGT20-AU11/16-1.5	.542	.406					
		3.500	MGT20-AU11/16-3.5							
		4.500	MGT20-AU11/16-4.5							
		6.000	MGT20-AU11/16-6							
	AU3/4	1.500	MGT20-AU3/4-1.5	.590	.442					
		3.500	MGT20-AU3/4-3.5							
		4.500	MGT20-AU3/4-4.5							
		6.000	MGT20-AU3/4-6							
AP1/8	1.500	MGT20-AP1/8-1.5	.437	.328						
	3.500	MGT20-AP1/8-3.5								
	4.500	MGT20-AP1/8-4.5								
	6.000	MGT20-AP1/8-6								
AP1/4	1.500	MGT20-AP1/4-1.5	.562	.421						
	3.500	MGT20-AP1/4-3.5								
	4.500	MGT20-AP1/4-4.5								
	6.000	MGT20-AP1/4-6								

- Nut is included
- Wrench must be ordered separately
- Tap Holders with other standards such as JIS or DIN are available from stock upon request

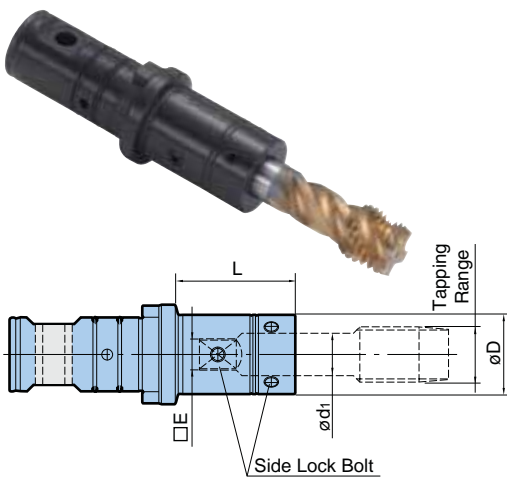

ANSI Standard

Type	Tapping Range	L	Catalog Number	ød1	E	øD
MGT36	AU7/8	2.5	MGT36-AU7/8-2.5	.697	.523	1.34
	AU1		MGT36-AU1-2.5	.800	.600	1.62
	AU1-1/8		MGT36-AU1.1/8-2.5	.896	.672	1.69
	AU1-1/4		MGT36-AU1.1/4-2.5	1.021	.766	1.97
	AU1-3/8		MGT36-AU1.3/8-2.5	1.108	.831	2.09
	AP3/8		MGT36-AP3/8-2.5	.700	.531	1.34
	AP1/2		MGT36-AP1/2-2.5	.688	.515	1.34
	AP3/4		MGT36-AP3/4-2.5	.906	.679	1.69
	AP1		MGT36-AP1-2.5	1.125	.843	2.09

- JIS standard available from stock upon request

MODULAR TOOL HOLDERS

TAPPING ADAPTERS

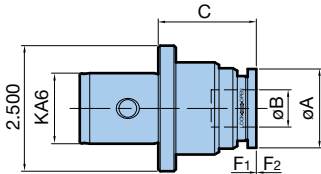

Tension & Compression Tapping Chuck Adapter

Heavy-duty tapping attachments for high production thread cutting on machine tools and machining centers.

Features:

- Extremely short, rigid design
- Large-length compensation in response to tension and compression
- Quick-change clutch for tap holders with or without torque control
- Bilz and Tapmatic compatible

Tapping Chuck Adapter – No Through-Spindle Coolant

Tapping Range	Tap Adapter Size	Catalog Number	øA	øB	C	F1	F2
0-9/16	1	10.335.762	1.850	.748	1.969	.197	.394
5/16-7/8	2	10.335.763	2.520	1.220	3.150	.275	.551

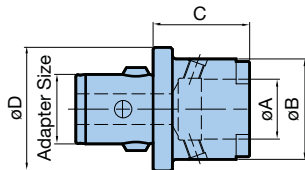

Tapping Adapter for Rigid Tapping

Features:

- Extremely short and compact tapping chuck without axial float
- For tapping on machine tools with speed and feed synchronization
- For quick-change tap holders with or without torque clutch
- Bilz and Tapmatic compatible

Rigid Tapping Adapter

Tapping Range	Tap Adapter	Adapter Size	Catalog Number	øA	øB	C	øD
0-9/16	1	KAB5	11.335.760	.748	1.535	1.181	1.968
0-9/16	1	KAB6	10.335.761	.748	1.535	1.181	2.500
5/16-7/8	2	KAB6	11.335.765	1.220	2.047	1.968	2.500
13/16-1-3/8	3	KAB6	11.335.769	1.890	2.756	2.756	2.500

Torque Control Tap Adapter

Quick-change tap adapter with torque clutch for right hand threads. The overload torque is pre-set according to the thread size and tap standard, and protects the tap against breakage.

Application Use: Blind hole tapping

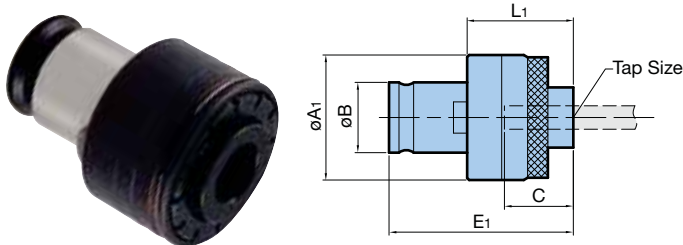

Positive Drive Tap Adapter

Quick-change tap adapter without torque clutch (positive drive) for left and right hand threads.

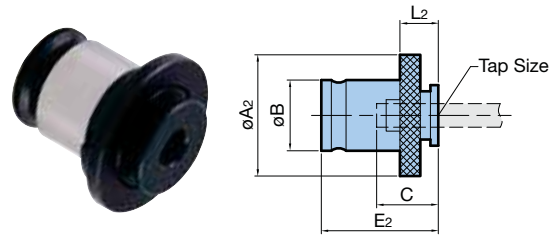

Tap Adapter – Size 1

Tap Size	Torque Control Adapter	Positive Drive Adapter	$\phi A1$	$\phi A2$	ϕB	C	E1	E2	L1	L2
0-6	10.335.660	10.335.630	1.260	1.181	.748	.669	1.830	1.122	.984	.276
8	10.335.661	10.335.631								
10	10.335.662	10.335.632								
12	10.335.663	10.335.633								
1/4	10.335.664	10.335.634								
5/16	10.335.665	10.335.635								
3/8	10.335.666	10.335.636								
7/16	10.335.667	10.335.637								
1/2	10.335.668	10.335.638								
9/16	10.335.669	10.335.639								
1/8 SS	10.335.671	10.335.641								
1/8 LS	10.335.672	10.335.642								

Tap Adapter – Size 2









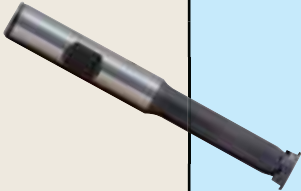
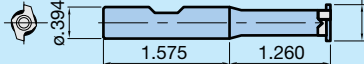
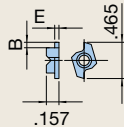

Tap Size	Torque Control Adapter	Positive Drive Adapter	$\phi A1$	$\phi A2$	ϕB	C	E1	E2	L1	L2
5/16	10.335.675	10.335.645	1.970	1.890	1.220	1.181	2.717	1.811	1.339	.433
3/8	10.335.676	10.335.646								
7/16	10.335.677	10.335.647								
1/2	10.335.678	10.335.648								
9/16	10.335.679	10.335.649								
5/8	10.335.680	10.335.650								
11/16	10.335.681	10.335.651								
3/4	10.335.682	10.335.652								
13/16	10.335.683	10.335.653								
7/8	10.335.684	10.335.654								
1/4 P	10.335.686	10.335.656								
3/8 P	10.335.687	10.335.657								
1/2 P	10.335.688	10.335.658								

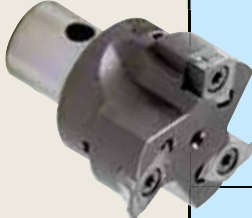
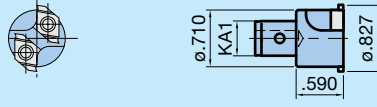
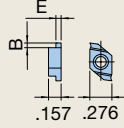

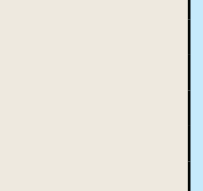
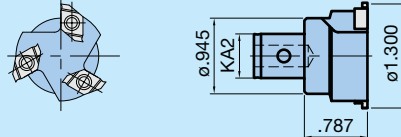
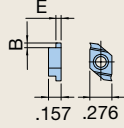
MODULAR TOOL HOLDERS GROOVE MILLING TOOLS

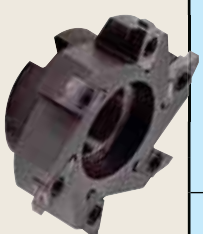
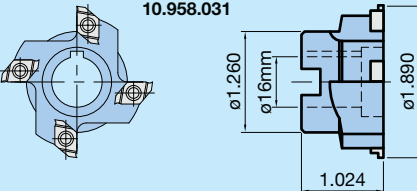
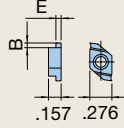
Designed for Circular Milling of Internal or External Grooves

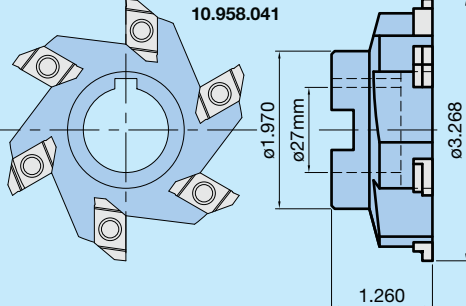
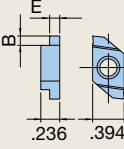
Groove Milling Cutters with Carbide Inserts

	Catalog Number	Insert Type	E	B	Boring Range	Application Code	Catalog Number			
	10.958.008 	Type 0 	.045	.027	.472-.945	ST	10.958.051			
						CI	10.958.052			
						AL	10.958.053			
						-	-	-		10.958.048
									ST	10.958.055
									CI	10.958.056
						.053	.039	.472-.945	AL	10.958.057
									CI	10.958.058
									AL	10.958.059
	10.958.010 	Type 1 	.045	.027	.866-1.340	ST	10.958.061			
						CI	10.958.062			
						AL	10.958.063			
						.053	.039	.866-1.340	ST	10.958.065
									CI	10.958.066
									AL	10.958.067
						-	-	-		10.958.048
									ST	10.958.071
									CI	10.958.072
				10.958.021 	Type 1 	.065	.043	1.340-1.970	AL	10.958.073
									ST	10.958.075
									CI	10.958.076
						.075	.055	1.340-1.970	AL	10.958.077
									CI	10.958.078
									AL	10.958.079
			-	-	-		10.958.048			
						ST	10.958.081			
						CI	10.958.082			
	10.958.031 	Type 1 	.087	.063	1.970-3.350	AL	10.958.083			
						ST	10.958.085			
						CI	10.958.086			
						.106	.075	1.970-3.350	AL	10.958.087
									CI	10.958.088
									AL	10.958.089
			-	-	-		10.958.048			
						ST	10.958.091			
						CI	10.958.092			
	10.958.041 	Type 2 	.126	.082	3.350-8.270	AL	10.958.093			
						ST	10.958.095			
						CI	10.958.096			
						.165	.098	3.350-8.270	AL	10.958.097
									CI	10.958.098
									AL	10.958.099
			-	-	-		10.958.049			

Application Codes

CI.....Cast Iron

ST.....Steel

AL.....Aluminum

.....Clamping Screw (10 screws & 1 wrench)

Groove Milling Tool Adapters

For Groove Mills without KAB tool connection.

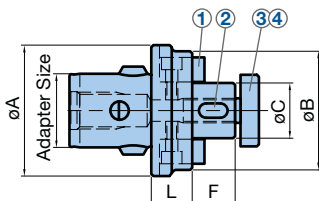

Type	1	2	3	4
	Drive Key	Slotting Key	Mounting Screw	Hex Wrench
16	10.691.605	10.691.600	10.690.703	10.690.805
27	10.690.607	10.691.602	10.690.705	10.690.807

Catalog Number	Type	Adapter Size	øA	øB	øC	L	F
10.335.420	16	KAB4	1.535	1.456	16mm	.709	.669
10.335.423		KAB5	1.970	1.575	16mm	.787	.669
10.335.430		KAB6	2.500	1.575	16mm	.787	.669
10.335.425	27	KAB5	1.970	2.087	27mm	.787	.827
10.335.432		KAB6	2.500	2.283	27mm	.787	.827

Blank Inserts

Periphery ground without rake angle and chip breakers.

Type 0	Grade	Catalog Number	Type 1	Grade	Catalog Number	Type 2	Grade	Catalog Number
 E Max .157 B Max .039	C3	10.958.313	 E Max .157 B Max .075	C3	10.958.157	 E Max .236 B Max .098	C3	10.958.155
	C5	10.958.314		C5	10.958.158		C5	10.958.156

Technical Information:

In all circular milling operations the programmed feed rate S applies to the center of the milling cutter. This may be computed as follows:

$$S = S_1 \times \frac{D-d}{D}$$

Where:
 S = Feed rate for cutter center to be programmed in in/min
 S₁ = Circumferential feed in in/min from table
 D = Bore diameter

Speeds & Feeds

Cutter Dia.	Cutter Speed & Feed			
		Steel: 328 SFM	Cast Iron: 427 SFM	Alum.: 591 SFM
.827	Speed	1500 RPM	2000 RPM	2700 RPM
	S1	11.8 IPM	15.7 IPM	21.3 IPM
1.299	Speed	1000 RPM	1300 RPM	1800 RPM
	S1	11.8 IPM	15.4 IPM	21.3 IPM
1.890	Speed	650 RPM	850 RPM	1200 RPM
	S1	10.2 IPM	13.4 IPM	18.9 IPM
3.268	Speed	380 RPM	500 RPM	700 RPM
	S1	9.0 IPM	11.8 IPM	16.5 IPM

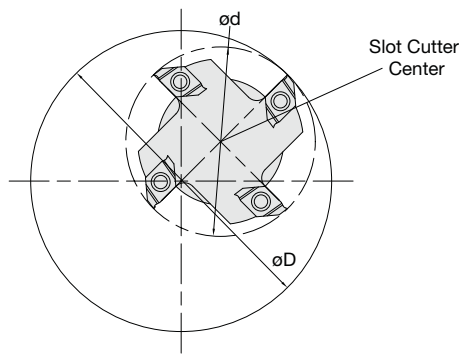

These values relate to the milling cutter circumference and apply under normal working conditions. Climb-cut milling is recommended with helical or tangential plunging to groove depth assuming a continuous program cycle without feed interruption.

CARBIDE INSERTS

GRADE SELECTION & DESCRIPTIONS



KAISER boring tools are designed with replaceable insert holders which permit the use of ISO standard inserts. This feature permits the use of the most varied forms, grades, and geometries offered from a wide variety of manufacturers.

Our insert selection on the following pages contains a large assortment of indexable inserts specially selected for boring with single cutter and twin cutter boring tools. Each insert has been tested and evaluated under the most diverse conditions to meet specific application requirements.

Optimal Conditions:

- Length to diameter ratio less than 4:1
- Good machine spindle
- Rigid fixture and workpiece
- Setup not chatter-prone

Critical Conditions:









- Interrupted cut
- Unstable fixture and/or workpiece
- Excessive spindle looseness
- Setup chatter-prone

Grade Selection

Material	Finish Boring				Rough Boring			
	Optimal Condition		Critical Condition		Optimal Condition		Critical Condition	
	1st choice	2nd choice	1st choice	2nd choice	1st choice	2nd choice	1st choice	2nd choice
Mild Steels 10XX-15XX 1018, 1020, 1551	CT51	TN11	ALCR10	TAN18	TN11	TN12	TN11	TN12
High Carbon-Alloy Steels 23XX-92XX, 4130, 4340, 8620	CT51	TN11	ALCR10	RB10	TN11	TN12	TN12	C2
300 Series Stainless Steel 304, 316, 17-4ph	ALCR10	RB10	TAN18	C2	TN12	RB10	TAN17	C2
400 Series Stainless Steel Martensitic	ALCR10	TN11	TAN18	C2	TN11	RB10	TAN17	C2
Grey Cast Iron Class 30	CBN-CH	CBN-CHN	TAN18	C2	TN14	TAN17	TN14	TAN17
Cast Iron Ductile/Nodular	TAN18	TN11	TAN18	C2	TN14	TAN17	TN14	TAN17
High Temp. Alloys Titanium, Inconel, Monel, etc.	ALCR10	TAN17	ALCR10	C2	TAN17	C2	TAN17	C2
Brass & Bronze	ALCR10	TAN18	C2	C3	C2	—	C2	—
Aluminum	PCD	TAN18	TAN18	C3	C3	—	C3	—
Hardened Steel	CBN	RB10	—	—	—	—	—	—

Insert Grade Descriptions

Grade	Remarks
C2/6	Tough substrate for heavy interruption
C3	Uncoated micro grain with high positive ground/polished chipbreaker
TN11	TiCN, Al ₂ O ₃ , TiN—Superb general purpose roughing & finishing grade
TN12	TiN, TiC, TiN—Extremely tough grade for heavy interruption and stainless steels
TN14	TiCN, Al ₂ O ₃ , TiN—Excellent toughness for heavy roughing and interruption in cast iron
TN15	TiC, Al ₂ O ₃ , TiN—Optimal tool life for outer insert of I.C. drills in carbon steels
TN16	TiC, Al ₂ O ₃ —Optimal tool life for outer insert of I.C. drills in cast irons
TAN17	TiAlN—Good wear resistance in high nickel alloys, i.e. titanium, inconel
TAN18	TiAlN—Excellent wear resistance in steel/cast iron combined w/ ideal edge prep in optimal/critical conditions
ALCR10	ALCrN (Alcrona)—Excellent wear resistance in stainless steel/high nickel alloys combined w/ideal edge prep in optimal/critical conditions
CT51	Cermet—Highest wear resistance for general purpose boring
RB10	Highest achievable hardness, coating gives outstanding life in hardened carbon steels (30-50Rc)
CBN-CH/CBN-CHN	Cubic Boron Nitride—High speed finishing of cast iron combined with excellent wear resistance
PCD	Poly-Crystalline Diamond—High speed finishing of aluminum combined with excellent wear resistance
CBN	Finishing hardened material >50Rc
Si3N4	Silicon Nitride—Roughing/finishing grey cast iron, speeds in excess of 3000 SFM achievable
ALG10	Aluminum Oxide—For most cast irons

Grade & Material Group	Application Codes	Finish Boring			Rough Boring					
		WC..02 	TP..07 	TC..11 	CC..06 	CC..09 	CC..12 	CC..16 	SC..09 	SC..12 
Grade: C2 Uncoated Carbide Cast Iron, Brass, High Temp. Alloys	4, 6	11.655.605 R=.008	-	11.655.315 R=.008	11.654.858 R=.008	11.654.957 R=.016	11.654.989 R=.016	10.654.997 R=.031	11.654.249 R=.016	11.654.344 R=.016
				11.655.325 R=.016	11.654.864 R=.031	11.654.958 R=.031	11.654.991 R=.031		11.654.259 R=.031	11.654.359 R=.031
				11.655.335 R=.031						
Grade: G3 Uncoated Carbide Aluminum, Magnesium	1, 5	10.655.605 R=.004	10.651.823 R=.004	10.655.378 R=.008	10.654.877 R=.008	10.654.977 R=.016	10.654.995 R=.016	10.654.998 R=.031	10.654.277 R=.016	10.654.387 R=.031
		10.655.601 R=.008	10.651.723 R=.012	10.655.388 R=.016	10.654.888 R=.016	10.654.987 R=.031	10.654.992 R=.031		10.654.287 R=.031	
			11.651.923 R=.031	10.655.398 R=.031	11.658.898 R=.031					
Grades: TN11/TN15 Coated Carbide Steel, Cast Iron	1, 2	11.655.607 R=.008	11.651.909 R=.012	11.655.311 R=.008	11.654.840 R=.008	11.654.940 R=.016	11.654.993 R=.016	11.654.996 R=.031	11.654.240 R=.016	11.654.350 R=.016
				11.655.321 R=.016	11.654.850 R=.016	11.654.952 R=.031	11.654.990 R=.031		11.654.250 R=.031	11.654.360 R=.047
				11.655.331 R=.031	11.654.860 R=.031					
Grade: TN12 Coated Carbide Steel, Stainless Steel	3, 4	-	-	11.655.316 R=.016	11.654.853 R=.016	11.654.943 R=.016	11.654.983 R=.031	-	11.654.247 R=.016	11.654.353 R=.031
				11.655.336 R=.031	11.654.869 R=.031	11.654.953 R=.031			11.654.200 R=.031	
Grade: TN14 Coated Carbide Cast Iron	4, 6	-	-	-	11.654.854 R=.016	11.654.956 R=.031	11.654.971 R=.031	11.654.994 R=.031	11.654.252 R=.031	11.654.352 R=.031
Grade: CTP51/52 Cermets Steel, Stainless Steel, Cast Iron	1, 2	10.655.600 R=.008	10.651.802 R=.008	11.656.352 R=.008	11.654.856 R=.008	11.654.959 R=.016	11.654.984 R=.031	-	-	-
		11.655.606 R=.016	10.651.702 R=.016	11.655.322 R=.016	11.654.865 R=.016	11.654.960 R=.031				
				11.655.332 R=.031	11.654.867 R=.031					
Grades: TAN17/TN16 Coated Carbide Cast Iron	5, 6	-	11.651.907 R=.012	11.655.356 R=.008	11.654.868 R=.016	11.654.968 R=.016	11.654.978 R=.031	11.656.370 R=.031	-	11.654.364 R=.031
				11.655.355 R=.016	11.654.969 R=.031					
Grade: TAN18 Coated Carbide Steel, Stainless Steel, Cast Iron, Aluminum	1, 3	10.655.605 R=.004	10.651.824 R=.004	10.655.373 R=.008	11.654.845 R=.016	11.654.974 R=.031	11.654.979 R=.031	-	-	-
		10.655.603 R=.008	10.651.833 R=.008	10.655.383 R=.016						
			10.651.734 R=.016	10.655.393 R=.031						
Grade: ALCR10 Coated Carbide Stainless Steel, High Temp. Alloys	1, 9	10.655.606 R=.004	10.651.837 R=.008	10.655.379 R=.008	-	-	-	-	-	-
		10.655.602 R=.008	10.651.737 R=.012	10.655.389 R=.016						
				10.655.399 R=.031						
Grades: PCD, PCD-CB Poly-Crystalline Diamond, Aluminum, Magnesium	1, 10	11.938.845 R=.008	10.938.840 R=.012	10.938.841 R=.016	11.938.847 R=.008	10.938.843 R=.016	10.938.871 R=.031	-	-	11.654.364 R=.031
			11.938.831 R=.012	11.938.860 R=.031	11.938.842 R=.016	10.938.851 R=.031				
Grades: CBN, CBN-CH Cubic Boron Nitride Cast Iron, Hardened Steel	7, 10	11.938.846 R=.008	10.938.837 R=.012	10.938.834 R=.016	11.938.835 R=.016	11.938.838 R=.016	10.938.862 R=.031	-	-	-
		11.938.863 R=.008	10.938.836 R=.012	10.938.865 R=.031						
Grade: Si3n4 Silicon Nitride Cast Iron	2, 10	-	-	-	11.654.841	11.654.951	11.654.980	-	-	10.688.619

Application Codes

- Normal working conditions, rigid tool combination, workpiece well clamped
- High production boring at high speed under favorable conditions
- Unfavorable conditions, long tools, unstable workpiece or fixtures
- Boring with interrupted cutting, impact loading
- Boring or drilling of non-ferrous materials
- Boring cast iron, nickel based, or high temp. alloys
- Boring of hardened steel alloys (min. Rc50)
- Boring of structural and alloyed steels
- Boring of stainless steels and long chipping materials
- High speed boring

FINISH BORING INSERTS

TYPE WC..02 & TP..07

WC..02

Form 1

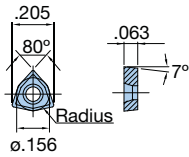

Grade	Radius	Catalog Number	Designation	Rake Angle	Form	Application Code
-------	--------	----------------	-------------	------------	------	------------------

Chip Breakers Pressed

CT51	.008	10.655.600	WC020815C8CTP51	15	1	1, 2
CT51	.016	11.655.606	WC021615C8CTP51	15	1	1, 2
TN11	.008	11.655.607	WC020815C7TNP11	15	1	1, 2
C7	.008	11.655.605	WC020815C7P	15	1	4, 6
RB10	.008	11.655.610	WC020815C7RBP10	15	1	6, 9

Form 2



Chip Breakers Ground

CT51	.004	10.655.604	WC020423C8CTG51	23	1	3
CT51	.008	10.655.601	WC020823C8CTG51	23	1	1, 3
TAN18	.004	10.655.605	WC020423C3TAN18	23	1	3
TAN18	.008	10.655.603	WC020823C3TAN18	23	1	1, 2
ALCR10	.004	10.655.606	WC020423C2ALCR10	23	1	3
ALCR10	.008	10.655.602	WC020823C2ALCR10	23	1	1, 9

PCD & CBN

PCD	.008	11.938.845	WC020800PCD	0	2	1, 10
CBN	.008	11.938.846	WC020800CBN	0	2	7
CBN-CHN	.008	11.938.863	WC020800CBN-CHN	0	2	5, 10

TP..07

Form 1

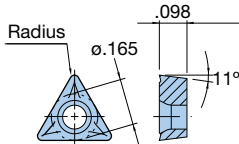

Grade	Radius	Catalog Number	Designation	Rake Angle	Form	Application Code
-------	--------	----------------	-------------	------------	------	------------------

Chip Breakers Pressed

CT51	0.008	10.651.802	TP070815C8CTP51	15	1	1, 2
CT51	0.016	10.651.702	TP071615C8CTP51	15	1	1, 2
TAN17	0.008	10.651.839	TP070815S10TAN17	15	1	2, 4

Chip Breakers Ground

C3	0.004	10.651.823	TP070425C3G	25	2	3
C3	0.008	10.651.825	TP070825C3G	25	2	10
C3	0.012	10.651.723	TP071225C3G	25	2	1, 5
C3	0.016	10.651.725	TP071625C3G	25	2	10
C3	0.031	11.651.923	TP073125C3G	25	2	2, 4
CT51	0.008	10.651.835	TP070815CTG51	15	2	3
CT51	0.012	10.651.736	TP071218CTG51	18	2	3, 4
TAN18/C8	0.008	10.651.833	TP070815C8TAN18	15	2	3, 8
TAN18/C8	0.016	10.651.734	TP071615C8TAN18	15	2	1, 8
TAN18/C3	0.004	10.651.824	TP070425C3TAN18	25	2	3
TAN18/C3	0.012	10.651.735	TP071225C3TAN18	25	2	1, 6
ALCR10	0.008	10.651.837	TP070823C2ALCR10	23	2	3
ALCR10	0.012	10.651.737	TP071223C2ALCR10	23	2	1, 9
TAN17	0.012	11.651.907	TP071210C6TAN17	10	2	6
RB10	0.012	10.651.841	TP071225C3RFBG10	25	2	4, 7

Without Chip Breakers

C3	0.012	10.651.623	TP071205C3G	0	3	1, 4
TAN18/C3	0.012	10.651.632	TP071205C3TAN18	0	3	1, 2

PCD & CBN

PCD	0.012	10.938.840	TP071205PCD	0	4	1, 5
PCD	0.031	11.938.830	TP073100PCD	0	4	1, 5
PCD-CB	0.012	11.938.831	TP071225PCD-CB	25	4	5, 10
CBN	0.012	10.938.837	TP071205CBN	0	4	7
CBN-CH	0.012	10.938.836	TP071205CBN-CH	0	4	1
CBN-CHN	0.012	11.938.872	TP071200CBN-CHN	0	4	3

Form 1

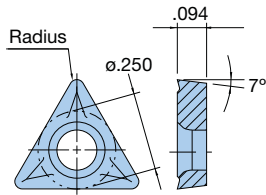

Form 2

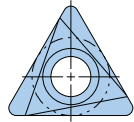

Form 3

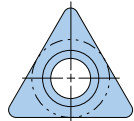

Form 4

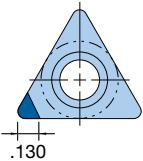

Application Codes

1. Normal working conditions, rigid tool combination, workpiece well clamped
2. High production boring at high speed under favorable conditions
3. Unfavorable conditions, long tools, unstable workpiece or fixtures
4. Boring with interrupted cutting, impact loading
5. Boring or drilling of non-ferrous materials
6. Boring cast iron, nickel based, or high temp. alloys
7. Boring of hardened steel alloys (min. Rc50)
8. Boring of structural and alloyed steels
9. Boring of stainless steels and long chipping materials
10. High speed boring

TC..11

Grade	Radius	Catalog Number	Designation	Rake Angle	Form	Application Code
-------	--------	----------------	-------------	------------	------	------------------

Chip Breakers Pressed

C2	.008	11.655.315	TC110815C2P	15	1	3, 6
C2	.016	11.655.325	TC111615C2P	15	1	4, 6
C2	.031	11.655.335	TC113115C2P	15	1	4, 6
CT51	.008	11.656.352	TC110815C8CTP51	15	1	3, 8
CT51	.016	11.655.322	TC111615C8CTP51	15	1	2
CT51	.031	11.655.332	TC113115C8CTP51	15	1	2
CT51	.016	11.655.327	TC111615C8CTP51W	15	1	1, 2
TN11	.008	11.655.311	TC110815C7TNP11	15	1	3, 8
TN11	.016	11.655.321	TC111615C7TNP11	15	1	1, 8
TN11	.031	11.655.331	TC113115C7TNP11	15	1	1, 8
TN12	.016	11.655.316	TC111615C5TNP12	15	1	4
TN12	.031	11.655.336	TC113115C5TNP12	15	1	4
TAN17	.008	11.655.356	TC110815C2TAN17	15	1	6
TAN17	.016	11.655.355	TC111615C2TAN17	15	1	6
TAN17	.016	10.655.326	TC111615S10TAN17	15	1	2, 4
RB10	.016	11.655.370	TC111615C2RBP10	15	1	4, 7

Chip Breakers Ground

C3	.008	10.655.378	TC110823C3G	23	2	3
C3	.016	10.655.388	TC111623C3G	23	2	3
C3	.016	10.655.387	TC111620C3G	20	2	10
C3	.031	10.655.398	TC113123C3G	23	2	1
C3	.031	10.655.397	TC113120C3G	20	2	10
CT51	.008	10.655.372	TC110815CTG51	15	2	3
CT51	.016	10.655.386	TC111618CTG51	18	2	3, 4
TAN18/C8	.008	10.655.371	TC110815C8TAN18	15	2	3, 8
TAN18/C8	.016	10.655.381	TC111615C8TAN18	15	2	1, 8
TAN18/C3	.004	10.655.363	TC110423C3TAN18	23	2	3
TAN18/C3	.008	10.655.373	TC110823C3TAN18	23	2	1, 6
TAN18/C3	.016	10.655.383	TC111623C3TAN18	23	2	2
TAN18/C3	.031	10.655.393	TC113123C3TAN18	23	2	2
ALCR10	.008	10.655.379	TC110823C2ALCR10	23	2	3
ALCR10	.016	10.655.389	TC111623C2ALCR10	23	2	1, 9
ALCR10	.031	10.655.399	TC113123C2ALCR10	23	2	1, 9
RB10	.016	11.655.371	TC111623C3RBG10	23	2	3, 7

Without Chip Breakers

C3	.016	10.655.305	TC111600C3G	0	3	1, 4
C3	.031	10.655.306	TC113100C3G	0	3	1
AL10	.008	10.655.301	TC110800C3ALG10	0	3	3
AL10	.016	10.655.302	TC111600C3ALG10	0	3	1
AL10	.031	10.655.303A	TC113100C3ALG10	0	3	2

PCD & CBN

PCD	.008	11.938.861	TC110805PCD	0	4	1, 5
PCD	.016	10.938.841	TC111605PCD	0	4	1, 5
PCD	.031	11.938.860	TC113100PCD	0	4	2, 10
PCD-CB	.016	11.938.832	TC111625PCD-CB	25	4	5, 10
PCD	.031	11.938.873	TC113100PCDW	0	4	2, 10
CBN	.016	10.938.834	TC111605CBN	0	4	7
CBN	.031	11.938.865	TC113100CBN	0	4	7
CBN-CH	.016	11.938.833	TC111605CBN-CH	0	4	1
CBN-CH	.031	11.938.849	TC113100CBN-CH	0	4	1
CBN-CHN	.016	11.938.864	TC111600CBN-CHN	0	4	3

ROUGH BORING INSERTS TYPE CC..06 & CC..09

Form 1

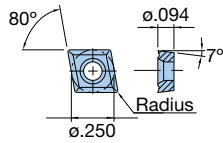

Form 2



Form 3



Form 4

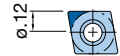

Form 5



CC..06

Grade	Radius	Catalog Number	Designation	Rake Angle	Form	Application Code
-------	--------	----------------	-------------	------------	------	------------------

Chip Breakers Presssed

C2	0.016	11.654.858	CC061615C2P	15	1	4, 6
C2	0.031	11.654.864	CC063115C2P	15	1	4, 6
CT52	0.008	11.654.856	CC060815C7CTP52	15	1	3, 8
CT51	0.016	11.654.865	CC061615C8CTP51	15	1	2
CT51	0.031	11.654.867	CC063115C8CTP51	15	1	2
TN11	0.008	11.654.840	CC060815C7TNP11	15	1	3, 8
TN11	0.016	11.654.850	CC061615C7TNP11	15	1	1, 8
TN11	0.031	11.654.860	CC063115C7TNP11	15	1	1, 8
TN12	0.016	11.654.853	CC061615C5TNP12	15	1	4
TN12	0.031	11.654.869	CC063115C5TNP12	15	1	4
TAN17	0.016	11.654.868	CC061615C2TAN17	15	1	6
RB10	0.016	11.654.963	CC061615C2RBP10	15	1	4, 7
TAN17	0.016	11.655.355	TC111615C2TAN17	15	1	6
RB10	0.016	11.655.370	TC111615C2RBP10	15	1	4, 7

Chip Breakers Ground

C3	0.008	10.654.877	CC060823C3G	23	2	3
C3	0.016	10.654.888	CC061623C3G	23	2	1
C3	0.031	11.654.898	CC063123C3G	23	2	1
TAN18/C3	0.016	11.654.845	CC061623C3TAN18	23	2	2

Without Chip Breakers

Si3N4	0.016	11.654.841	CC061600Si3N4	0	3	1, 6
-------	-------	-------------------	---------------	---	---	------

PCD & CBN

PCD	0.008	11.938.847	CC060800PCD	0	4	3, 5
PCD	0.016	11.938.842	CC061600PCD	0	4	1, 5
PCD-FB	0.008	11.938.823	CC060800PCD-FB	0	5	3, 5
PCD-FB	0.016	11.938.824	CC061600PCD-FB	0	5	1, 5
CBN-CH	0.016	11.938.835	CC061600CBN-CH	0	4	1

CC..09

Grade	Radius	Catalog Number	Designation	Rake Angle	Form	Application Code
-------	--------	----------------	-------------	------------	------	------------------

Chip Breakers Presssed

C2	0.016	11.654.957	CC091615C2P	15	1	4, 6
C2	0.031	11.654.958	CC093115C2P	15	1	4, 6
CT51	0.016	11.654.959	CC091615C8CTP51	15	1	2
CT51	0.031	11.654.960	CC093115C8CTP51	15	1	2
TN11	0.016	11.654.940	CC091615C7TNP11	15	1	1, 8
TN11	0.031	11.654.952	CC093115C7TNP11	15	1	1, 8
TN12	0.016	11.654.943	CC091615C5TNP12	15	1	4
TN12	0.031	11.654.953	CC093115C5TNP12	15	1	4
TAN17	0.016	11.654.968	CC091615C2TAN17	15	1	6
TAN17	0.031	11.654.969	CC093115C2TAN17	15	1	6
RB10	0.031	11.654.964	CC093115C2RBP10	15	1	4, 7

Chip Breakers Ground

C3	0.016	10.654.977	CC091623C3G	23	2	1
C3	0.031	10.654.987	CC093123C3G	23	2	1
TAN18/C3	0.031	11.654.974	CC093123C3TAN18	23	2	2

Form 1

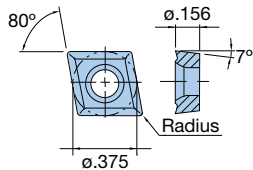

Form 2



Form 3

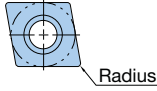

Form 4

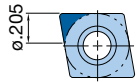

CC..09 Cont.

Grade	Radius	Catalog Number	Designation	Rake Angle	Form	Application Code
-------	--------	----------------	-------------	------------	------	------------------

Without Chip Breakers

Si3N4	0.031	11.654.951	CC093100Si3N4	0	3	1, 6
-------	-------	-------------------	---------------	---	---	------

PCD & CBN

PCD	0.016	11.938.843	CC091600PCD	0	4	1, 5
PCD	0.031	11.938.851	CC093100PCD	0	4	1, 5
CBN-CH	0.016	11.938.838	CC091600CBN-CH	0	4	1

Form 1

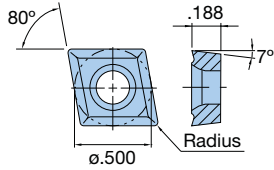

Form 2



Form 3



Form 4

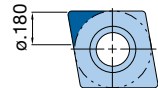

CC..12

Grade	Radius	Catalog Number	Designation	Rake Angle	Form	Application Code
-------	--------	----------------	-------------	------------	------	------------------

Chip Breakers Presssed

C2	0.016	11.654.989	CC121615C2P	15	1	4, 6
C2	0.031	11.654.991	CC123115C2P	15	1	4, 6
CT52	0.031	11.654.984	CC123115C7CTP52	15	1	1, 8
TN11	0.016	11.654.993	CC121615C7TNP11	15	1	1, 8
TN11	0.031	11.654.990	CC123115C7TNP11	15	1	1, 8
TN12	0.031	11.654.983	CC123115C5TNP12	15	1	4
TAN17	0.031	11.654.978	CC123115C2TAN17	15	1	6
RB10	0.031	11.654.965	CC123115C2RBP10	15	1	4, 7

Chip Breakers Ground

C3	0.016	10.654.995	CC123123C3G	23	2	1
C3	0.031	10.654.992	CC123123C3G	23	2	1
TAN18/C3	0.031	11.654.979	CC123123C3TAN18	23	2	2

Without Chip Breakers

Si3N4	0.031	10.654.980	CC123100Si3N4	0	3	1, 6
-------	-------	-------------------	---------------	---	---	------

PCD & CBN

PCD	0.031	10.938.871	CC123100PCD	0	4	2
CBN	0.031	10.938.862	CC123100CBN	0	4	1, 6

Form 1

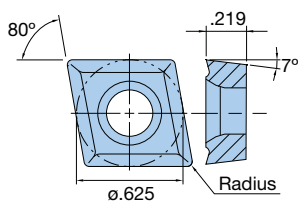

Form 2

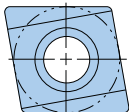

CC..16

Grade	Radius	Catalog Number	Designation	Rake Angle	Form	Application Code
-------	--------	----------------	-------------	------------	------	------------------

Chip Breakers Presssed

C3	0.031	10.654.997	CC163115C3P	15	1	4, 6
C6	0.031	10.654.999	CC163115C6P	15	1	3, 9
TN11	0.031	11.654.996	CC163115C7TNP11	15	1	1, 8
TN14	0.031	10.654.996	CC163115C6TNP14	15	1	1, 9
TN16	0.031	11.656.370	CC163115C6TNP16	15	1	4

Chip Breakers Ground

C3	0.031	10.654.998	CC163123C3G	23	2	1
----	-------	-------------------	-------------	----	---	---

Application Codes

1. Normal working conditions, rigid tool combination, workpiece well clamped
2. High production boring at high speed under favorable conditions
3. Unfavorable conditions, long tools, unstable workpiece or fixtures
4. Boring with interrupted cutting, impact loading
5. Boring or drilling of non-ferrous materials
6. Boring cast iron, nickel based, or high temp. alloys
7. Boring of hardened steel alloys (min. Rc50)
8. Boring of structural and alloyed steels
9. Boring of stainless steels and long chipping materials
10. High speed boring

ROUGH BORING INSERTS

TYPE SP..06, SP..08, SC..09 & SC..12

Form 1

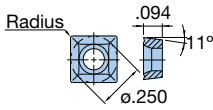

Form 2



SP..06

Grade	Radius	Catalog Number	Designation	Rake Angle	Form	Application Code
-------	--------	----------------	-------------	------------	------	------------------

Chip Breakers Pressed

TN11	.008	10.654.140	SP060815C7TNP11	15	1	3, 8
TN11	.016	10.654.150	SP061615C7TNP11	15	1	1, 8
TN16	.016	10.654.152	SP061615C2TNP16	15	1	4
C2	.016	10.654.158	SP061615C2P	15	1	4, 6

Chip Breakers Ground

C3	.016	10.654.168	SP061623C3G	23	2	1
----	------	-------------------	-------------	----	---	---

Form 1

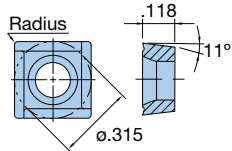

Form 2



SP..08

Grade	Radius	Catalog Number	Designation	Rake Angle	Form	Application Code
-------	--------	----------------	-------------	------------	------	------------------

Chip Breakers Pressed

C3	.020	10.654.187	SP082023C3G	23	1	1
C6	.020	10.654.183	SP082010C6G	10	1	1, 8

Chip Breakers Ground

C2	.020	10.654.128	SP082005C2G	0	2	1
----	------	-------------------	-------------	---	---	---

Form 1

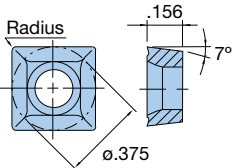

Form 2



SC..09

Grade	Radius	Catalog Number	Designation	Rake Angle	Form	Application Code
-------	--------	----------------	-------------	------------	------	------------------

Chip Breakers Pressed

C2	.016	11.654.249	SC091615C2P	15	1	4, 6
C2	.031	11.654.259	SC093115C2P	15	1	4, 6
TN11	.016	11.654.240	SC091615C7TNP11	15	1	1, 8
TN11	.031	11.654.250	SC093115C7TNP11	15	1	4
TN12	.016	11.654.247	SC091615C5TNP12	15	1	4
TN12	.031	11.654.200	SC093115C5TNP12	15	1	4
TN14	.031	11.654.252	SC093115C2TNP14	15	1	4, 6

Chip Breakers Ground

C3	.016	10.654.277	SC091623C3G	23	2	3
C3	.031	10.654.287	SC093123C3G	23	2	1

Form 1

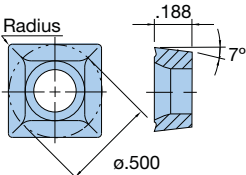

Form 2

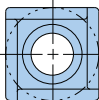

SC..12

Grade	Radius	Catalog Number	Designation	Rake Angle	Form	Application Code
-------	--------	----------------	-------------	------------	------	------------------

Chip Breakers Pressed

C2	.031	11.654.359	SC123115C2P	15	1	4, 6
TN11	.016	11.654.340	SC121615C7TNP11	15	1	1, 8
TN11	.031	11.654.350	SC123115C7TNP11	15	1	1, 8
TN11	.047	11.654.360	SC124715C7TNP11	15	1	4
TN12	.031	11.654.353	SC123115C5TNP12	15	1	4
RB10	.031	11.654.365	SC123115C2RBP10	15	1	4, 7

Chip Breakers Ground

C3	.031	10.654.387	SC123123C3G	23	2	1
----	------	-------------------	-------------	----	---	---

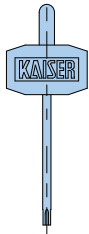
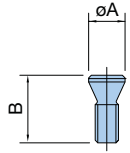

Insert Style & Size	Insert Screw*	Thread Size	A	B	Torx Wrench	Torx Size	Screws Per Package
TPGT07	10.694.103	M2.0	.106	.189	10.694.806	T6 IP	10
TCMT11	10.694.122	M2.5	.138	.256	10.694.807	T7 IP	10
CCMT06	10.694.122	M2.5	.138	.256	10.694.807	T7 IP	10
CCMT09	10.694.141	M4.0	.200	.362	10.694.815	T15 IP	10
CCMT12	10.694.150	M5.0	.276	.512	10.694.820	T20 IP	10
CCMT16	10.694.150	M5.0	.276	.512	10.694.820	T20 IP	10
SPGT08	10.694.121	M2.5	.169	.216	10.694.807	T7 IP	10
SCMT09	10.694.141	M4.0	.200	.362	10.694.815	T15 IP	10
SCMT12**	10.694.150	M4.0	.251	.591	10.694.820	T20 IP	10
WCMT02	10.694.101	M2.0	.106	.142	10.694.806	T6 IP	10
WCMT03	10.694.110	M2.2	.138	.236	10.694.807	T7 IP	10
WCMT04	10.694.124	M2.5	.138	.248	10.694.807	T7 IP	10
WCMT05	10.694.131	M3.0	.173	.323	10.694.809	T9 IP	10
WCMT06	10.694.137	M3.5	.189	.362	10.694.810	T10 IP	10
WCMT08	10.336.905	M4.0	.224	.323	10.694.815	T15 IP	10
WCMT10	10.694.150	M5.0	.276	.512	10.694.820	T20 IP	10

*One wrench supplied per package of insert screws

**Refer to insert holder section

T-Handle Hex-Allen Wrenches

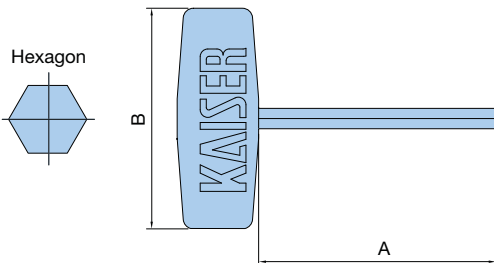

Catalog Number	Hex Size	A	B
10.690.819	1.5mm	2.000	1.770
10.690.811	2mm	2.000	1.770
10.690.812	2.5mm	2.000	1.770
10.690.813	3mm	2.000	1.770
10.690.814	4mm	2.000	1.770
10.690.816	5mm	2.750	2.560
10.690.817	6mm	2.750	2.560

Hex-Allen Wrenches

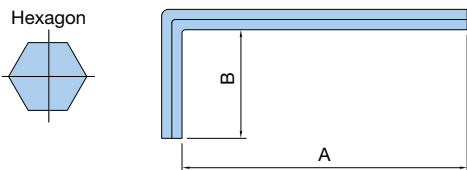

Catalog Number	Hex Size	A	B
10.690.833	1.3mm	1.650	.550
10.690.800	1.5mm	2.000	.550
10.690.801	2mm	2.000	.620
10.690.802	2.5mm	2.200	.710
10.690.803	3mm	2.500	.780
10.690.804	4mm	2.800	1.000
10.690.805	5mm	3.100	1.100
10.690.806	6mm	3.500	1.200
10.690.807	8mm	4.000	1.400
10.690.810	10mm	4.400	1.570
10.690.808	10mm	7.800	1.570
10.690.809	12mm	4.900	1.800

TOOL PRESETTERS



ALSO AVAILABLE IN CNC VERSION

The MAGIS is a new line of tool presetting and measuring systems & controls which revolutionizes the way one uses software in tool measuring. In today's world, software companies add screens, windows and menus in order to give the user more features. The Speroni MAGIS control for tool presetting and measuring combines all of the needed features and functions in a user friendly, clean and trouble free single screen user interface.

Specifications	MAGIS 400	MAGIS 500	MAGIS 600
Z Axis	400mm/15.75"	500mm/19.69"	600mm/23.62"
X Axis	400mm/15.75"	400mm/15.75"	400mm/15.75"
Max ϕ	350mm/13.78"	350mm/13.78"	350mm/13.78"
Axis Resolution	1 μ	1 μ	1 μ
T.I.R. @ 300mm	<5 μ	<5 μ	<5 μ
Spindle Concentricity	1 μ	1 μ	1 μ
Axis Positioning Repeatability (+/-)	2 μ	2 μ	2 μ



Ergonomically designed fine adjustment hand wheels allow for micron precise smooth adjustments of both X (diameter) and Z (height) axis throughout the system's range of travel.



The integrated high precision vertical rotating spindle is designed according to Speroni's world famous standards of robustness, reliability and unmatched precision - 1 μ concentricity. A pneumatically activated spindle disk brake and an ergonomic hand wheel are included for optimum focusing and adjustment of the tool cutting edge.



Mounted directly on the system's structure, micron precise Heidenhain[®] glass scales, state of the art Schneebberger[®] guideways, together with the largest and toughest recirculating ball bearing contact surface in its class, guarantee the highest precision and repeatability along the system's entire measuring range. Integrated cable carriers are present in both the X axis (base) and Z axis (column).



The FUTURA line of tool presetters represents over 50 years of experience in the manufacturing of high quality tool presetting and measuring equipment. As with all of Speroni's tool presetters, the structure is made completely of aged pearlitic cast iron in order to guarantee the best thermal stability. These tool presetting and measuring machines are the most rugged, dependable machines on the market. Designed for shop floor use, these machines provide tool presetting, tool inspection, and tool management along with unmatched repeatability and precision.

ALSO AVAILABLE IN CNC & AUTOSHRINK VERSIONS



Quick-change adapter system allows the changing of adapters in less than 8 seconds, guaranteeing unmatched precision and accuracy.

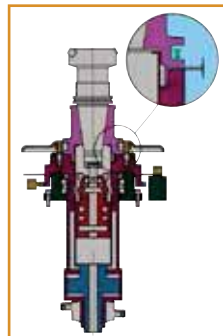

The uniquely designed "simultaneous fit" adapter clamping system allows for an adapter mount repeatability of .00016" (.004mm).



Optional dual monitors and 17" industrial grade touch screen monitor can be integrated with the keyboard and mouse operation for increased flexibility and ease of use.



TOOL PRO

A Safer Tool-Assembly Device

The Tool Pro is a unique tool holding device for the assembly and disassembly of tapered V-flange tooling and modular tooling systems. The head can be rotated 360° and locked in 45° increments, allowing convenient access for all operations in one setup.

Step Taper

Size	Catalog Number
30	31.300.001
35	31.300.000
40	31.300.002
45	31.300.003
50	31.300.004
60	31.300.020

HSK Taper

Size	Catalog Number
32A	31.300.017
40A	31.300.015
50A	31.300.008
63A	31.300.006
100A	31.300.005
125A	31.300.029

• HSK Type E/F, VDI and Polygon Taper also available

Chip and Coolant Fans – FAST...SAFE...AUTOMATIC – In-Process Cleaning Without Stopping Production!

For blowing and rinsing of workpieces and work surfaces quickly and efficiently.

Shank ϕ	Catalog Number	Description	Blade ϕ	Length	Speed (RPM)	
					Min	Max
20mm	24.303.202	Chip Fan 20mm x 160mm	160mm	82mm	6,000	12,000
	24.303.203	Chip Fan 20mm x 260mm	260mm	130mm	5,000	8,000
	24.303.201	Chip Fan 20mm x 330mm	330mm	166mm	5,000	8,000
.750	24.313.202	Chip Fan 3/4 x 160mm	6.3	3.228	6,000	12,000
	24.313.203	Chip Fan 3/4 x 260mm	10.2	5.118	5,000	8,000
	24.313.201	Chip Fan 3/4 x 330mm	13.0	6.535	5,000	8,000
Repair Kits	24.303.206	Chip Fan Repair Kit 160	6.3 (160mm)	—	—	—
	24.303.207	Chip Fan Repair Kit 260	10.2 (260mm)	—	—	—
	24.303.205	Chip Fan Repair Kit 330	13.0 (330mm)	—	—	—
Springs	24.303.210	Replacement Springs (10/pack)	—	—	—	—



As the machine spindle turns, the blades deploy to provide high volume air cleaning power!

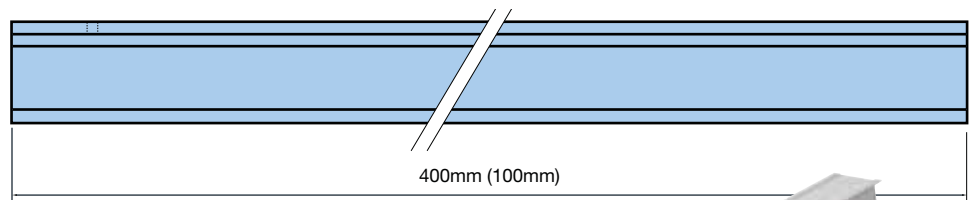
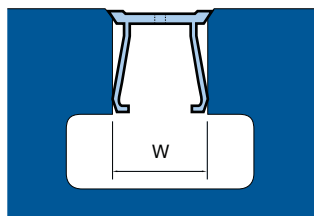

T-SLOT CLEAN PAT.P

Type	Catalog Number	Width W	Contents
Metric	TS14-S	14mm	400mm x 4 pieces 100mm x 4 pieces
	TS18-S	18mm	
	TS22-S	22mm	

Keep T-Slots Free From Chips!



• Cost saving sets, long sets and extra long sets also available

WEIGHTS

Catalog Number	Page	Weight
10.112.107	55	3.01
10.112.108	55	2.42
10.112.109B	54	2.88
10.112.117	55	3.01
10.112.118	55	2.42
10.112.119B	54	2.88
10.112.122	55	4.16
10.112.123	55	3.76
10.112.125	54	4.40
10.112.132	55	4.40
10.112.133	55	3.74
10.112.134	55	3.96
10.112.205	62	.57
10.112.206	62	.58
10.112.215	62	.57
10.112.216	62	.58
10.112.271	62	.06
10.112.272	62	.08
10.112.301A	64	1.19
10.112.304A	64	1.19
10.112.306	64	1.47
10.112.309	64	1.47
10.112.313	64	1.19
10.112.315	64	1.47
10.112.317	64	1.19
10.112.319	64	1.47
10.112.353	64	.11
10.112.385	64	.21
10.112.503	67	.07
10.112.505	67	.29
10.112.513	67	.57
10.112.515	67	.28
10.112.806	58	.35
10.112.817	69	1.98
10.112.819	69	1.98
11.112.911	61	5.27
11.112.912	61	6.59
11.112.913	61	6.81
11.112.914	61	7.31
11.112.919	61	6.25
11.112.937	61	10.56
10.310.905	54	.05
31.300.001	137	17.45
31.300.002	137	17.95
31.300.003	137	19.65
31.300.004	137	22.50

Catalog Number	Page	Weight
31.300.005	137	26.45
31.300.006	137	24.40
31.300.008	137	22.20
31.300.015	137	19.80
31.300.017	137	18.90
31.300.020	137	31.00
24.303.201	137	.70
24.303.202	137	.55
24.303.203	137	.65
24.303.205	137	.20
24.303.206	137	.10
24.303.207	137	.15
10.309.201	76	.26
10.309.211	76	.26
10.309.301	76	.48
10.309.311	76	.48
10.309.401	76	.88
10.309.411	76	.88
10.309.501	76	1.87
10.309.511	76	1.87
10.309.601	76	3.96
10.309.611	76	3.96
10.310.020	84	.07
10.310.021	84	.07
10.310.030	84	.11
10.310.031	84	.11
10.310.101	78	.17
10.310.111	78	.17
10.310.201	78	.29
10.310.211	78	.29
10.310.301	78	.46
10.310.305A	82	.48
10.310.311	78	.46
10.310.315A	82	.48
10.310.401	78	.88
10.310.403	77	.88
10.310.405A	82	.90
10.310.411	78	.88
10.310.413	77	.88
10.310.415A	82	.90
10.310.501	78	1.82
10.310.503	77	1.82
10.310.505A	82	1.78
10.310.511	78	1.82
10.310.513	77	1.82
10.310.515A	82	1.78

Catalog Number	Page	Weight
10.310.601	78	3.63
10.310.602	78	5.28
10.310.603	77	3.63
10.310.604	77	5.28
10.310.605A	82	3.74
10.310.606A	82	3.85
10.310.607	82	2.97
10.310.608	82	3.89
10.310.611	78	3.63
10.310.612	78	5.28
10.310.613	77	3.63
10.310.614	77	5.28
10.310.615A	82	3.74
10.310.616A	82	3.85
10.310.617	82	3.74
10.310.618	82	3.74
10.310.701	78	8.47
10.310.703	77	8.47
10.310.705	82	3.74
10.310.706	82	4.97
10.310.708	78	11.79
10.310.711	78	8.47
10.310.713	77	8.47
10.310.715	82	3.74
10.310.716	82	4.97
10.310.718	78	11.79
24.313.201	137	.70
24.313.202	137	.55
24.313.203	137	.65
10.315.101	45	.11
10.315.160	45	.01
10.315.201	45	.22
10.315.250	45	.01
10.315.301	45	.36
10.315.350	45	.02
10.315.401	45	.75
10.315.450	45	.04
10.315.501	45	1.40
10.315.550	45	.07
10.315.601	45	2.84
10.315.602	45	4.07
10.315.603	45	5.54
10.315.650	45	.08
10.315.701	45	6.82
10.315.702	45	9.90
10.315.703	45	12.32

Catalog Number	Page	Weight
10.315.750	45	.13
10.317.102A	100	3.96
10.317.105	100	4.16
10.317.112A	100	3.96
10.317.115	100	4.16
10.317.193	101	.002
10.317.202	98	6.05
10.317.205	98	.20
10.317.206	98	6.05
10.317.222	98	7.59
10.317.223	98	10.78
10.317.224	98	13.64
10.317.225	98	16.94
10.317.226	98	20.02
10.317.227	98	23.32
10.317.274	101	.002
10.317.285	108	1.86
10.317.287	99	.03
10.317.289	99	4.84
10.317.291	99	4.84
10.318.101	93	1.80
10.318.103	93	1.76
10.318.105	93	1.85
10.318.107	93	1.78
10.318.111	93	1.80
10.318.113	93	1.76
10.318.115	93	1.85
10.318.201N	90	5.50
10.318.202N	90	6.01
10.318.205N	90	4.03
10.318.206N	90	5.10
10.318.222	90	3.19
10.318.223	90	4.49
10.318.224	90	5.76
10.318.225	90	7.06
10.318.226	90	8.36
10.318.227	90	9.68
10.318.240	91	1.08
10.318.250	91	1.08
10.318.261	108	2.66
10.318.421	97	34.30
10.318.422	97	49.30
10.318.423	97	72.60
10.318.424	97	148.70
10.318.425	97	251.20
10.318.431	97	4.84

Catalog Number	Page	Weight
10.318.432	97	6.60
10.318.433	97	9.02
10.318.434	97	11.20
10.318.435	97	20.90
10.318.441	97	2.86
10.318.442	97	3.30
10.318.443	97	3.52
10.318.444	97	7.48
10.319.101	40	.12
10.319.150	41	.002
10.319.201	40	.24
10.319.250	41	.003
10.319.301	40	.42
10.319.350	41	.006
10.319.401	40	.79
10.319.450	41	.01
10.319.501	40	1.45
10.319.550	41	.01
10.319.601	40	2.60
10.319.601N	40	2.60
10.319.602	40	4.18
10.319.602N	40	4.18
10.319.603	40	5.02
10.319.603N	40	5.02
10.319.604N	41	1.14
10.319.605N	41	1.98
10.319.607N	41	2.42
10.319.650	41	.02
10.319.701	40	6.34
10.319.701N	40	6.34
10.319.701	40	9.06
10.319.702N	40	9.06
10.319.703	40	11.33
10.319.703N	40	11.33
10.319.705N	41	2.86
10.319.706N	41	3.42
10.319.707N	41	4.62
10.319.750	41	.07
11.321.562	14	3.00
11.321.952	14	7.00
11.321.962	14	7.00
11.321.974	14	8.50
10.322.563	15	4.00
10.323.735N	22	2.20
10.323.736N	22	2.86
10.323.775N	22	8.58

Catalog Number	Page	Weight
10.323.776N	22	10.45
10.323.831N	22	2.86
10.323.832N	22	2.20
10.323.871N	22	10.78
10.323.874N	22	8.58
10.324.131	13	.58
10.324.132	13	.56
10.324.141	13	.80
10.324.142	13	.75
10.324.231	13	1.02
10.324.241	13	1.14
10.324.251	13	1.56
10.324.331	12	1.87
10.324.332	12	2.46
10.324.341	12	2.53
10.324.342	12	2.87
10.324.352	12	2.11
10.324.353	12	2.90
10.324.361	12	2.75
10.324.361N	22	2.75
10.324.362	12	4.00
10.324.365	13	2.75
10.324.367N	22	7.04
10.324.461	12	4.29
10.324.551	12	6.39
10.324.561	13	6.38
10.324.561N	22	6.16
10.324.563	13	7.59
10.324.563N	22	7.37
10.324.566N	22	13.20
10.324.571	13	8.91
10.324.571N	22	9.02
10.324.572	13	12.76
10.324.572N	22	12.65
10.324.575N	22	26.25
10.324.904	10	.08
10.326.141	10	3.00
10.326.151	10	3.00
10.326.161	10	2.50
10.326.352	11	9.50
10.326.362	11	9.20
10.326.374	11	11.70
11.326.410	7	2.20
11.326.411	7	2.50
11.326.420	7	2.30
11.326.421	7	2.50



WEIGHTS

Catalog Number	Page	Weight
11.326.422	7	3.00
11.326.430	7	2.50
11.326.431	7	3.00
11.326.433	7	3.50
11.326.440	7	2.50
11.326.441	7	3.00
11.326.444	7	5.00
11.326.451	7	3.00
11.326.454	7	6.00
11.326.462	7	3.00
11.326.462N	22	3.00
11.326.464	7	6.50
11.326.464N	22	6.50
11.326.542	7	4.50
11.326.552	7	5.00
11.326.562	7	5.00
11.326.574	7	7.80
11.326.610	8	6.20
11.326.611	8	7.00
11.326.620	8	6.50
11.326.622	8	7.50
11.326.623	8	7.60
11.326.630	8	7.00
11.326.632	8	7.50
11.326.633	8	7.80
11.326.634	8	8.00
11.326.642	8	8.00
11.326.644	8	8.30
11.326.645	8	8.80
11.326.646	20	10.90
11.326.652	8	7.50
11.326.654	8	9.20
11.326.655	8	11.00
11.326.656	8	12.80
11.326.657	20	19.00
11.326.662	8	7.60
11.326.662N	22	7.60
11.326.664	8	10.50
11.326.664N	22	10.50
11.326.665	8	13.00
11.326.665N	22	13.00
11.326.666	8	15.80
11.326.666N	22	15.80
11.326.667	8	18.50
11.326.667N	22	18.50
11.326.668	20	25.50

Catalog Number	Page	Weight
11.326.674	8	9.80
11.326.674N	22	9.80
11.326.675	8	15.70
11.326.675N	22	15.70
11.326.676	8	21.00
11.326.676N	22	21.00
11.326.776	9	41.50
11.326.841	9	2.90
11.326.851	9	2.90
11.326.862	9	2.90
11.326.962	9	7.60
11.326.974	9	9.80
10.328.086	11	8.14
10.328.213	96	17.16
10.328.214	96	14.52
10.328.216	96	5.28
10.328.217N	96	9.68
10.329.866	10	.90
10.331.110	17	.11
10.331.111	17	.15
11.331.220	17	.22
11.331.221	17	.33
11.331.330	17	.35
11.331.331	17	.35
11.331.440	17	.77
11.331.441	17	1.00
11.331.550	17	1.90
11.331.551	17	2.70
11.331.660	17	3.00
11.331.661	17	4.40
11.331.770	17	9.70
11.331.771	17	16.00
10.331.860N	23	1.10
10.331.861N	23	1.76
10.331.864N	23	.99
10.331.865N	23	2.09
10.331.867N	23	1.14
10.331.868N	23	1.80
10.331.870N	23	3.10
10.331.871N	23	4.84
10.331.874N	23	2.09
10.331.875N	23	4.40
10.331.876N	23	6.82
10.331.877N	23	3.37
10.331.878N	23	6.60
10.331.879N	23	4.95

Catalog Number	Page	Weight
10.332.210	16	.20
10.332.310	16	.33
10.332.320	16	.35
10.332.410	16	.51
10.332.420	16	.55
10.332.430	16	.66
10.332.510	16	.97
10.332.511	16	.97
11.332.520	16	1.20
11.332.521	16	.92
10.332.530	16	1.50
10.332.531	16	.97
11.332.540	16	1.60
11.332.541	16	1.20
11.332.610	16	2.00
10.332.611	16	1.70
11.332.620	16	1.80
11.332.621	16	1.50
11.332.630	16	2.10
11.332.631	16	1.70
11.332.632	16	2.60
11.332.640	16	2.30
11.332.641	16	1.80
11.332.642	16	3.20
11.332.650	16	2.70
11.332.651	16	1.90
11.332.652	16	4.30
10.332.741	16	3.30
10.332.750	16	5.30
10.332.751	16	3.60
11.332.760	16	6.60
11.332.761	16	5.20
10.332.870N	23	2.44
11.335.002	121	1.30
11.335.004	121	1.40
10.335.066	120	4.36
11.335.067	120	4.65
10.335.077	120	10.45
11.335.078	120	9.15
11.335.106	119	2.10
11.335.107	119	2.95
11.335.108	119	5.75
11.335.113	119	4.20
11.335.114	119	6.70
11.335.115	119	9.60
11.335.185	119	.35

Catalog Number	Page	Weight
11.335.186	119	.75
11.335.187	119	1.75
11.335.188	119	2.30
11.335.201	118	1.45
11.335.202	118	1.35
11.335.203	118	1.50
11.335.204	118	1.65
11.335.205	118	2.25
11.335.206	118	2.55
11.335.207	118	2.75
11.335.208	118	3.10
11.335.209	118	4.40
11.335.216	118	5.40
11.335.217	118	5.30
11.335.218	118	12.25
11.335.220	118	.65
11.335.221	118	.55
11.335.222	118	.80
11.335.223	118	.80
11.335.226	118	.90
11.335.227	118	.95
11.335.228	118	1.15
11.335.229	118	1.10
10.335.230	118	.62
11.335.231	118	2.00
10.335.231	118	.66
10.335.232	118	.86
10.335.233	118	1.21
10.335.234	118	.90
10.335.235	118	.94
10.335.236	118	1.18
10.335.237	118	1.47
10.335.238	118	1.52
10.335.239	118	1.74
10.335.240	118	1.34
10.335.241	118	1.39
10.335.242	118	1.52
10.335.243	118	1.80
10.335.244	118	1.85
10.335.245	118	1.98
10.335.246	118	2.02
10.335.247	118	2.31
10.335.248	118	3.65
10.335.250	118	6.38
10.335.251	118	7.48
10.335.320	19	1.03

Catalog Number	Page	Weight
10.335.321	19	1.63
10.335.322	19	2.09
10.335.323	19	1.89
10.335.324	19	2.42
10.335.325	19	3.85
10.335.326	19	3.98
10.335.327	19	8.03
10.335.331	19	5.50
10.335.362	121	1.54
10.335.363	121	1.54
10.335.373	121	2.75
10.335.374	121	3.19
10.335.375	121	7.70
10.335.380	19	1.25
10.335.381	19	1.78
10.335.382	19	2.21
10.335.383	19	1.54
10.335.384	19	2.13
10.335.385	19	2.86
10.335.386	19	2.31
10.335.387	19	3.37
10.335.388	19	4.51
11.335.401	119	1.85
11.335.402	119	1.75
11.335.403	119	2.00
11.335.404	119	2.90
11.335.405	119	5.75
11.335.413	119	3.95
11.335.414	119	4.30
11.335.415	119	5.25
11.335.416	119	7.65
10.335.420	127	.58
10.335.423	127	.92
10.335.425	127	1.41
10.335.430	127	1.54
10.335.432	127	2.05
11.335.445	119	.60
11.335.446	119	.75
11.335.454	119	1.00
11.335.455	119	1.15
11.335.456	119	1.45
11.335.531	115	1.00
11.335.532	115	1.30
11.335.541	115	1.30
11.335.542	115	2.10
11.335.551	115	3.75

Catalog Number	Page	Weight
11.335.552	115	4.15
11.335.553	115	11.95
11.335.562	115	8.85
11.335.563	115	13.50
11.335.564	115	28.35
11.335.565	115	15.05
11.335.571	115	21.25
11.335.572	115	50.60
10.335.630	125	.12
10.335.631	125	.12
10.335.632	125	.11
10.335.633	125	.11
10.335.634	125	.11
10.335.635	125	.12
10.335.636	125	.12
10.335.637	125	.11
10.335.638	125	.12
10.335.639	125	.12
10.335.641	125	.11
10.335.642	125	.11
10.335.645	125	.56
10.335.646	125	.55
10.335.647	125	.54
10.335.648	125	.53
10.335.649	125	.54
10.335.650	125	.48
10.335.651	125	.46
10.335.652	125	.46
10.335.653	125	.44
10.335.654	125	.42
10.335.656	125	.40
10.335.657	125	.40
10.335.658	125	.38
10.335.660	125	.44
10.335.661	125	.44
10.335.662	125	.33
10.335.663	125	.33
10.335.664	125	.33
10.335.665	125	.33
10.335.666	125	.33
10.335.667	125	.33
10.335.668	125	.33
10.335.669	125	.33
10.335.671	125	.33
10.335.672	125	.33
10.335.675	125	1.30



WEIGHTS

Catalog Number	Page	Weight
10.335.676	125	1.10
10.335.677	125	1.28
10.335.678	125	1.11
10.335.679	125	1.10
10.335.680	125	1.05
10.335.681	125	1.05
10.335.682	125	1.05
10.335.683	125	1.05
10.335.684	125	1.01
10.335.686	125	1.01
10.335.687	125	1.01
10.335.688	125	1.00
11.335.760	124	.90
10.335.761	124	1.80
10.335.762	124	1.91
10.335.763	124	3.41
11.335.765	124	2.10
11.335.769	124	3.25
10.335.801	111	2.09
10.335.802	111	2.20
10.335.902	107	6.05
10.335.903	107	4.62
10.335.904	107	3.85
10.335.905	107	3.19
10.335.906	107	5.94
10.335.912	107	1.87
10.335.913	107	.88
10.335.915	107	.44
10.336.001	26	1.56
10.336.002	26	1.56
10.336.003	26	1.56
10.336.004	26	1.61
10.336.005	26	1.61
10.336.006	26	1.63
10.336.007	26	1.72
10.336.008	26	1.71
10.336.009	26	1.72
10.336.010	26	1.76
10.336.011	26	1.77
10.336.012	26	1.90
10.336.013	26	1.90
10.336.014	26	1.91
10.336.015	26	1.94
10.336.016	26	2.00
10.336.017	26	2.02
10.336.018	26	2.20

Catalog Number	Page	Weight
10.336.019	26	2.24
10.336.020	26	2.27
10.336.021	26	2.51
10.336.022	26	2.57
10.336.023	26	2.62
10.336.024	26	2.93
10.336.025	26	3.04
10.336.026	26	3.10
10.336.027	26	3.17
10.336.028	26	3.45
10.336.029	26	3.59
10.336.030	26	3.70
10.336.031	26	3.96
10.336.032	26	4.07
10.336.033	26	4.40
10.336.034	26	4.62
10.336.035	26	4.73
10.336.036	26	4.84
10.336.037	26	4.95
10.336.038	26	7.92
10.336.040	26	8.14
10.336.050	26	1.57
10.336.051	26	1.58
10.336.052	26	1.58
10.336.053	26	1.66
10.336.054	26	1.67
10.336.055	26	1.67
10.336.056	26	1.78
10.336.057	26	1.76
10.336.058	26	1.78
10.336.059	26	1.87
10.336.060	26	1.88
10.336.061	26	2.01
10.336.062	26	2.01
10.336.063	26	2.02
10.336.064	26	2.11
10.336.065	26	2.19
10.336.066	26	2.22
10.336.067	26	2.40
10.336.068	26	2.62
10.336.069	26	2.64
10.336.070	26	2.78
10.336.071	26	2.97
10.336.072	26	3.04
10.336.073	26	3.34
10.336.074	26	3.48

Catalog Number	Page	Weight
10.336.075	26	3.59
10.336.076	26	3.85
10.336.077	26	4.16
10.336.078	26	4.36
10.336.079	26	4.47
10.336.080	26	4.95
10.336.081	26	5.06
10.336.082	26	5.39
10.336.083	26	5.72
10.336.084	26	5.83
10.336.085	26	6.27
10.336.086	26	6.82
10.336.087	26	9.68
10.336.088	26	10.34
10.336.089	26	11.88
11.336.311	28	2.85
11.336.313	28	7.70
11.336.315	28	7.70
10.336.631	27	2.05
10.336.632	27	2.02
10.336.633	27	2.20
10.336.634	27	2.16
10.336.635	27	2.11
10.336.636	27	2.27
10.336.637	27	2.53
10.336.638	27	2.51
10.336.639	27	2.55
10.336.640	27	2.55
10.336.641	27	2.62
10.336.642	27	2.68
10.336.643	27	2.93
10.336.644	27	2.97
10.336.645	27	3.08
10.336.647	27	3.21
10.336.649	27	3.50
10.336.651	27	3.85
10.336.653	27	3.89
10.336.655	27	4.73
10.336.657	27	4.40
10.336.659	27	4.60
10.336.661	27	4.99
10.336.731	27	2.18
10.336.732	27	2.22
10.336.733	27	2.29
10.336.734	27	2.42
10.336.735	27	2.62

Catalog Number	Page	Weight
10.336.736	27	2.73
10.336.737	27	2.75
10.336.738	27	2.79
10.336.739	27	3.08
10.336.740	27	3.01
10.336.741	27	3.04
10.336.742	27	3.52
10.336.743	27	3.34
10.336.744	27	3.43
10.336.745	27	3.52
10.336.747	27	3.85
10.336.749	27	4.22
10.336.751	27	4.40
10.336.753	27	5.28
10.336.755	27	5.50
10.336.757	27	5.72
10.336.759	27	6.49
10.336.761	27	6.25
10.336.905	135	.04
10.337.316	27	1.65
10.337.317	27	1.65
10.337.318	27	1.67
10.337.319	27	1.68
10.337.320	27	1.73
10.337.321	27	1.73
10.337.322	27	1.75
10.337.323	27	1.80
10.337.324	27	1.85
10.337.325	27	1.88
10.337.326	27	1.95
10.337.327	27	2.02
10.337.328	27	2.06
10.337.329	27	2.11
10.337.330	27	2.18
10.337.416	27	1.65
10.337.417	27	1.65
10.337.418	27	1.72
10.337.419	27	1.74
10.337.420	27	1.76
10.337.421	27	1.77
10.337.422	27	1.83
10.337.423	27	1.88
10.337.424	27	1.93
10.337.425	27	1.99
10.337.426	27	2.11
10.337.427	27	2.19

Catalog Number	Page	Weight
10.337.428	27	2.24
10.337.429	27	2.32
10.337.430	27	2.41
11.340.602	36	1.80
11.340.604	37	1.80
11.340.612	36	1.90
11.340.614	37	1.90
11.340.624	37	1.95
11.340.632	36	2.00
11.340.634	37	2.40
11.340.642	36	2.25
11.340.644	37	2.60
11.340.646	37	2.70
11.340.652	36	2.70
11.340.654	37	3.20
11.340.656	37	3.70
11.340.664	37	4.00
11.340.665	37	4.55
11.340.674	37	7.35
11.341.025	36	.01
11.341.026	36	.01
11.341.027	36	.01
11.341.028	36	.01
11.341.029	36	.01
11.341.030	36	.01
11.341.101	36	.02
11.341.102	36	.02
11.341.103	36	.02
11.341.104	36	.02
11.341.105	36	.02
11.341.106	36	.02
11.341.107	36	.02
11.341.108	36	.03
11.341.125	36	.02
11.341.126	36	.02
11.341.127	36	.02
11.341.128	36	.02
11.341.129	36	.02
11.341.130	36	.02
11.341.131	36	.02
11.341.132	36	.02
11.341.202	36	.03
11.341.204	36	.03
11.341.206	36	.03
11.341.208	36	.03
11.341.210	36	.03

Catalog Number	Page	Weight
11.341.212	36	.04
11.341.214	36	.04
11.341.226	36	.03
11.341.228	36	.03
11.341.230	36	.03
11.341.232	36	.03
11.341.234	36	.03
11.341.236	36	.03
11.341.238	36	.04
11.341.302	36	.06
11.341.304	36	.06
11.341.306	36	.06
11.341.308	36	.07
11.341.310	36	.07
11.341.312	36	.07
11.341.314	36	.08
11.341.316	36	.08
11.341.326	36	.06
11.341.328	36	.08
11.341.330	36	.08
11.341.332	36	.08
11.341.334	36	.08
11.341.336	36	.08
11.341.338	36	.09
11.341.340	36	.09
11.341.404	36	.15
11.341.408	36	.16
11.341.412	36	.16
11.341.416	36	.16
11.341.420	36	.17
11.341.428	36	.15
11.341.432	36	.16
11.341.436	36	.16
11.341.440	36	.17
11.341.444	36	.17
11.341.901	36	.01
11.341.902	36	.01
11.341.903	36	.01
11.341.904	36	.02
11.341.905	36	.03
11.341.906	36	.03
11.360.556	9	28.00
11.360.562	9	23.50
11.360.564	9	26.00
11.360.565	9	28.00
11.360.567	9	33.00



WEIGHTS

Catalog Number	Page	Weight
11.360.575	9	30.50
11.360.576	9	35.50
11.360.578	9	45.00
11.361.052	15	2.00
11.361.162	15	3.50
11.361.262	15	4.00
11.361.462	15	5.00
11.361.474	15	11.00
11.362.261	15	2.40
11.366.774	15	9.40
11.368.441	7	3.00
11.368.444	7	5.00
11.368.451	7	3.00
11.368.454	7	6.00
11.368.462	7	3.00
11.368.462N	22	3.10
11.368.464	7	6.50
11.368.642	8	8.00
11.368.644	8	8.30
11.368.645	8	8.80
11.368.652	8	7.50
11.368.654	8	9.20
11.368.655	8	11.00
11.368.656	8	12.80
11.368.662	8	7.60
11.368.662N	22	7.80
11.368.664	8	10.50
11.368.664N	22	10.50
11.368.665	8	13.00
11.368.666	8	15.80
11.368.666N	22	15.80
11.368.667	8	18.50
11.368.667N	22	18.50
11.368.674	8	9.80
11.368.674N	22	10.00
11.368.675	8	15.70
11.368.675N	22	15.70
11.368.676	8	21.00
11.370.101	19	13.30
11.370.321	19	1.60
11.370.322	19	2.10
11.370.324	19	2.40
11.370.325	19	4.00
11.370.327	19	8.00
11.370.328	19	5.80
11.370.330	19	8.80

Catalog Number	Page	Weight
11.380.306	80	.04
11.380.321	80	.03
11.380.322	80	.03
11.380.323	80	.04
11.380.324	80	.06
11.380.325	80	.10
11.380.326	80	.03
11.380.327	80	.03
11.380.328	80	.04
11.380.329	80	.06
11.380.330	80	.10
11.380.341	80	.06
11.380.587	80	.10
11.381.223	117	.08
11.381.224	117	.08
11.381.243	117	.13
11.381.244	117	.11
11.381.316	117	.04
11.381.326	117	.08
11.381.346	117	.13
11.381.416	117	.06
11.381.426	117	.06
11.381.446	117	.10
11.382.223	116	.09
11.382.224	116	.09
11.382.244	116	.15
11.382.316	116	.05
11.382.326	116	.09
11.382.346	116	.13
11.382.356	116	.18
11.382.366	116	.12
10.456.001	115	.07
10.456.002	115	.07
10.456.003	115	.23
10.456.004	115	.37
10.456.005	115	.51
10.456.011	115	.07
10.456.012	115	.07
10.456.013	115	.23
10.456.014	115	.37
10.456.015	115	.51
10.470.108	55	4.27
10.470.118	55	4.27
10.470.301	78	.65
10.470.311	78	.65
10.470.401	78	1.29

Catalog Number	Page	Weight
10.470.411	78	1.29
10.470.501	78	2.48
10.470.511	78	2.48
10.470.601	78	4.82
10.470.602	78	6.36
10.470.611	78	4.82
10.470.612	78	6.36
10.611.155	57	.01
10.611.156	57	.01
10.613.202	62	.03
10.613.203	62	.02
10.613.204	62	.03
10.613.205	62	.02
10.613.206	62	.02
10.613.207	62	.02
10.613.208	62	.01
11.613.213	62	.03
11.613.214	62	.03
11.613.215	62	.03
11.613.216	62	.02
11.613.218	62	.02
10.613.304	66	.04
10.613.305	66	.04
10.613.307	64	.04
10.613.308	64	.03
10.613.309	64	.04
10.613.310	64	.02
11.613.313	66	.06
11.613.314	66	.06
11.613.315	66	.06
11.613.316	66	.05
11.613.318	66	.04
10.613.323	64	.14
10.613.324	64	.14
10.613.325	64	.13
10.613.326	64	.13
10.613.327	64	.13
10.613.404	56	.11
10.613.405	56	.11
10.613.406	56	.10
10.613.407	56	.10
10.613.408	56	.09
10.613.409	56	.09
10.613.410	56	.08
10.613.411	56	.06
10.613.412	56	.06

Catalog Number	Page	Weight
10.613.413	56	.04
10.613.414	56	.03
10.613.422	56	.28
10.613.423	56	.26
10.613.424	56	.29
10.613.425	56	.29
10.613.426	56	.26
10.613.427	56	.26
10.613.428	56	.33
10.613.429	56	.26
10.613.430	56	.29
10.613.504	56	.11
10.613.505	56	.11
10.613.506	56	.10
10.613.508	56	.09
10.613.509	56	.08
10.613.510	56	.07
10.613.511	56	.06
10.613.512	56	.06
10.613.513	56	.04
10.613.514	56	.03
10.613.522	56	.28
10.613.523	56	.26
10.613.524	56	.26
10.613.525	56	.28
10.613.526	56	.26
10.613.527	56	.26
10.613.528	56	.33
10.613.529	56	.30
10.613.530	56	.29
11.613.543	60	.11
11.613.544	60	.11
11.613.545	60	.11
11.613.546	60	.11
11.613.548	60	.09
11.613.550	60	.08
11.613.551	60	.07
11.613.552	60	.05
10.615.201	57	.04
10.615.202	57	.09
10.615.203	57	.02
10.615.204	57	.03
10.615.205	57	.04
10.615.206	57	.25
10.615.207	57	.10
10.615.208	57	.19

Catalog Number	Page	Weight
10.615.209	57	.35
10.615.210	57	.52
10.615.211	57	.04
10.615.212	57	.10
10.615.213	57	.28
10.615.214	57	.06
10.615.215	57	.15
10.615.216	63	.06
10.615.217	63	.09
10.615.218	57	.13
10.615.219	57	.31
10.615.220	60	.03
10.615.221	57	.66
10.615.223	57	.22
10.615.224	57	.44
10.615.225	57	.31
10.615.226	57	.28
10.615.227	57	.57
10.615.228	60	.08
10.615.229	57	.88
10.615.230	60	.07
10.615.231	60	.08
10.615.232	57	.20
10.615.233	57	.55
10.615.234	65	.14
10.615.236	57	.68
10.615.237	57	.55
10.615.238	57	.92
10.615.239	65	.37
10.615.240	65	.47
10.615.243	65	.30
10.615.250	57	.31
10.615.251	57	.55
10.615.252	59	.66
10.615.253	59	.99
10.615.254	59	.64
10.615.255	59	.97
10.615.256	66	.40
10.615.257	59	.81
10.615.258	59	1.14
10.615.259	59	.85
10.615.260	59	1.14
10.615.261	59	.31
10.615.262	59	.31
10.615.263	59	.53
10.615.264	59	.46

Catalog Number	Page	Weight
10.615.271	57	.02
10.615.272	57	.03
10.615.273	57	.03
10.615.280	57	.03
10.615.281	57	.04
10.615.282	57	.06
10.615.283	57	.07
10.615.284	57	.08
10.615.285	57	.09
10.615.286	57	.09
10.615.287	57	.11
10.615.288	57	.07
10.615.289	57	.07
10.615.290	57	.07
10.615.291	57	.07
10.615.292	57	.08
10.615.301	59	.03
10.615.302	59	.04
10.615.303	59	.04
10.615.304	59	.12
10.615.305	59	.13
10.615.306	59	.10
10.615.365	59	.01
10.615.366	59	.02
10.615.367	59	.03
10.615.369	59	.23
10.615.370	66	.26
10.615.371	59	.37
10.615.372	66	.44
10.615.373	59	.57
10.615.374	59	.15
10.615.376	59	.29
10.615.378	59	.48
10.615.387B	59	60
10.615.389	59	.60
10.615.390	106	.75
10.615.391	106	.75
10.615.392	59	.03
10.615.393	60	.11
10.615.394	60	.11
10.615.395	60	.11
10.615.501	67	.05
10.615.502	67	.05
10.615.503	67	.05
10.615.504	67	.05
10.615.505	67	.04



WEIGHTS

Catalog Number	Page	Weight
10.615.506	67	.05
10.615.507	67	.05
10.615.508	67	.05
10.615.509	67	.05
10.615.511	67	.07
10.615.522	67	.04
10.615.524	67	.04
10.615.525	67	.04
10.615.530	67	.04
10.615.531	67	.07
10.615.541	67	.07
10.615.542	67	.07
10.615.543	67	.07
10.615.544	67	.07
10.615.545	67	.07
10.615.546	67	.09
10.615.547	67	.09
10.615.903	107	.06
10.625.020	84	.02
10.626.111	79	.02
10.626.112	79	.02
10.626.113	79	.02
10.626.121	79	.02
10.626.122	79	.02
10.626.123	79	.02
10.626.131	79	.02
10.626.132	79	.02
10.626.133	79	.02
10.626.141	79	.03
10.626.142	79	.03
10.626.143	79	.04
10.626.151	79	.04
10.626.152	79	.06
10.626.153	79	.07
10.626.161	79	.10
10.626.162	79	.15
10.626.163	79	.18
10.626.231	83	.02
10.626.241	83	.03
10.626.251	83	.05
10.626.261	83	.08
10.626.271	93	.07
10.626.322	79	.02
10.626.323	79	.02
11.626.331	79	.03
10.626.332	79	.02

Catalog Number	Page	Weight
10.626.333	79	.03
11.626.341	79	.04
10.626.342	79	.03
10.626.343	79	.04
11.626.351	79	.06
10.626.352	79	.07
10.626.353	79	.08
11.626.361	79	.10
10.626.363	79	.20
10.626.364	79	.20
10.626.371	93	.07
10.626.907	59	.06
10.626.908	59	.12
10.626.909	59	.20
10.626.910	59	.24
10.627.121	76	.01
10.627.131	76	.02
10.627.141	76	.04
10.627.151	76	.09
10.627.161	76	.11
10.637.814	99	1.87
10.637.830	99	1.88
10.637.834	99	1.87
10.637.846	99	1.89
10.637.940	91	1.56
10.637.941	91	1.56
10.637.942	91	1.56
10.637.951	91	.79
10.637.953	91	.77
10.637.959	92	.79
10.638.104	47	.15
10.638.105	47	.28
10.638.106	47	.43
10.638.107	47	.69
10.638.108	47	.94
10.638.111	46	.03
10.638.121	46	.05
10.638.131	46	.12
10.638.132	46	.16
10.638.141	46	.22
10.638.142	46	.31
10.638.151	46	.42
10.638.152	46	.59
10.638.161	46	.75
10.638.162	46	1.03
10.638.171	46	1.28

Catalog Number	Page	Weight
10.638.172	46	1.83
10.638.241	46	.24
10.638.251	46	.44
10.638.252	46	.50
10.638.261	46	.77
10.638.262	46	.99
10.638.271	46	1.33
10.638.272	46	1.77
10.638.411	46	.03
10.638.412	46	.04
10.638.421	46	.05
10.638.422	46	.06
10.638.431	46	.11
10.638.432	46	.15
10.638.441	46	.21
10.638.442	46	.29
10.638.451	46	.39
10.638.452	46	.55
10.638.461	46	.72
10.638.462	46	.99
10.638.471	46	1.23
10.638.472	46	1.72
10.638.561	46	.70
10.638.562	46	.99
10.638.571	46	1.22
10.638.572	46	1.69
10.639.104	43	0.22
10.639.105	43	0.41
10.639.106	43	0.85
10.639.107	43	1.22
10.639.108	43	1.71
10.639.109	43	2.31
10.639.110	43	2.53
10.639.113	42	.04
10.639.123	42	.08
10.639.133	42	.13
10.639.137	42	.18
10.639.143	42	.20
10.639.147	42	.25
10.639.153	42	.40
10.639.157	42	.60
10.639.163	42	.95
10.639.167	42	1.18
10.639.173	42	1.80
10.639.177	42	2.40
10.639.183	42	2.60

Catalog Number	Page	Weight
10.639.187	42	3.10
10.639.403	44	.14
10.639.404	44	.20
10.639.405	44	.42
10.639.406	44	1.00
10.639.407	44	1.45
10.639.408	44	1.69
10.639.409	44	2.29
10.639.410	44	2.54
10.639.413	42	.04
10.639.417	42	.08
10.639.423	42	.20
10.639.427	42	.25
10.639.433	42	.14
10.639.437	42	.18
10.639.443	42	.20
10.639.447	42	.26
10.639.453	42	.40
10.639.457	42	.60
10.639.463	42	.95
10.639.467	42	1.18
10.639.473	42	1.80
10.639.477	42	2.40
10.639.483	42	2.60
10.639.487	42	3.10
10.639.563	42	.94
10.639.567	42	1.16
10.639.573	42	1.70
10.639.577	42	2.30
10.639.583	42	2.50
10.639.587	42	3.00
10.651.xxx	130	—
11.651.xxx	130	—
10.654.230	111	.01
10.654.231	111	.004
10.654.232	111	.004
10.654.xxx	132-134	—
11.654.xxx	132-134	—
10.655.670	30	.002
10.655.671	30	.04
10.655.800	111	.02
10.655.801	111	.02
10.655.802	111	.02
10.655.821	60	.002
10.655.822	60	.002
10.655.910	31	.004

Catalog Number	Page	Weight
10.655.911	31	.004
10.655.912	31	.004
10.655.913	31	.004
10.655.920	31	.004
10.655.921	31	.004
10.655.922	31	.004
10.655.923	31	.004
10.655.930	31	.01
10.655.931	31	.01
10.655.932	31	.01
10.655.933	31	.01
10.655.xxx	130-131	—
11.655.xxx	130-131	—
11.658.620	30	.04
11.658.624	30	.04
11.658.630	30	.05
11.658.634	30	.05
11.658.640	30	.08
11.658.644	30	.08
11.658.650	30	.11
11.658.654	30	.11
11.658.660	30	.23
11.658.664	30	.23
10.663.110	114	.10
10.663.120	114	.15
10.663.121	114	.31
10.663.130	114	.20
10.663.131	114	.40
10.663.140	114	.22
10.663.141	114	.46
10.663.150	114	1.10
10.663.151	114	2.09
10.663.160	114	1.41
10.663.161	114	2.75
10.663.181	114	.02
10.663.185	114	.09
10.663.191	114	.01
10.663.195	114	.07
11.689.801	60	.04
11.689.802	60	.04
11.689.803	60	.04
11.689.804	60	.06
11.689.805	60	.08
11.689.806	60	.08
11.689.807	60	.09
11.689.808	60	.12

Catalog Number	Page	Weight
11.689.809	60	.15
11.689.810	60	.03
11.689.811	60	.04
11.689.812	60	.05
11.689.813	60	.07
11.689.814	60	.08
11.689.815	60	.08
11.689.816	60	.08
11.689.817	60	.08
11.689.818	60	.09
11.689.819	60	.09
11.689.820	60	.09
11.689.821	60	.09
11.689.822	60	.10
11.689.823	60	.10
11.689.824	60	.11
11.689.903	47	.06
11.689.904	47	.12
11.689.905	47	.19
11.689.906	47	.23
11.689.907	47	.36
11.689.908	47	.43
11.689.909	47	.58
11.689.910	47	.75
10.690.101	41	.004
10.690.102	114	.01
10.690.103	114	.01
10.690.104	114	.01
10.690.105	41	.06
10.690.106	41	.07
10.690.108	41	.01
10.690.115	76	.01
10.690.121	101	.12
10.690.124	95	.07
10.690.126	5	.07
10.690.127	5	.12
10.690.128	5	.22
10.690.129	5	.21
10.690.130	5	.53
10.690.135	81	.002
10.690.136	81	.002
10.690.137	81	.01
10.690.138	81	.01
10.690.139	81	.004
10.690.140	83	.01
10.690.141	81	.02



WEIGHTS

Catalog Number	Page	Weight
10.690.145	41	.001
10.690.156	68, 76	.01
10.690.157	41	.006
10.690.163	41	.07
10.690.172	101	.10
10.690.173	41	.01
10.690.176	76	.01
10.690.177	76	.01
10.690.178	76	.01
10.690.179	76	.002
10.690.180	76	.01
10.690.182	76	.01
10.690.184	41	.001
10.690.186	41	.001
10.690.188	41	.003
10.690.189	41	.002
10.690.191	41	.001
10.690.192	41	.001
10.690.193	41	.001
10.690.194	41	.002
10.690.195	41	.003
10.690.196	41	.005
10.690.197	41	.01
10.690.994	54	.01
10.690.410	81	.002
10.690.414	84	.002
10.690.416	84	.002
10.690.418	68	.002
10.690.421	68	.002
10.690.426	41	.002
10.690.431	4	.002
10.690.432	4	.002
10.690.433	4	.004
10.690.434	4	.01
10.690.435	4	.01
10.690.436	4	.02
10.690.437	4	.11
10.690.440	68	.002
10.690.449	68	.004
10.690.452	68	.01
10.690.457	54	.01
10.690.459	68	.002
10.690.460	68	.004
10.690.469	54	.01
10.690.477	118	.004
10.690.478	118	.01

Catalog Number	Page	Weight
10.690.479	118	.01
10.690.480	118	.02
10.690.481	118	.04
10.690.482	118	.04
10.690.483	118	.08
10.690.484	118	.10
10.690.486	68	.002
10.690.487	68	.02
10.690.488	68	.02
10.690.489	68	.002
11.690.517	118	.002
11.690.518	118	.01
11.690.519	118	.01
11.690.520	118	.03
11.690.521	118	.03
11.690.522	118	.06
11.690.523	118	.08
10.690.529	41	.002
10.690.537	41	.002
10.690.538	68	.002
10.690.549	81	.002
10.690.550	76, 81	.002
10.690.551	81	.002
10.690.552	81	.01
10.690.553	81	.01
10.690.577	83	.002
10.690.578	83	.004
10.690.579	83	.01
10.690.580	83	.01
10.690.584	45	.004
10.690.585	45	.01
10.690.586	45	.01
10.690.587	45	.01
10.690.588	45	.01
10.690.591	76	.01
10.690.595	68	.01
10.690.596	101	.03
10.690.610	84	.002
10.690.654	5	.02
10.690.655	5	.07
10.690.656	5	.08
10.690.657	5	.18
10.690.658	76	.01
10.690.666	22	.01
10.690.667	22	.07
11.690.709	119	.04

Catalog Number	Page	Weight
11.690.710	119	.08
11.690.711	119	.15
11.690.712	119	.31
11.690.713	119	.51
11.690.714	119	.90
10.690.800	135	.002
10.690.801	135	.002
10.690.802	135	.002
10.690.803	135	.01
10.690.804	135	.02
10.690.805	135	.04
10.690.806	135	.07
10.690.807	135	.13
10.690.808	135	.35
10.690.809	135	.37
10.690.810	135	.22
10.690.811	135	.03
10.690.812	135	.03
10.690.813	135	.04
10.690.814	135	.04
10.690.816	135	.11
10.690.817	135	.10
10.690.819	45	.12
10.690.833	135	.002
10.690.843	135	.02
10.690.847	5	.28
10.690.848	5	.37
10.690.849	5	.48
10.690.850	5	.66
10.690.851	5	.24
10.690.852	5	.44
10.690.853	5	.72
10.690.854	5	1.50
10.690.855	5	.55
10.690.940	76	.002
10.690.943	76	.01
10.690.953	76	.01
10.690.970	41	.11
10.690.978	68	.002
10.691.373	101	.01
10.691.390	95	.02
10.691.501	4	.002
10.691.502	4	.004
10.691.503	4	.01
10.691.504	4	.02
10.691.505	4	.05

Catalog Number	Page	Weight
10.691.506	4	.11
10.691.507	4	.24
10.691.600	127	.002
10.691.602	127	.01
10.691.605	127	.03
10.691.607	127	.10
10.690.703	127	.04
10.690.705	127	.18
10.692.295	95	.001
10.692.296	54	.001
10.692.404A	68	.81
10.692.406	41	.01
10.692.409	41	.004
10.693.131	114	.002
10.693.175	41, 76	.002
10.693.176	41, 76	.002
10.693.177	41, 76	.002
10.693.178	41	.002
10.693.179	41	.002
10.693.180	45	.002
10.693.181	45	.01
10.693.182	45	.01
10.693.183	45	.04
10.693.184	45	.05
10.693.185	45	.01
10.693.186	76	.01
10.693.187	45	.01
10.693.289	76	.002
10.694.101	135	.01
10.694.103	135	.01
10.694.110	135	.01
10.694.121	135	.01
10.694.122	135	.01
10.694.124	135	.01
10.694.131	135	.01
10.694.137	135	.01
10.694.141	135	.01
10.694.144	135	.01
10.694.150	135	.01
10.694.806	135	.004
10.694.807	135	.01
10.694.809	135	.004
10.694.810	135	.004
10.694.815	135	.004
10.694.820	135	.004
10.696.901	54	.07

Catalog Number	Page	Weight
10.938.xxx	130-133	—
11.938.xxx	130-133	—
10.958.008	126	.10
10.958.010	126	.08
10.958.021	126	.18
10.958.031	126	.24
10.958.041	126	1.10
10.958.048	126	.02
10.958.049	126	.13
10.958.051	126	.004
10.958.052	126	.004
10.958.053	126	.004
10.958.055	126	.004
10.958.056	126	.004
10.958.057	126	.004
10.958.061	126	.004
10.958.062	126	.004
10.958.063	126	.004
10.958.065	126	.004
10.958.066	126	.004
10.958.067	126	.004
10.958.071	126	.004
10.958.072	126	.004
10.958.073	126	.004
10.958.075	126	.004
10.958.076	126	.004
10.958.077	126	.004
10.958.081	126	.004
10.958.082	126	.004
10.958.083	126	.004
10.958.085	126	.004
10.958.086	126	.004
10.958.087	126	.004
10.958.091	126	.02
10.958.092	126	.02
10.958.093	126	.02
10.958.095	126	.02
10.958.096	126	.02
10.958.097	126	.02
10.958.155	127	.03
10.958.156	127	.03
10.958.157	127	.004
10.958.158	127	.01
10.958.313	127	.004
10.958.314	127	.004
AC20-10	120	.22

Catalog Number	Page	Weight
AC20-12	120	.21
AC20-16	120	.15
AC20-6	120	.25
AC20-8	120	.23
AC32-10	120	.82
AC32-12	120	.78
AC32-16	120	.72
AC32-20	120	.68
AC32-25	120	.62
AC32-6	120	.90
AC32-8	120	.87
BBT30-CK1-105	10	1.12
BBT30-CK2-75	10	0.66
BBT30-CK2-120	10	1.25
BBT30-CK3-80	10	0.99
BBT30-CK3-120	10	1.47
BBT30-CK4-85	10	1.01
BBT30-CK4-120	10	1.67
BBT30-CK5-120	10	1.76
BBT30-CK6-135	10	2.86
BBT40-CK1-105	10	2.42
BBT40-CK2-80	10	2.20
BBT40-CK2-120	10	2.64
BBT40-CK3-85	10	2.42
BBT40-CK3-135	10	2.86
BBT40-CK3-165	10	3.30
BBT40-CK4-90	10	2.64
BBT40-CK4-135	10	3.30
BBT40-CK4-165	10	3.96
BBT40-CK4-195	10	4.62
BBT40-CK5-105	10	2.64
BBT40-CK5-135	10	3.52
BBT40-CK5-165	10	4.62
BBT40-CK5-195	10	5.50
BBT40-CK6-135	10	3.52
BBT40-CK6-165	10	5.06
BBT40-CK6-195	10	6.82
BBT40-HDC19-75	18	3.10
BBT40-HDC24-75	18	3.52
BBT40-HDC31-75	18	3.96
BBT40-OCK6N-149	24	11.90
BBT50-OCK6N-139	24	15.80
BBT50-CK1-135	11	8.80
BBT50-CK2-90	11	8.36
BBT50-CK2-150	11	8.80
BBT50-CK3-95	11	8.58



WEIGHTS

Catalog Number	Page	Weight
BBT50-CK3-165	11	9.46
BBT50-CK4-105	11	9.46
BBT50-CK4-165	11	9.90
BBT50-CK4-225	11	10.78
BBT50-CK4-255	11	11.22
BBT50-CK4DP-299	20	12.60
BBT50-CK5-120	11	8.80
BBT50-CK5-165	11	10.34
BBT50-CK5-240	11	12.98
BBT50-CK5-285	11	14.30
BBT50-CK5-320	11	15.40
BBT50-CK5DP-371	20	20.70
BBT50-CK6-165	11	10.56
BBT50-CK6-240	11	14.74
BBT50-CK6-300	11	18.04
BBT50-CK6-360	11	21.34
BBT50-CK6DP-451	20	26.70
BBT50-CK7-210	11	11.00
BBT50-CK7-300	11	20.68
BBT50-CK7-360	11	27.28
BBT50-HDC19L-90	18	9.24
BBT50-HDC24L-90	18	9.90
BBT50-HDC31L-90	18	9.90
BBT50-OCK7N-165	24	27.00
BCV40-HDC19-75	18	3.08
BCV40-HDC24-75	18	3.30
BCV40-HDC31-75	18	3.96
BCV50-HDC19L-90	18	8.14
BCV50-HDC24L-90	18	8.58
BCV50-HDC31L-90	18	8.80
BCV50H-FMH60-90	96	12.15
BT30-CK1-105	10	1.12
BT30-CK2-75	10	.66
BT30-CK2-120	10	1.25
BT30-CK3-80	10	.99
BT30-CK3-120	10	1.47
BT30-CK4-85	10	1.01
BT30-CK4-120	10	1.67
BT30-CK5-120	10	1.76
BT30-CK6-135	10	2.86
BT40-CK1-105	10	2.42
BT40-CK2-80	10	2.20
BT40-CK2-120	10	2.64
BT40-CK3-85	10	2.42
BT40-CK3-135	10	2.86
BT40-CK4-90	10	2.64

Catalog Number	Page	Weight
BT40-CK4-135	10	3.30
BT40-CK5-105	10	2.64
BT40-CK5-135	10	3.52
BT40-CK6-135	10	3.52
BT50-CK1-135	11	8.80
BT50-CK2-90	11	8.36
BT50-CK2-150	11	8.80
BT50-CK3-95	11	8.58
BT50-CK3-165	11	9.46
BT50-CK4-105	11	9.46
BT50-CK4-165	11	9.90
BT50-CK4-225	11	10.78
BT50-CK5-120	11	8.80
BT50-CK5-165	11	10.34
BT50-CK5-240	11	12.98
BT50-CK5-285	11	14.30
BT50-CK6-165	11	10.56
BT50-CK6-240	11	14.74
BT50-CK6-300	11	18.04
BT50-CK7-210	11	11.00
BT50-CK7-300	11	20.68
BT50-CK7-360	11	27.28
C.750-1/2	120	.16
C.750-1/4	120	.19
C.750-3/8	120	.19
C.750-5/16	120	.18
C.750-5/8	120	.10
C.750-7/16	120	.17
C.750-9/16	120	.14
C1.250-1	120	.42
C1.250-1/2	120	.70
C1.250-1/4	120	.70
C1.250-11/16	120	.60
C1.250-13/16	120	.57
C1.250-15/16	120	.48
C1.250-3/8	120	.71
C1.250-5/16	120	.69
C1.250-5/8	120	.66
C1.250-7/16	120	.70
C1.250-7/8	120	.53
C1.250-9/16	120	.66
C5-CKB3-55	11	1.55
C5-CKB4-48	11	1.70
C5-CKB5-50	11	1.95
C5-CKB6-50	11	2.25
C6-CKB3-65	11	2.35

Catalog Number	Page	Weight
C6-CKB4-58	11	2.45
C6-CKB5-48	11	2.60
C6-CKB6-59	11	3.35
C8-CKB6-74	11	5.65
C8-CKB7-73	11	7.00
CK4-MEGAER16-60	119	1.69
CK4-MEGAER20-70	119	2.20
CK4-MGT12-67	122	1.32
CK4-MGT6-62	122	1.10
CK44DP-120	20	2.90
CK5-MEGAER25-80	119	3.74
CK5-MEGAER32-80	119	4.62
CK5-MGT20-87	122	2.80
CK55DP-150	20	5.70
CK6-MEGAER32-90	119	5.72
CK66DP-180	20	12.30
CK7-MGT36-137	122	15.00
CKB1-C2232-45B-20	113	.20
CKB2-C0525	112	.30
CKB3-C3242-45B-20	113	.40
CKB3-C5262-45B-20	113	.70
CKB4-C1040	112	.60
CKB4-C4252-45B-20	113	.80
CKB5-C3060	112	1.65
CKB5-C5262-45B-20	113	1.05
CKB6-C50100	112	3.10
CM10C1	113	.10
CM10C1SE	113	.10
CV40-OCK6N-144	24	13.40
CV50-OCK6N-142	24	15.90
CV50-OCK7N-165	24	27.00
CW1206A	112	.10
CW1909A	112	.15
CW3115A	112	.30
FK58-62	120	.50
FK80-90	120	.85
HSK40-CP	13	.04
HSK50-CP	13	.04
HSK63-CP	13	.06
HSK100-CP	13	.11
HSK-A40-CK1-73	12	.84
HSK-A40-CK2-40	12	.57
HSK-A40-CK2-85	12	.90
HSK-A40-CK3-45	12	.68
HSK-A40-CK3-80	12	1.06
HSK-A40-CK4-53	12	.90

Catalog Number	Page	Weight
HSK-A40-CK4-73	12	1.25
HSK-A50-CK1-73	12	1.10
HSK-A50-CK2-85	12	1.32
HSK-A50-CK3-80	12	1.54
HSK-A50-CK4-73	12	1.76
HSK-A50-CK5-83	12	2.20
HSK-A63-CK1-78	12	1.98
HSK-A63-CK2-90	12	2.20
HSK-A63-CK3-100	12	2.42
HSK-A100-CK1-103	12	5.50
HSK-A100-CK2-115	12	5.72
HSK-A100-CK4-118	12	6.60
HSK-A100-CK4-178	12	7.70
HSK-A100-CK4DP-241	20	9.46
HSK-A100-CK5-228	12	11.00
HSK-A100-CK5DP-303	20	14.30
HSK-A100-CK6-169	12	11.66
HSK-A100-CK6DP-379	20	24.64
HSK-F63-CK1-78	13	1.76
HSK-F63-CK2-90	13	1.76
HSK-F63-CK3-100	13	2.20
HSK-F63-CK4-93	13	2.64
HSK-F63-CK5-83	13	2.86
HSK-F80M-CK6-75	13	6.60
LP-A	24	.35
LP-B	24	.30
LP-C	24	.25
MES-65	24	.25
MES-90	24	.35
MGR16	122	.25
MGR20	123	.30
MGR30	123	.60
MGT6-No.10-1.25	122	.35
MGT6-No.10-3	122	.55
MGT6-No.10-4	122	.60
MGT6-No.10-6	122	.80
MGT6-No.10-8	122	1.05
MGT6-No.12-1.25	122	.35
MGT6-No.12-3	122	.55
MGT6-No.12-4	122	.60
MGT6-No.12-6	122	.80
MGT6-No.12-8	122	1.00
MGT6-No.6-1.25	122	.35
MGT6-No.6-3	122	.55
MGT6-No.6-4	122	.65
MGT6-No.6-6	122	.85

Catalog Number	Page	Weight
MGT6-No.8-1.25	122	.35
MGT6-No.8-3	122	.55
MGT6-No.8-4	122	.60
MGT6-No.8-6	122	.80
MGT12-AU1/4-1.25	123	.50
MGT12-AU1/4-3	123	.75
MGT12-AU1/4-4	123	.85
MGT12-AU1/4-6	123	1.15
MGT12-AU1/4-8	123	1.45
MGT12-AU5/16-1.25	123	.50
MGT12-AU5/16-3	123	.75
MGT12-AU5/16-4	123	.85
MGT12-AU5/16-6	123	1.15
MGT12-AU5/16-8	123	1.45
MGT12-AU7/16-1.25	123	.50
MGT12-AU7/16-3	123	.75
MGT12-AU7/16-4	123	.85
MGT12-AU7/16-6	123	1.15
MGT12-AU7/16-8	123	1.45
MGT20-AP1/4-1.5	123	1.25
MGT20-AP1/4-3.5	123	1.90
MGT20-AP1/4-4.5	123	2.15
MGT20-AP1/4-6	123	2.60
MGT20-AP1/8-1.5	123	1.30
MGT20-AP1/8-3.5	123	1.90
MGT20-AP1/8-4.5	123	2.20
MGT20-AP1/8-6	123	2.65
MGT20-AU1/2-1.5	123	1.30
MGT20-AU1/2-3.5	123	1.95
MGT20-AU1/2-4.5	123	2.25
MGT20-AU1/2-6	123	2.70
MGT20-AU11/16-1.5	123	1.25
MGT20-AU11/16-3.5	123	1.85
MGT20-AU11/16-4.5	123	2.15
MGT20-AU11/16-6	123	2.60
MGT20-AU3/4-1.5	123	1.25
MGT20-AU3/4-3.5	123	1.85
MGT20-AU3/4-4.5	123	2.15
MGT20-AU3/4-6	123	2.60
MGT20-AU3/8-1.5	123	1.25
MGT20-AU3/8-3.5	123	2.00
MGT20-AU3/8-4.5	123	2.25
MGT20-AU3/8-6	123	2.70
MGT20-AU5/8-1.5	123	1.25
MGT20-AU5/8-3.5	123	1.90
MGT20-AU5/8-4.5	123	2.20

Catalog Number	Page	Weight
MGT20-AU5/8-6	123	2.65
MGT20-AU9/16-1.5	123	1.30
MGT20-AU9/16-3.5	123	1.90
MGT20-AU9/16-4.5	123	2.25
MGT20-AU9/16-6	123	2.65
MGT36-AU7/8-2.5	123	—
MGT36-AU1-2.5	123	—
MGT36-AU1.1/8-2.5	123	—
MGT36-AU1.1/4-2.5	123	—
MGT36-AU1.3/8-2.5	123	—
MGT36-AP3/8-2.5	123	—
MGT36-AP1/2-2.5	123	—
MGT36-AP3/4-2.5	123	—
MGT36-AP1-2.5	123	—
MT3-CK1-73	14	0.88
MT3-CK2-100	14	1.10
MT3-CK3-100	14	1.32
MT3-CK5-100	14	1.76
MT4-CK1-73	14	1.54
MT4-CK2-100	14	1.76
MT4-CK3-100	14	1.98
MT4-CK4-100	14	2.20
MT4-CK5-100	14	2.42
MT4-CK6-125	14	3.52
MT5-CK4-125	14	4.62
MT5-CK5-125	14	7.26
MT5-CK6-125	14	5.50
MT6-CK6-125	14	11.00
OCA31-21	18	0.10
OCA31-23	18	0.10
OCA31-27	18	0.07
TS14-S	137	.80
TS18-S	137	1.00
TS22-S	137	1.25



BIG Kaiser Precision Tooling Inc. is not just boring tools. We're tool holders, cutting tools, tool presetters, zero-point workholding, accessories and so much more. We're BIG-PLUS®, CAT, BT, HSK and BIG CAPTO. We're tightening tolerances, reducing setup and cycle times, increasing tool life, and enhancing performance while driving down cost. We're delivering high-performance tooling products and ingenuity for shops that demand results.



BIG KAISER®

PRECISION TOOLING INC.

2600 Huntington Blvd, Hoffman Estates, IL 60192
Phone: 847.228.7660 • Fax: 847.228.0881
www.bigkaiser.com • bigkaiser@bigkaiser.com