

10x10 Foot

Portable Gazebo with Netting



Assembly Instructions

Made in China

The owner's manual contains important safety information as well as assembly, use and maintenance instructions. Keep the packaging and bags away from children and dispose of all packaging properly before use. Keep this manual for future reference.



**PLEASE DO NOT
RETURN THIS
PRODUCT
TO THE STORE**

We will be happy to correct any problems that you may have, or answer any of your questions regarding the purchase of this product. Please contact us at our Toll Free customer service number 1-800-599-8898 for any assistance and replacement parts. Thank You.

Dist. by TDC USA, Inc. Fairfield, NJ 07004
©2022 All Rights Reserved.
Made in China
Item 21951 (sand); 22077 (gray)
www.tdcusainc.com

 **WARNING!**

- **Keep all children and pets away from assembly area. Children and pets should be supervised when they are in the area of the product construction.**
- **Some parts may contain sharp edges. When assembling and using this product, basic safety precautions should always be.**
- **Please read all the instructions and warnings before assembling. In order to make the whole product adjust to the best, please install all the screws on the product and tighten all the screws after adjusting the product which can stand on the floor even. Not intended for commercial use.**
- **Check all bolts for tightness before use.**
- **IMPORTANT - check and tighten bolts often to keep them secure**

- **CHOKING HAZARD** - Small parts. Not suitable for children under 36 months. The product contains small parts, keep children away when assembling.
- **ADULT ASSEMBLY REQUIRED.** Always remove protective material and poly bags and dispose before assembly.

WARNING

KEEP ALL FLAME AND HEAT SOURCES AWAY FROM THIS TENT FABRIC. (This tent is made with fabric that meets CPAI-84 Specification for flame resistance. It is NOT fire proof. The fabric will burn if left in continuous contact with any flame source.) The application of any foreign substance to the tent fabric may render the flame-resistant properties ineffective.

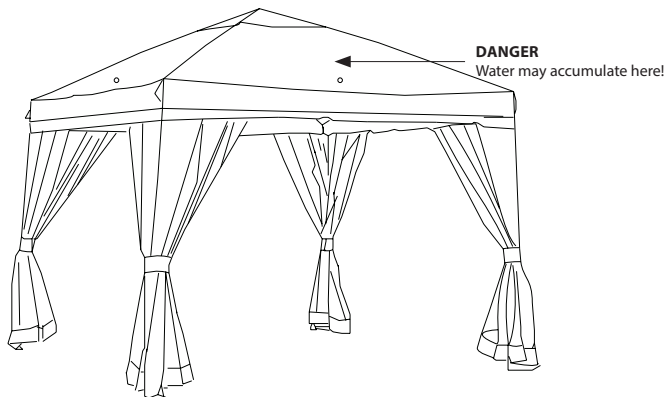

Please read, and follow the instructions within this manual before using this gazebo for the first time. Please review the diagram on page 17 to familiarize yourself with descriptions of the individual parts that make up the gazebo frame. Be careful not to pinch fingers or hands in moving parts when opening or closing this gazebo. **Do not use excessive force during any part of set up.**

Do not use this gazebo in strong wind and rain. Wind and rain can damage the canopy, metal parts of the frame, and could result in injury to you and others.

The gazebo is designed to provide shade from the sun only. The canopy is not waterproof, and not intended to be used when raining. Water will sit easily on the canopy fabric, and the weight of the water will severely damage metal parts of the frame.

When raining or windy, or expecting rain, wind, snow, or other stormy conditions, close the gazebo as instructed within this manual, and stow it away out of the elements. This gazebo is not a permanent structure, and is intended to be taken down when not in use. This gazebo is not intended to be anchored to a patio deck or concrete surface. Please take a moment to review the Limited Warranty policy found on page 18.

CARE & MAINTENANCE

- Wash frame and canopy with a mild solution of soap and water, rinse thoroughly. Dry completely. Do not use bleach or solvents.
- Inspect frame periodically to ensure all bolts and nuts are tight.
- Always return the gazebo to the carry bag after use. Be sure the gazebo is completely dry before storing it.

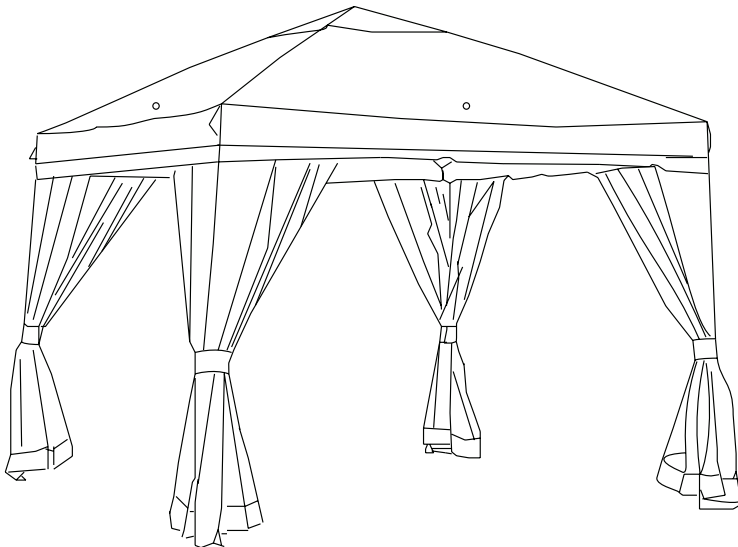
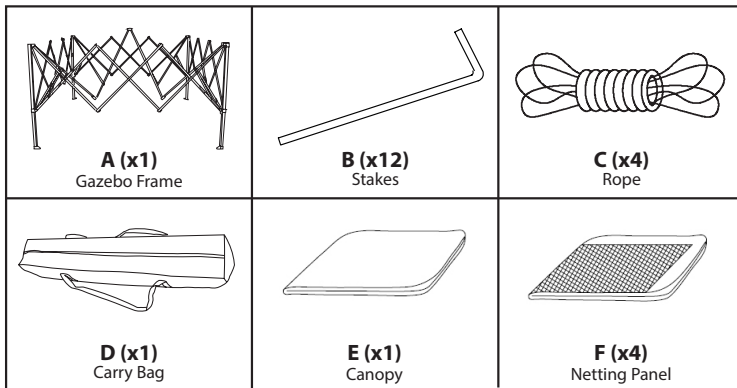

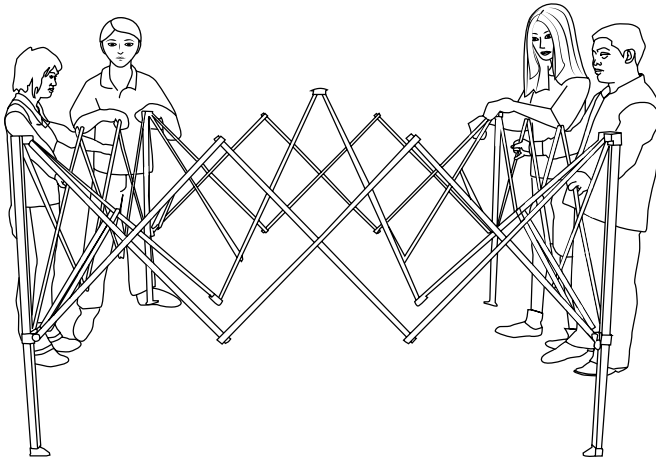

Step 1:

Stand frame upright. Begin with having four people stand at each corner, grasp legs, slightly lift the frame off the ground and step backward, stop once you reach a full arms' length.

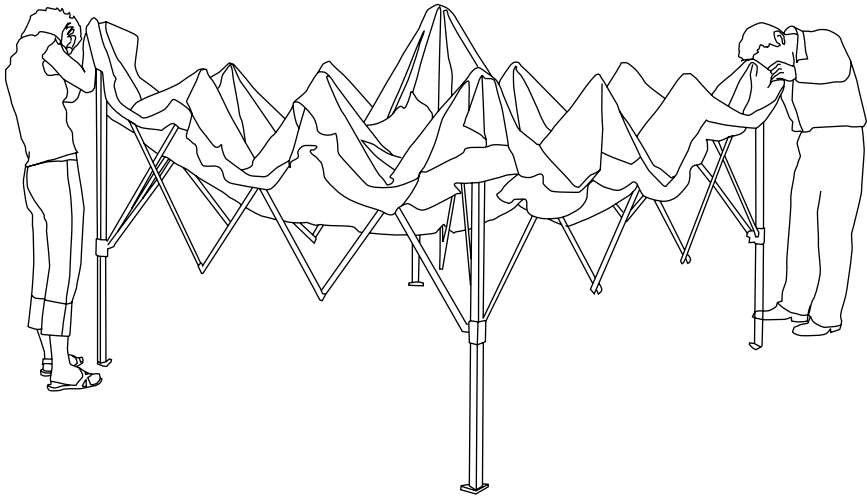

Step 2:

Unfold the fabric canopy pack, place the fabric top over the top frame. Use the fasteners to secure each corner of the cover to the corner of the frame.



Step 3:

Having four people at either corner, grasp the bottom of the middle frame section (crossbeams) where it forms a diamond. Lift slightly and slowly walk backward until the frame is fully extended. Be careful not to pinch your finger or pull backward too hard as this may result in the bending of crossbeams.

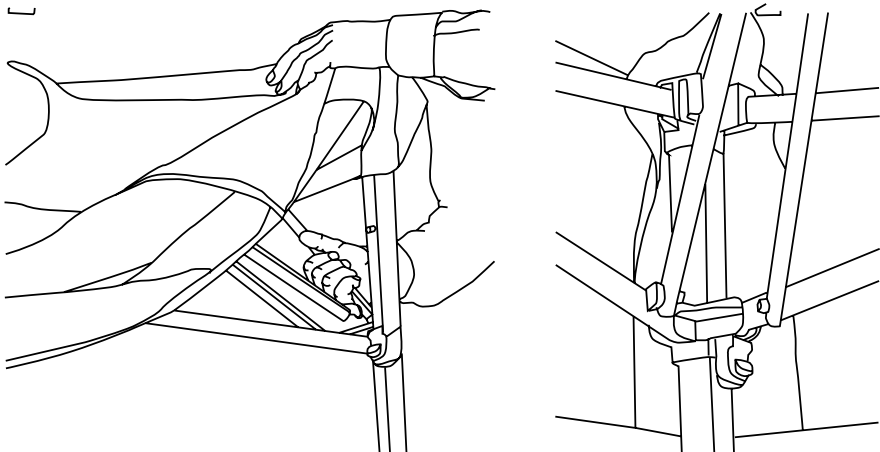

Step 4:

Engage the Leg Hinge at each corner by pushing up on it with one hand while holding down the top of the leg with the other hand. Repeat this operation at remaining corners.

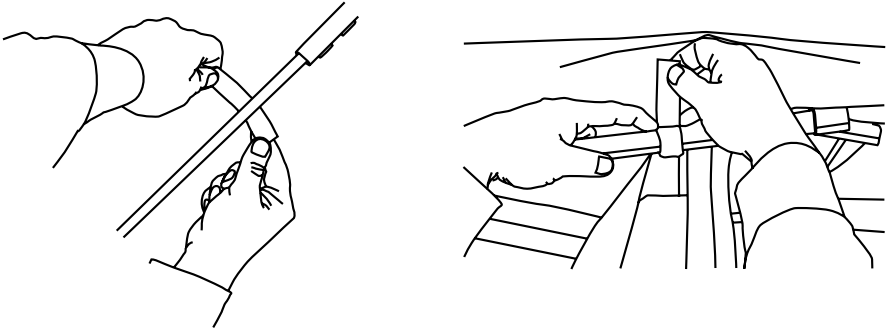

Step 5:

To secure the fabric top to the frame, please wrap the hook and loops around roof tubes and crossbeams.

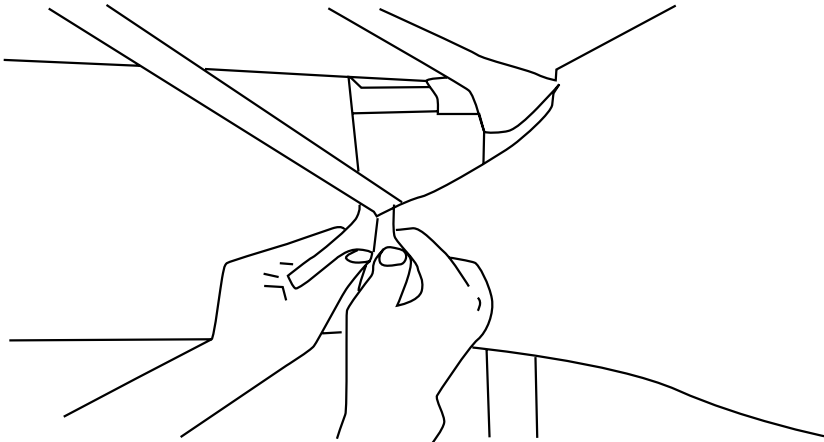

Step 6:

Pull down the inside valances (curtain) to cover the beam tubes. Attach the hook and loop straps on the adjacent valances together for clean look.

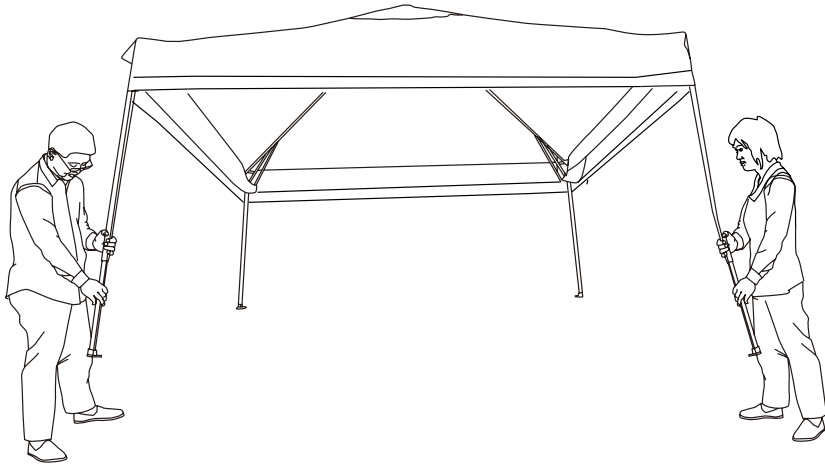

Step 7:

Lift two adjacent outer legs and pull out inner legs gently until spring loaded snap button pops in position. Repeat on the remaining legs. The gazebo offers three height levels. To adjust: lift leg up, carefully press the push button and slowly pull out the inner leg until the snap button pops in next position. Repeat for the other legs.

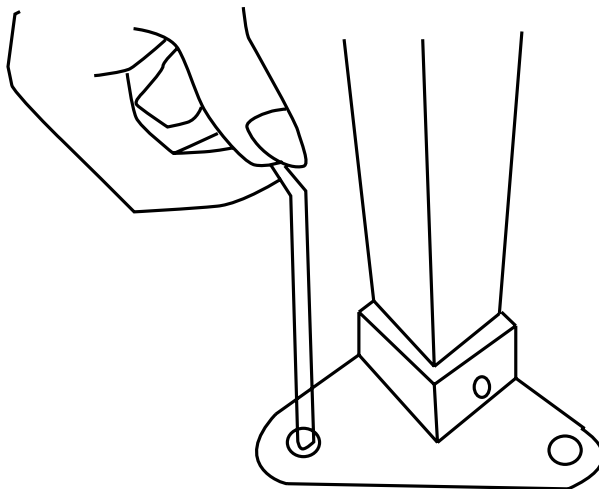

Step 8:

Stake down the gazebo by driving the two anchors through the holes on each foot base. This will keep the leg from moving sideways in mild weather conditions.

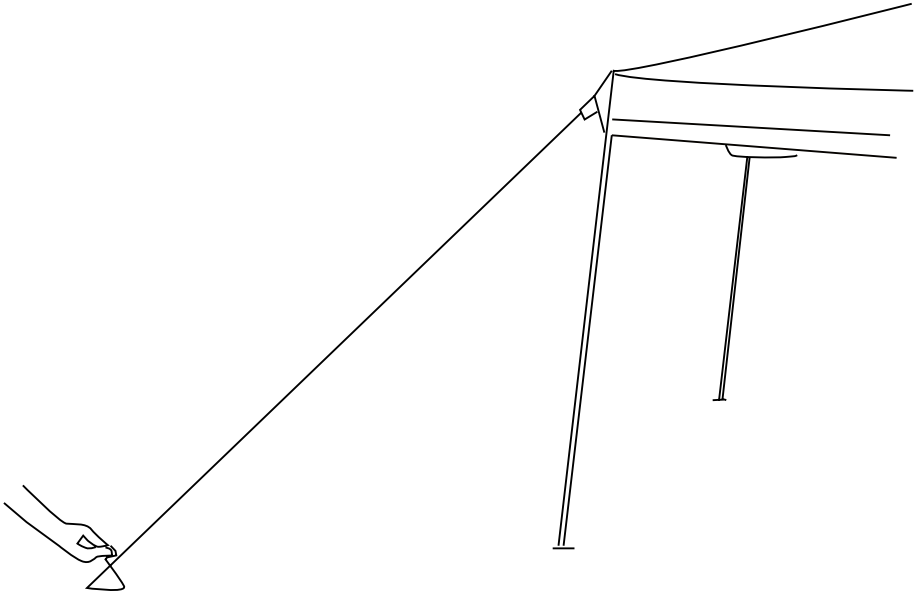

Step 9:

Measure out from the leg to a proper distance and secure the four big anchors to ground at 45 degree angle. Tie up one end of each guide rope to triangular shaped rope holder located on the outside fabric corners. Tie the other end of each rope to the anchor on the ground. Make sure the guide ropes have the proper tension.

FOR ADDITIONAL STABILITY, THIS GAZEBO CAN BE SECURED TO THE GROUND WITH ANCHORS AND GUIDE ROPES.

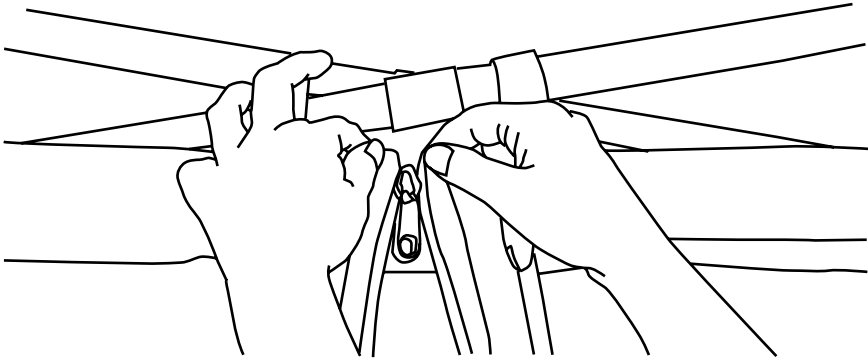

Step 1:

Unpack the screen and corner curtain combo kit, locate the zipper end of the screen panel, position it in the middle of the two legs. Place the combo out around the frame.

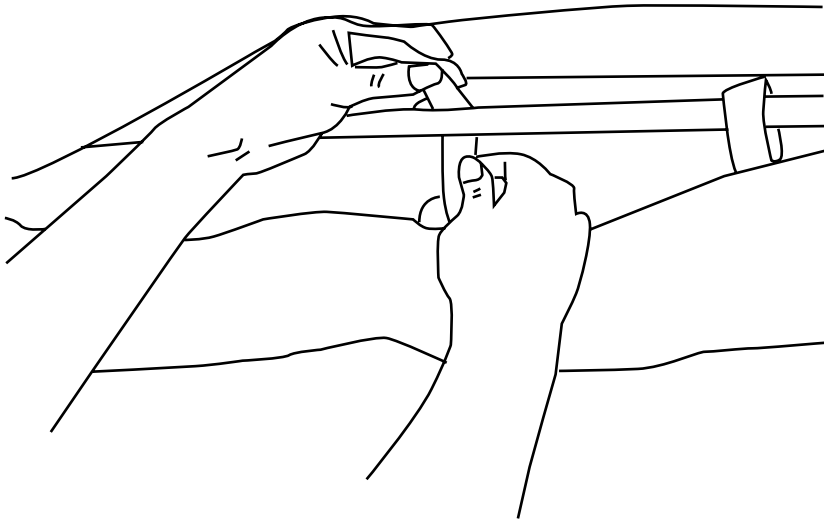

Step 2:

Lift the inside valance, match the combo up the frame. Attach the combo panels to cross tubes by hook and loop straps.

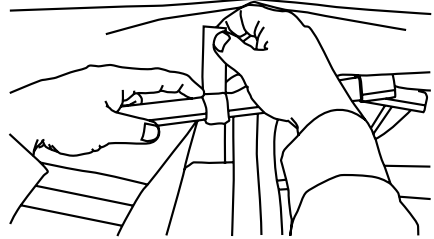
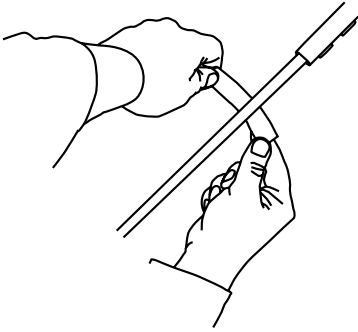

Step 3:

To secure the fabric top to the frame, please wrap the hook and loops around roof tubes and crossbeams.

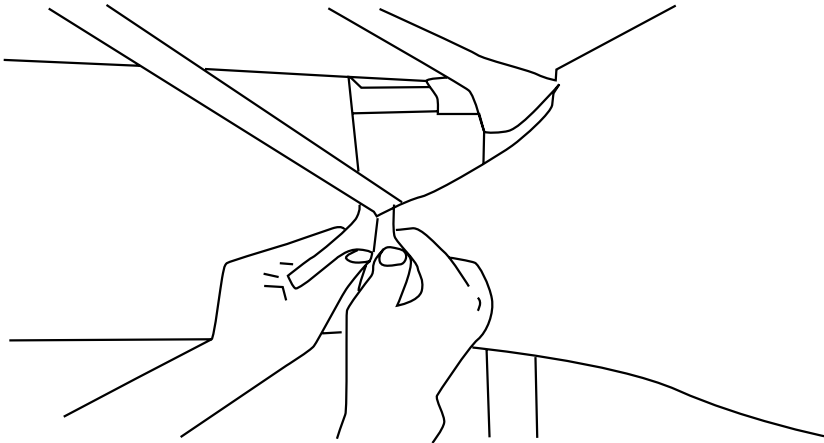

Step 4:

Pull down the inside valances (curtain) to cover the beam tubes. Attach the hook and loop straps on the adjacent valances together for clean look.

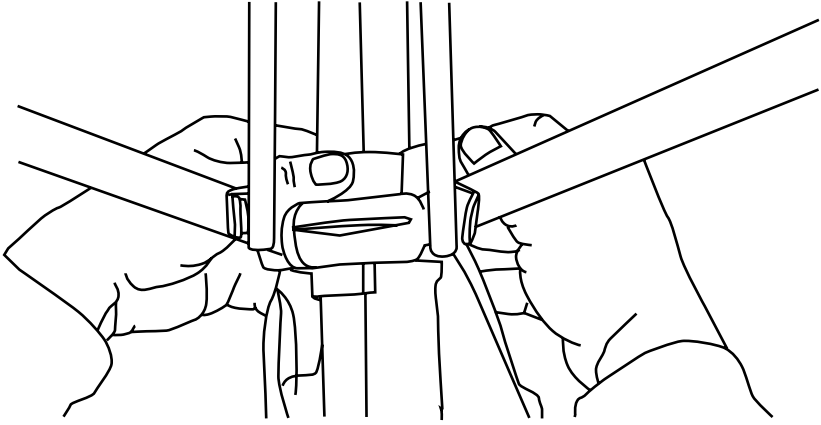

Step 5:

Tuck the upper corner of screen up to the corner of outside valance. Secure to the upper corner frame with hook and loop straps.

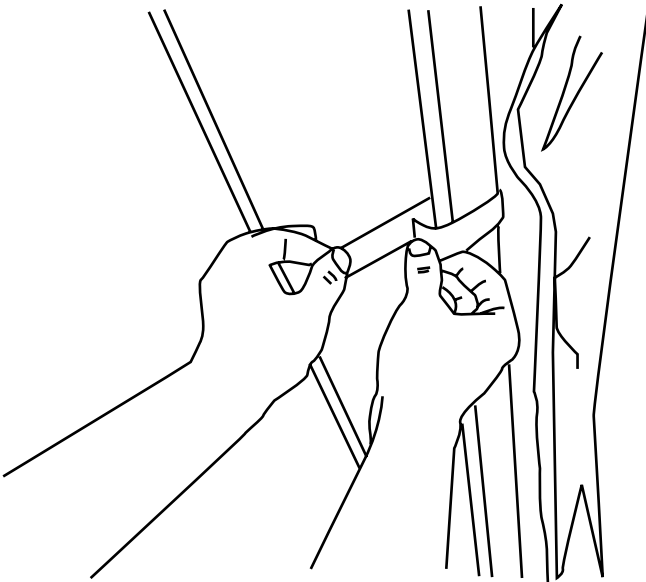

Step 6:

Further secure combo to legs with hook and loop straps.

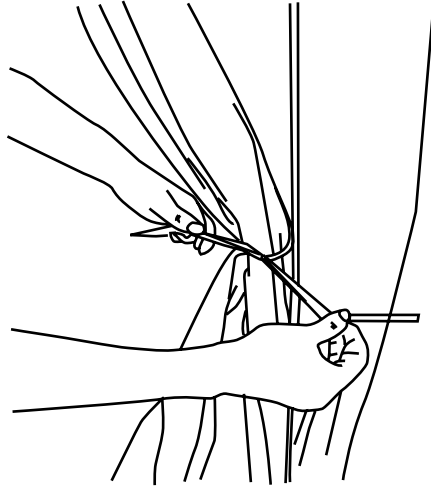

Step 7:

Zip the screen all around to keep insects out or leave one side unzipped as an entrance. Make the entrance by adjusting the attachment location of combo panels at crossbeams. Then you may hold back the combo panels with tie-backs for a drapery looks.

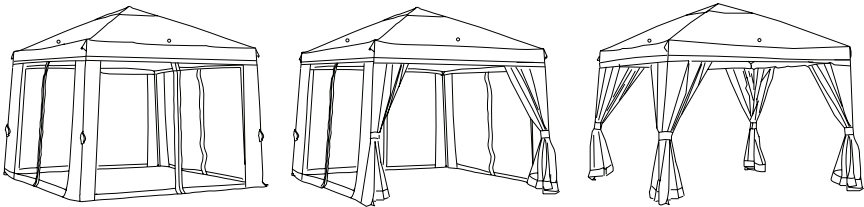

Please review the diagram on page 17 to familiarize yourself with part descriptions of the individual parts that make up the gazebo frame.

NOTICE: Please read instructions below to avoid damaging parts to the gazebo frame. Do not use excessive force when closing the gazebo.

1. Remove Ropes (C) and Stakes (B) that tie down each corner of the gazebo.
2. Remove Stakes (B) securing each *telescopic leg* to the ground.
3. Collapse each *telescopic leg* by depressing the push-pins, and pushing the bottom half of the legs into the upper half. Be careful not to pinch fingers or hands in moving parts.
4. Depress push-pins within the *sliding leg hinges* at the top of *telescopic legs*, and push the hinges down to the bottom of collapsed *telescopic legs*.
5. With one person at each corner holding a collapsed *telescopic leg*, begin stepping inward to close the gazebo frame at the same pace. If anyone meets resistance while closing the frame, everyone should take a step or two outward to open the frame some before trying to close it again.
6. Carefully place the closed Gazebo Frame (A) in its Carrying Bag (D).

WARNING

Keep all flame and heat sources away from this tent fabric. This tent is made with fabric that meets CPAI-84 specifications for flame resistance. It is not fire proof. The fabric will burn if left in continuous contact with any flame source. The application of any foreign substance to the tent fabric may render the flame-resistant properties ineffective.

Portable Gazebo Diagram | 16

Please review the diagram below to familiarize yourself with part descriptions. When needing assistance from our customer support team, please use these descriptions to help identify what concerns you are having with any part to this Portable Gazebo.

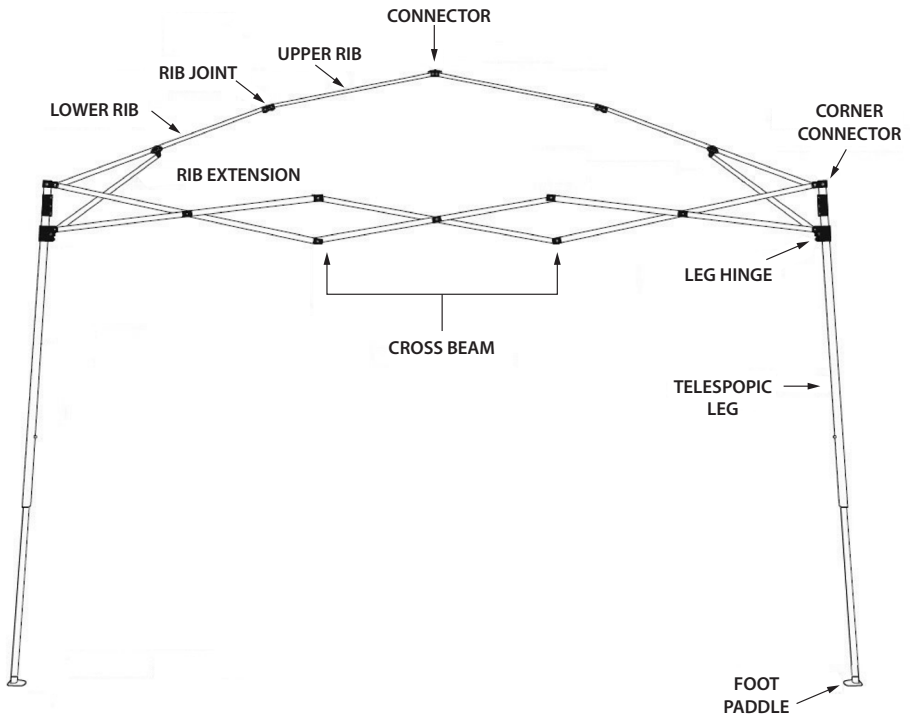

LIMITED WARRANTY

Please contact our service hotline by phone, email, or fax when needing assistance with assembly or with faulty parts. This allows us to provide support in the event of possible operator errors.

All furniture manufactured and sold by TDC USA, Inc. is warranted to the original purchaser against defects in workmanship and materials. If a product manufactured by TDC fails during the first year from date of purchase under the terms of our limited warranty, TDC will replace the item at no charge. After one year, it will be the original purchaser's responsibility to pay for freight and packing. TDC reserves the right, in the case of discontinued or out of production models, to replace with an item of similar quality. (Glass breakage is not warranted.)

NOTE: You must retain original receipt to obtain warranty!

FRAMES:

Frames are warranted against defects in materials and workmanship from the date of original purchase. Damage to frames or welds due to commercial use, improper assembly, exposure to water and sub-freezing temperatures, and/or abuse are not covered.

FABRIC:

Fabric on cushions, slings, and umbrellas is warranted against separation at the seams. Fading, mildew, and/or discoloration due to exposure to elements, chemicals, and spills are not covered.

POWDER COAT AND/OR PAINT:

The finish is warranted against blistering, peeling, or cracking. Fading resulting from exposure to the elements, chemicals, and spills are not covered. Scratches and chips due to normal wear and use are not covered.

FREIGHT & PACKING:

TDC will be responsible for shipping, handling, and packaging charges for all valid warranty claims.

CARE & MAINTENANCE:

Be careful to never allow water build up in frames as this will cause corrosion and freeze damage in cold climates. Wash all frames with a solution of mild soap and water. Rinse with clean water and dry with a soft absorbent cloth towel. Frames can be treated with a liquid wax for maximum protection against UV rays and/or salty damp air. If your set includes cushions, slings, and/or an umbrella, they may be cleaned by hand with a solution of soap and water with a clean water rinse.

LIMITED WARRANTY EXCLUSIONS:

- Damage caused by acts of nature
- Wind damage
- Failure caused by unreasonable, unanticipated, or abusive use
- Failure caused by a lack of reasonable and necessary care and maintenance
- Normal fade of fabrics, upholstery, or woven materials
- Glass table tops
- Bursting or cracking of tubing due to exposure to water and freezing temperatures
- Changes in wood color due to the natural aging of the wood

***A sales receipt must be provided to validate
1-Year Limited Warranty.***

Customer Service:

Monday - Friday • 9:00 am - 5:00 pm

Phone: 800-599-8898

Email: support@tdcusainc.com

**TDC USA, Inc.
5 Industrial Rd, STE 1
Fairfield, NJ 07004-3017**



10x10 Foot

Portable Gazebo with Netting

Dist. by TDC USA, Inc. Fairfield, NJ 07004
©2022 All Rights Reserved. Made in China.

Item #21951 (sand); #22077 (gray)

Questions and Comments

1-800-599-8898 (9 am - 5 pm EST)

www.tdcusainc.com