

# Grill Gazebo

Steel Frame with Powder Coating



## Assembly Instructions

### **Made in China**

The owner's manual contains important safety information as well as assembly, use and maintenance instructions. Keep the packaging and bags away from children and dispose of all packaging properly before use. Keep this manual for future reference.

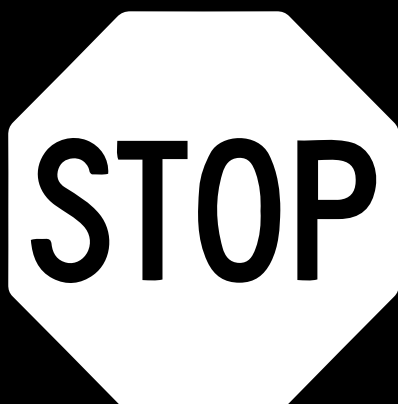

**PLEASE DO NOT  
RETURN THIS  
PRODUCT  
TO THE STORE**

We will be happy to correct any problems that you may have, or answer any of your questions regarding the purchase of this product. Please contact us at our Toll Free customer service number 1-800-599-8898 for any assistance and replacement parts. Thank You.











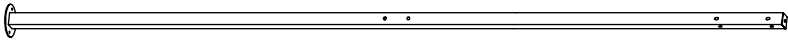
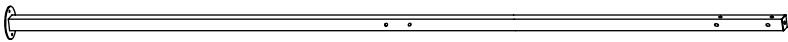
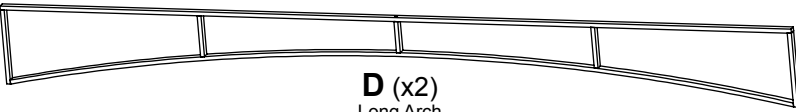
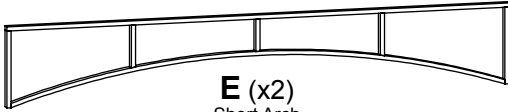
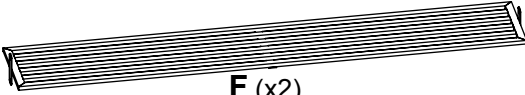



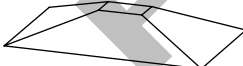

Dist. by TDC USA, Inc. Fairfield, NJ 07004  
©2023 All Rights Reserved.  
Made in China  
Item 21581  
[www.tdcusainc.com](http://www.tdcusainc.com)

**⚠ WARNING!**

- Keep all children and pets away from assembly area. Children and pets should be supervised when they are in the area of the product construction.
- Some parts may contain sharp edges. When assembling and using this product, basic safety precautions should always be.
- Please read all the instructions and warnings before assembling. In order to make the whole product adjust to the best, please install all the screws on the product and tighten all the screws after adjusting the product which can stand on the floor even. Not intended for commercial use.
- Check all bolts for tightness before use.
- **IMPORTANT** - check and tighten bolts often to keep them secure

• **CHOKING HAZARD** - Small parts. Not suitable for children under 36 months. The product contains small parts, keep children away when assembling.

• **ADULT ASSEMBLY REQUIRED.**  
Always remove protective material and poly bags and dispose before assembly.

					
<b>A (x1)</b> Pole					
					
<b>B (x1)</b> Pole					
					
<b>C (x2)</b> Pole					
					
<b>D (x2)</b> Long Arch					
					
<b>E (x2)</b> Short Arch					
					
<b>F (x2)</b> Shelf					
					
<b>G (x4)</b> Two-Tier Ribs	<b>H (x2)</b> Canopy Rib	<b>I (x1)</b> Connector			
					
<b>J (x6)</b> Rib Brace	<b>K (x1)</b> Utensil Rack	<b>L (x1)</b> Bottle Opener			
					
<b>M (x8)</b> Stake	<b>N (x1)</b> Main Canopy	<b>O (x1)</b> Small Canopy			
					
<b>P (x9)</b> M6x10 Bolt	<b>Q (x2)</b> M6x15 White Zinc Bolt	<b>R (x8)</b> M6x15 Black Zinc Bolt	<b>S (x16)</b> M6x20 Bolt	<b>T (x6)</b> M6x28 Bolt	<b>U (x6)</b> M6 Nut

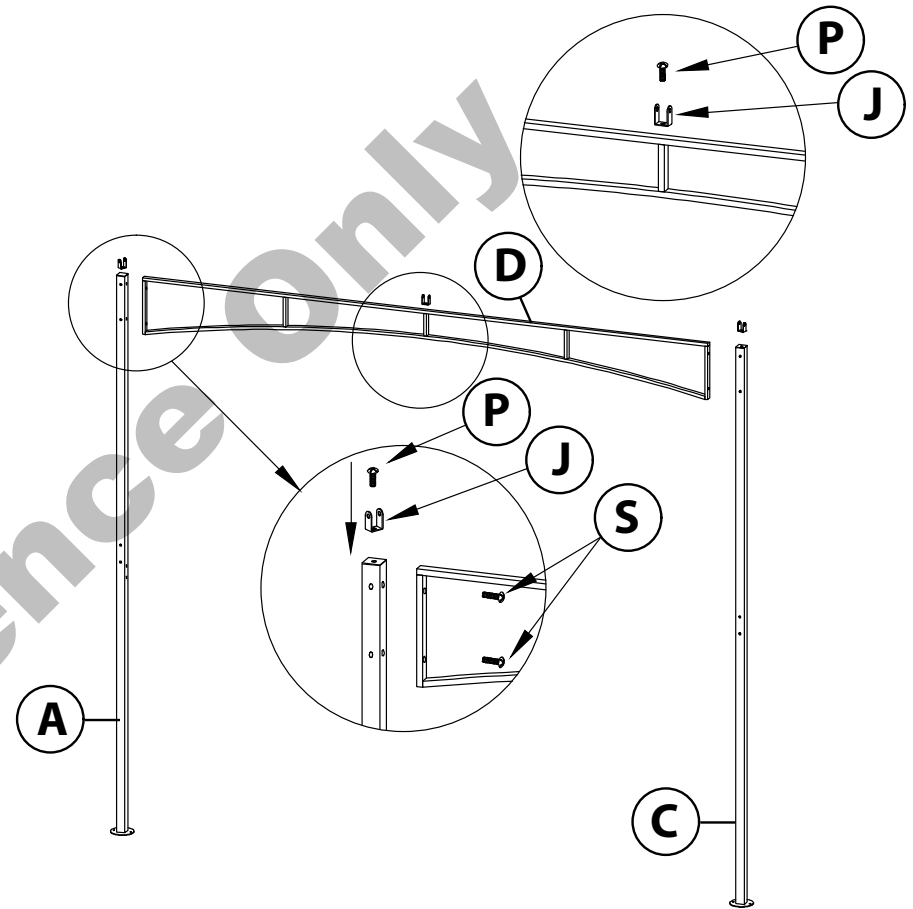

**Step 1:**

Insert one M6x10 Bolt (P) through the eyelet on the bottom of Rib Brace (J), and into the bolt-threading at the top of Pole (A). Follow this step to assemble three additional Rib Brace (J) to the tops of the remaining Poles (B & C).

Insert one M6x10 Bolt (P) through the eyelet on the bottom of Rib Brace (J), and into bolt-threading at the top-center of Long Arch (D). Follow this step to assemble the remaining Rib Brace (J) to the second Long Arch (D).

Insert two M6x20 Bolts (R) through eyelets at the end of Long Arch (D), and into the bolt-threading near the top of Pole (A). Follow this step to connect the opposite end of Long Arch (D) to Pole (C). Follow these steps to assemble the second Long Arch (D) to Pole (B), and the second Pole (C).

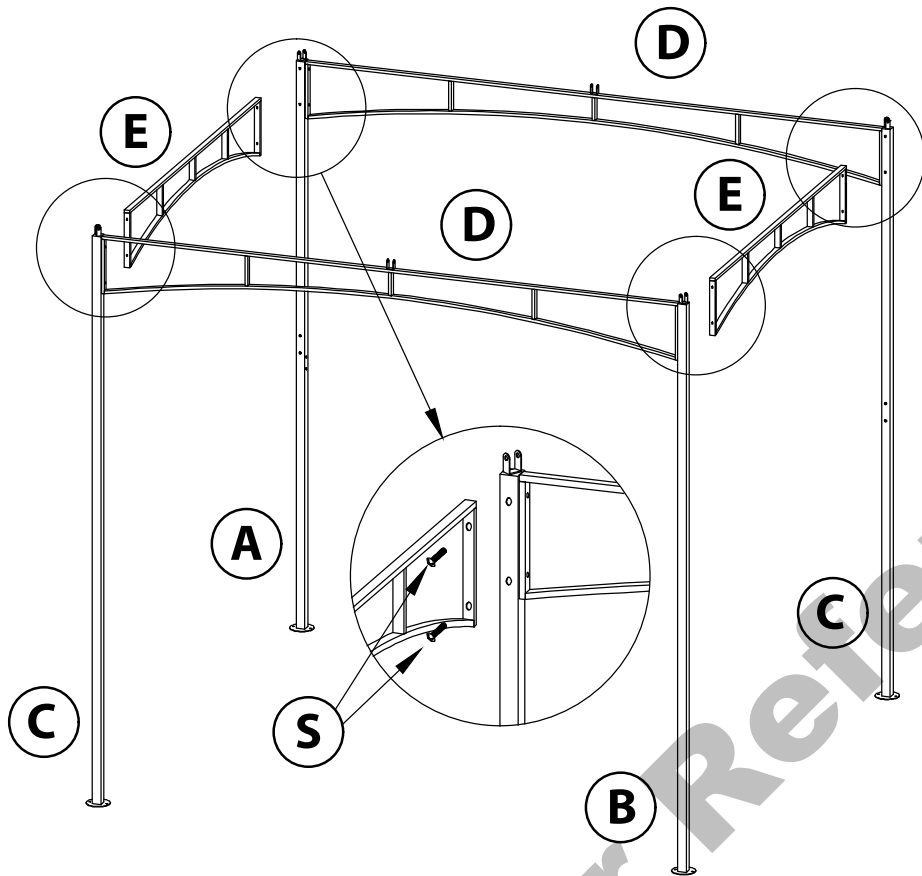

### Step 2:

Insert two M6x20 Bolts (S) through eyelets at the end of Short Arch (E), and into the bolt-threading near the top of Pole (A). Follow this step to connect the opposite end of Short Arch (E) to Pole (C). Follow these steps to assemble the second Short Arch (E) to Pole (B), and the second Pole (C). When complete, both Poles (C) should be perpendicular from one another, while Pole (A) and Pole (B) are also perpendicular.

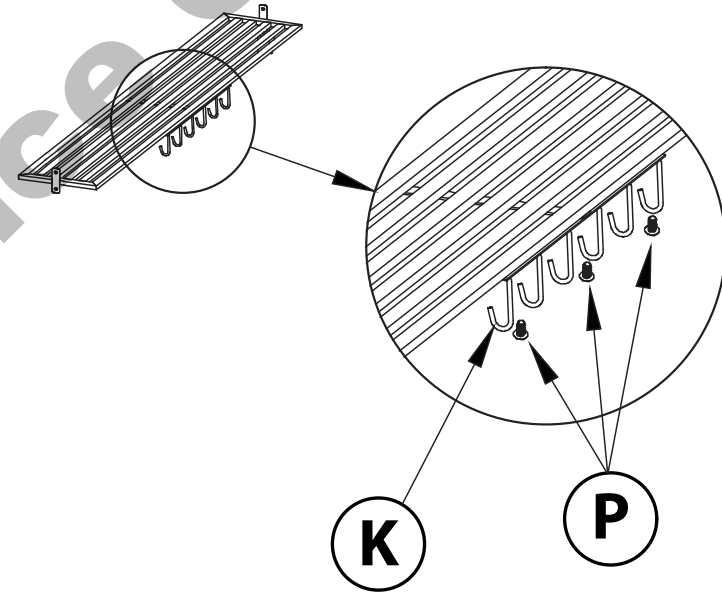

### Step 3:

Insert three M6x10 Bolts (P) through eyelets on the Utensil Rack (K), and into the bolt-threading found underneath one Shelf (F). See the illustration above for the correct orientation on how this part should be installed.

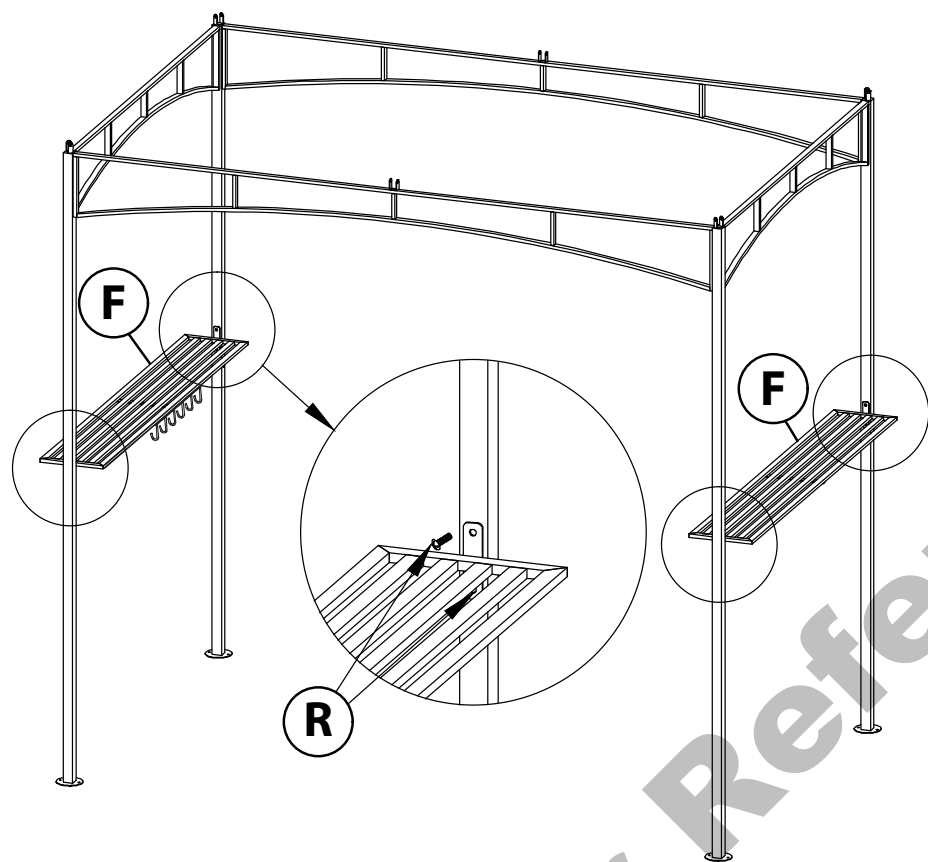

### Step 4:

Insert two M6x15 Black Zinc Bolts (R) through eyelets on the bracket at one end of Shelf (F) with previously assembled Utensil Rack (K), and into the bolt-threading found in the center of Pole (A). Please note that the Utensil Rack (K) on this shelf should be accessible to the anyone using a grill underneath this product. Follow this step to connect the opposite end of Shelf (F) to Pole (C). Follow these steps to assemble the second Shelf (F) to Pole (B), and the second Pole (C).

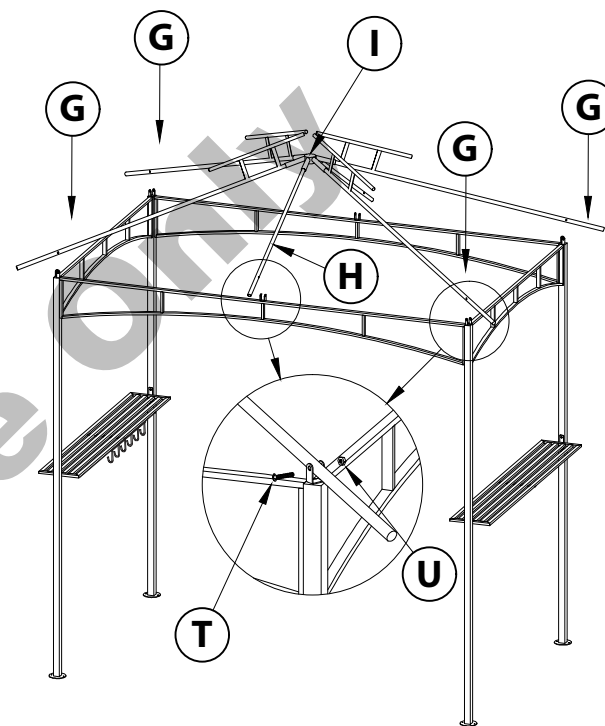

### Step 5:

Insert the longer ribs of the four Two-Tier Ribs (G) into the longer ends of the Connector (I) until they are locked in place. Insert the two Canopy Ribs (H) into the shorter ends of Connector (I) until they are locked in place.

Place assembled ribs with connector over the height of assembled frame. Place ends of Two-Tier Ribs (G) in between Rib Braces (J) at the tops of each Pole (A, B, & C). Place ends of Canopy Ribs (H) in between Rib Braces (J) found at the center of both Long Arches (D).

Insert one M6x28 Bolt (T) through the eyelet on the side of Rib Braces (J), and through the eyelets on the lower rib of Two-Tier Ribs (G), through eyelet on opposite side of part J, and secure these parts together using M6 Nut (U). Follow this step to assemble the remaining part G's to the part J's found at the tops of each pole.

Insert one M6x28 Bolt (T) through the eyelet on the side of Rib Braces (J), and through the eyelets at the end of Canopy Rib (H), through eyelet on opposite side of part J, and secure these parts together using M6 Nut (U). Follow this step to assemble the remaining part H to the remaining part J found at the top of part D.

Tighten all bolts left loose throughout assembly process.

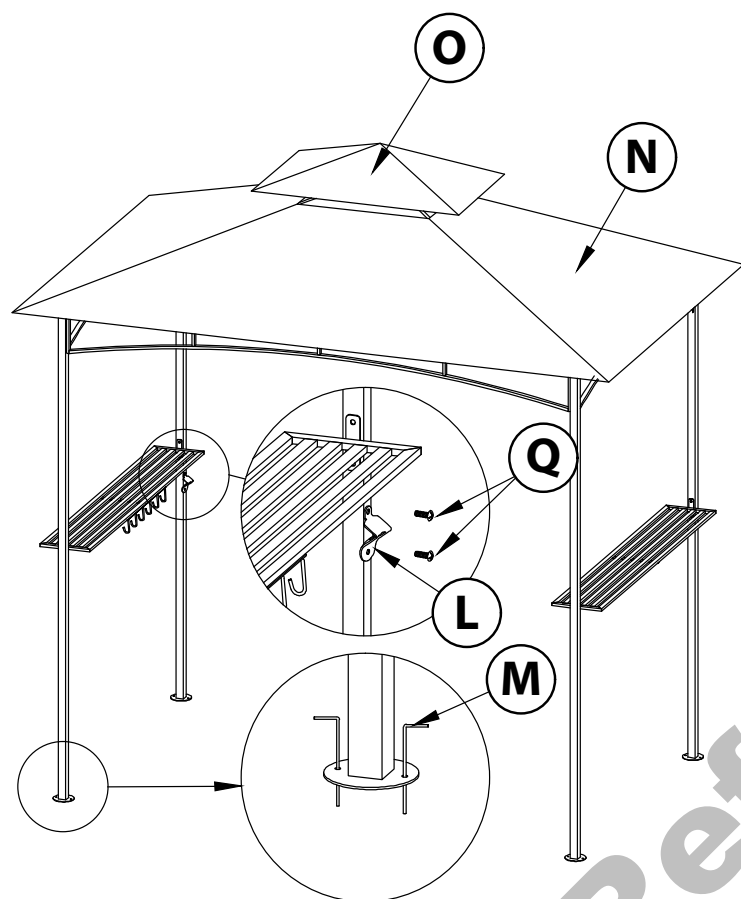

### Step 6:

Insert two M6x15 White Zinc Bolts (Q) through eyelets on the Bottle Opener (L), and into the bolt-threading inserts near the center of Pole (A).

Place Small Canopy (O) over upper ribs of Two-Tier Ribs (G) so that pockets underneath the canopy fit into the rib ends.

Place Main Canopy (N) over lower ribs of Two-Tier Ribs (G), and Canopy Ribs (H) so that pockets underneath the canopy fit into those rib ends.

Run two Stakes (M) through designated eyelets at the bottom of each Pole (A, B, C), and into the ground for extra stability.

## LIMITED WARRANTY

Please contact our service hotline by phone, email, or fax when needing assistance with assembly or with faulty parts. This allows us to provide support in the event of possible operator errors.

All furniture manufactured and sold by TDC USA, Inc. is warranted to the original purchaser against defects in workmanship and materials. If a product manufactured by TDC fails during the first year from date of purchase under the terms of our limited warranty, TDC will replace the item at no charge. After one year, it will be the original purchaser's responsibility to pay for freight and packing. TDC reserves the right, in the case of discontinued or out of production models, to replace with an item of similar quality. (Glass breakage is not warranted.)

**NOTE: You must retain original receipt to obtain warranty!**

### FRAMES:

Frames are warranted against defects in materials and workmanship from the date of original purchase. Damage to frames or welds due to commercial use, improper assembly, exposure to water and sub-freezing temperatures, and/or abuse are not covered.

### FABRIC:

Fabric on cushions, slings, and umbrellas is warranted against separation at the seams. Fading, mildew, and/or discoloration due to exposure to elements, chemicals, and spills are not covered.

### POWDER COAT AND/OR PAINT:

The finish is warranted against blistering, peeling, or cracking. Fading resulting from exposure to the elements, chemicals, and spills are not covered. Scratches and chips due to normal wear and use are not covered.

### FREIGHT & PACKING:

TDC will be responsible for shipping, handling, and packaging charges for all valid warranty claims.

### CARE & MAINTENANCE:

Be careful to never allow water build up in frames as this will cause corrosion and freeze damage in cold climates. Wash all frames with a solution of mild soap and water. Rinse with clean water and dry with a soft absorbent cloth towel. Frames can be treated with a liquid wax for maximum protection against UV rays and/or salty damp air. If your set includes cushions, slings, and/or an umbrella, they may be cleaned by hand with a solution of soap and water with a clean water rinse.

## LIMITED WARRANTY EXCLUSIONS:

- Damage caused by acts of nature
- Wind damage
- Failure caused by unreasonable, unanticipated, or abusive use
- Failure caused by a lack of reasonable and necessary care and maintenance
- Normal fade of fabrics, upholstery, or woven materials
- Glass table tops
- Bursting or cracking of tubing due to exposure to water and freezing temperatures
- Changes in wood color due to the natural aging of the wood

***A sales receipt must be provided to validate the  
1-Year Limited Warranty.***

### **Customer Service:**

**Monday - Friday • 9:00 am - 5:00 pm**

**Phone: 800-599-8898**

**Email: [support@tdcusainc.com](mailto:support@tdcusainc.com)**

**TDC USA, Inc.  
5 Industrial Rd, STE 1  
Fairfield, NJ 07004-3017**

# Grill Gazebo

## Steel Frame with Powder Coating

Dist. by TDC USA, Inc. Fairfield, NJ 07004  
©2023 All Rights Reserved. Made in China.  
Item #21581

**Questions and Comments**  
**1-800-599-8898 (9 am - 5 pm EST)**  
**[www.tdcusainc.com](http://www.tdcusainc.com)**