

Grill Gazebo

Steel Frame with Powder Coating



INSTRUCTIONS

<i>Parts</i>	<i>3</i>
<i>Assembly</i>	<i>4-9</i>
<i>Warranty</i>	<i>10-11</i>

Distributed By T.D.C. USA INC.

Fairfield, NJ 07004

©2016 All Rights Reserved. Made in China

?/Comments: 1-800-599-8898 9am-5pm EST

www.tdcusainc.com

Customer Service

1-800-599-8898

Getting Started

Identify all parts packaged in carton against the parts list. Remove all protective materials and place parts on a non-abrasive surface to avoid scratching. If any parts are missing or damaged, DO NOT attempt to assemble. Please contact our customer service center (Monday-Friday 9:00am – 5:00pm EST) at 1-800-599-8898 or email: support@tdcusainc.com.

Caution: Read all the instructions before assembly. Failure to do so may result in faulty assembly and potential injury! Assemble product on a soft, non-abrasive surface such as a carpet or cardboard to avoid damaging the item. Seek assistance to assemble bulky or heavy items. After final alignment, make sure all bolts and nuts are securely tightened with screw covers pressed in place.

Freight & Packing:

TDC will be responsible for shipping, handling, and packaging charges for all valid warranty claims.

Care & Maintenance:

Be careful to never allow water build up in frames as this will cause corrosion and freeze damage in cold climates. Wash all frames with a solution of mild soap and water. Rinse with clean water and dry with a soft absorbent cloth towel. Frames can be treated with a liquid wax for maximum protection against UV rays and/or salty damp air. If your set includes cushions, slings, and/or an umbrella, they may be cleaned by hand with a solution of soap and water with a clean water rinse.

EXCLUSION:

- Damage caused by acts of nature
- Wind damage
- Failure caused by unreasonable, unanticipated or abusive use
- Failure caused by a lack of reasonable and necessary care and maintenance
- Normal fade of fabrics, upholstery or woven materials
- Glass table tops
- Bursting or cracking of tubing due to exposure to water and freezing temperatures
- Changes in wood color due to the natural aging of the wood

Lack of original receipt will void warranty.

Customer Service: Monday-Friday 9:00am-5:00pm EST

By Phone: 800-599-8898

By E-mail: support@tdcusainc.com

LIMITED WARRANTY

Please contact our service hotline by phone, email or fax before sending the device. This allows us to provide support in the event of possible operator errors.

All furniture manufactured and sold by TDC USA, Inc. is warranted to the original purchaser against defects in workmanship and materials. If a product manufactured by TDC fails during the first year from date of purchase under the terms of our limited warranty, TDC will replace the item at no charge. After one year, it will be the original purchasers' responsibility to pay for freight and packing. TDC reserves the right, in the case of discontinued or out of production models, to replace with an item of similar quality. (Glass breakage is not warranted.)

Note: You must retain original receipt to obtain warranty!

Frames:

Frames are warranted against defects in materials and workmanship from the date of original purchase. Damage to frames or welds due to commercial use, improper assembly, exposure to water and sub-freezing temperatures, and/or abuse are not covered.

Fabric:

Fabric on cushions, slings, and umbrellas is warranted against separation at the seams. Fading, mildew, and/or discoloration due to exposure to elements, chemicals, and spills are not covered.





















Powder coat and/or Paint:

The finish is warranted against blistering, peeling, or cracking. Fading resulting from exposure to elements, chemicals, and spills are not covered. Scratches and chips due to normal wear and use are not covered.

Umbrella:

Umbrella frames are warranted against manufacturer's defects in workmanship and materials.

Safety Warning! Umbrellas must be closed when not in use and taken down in windy conditions.

A	Pole		1 pcs
B	Pole		1 pcs
C	Pole		2 pcs
D	Long Arch		2 pcs
E	Small Arch		2 pcs
F	Shelf		2 pcs
G	Two Tier Ribs		4 pcs
H	Canopy Ribs		2 pcs
I	Connector		1 pcs
J	Rib Brace		6 pcs
K	Utensil Rack		1 pcs
L	Bottle Opener		1 pcs
M	Stake		8 pcs
N	Main Canopy		1 pcs
O	Small Canopy		1 pcs
P	Screw M6x10		9 pcs
Q	White Zinc Screw M6x15		2 pcs
R	Black Zinc Screw M6x15		8 pcs
S	Screw M6x20		16 pcs
T	Screw M6x28		6 pcs
U	Nut		6 pcs

Do not tighten the screws until all screws are in place.

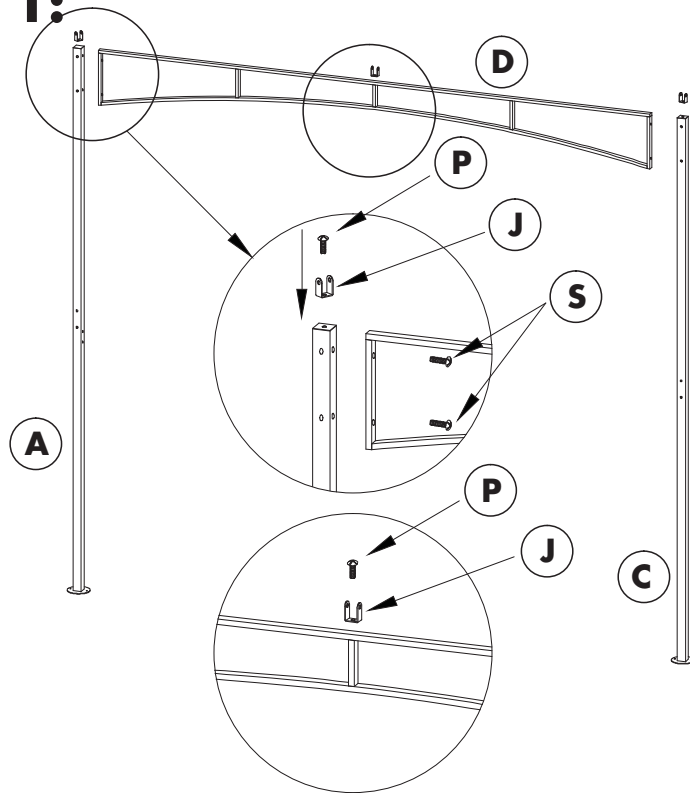
Step 1:

Insert Screw M6x10 (P) through Rib Brace (J) and into the top of Pole (A). Follow this same step with Pole (B) and both of Pole (C).

Insert Screw M6x10 (P) through Rib Brace (J) and into the top-center of Long Arch (D). Follow this same step with the second Long Arch (D). Insert two Screw M6x20 (S) through one end of Long Arch (D) and into upper portion of Pole (A). Follow this step to connect the opposite end of Long Arch (D) to Pole (C). Follow these same steps to assemble Pole (B) with the second Long Arch (D) and Pole (C).

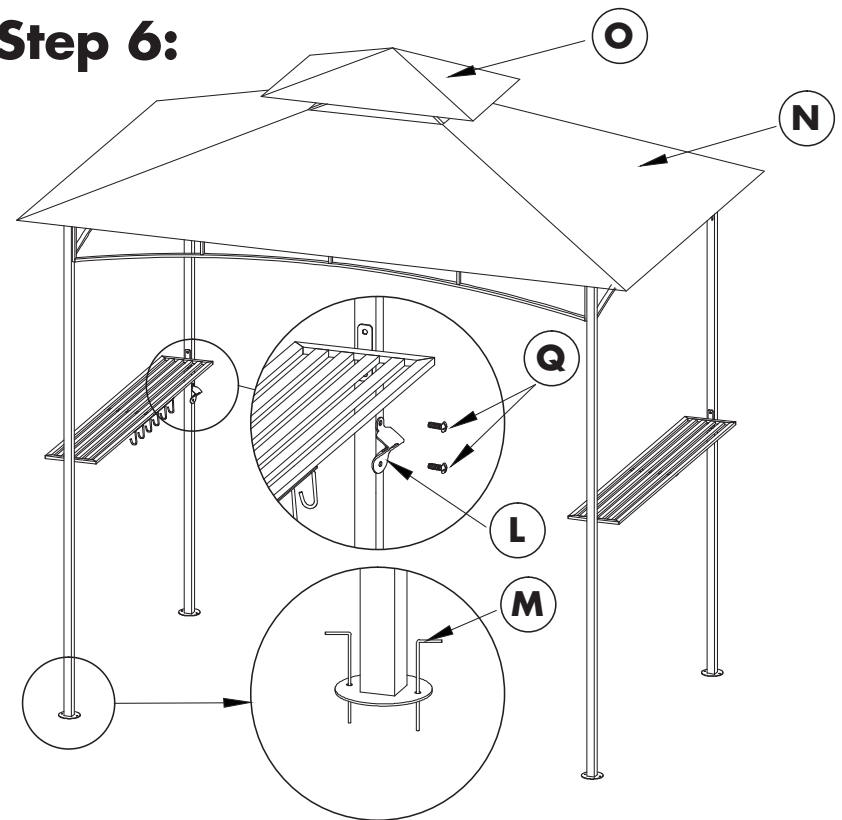
Step 6:

Insert two White Zinc Screws M6x15 (Q) through Bottle Opener (L) and into designated holes in Pole (A).

Place Small Canopy (O) over upper bar of Two Tier Ribs (G) so that pockets underneath canopy fit into rib ends.

Place Main Canopy (N) over lower bar of Two Tier Ribs (G) and Canopy Ribs (H).

Run two Stakes (M) through designated holes at bottom of Poles (A, B, C) and into the ground for extra stability.

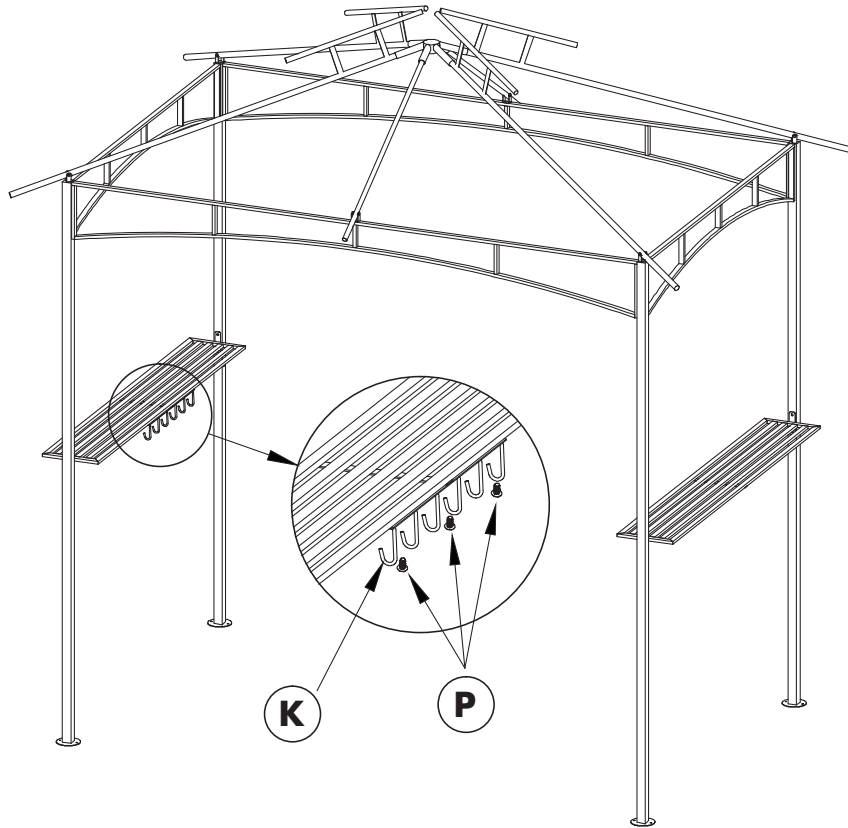
Step 5:

Insert three Screws M6x10 (P) through Utensil Rack (K) and into screw holes underneath Shelf (F).

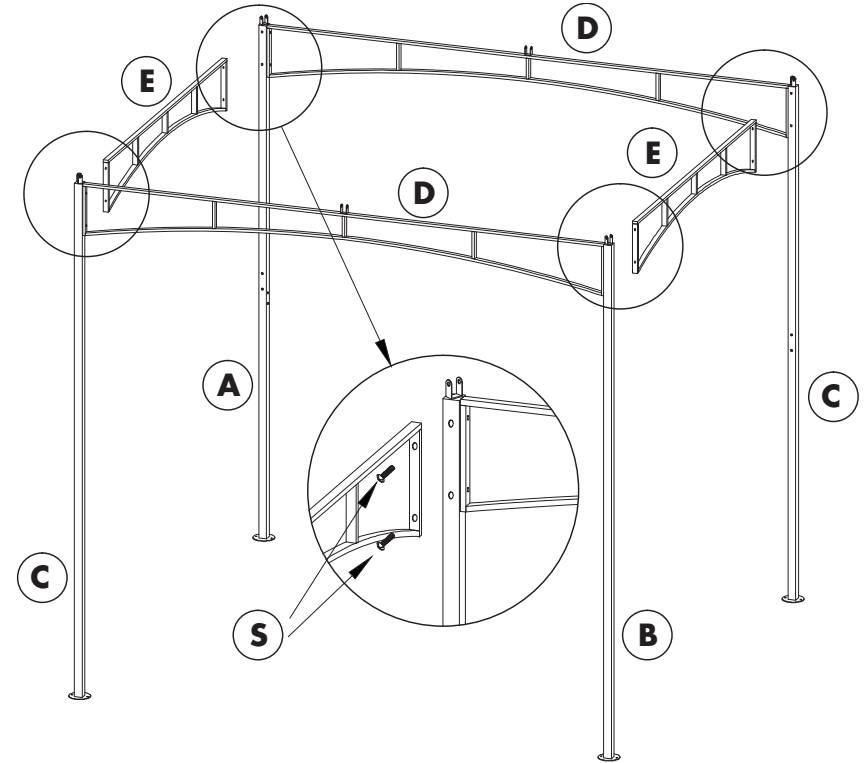
Step 2:

Insert two Screw M6x20 (S) through one end of Small Arch (E) and into upper portion of Pole (A). Follow this step to connect opposite end of Small Arch (E) to Pole (C). Follow these same steps to assemble Pole (B) with the second Small Arch (E) and Pole (C). When complete, both Poles (C) should be diagonal from one another and Pole (A) and Pole (B) should be diagonal.

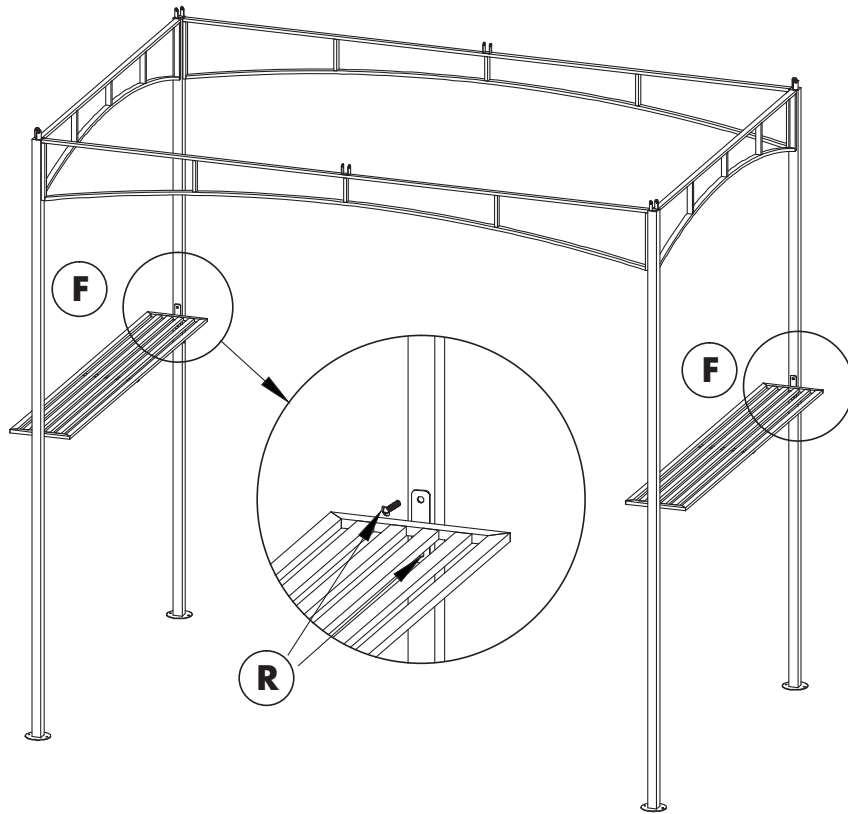
Step 3:

Insert two Screws M6x15 (R) through upper and lower screw holes of one end of Shelf (F) and into mid-portion of Pole (A). Follow this step to connect opposite end of Shelf (F) to Pole (C). Follow these same steps to assemble Pole (B) with the second Shelf (F) and Pole (C).

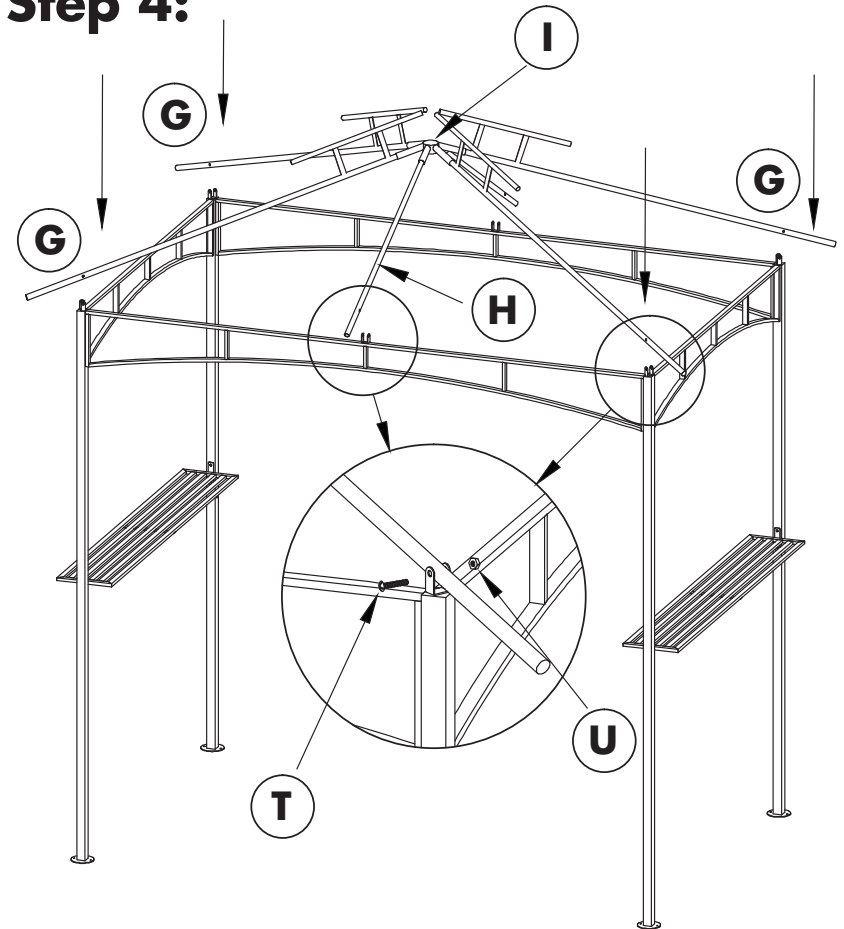
Step 4:

Insert Two Tier Ribs (G) into the four longer tubes of Connector (I). Insert Canopy Ribs (H) into two shorter tubes of Connector (I). Place assembled ribs with connector over the height of assembled frame. Place exposed ends of Two Tier Ribs (G) and Canopy Ribs (H) in between Rib Braces (J). Insert Screws M6x28 (T) through Rib Braces (J) and through both rib types; tighten down using Nut (U). Tighten all screws that have been left loose throughout the building process.