

User Manual

Manual del usuario

GARDENLINE®

BIRD FEEDER STATION

ESTACIÓN DE ALIMENTACIÓN PARA PÁJAROS



English.... Page 3
Español.... Página 13

Contents • Contenido

Getting Started	3
Pack Contents/Parts	4
Parts List	5
Hardware List	6
Assembly Instructions	7

Para comenzar	13
Contenido del paquete/piezas	14
Lista de piezas	15
Lista de hardware.....	16
Instrucciones de ensamblaje	17

Getting Started

Ensure all parts packaged in carton match the parts list. If any parts are missing or damaged, please contact our customer service center (Monday-Friday 9:00am – 5:00pm EST) at 1-800-599-8898.

Caution

Read all the instructions before getting started. Failure to comply with instructions may result in faulty assembly and potential injury!

Pack contents / parts

- A** End Pole
- B** Center Pole
- C** Double Hook Bracket
- D** Obelisk
- E** Single Hook
- F** Water Bowl Bracket
- G** Water Bowl
- H** Suet Cage

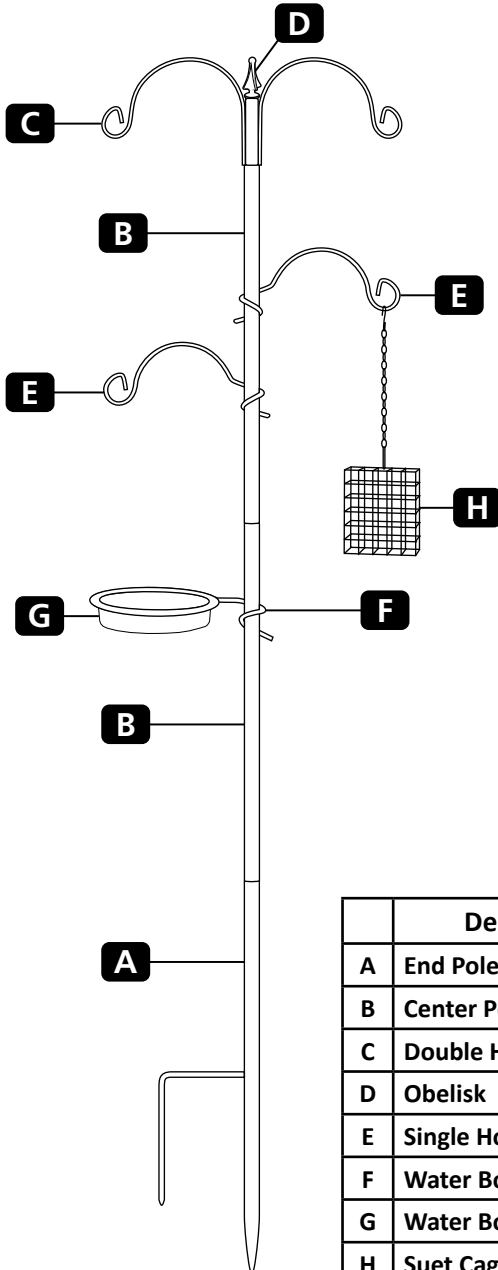

	Description	Qty
A	End Pole	1
B	Center Pole	2
C	Double Hook Bracket	1
D	Obelisk	1
E	Single Hook	2
F	Water Bowl Bracket	1
G	Water Bowl	1
H	Suet Cage	1

A

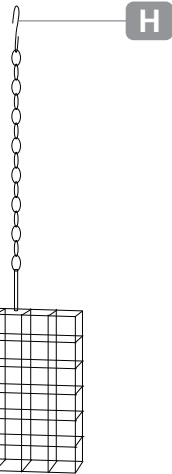
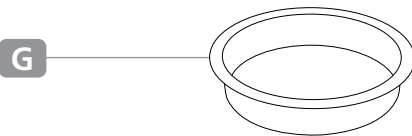
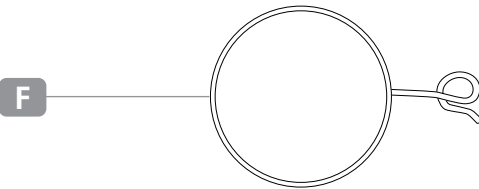
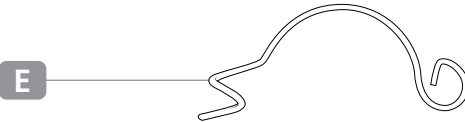
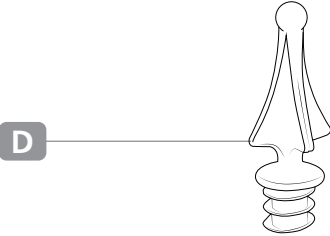
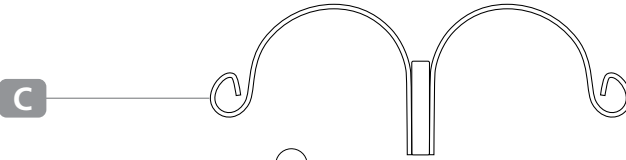
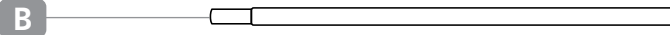
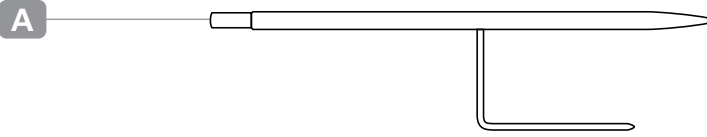

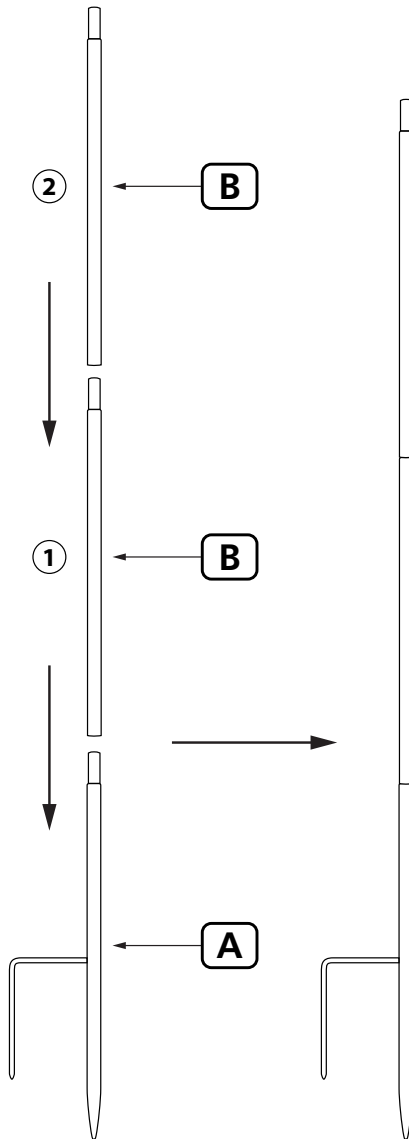

Connect one Center Pole (B) to the End Pole (A). Then connect the second Center Pole (B) to the first Center Pole (B).

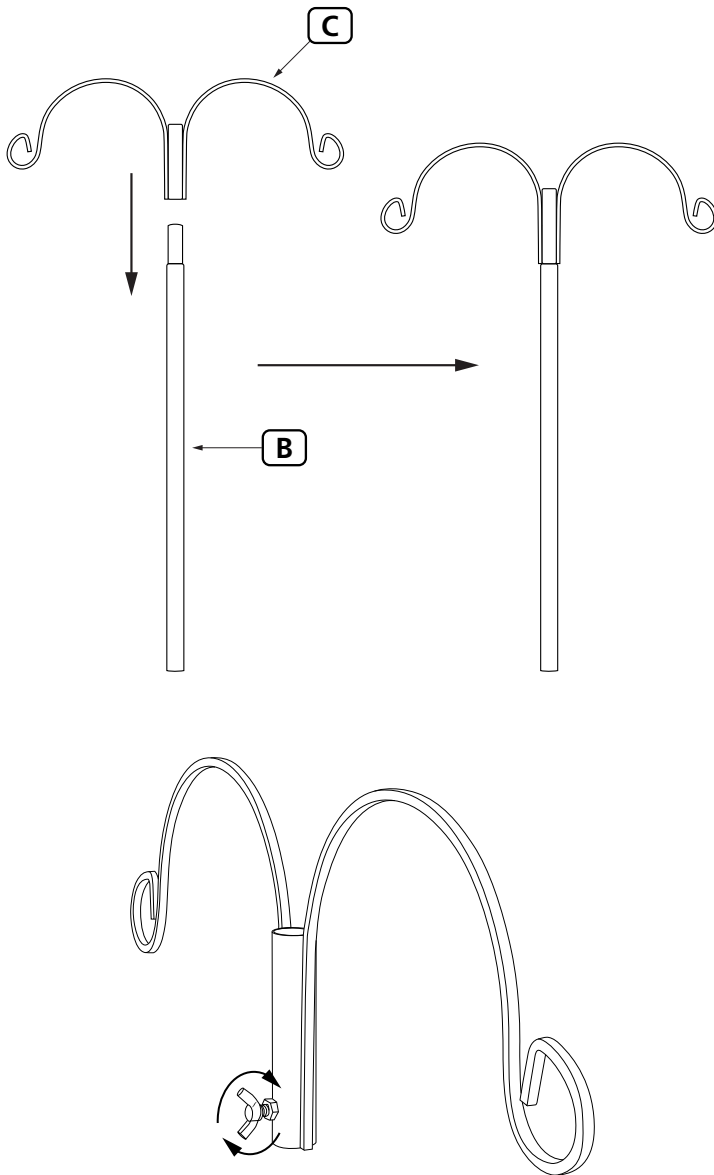

Place the Double Hook Bracket (C) to the top of the Center Pole (B). Then tighten the wingnut to secure the Double Hook Bracket (C) to the Center Pole (B).

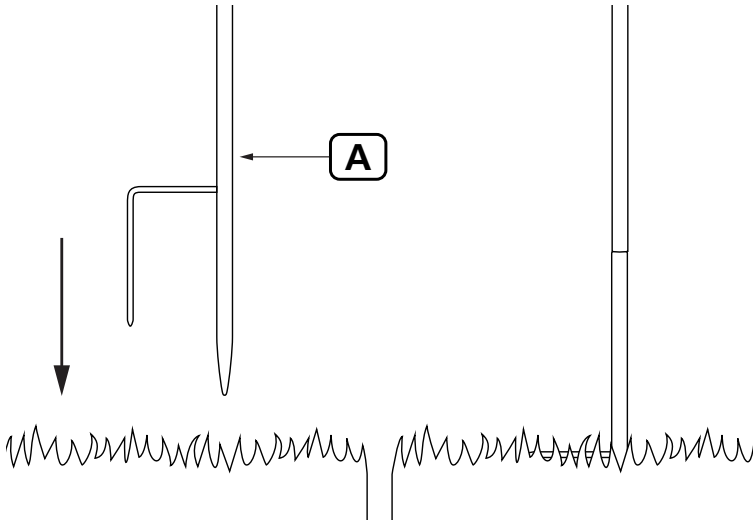
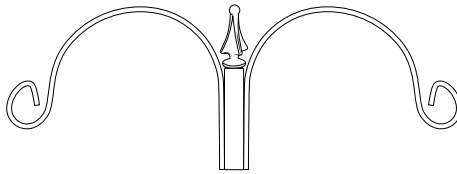
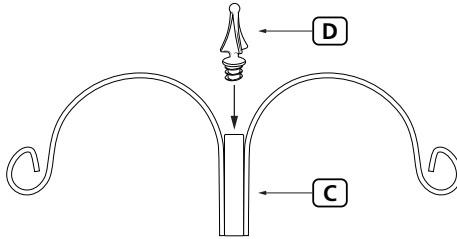

Push Obelisk (D) in the Double Hook Bracket (C).

Insert pointed end of the End Pole (A) into the ground and make sure it is stable and sturdy.

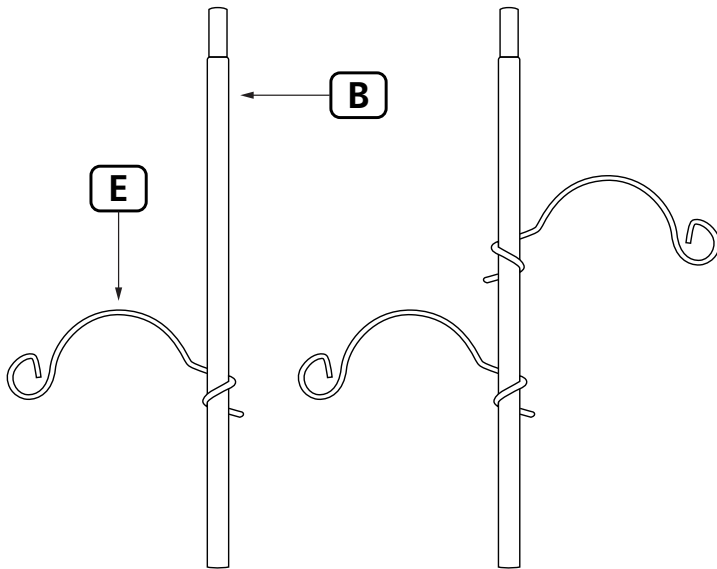
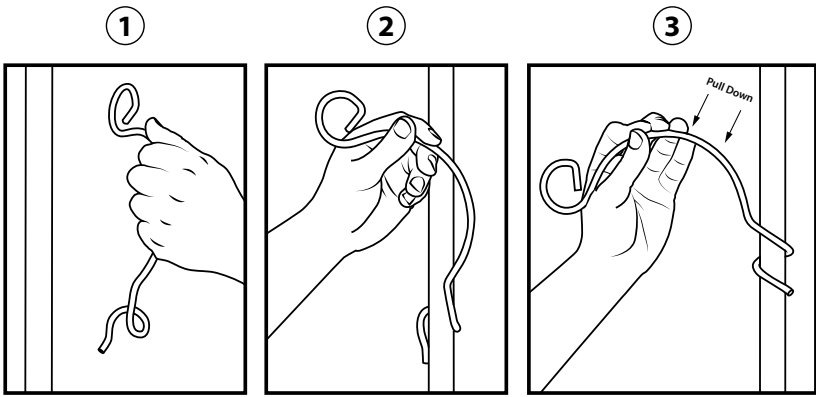

Add two Single Hooks (E) to the body (see above illustration), the location of the hooks can be adjusted according to what product you will be hanging.

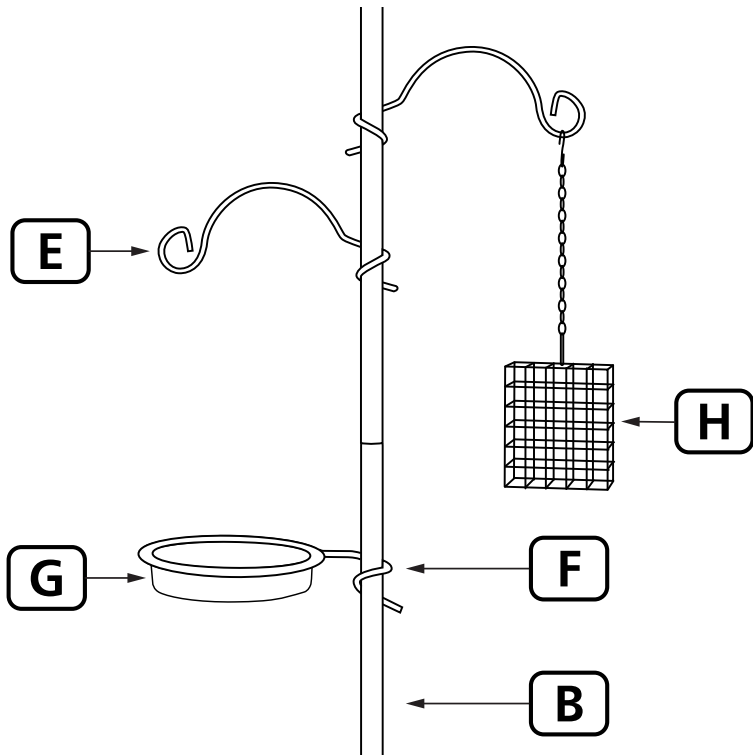

Add Water Bowl Bracket (F) to the body (in the same manner as the Single Hooks (E)), then place the Water Bowl (G) in bracket. Add the Suet Cage (H) to a Single Hook (E). The station is ready to use.

Para comenzar

Asegúrese que todas las piezas incluidas en la caja coincidan con la lista de piezas. Si alguna pieza falta o está dañada, llame al Servicio de Atención al Cliente (lunes a viernes, de 9:00 a.m. a 5:00 p.m., EST) al 1- 800-599-8898.

Precaución

Lea todas las instrucciones antes de comenzar. ¡No cumplir con las instrucciones puede causar un ensamblaje defectuoso y la posibilidad de sufrir lesiones!

Contenido del paquete/piezas

- A** Poste del extremo
- B** Poste central
- C** Soporte del gancho doble
- D** Obelisco
- E** Gancho simple
- F** Soporte del recipiente de agua
- G** Recipiente de agua
- H** Jaula del sebo

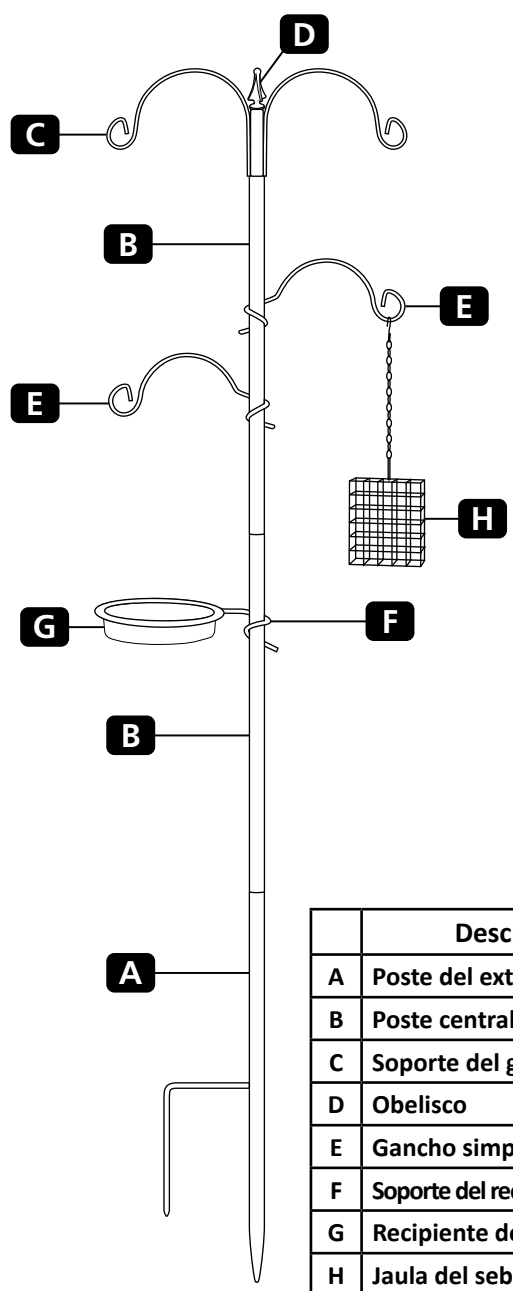

	Descripción	Cantidad
A	Poste del extremo	1
B	Poste central	2
C	Soporte del gancho doble	1
D	Obelisco	1
E	Gancho simple	2
F	Soporte del recipiente de agua	1
G	Recipiente de agua	1
H	Jaula del sebo	1

A

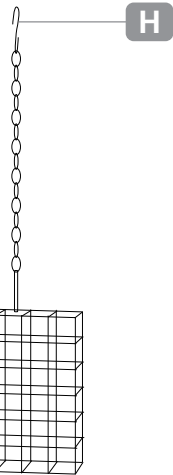
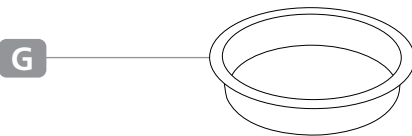
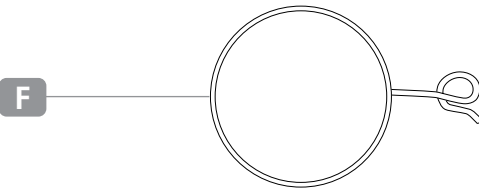
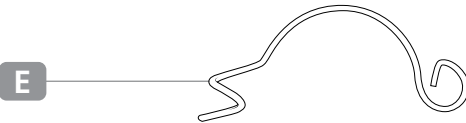
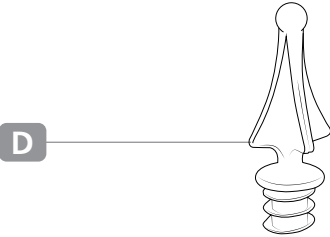
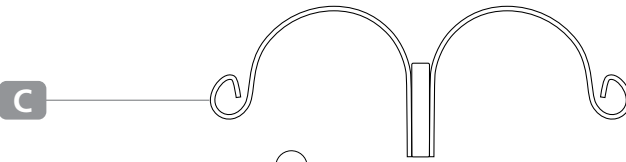
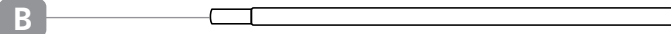
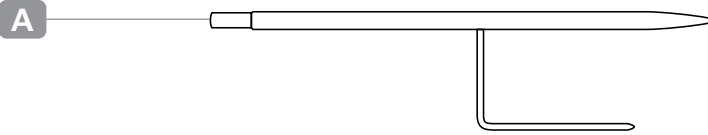

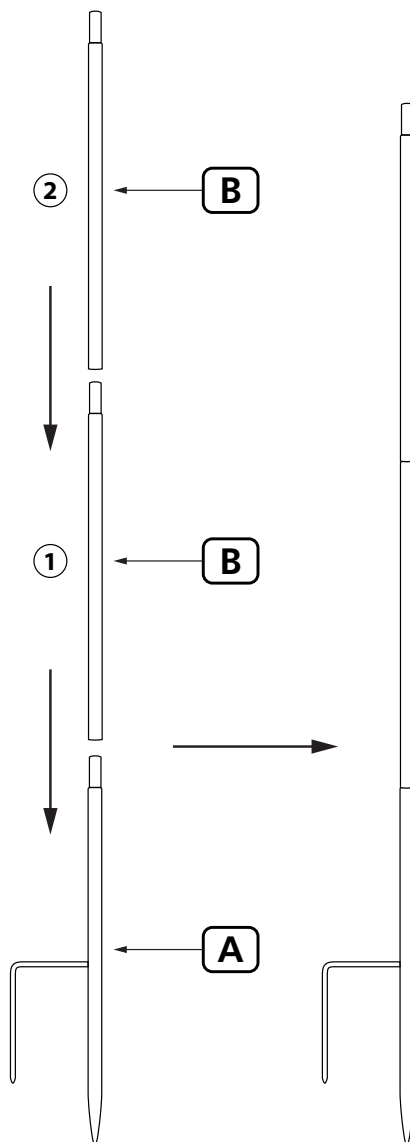

Conecte un poste central (B) al poste del extremo (A). Luego conecte el segundo poste central (B) al primer poste central (B).

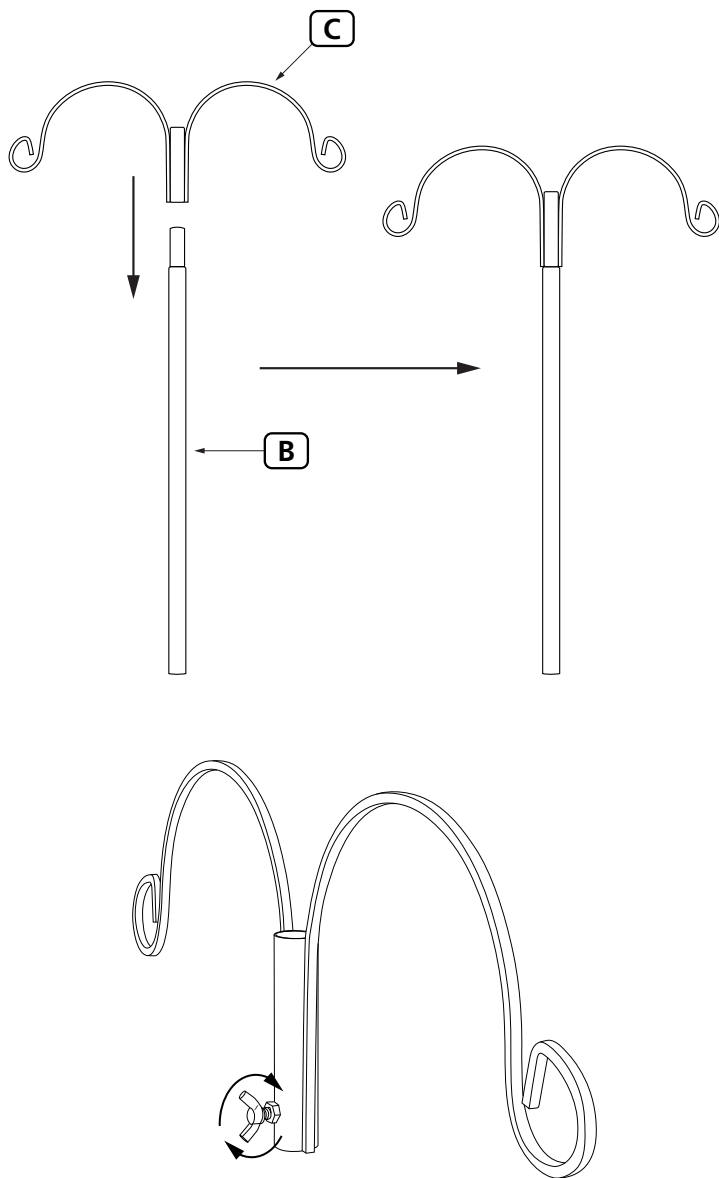

Coloque el soporte del gancho doble (C) en la parte superior del poste central (B). Luego ajuste la tuerca mariposa para fijar el soporte del gancho doble (C) al poste central (B).

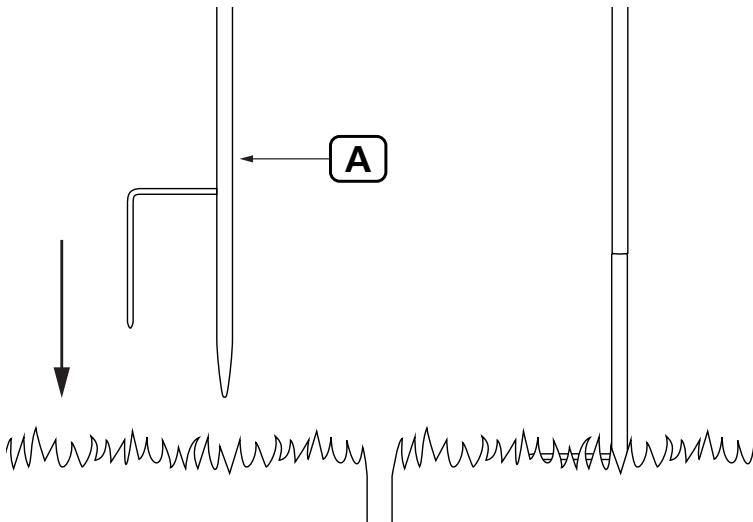
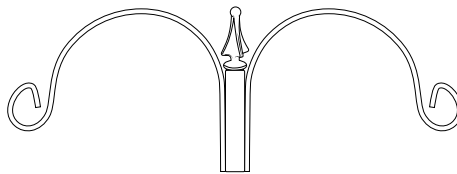
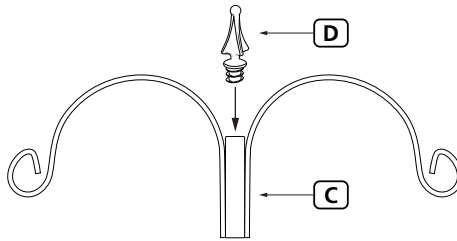

Empuje el obelisco (D) contra el soporte del gancho doble (C).

Inserte el extremo puntiagudo del poste del extremo (A) en el suelo y asegúrese de que quede estable y firme.

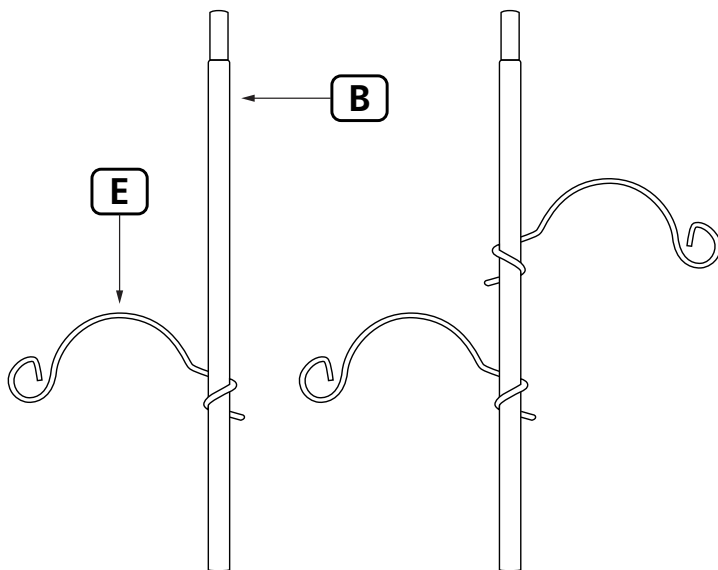
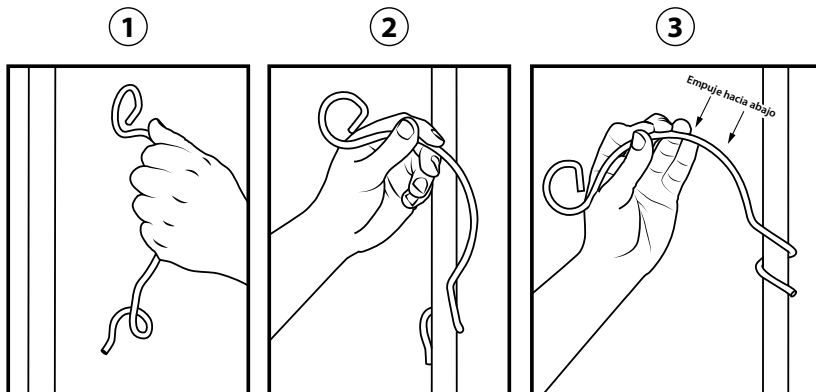

Agregue dos ganchos simples (E) al cuerpo (ver ilustración anterior); la ubicación de los ganchos se puede ajustar en función del producto que vaya a colgar.

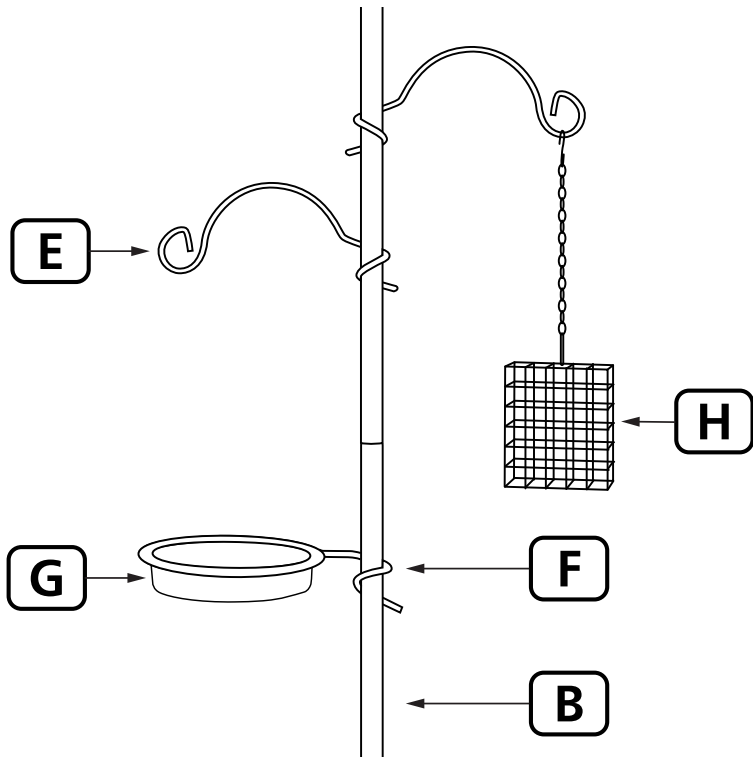

Agregue el soporte del recipiente de agua (F) al cuerpo (de la misma manera que los ganchos simples (E)) y luego coloque el recipiente de agua (G) en el soporte. Coloque la jaula del sebo (H) en un gancho simple (E). La estación está lista para su uso.

**DIST. & SOLD EXCLUSIVELY BY:
ALDI
BATAVIA, IL 60510**