

9 Piece Patio Set

Steel Frame with Powder Coating



INSTRUCTIONS

<i>Rectangle Table Parts</i>	3
<i>Rectangle Table Assembly</i>	4-6
<i>Side Table Parts</i>	7
<i>Side Table Assembly</i>	8-9
<i>Warranty</i>	10-11

Customer Service





1-800-599-8898

Getting Started

Identify all parts packaged in carton against the parts list. Remove all protective materials and place parts on a non-abrasive surface to avoid scratching. If any parts are missing or damaged, DO NOT attempt to assemble. Please contact our customer service center (Monday-Friday 9:00am – 5:00pm EST) at 1-800-599-8898 or email: support@tdcusainc.com.

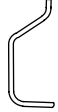
Caution: Read all the instructions before assembly. Failure to do so may result in faulty assembly and potential injury! Assemble product on a soft, non-abrasive surface such as a carpet or cardboard to avoid damaging the item. Seek assistance to assemble bulky or heavy items. After final alignment, make sure all bolts and nuts are securely tightened with screw covers pressed in place.

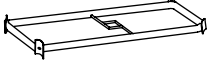
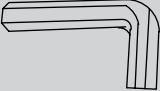
Rectangular Table Parts

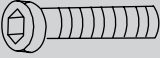
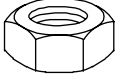
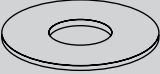
A	Table Top		1
B	Leg		4
C	Leg Brace		1
D	Leg Brace with Umbrella Hole		1
E	Hex Key		1
E1	Wrench		1
F	M6 * 52 Screw		8
G	Nut		8
H	Washer		8

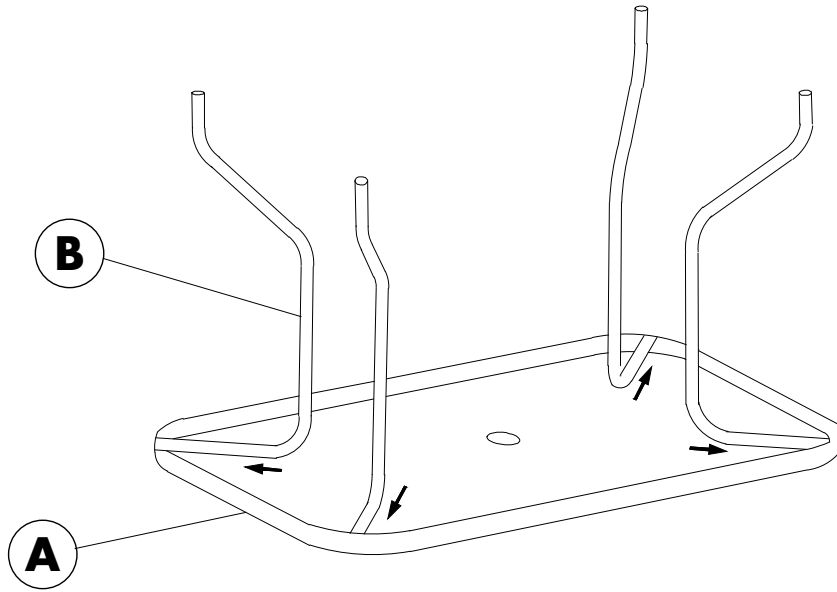
Step 1:

Carefully lay Table Top (A) upside down on the ground. Insert oval-shaped end of Leg (B) inside oval-shaped insert inside rim of Table Top (A). Do this with all four legs.

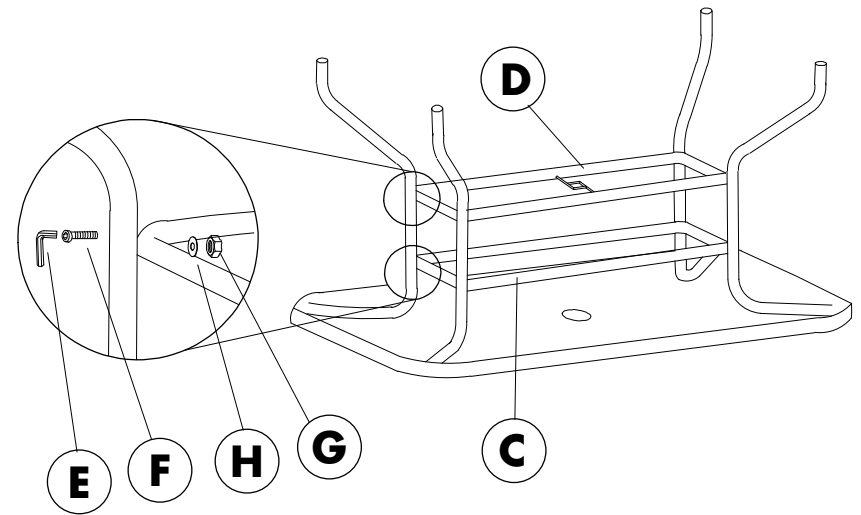
Step 2:

Place Screw M6x52 (F) through Leg (B) and into Leg Brace (C) and then through Washer (H) and Nut (G). Do not tighten the screws. Do this for the other 3 Legs (B).

Repeat for Leg Brace with Umbrella Hole (D).

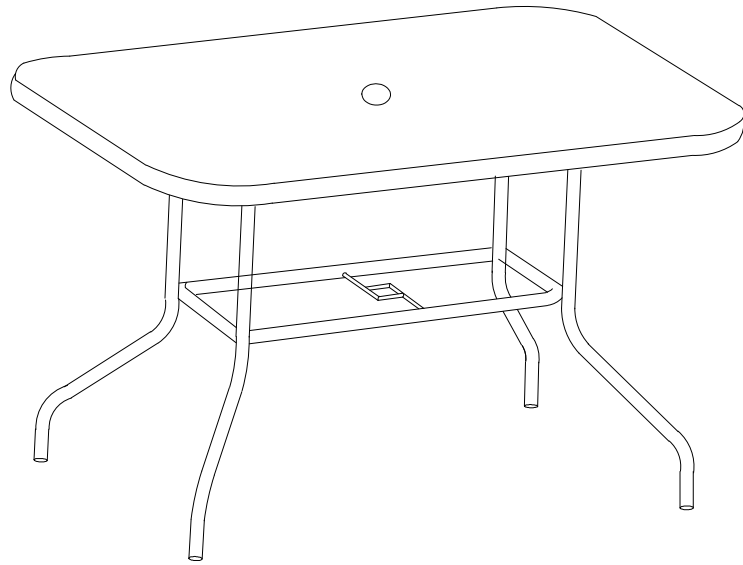

Tighten all screws.

Step 3:

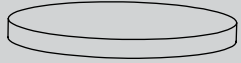

Carefully turn assembled table right side up.

Side Table Parts

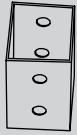
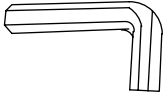
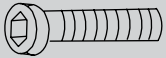
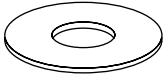
A	Side Table Top		1
B	Leg		4
C	Leg Brace		1
D	Hex Key		1
E	M6 * 35 Screw		1
F	Washer		8

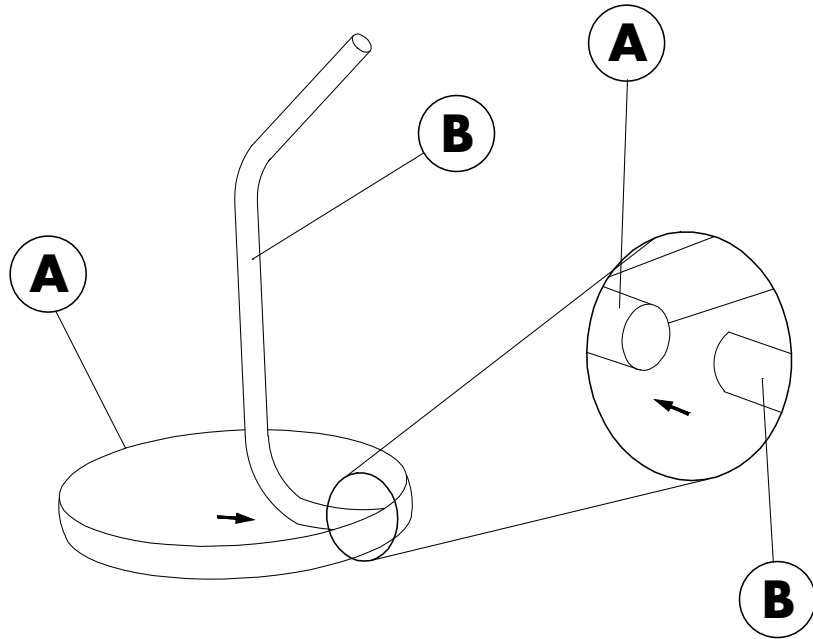
Step 1:

Carefully lay Side Table Top (A) upside down on the ground. Insert oval-shaped end of Leg (B) inside oval-shaped insert inside rim of Side Table Top (A). Do this with all four legs.

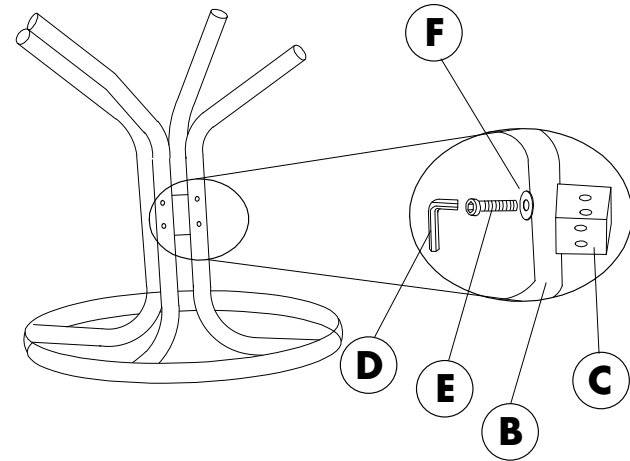
Step 2:

Insert eight Screws M6x35 (E) through Washers (F), then holes of Legs (B) and into Leg Brace (C).

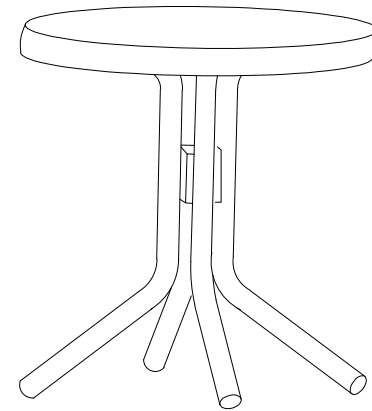
Step 3:

Carefully turn assembled table right side up.

LIMITED WARRANTY

Please contact our service hotline by phone, email or fax before sending the device. This allows us to provide support in the event of possible operator errors.

All furniture manufactured and sold by TDC USA, Inc. is warranted to the original purchaser against defects in workmanship and materials. If a product manufactured by TDC fails during the first year from date of purchase under the terms of our limited warranty, TDC will replace the item at no charge. After one year, it will be the original purchasers' responsibility to pay for freight and packing. TDC reserves the right, in the case of discontinued or out of production models, to replace with an item of similar quality. (Glass breakage is not warranted.)

Note: You must retain original receipt to obtain warranty!

Frames:

Frames are warranted against defects in materials and workmanship from the date of original purchase. Damage to frames or welds due to commercial use, improper assembly, exposure to water and sub-freezing temperatures, and/or abuse are not covered.

Fabric:

Fabric on cushions, slings, and umbrellas is warranted against separation at the seams. Fading, mildew, and/or discoloration due to exposure to elements, chemicals, and spills are not covered.

Powder coat and/or Paint:

The finish is warranted against blistering, peeling, or cracking. Fading resulting from exposure to elements, chemicals, and spills are not covered. Scratches and chips due to normal wear and use are not covered.

Umbrella:

Umbrella frames are warranted against manufacturer's defects in workmanship and materials.

Safety Warning! Umbrellas must be closed when not in use and taken down in windy conditions.

Freight & Packing:

TDC will be responsible for shipping, handling, and packaging charges for all valid warranty claims.

Care & Maintenance:

Be careful to never allow water build up in frames as this will cause corrosion and freeze damage in cold climates. Wash all frames with a solution of mild soap and water. Rinse with clean water and dry with a soft absorbent cloth towel. Frames can be treated with a liquid wax for maximum protection against UV rays and/or salty damp air. If your set includes cushions, slings, and/or an umbrella, they may be cleaned by hand with a solution of soap and water with a clean water rinse.

EXCLUSION:

- Damage caused by acts of nature
- Wind damage
- Failure caused by unreasonable, unanticipated or abusive use
- Failure caused by a lack of reasonable and necessary care and maintenance
- Normal fade of fabrics, upholstery or woven materials
- Glass table tops
- Bursting or cracking of tubing due to exposure to water and freezing temperatures
- Changes in wood color due to the natural aging of the wood

Lack of original receipt will void warranty.

Customer Service: Monday-Friday 9:00am-5:00pm EST

By Phone: 800-599-8898

By E-mail: support@tdcusainc.com



Distributed By T.D.C. USA INC.

Fairfield, NJ 07004

©2017 All Rights Reserved. Made in China

?/Comments: 1-800-599-8898 9am-5pm EST

www.tdcusainc.com