

9 Piece Patio Set

Steel Frame with Powder Coating

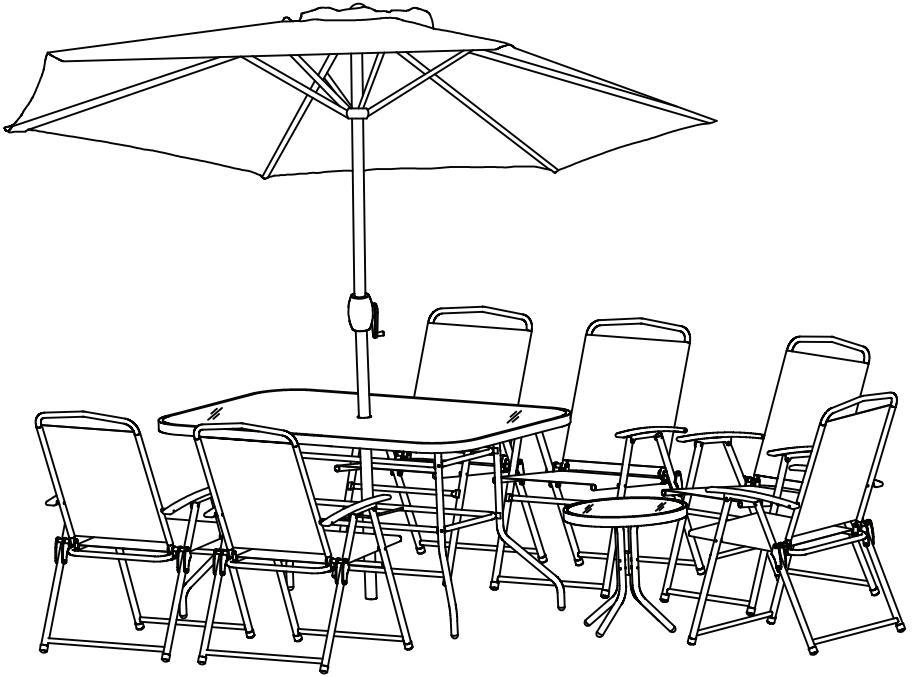

Assembly Instructions

Made in China

The owner's manual contains important safety information as well as assembly, use and maintenance instructions. Keep the packaging and bags away from children and dispose of all packaging properly before use. Keep this manual for future reference.



**PLEASE DO NOT
RETURN THIS
PRODUCT
TO THE STORE**

We will be happy to correct any problems that you may have, or answer any of your questions regarding the purchase of this product. Please contact us at our Toll Free customer service number 1-800-599-8898 for any assistance and replacement parts. Thank You.

Dist. by TDC USA, Inc. Fairfield, NJ 07004

© 2021 All Rights Reserved.

Made in China

Item 21742

www.tdcusainc.com











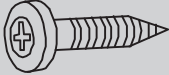

**WARNING!**

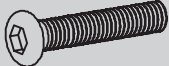
- **Keep all children and pets away from assembly area. Children and pets should be supervised when they are in the area of the product construction.**
- **Some parts may contain sharp edges. When assembling and using this product, basic safety precautions should always be.**
- **Please read all the instructions and warnings before assembling. In order to make the whole product adjust to the best, please install all the screws on the product and tighten all the screws after adjusting the product which can stand on the floor even. Not intended for commercial use.**
- **Check all bolts for tightness before use.**
- **IMPORTANT - check and tighten bolts often to keep them secure**

• **CHOKING HAZARD** - Small parts. Not suitable for children under 36 months. The product contains small parts, keep children away when assembling.

• **ADULT ASSEMBLY REQUIRED.**

Always remove protective material and poly bags and dispose before assembly.

<p>A</p>  <p>Table (x1)</p>	<p>H</p>  <p>Screw (x4)</p>
<p>B</p>  <p>Leg (X4)</p>	<p>I</p>  <p>M6x52 Bolt (X8)</p>
<p>C</p>  <p>Leg Support (x1)</p>	<p>J</p>  <p>M6x40 Bolt (X8)</p>
<p>D</p>  <p>Leg Support (x1)</p>	<p>K</p>  <p>Washer (x8)</p>
<p>E</p>  <p>Side Table (x1)</p>	<p>L</p>  <p>Nut (x8)</p>
<p>F</p>  <p>Side Table Leg (X4)</p>	<p>M</p>  <p>Hex Key (x1)</p>
<p>G</p>  <p>Leg Brace (x1)</p>	<p>N</p>  <p>Wrench (x1)</p>

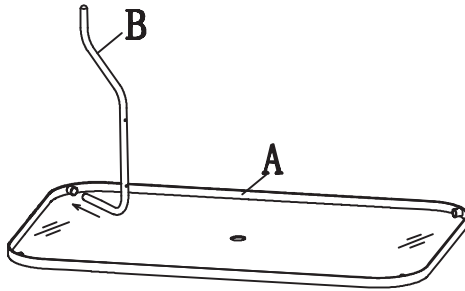

Step 1:

Carefully lay Table (A) upside down on the ground; be mindful of the glass when setting it down. Insert end of Leg (B) into the plastic-insert inside of rim of Table (A). Follow this step to place the remaining Legs (B) at each corner of Table (A).

Fig. 1

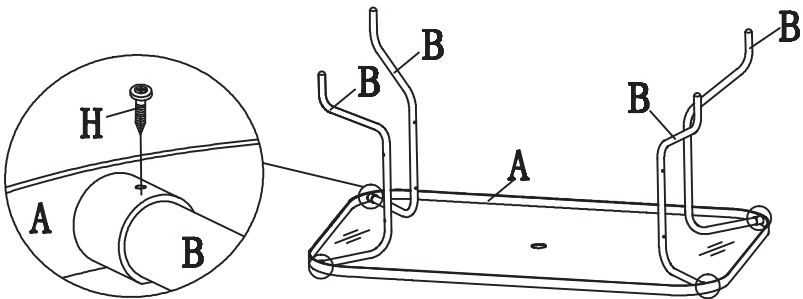

Step 2:

Insert Screws (H) through these plastic-inserts and into the Legs (B); see Figure 1. It is recommended to not tighten screws and bolts completely until all parts have been assembled.

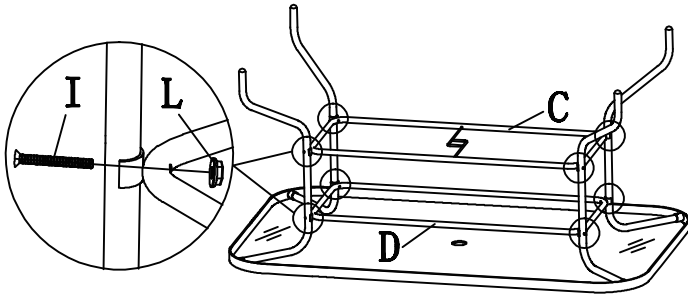
Fig. 2**Step 3:**

Place Leg Support (D) in between the four previously assembled Legs (B). Insert one Bolt M6x52 (I) through the hole of Leg (B) that is nearest to glass of table and through the ring of Leg Support (D); see Figure 2. Use a Nut (L) to hold these parts together; do not overtighten. Follow these steps to secure each corner of Leg Support (D) to each Leg (B). Place Leg Support (C) in between the assembled Legs (B) next. Insert one Bolt M6x52 (I) through the hole of Leg (B) that is furthest from glass of table and through the ring of Leg Support (C); see Figure 2. Use a Nut (L) to hold these parts together; do not overtighten. Follow these steps to secure each corner of Leg Support (C) to each Leg (B).

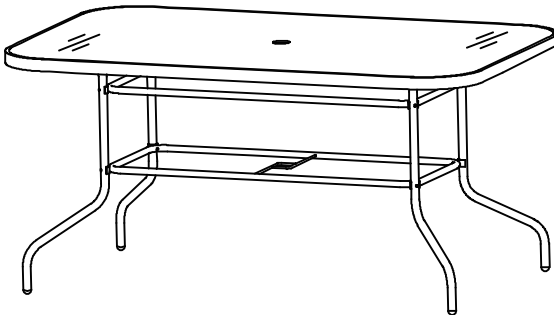
**Step 4:**

Tighten all screws and bolts left loose throughout the assembly process. Carefully turn the table right-side up.

Step 1:

Carefully set Side Table (E) upside down on the ground; be mindful of glass when setting it down. Insert end of Side Table Leg (F) into plastic-insert inside of rim of Side Table (E).

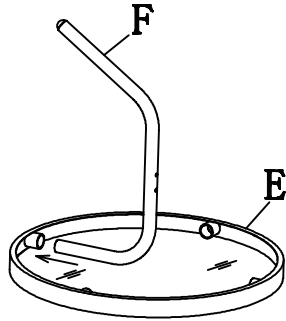
**Step 2:**

Follow Step 1 to place the remaining Side Table Legs (F) into inserts of Side Table (E).

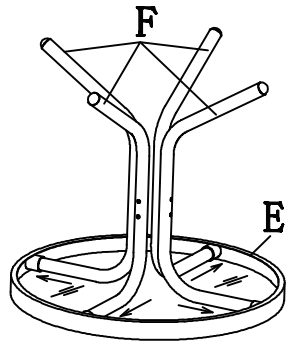
**Step 3:**

Place Leg Brace (G) in between Side Table Legs (F). Insert two Bolts M6x40 (J) with Washers (K) through holes at the center of each Side Table Legs (F) and into the screw-threading found on each side of Leg Brace (G); see Fig.1. It is advised to not tighten bolts all the way until all four Side Table Legs (F) have been secured to Leg Brace (G).

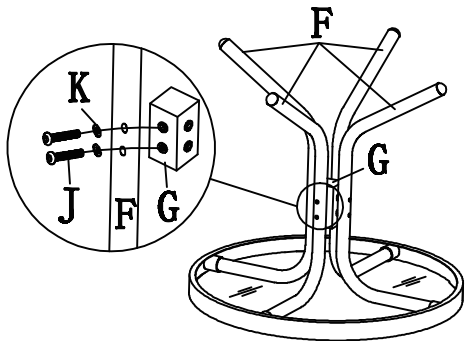
**Step 4:**

Tighten all bolts left loose throughout assemble process. Carefully turn the table right-side up when completed.

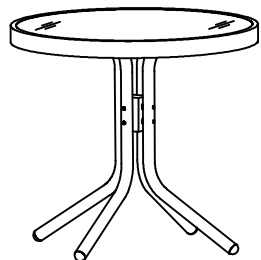

9 Piece Patio Set

Steel Frame with Powder Coating

Dist. by TDC USA, Inc. Fairfield, NJ 07004
©2021 All Rights Reserved. Made in China.
Item #21742

Questions and Comments
1-800-599-8898 (9 am - 5 pm EST)
www.tdcusainc.com