

6 Piece Patio Dining Set

Steel Frame with Powder Coating

Table Assembly



INSTRUCTIONS

<i>Parts</i>	3
<i>Assembly</i>	4-7
<i>Warranty</i>	8-9







Customer Service

1-800-599-8898

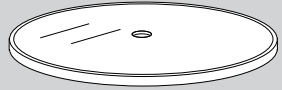
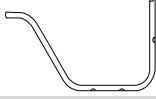
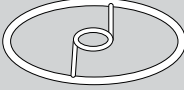
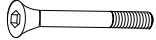
Getting Started

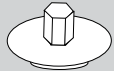
Identify all parts packaged in carton against the parts list. Remove all protective materials and place parts on a non-abrasive surface to avoid scratching. If any parts are missing or damaged, DO NOT attempt to assemble. Please contact our customer service center (Monday-Friday 9:00am – 5:00pm EST) at 1-800-599-8898 or email: support@tdcusainc.com.

Caution: Read all the instructions before assembly. Failure to do so may result in faulty assembly and potential injury! Assemble product on a soft, non-abrasive surface such as a carpet or cardboard to avoid damaging the item. Seek assistance to assemble bulky or heavy items. After final alignment, make sure all bolts and nuts are securely tightened with screw covers pressed in place.

A	Table		1pc
B	Leg		4pcs
C	Leg Ring		2pcs
D	1/4"x55mm Screw		8pc
E	Nut		8pc
F	Spacer		4pcs
G	Cover		8pcs
H	Nut Cover		8pc
I	Table Ring		1pc
J	Hex Key		1pc
K	Wrench		1pc

Do not tighten the screws until all screws are in place.

Step 1:

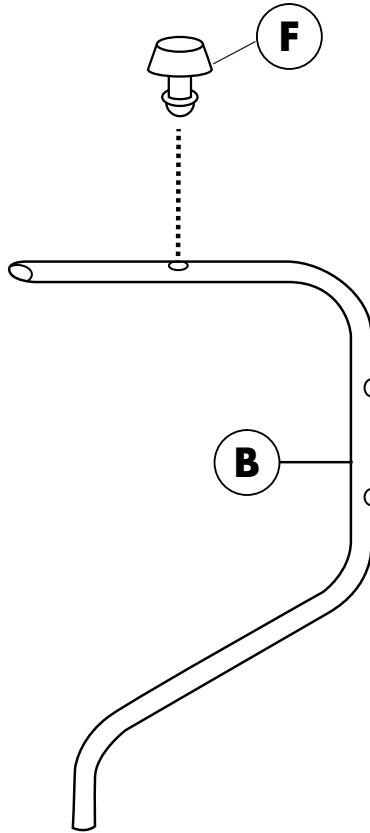

Insert Spacers (F) into the tops of all four Legs (B).

Step 2:

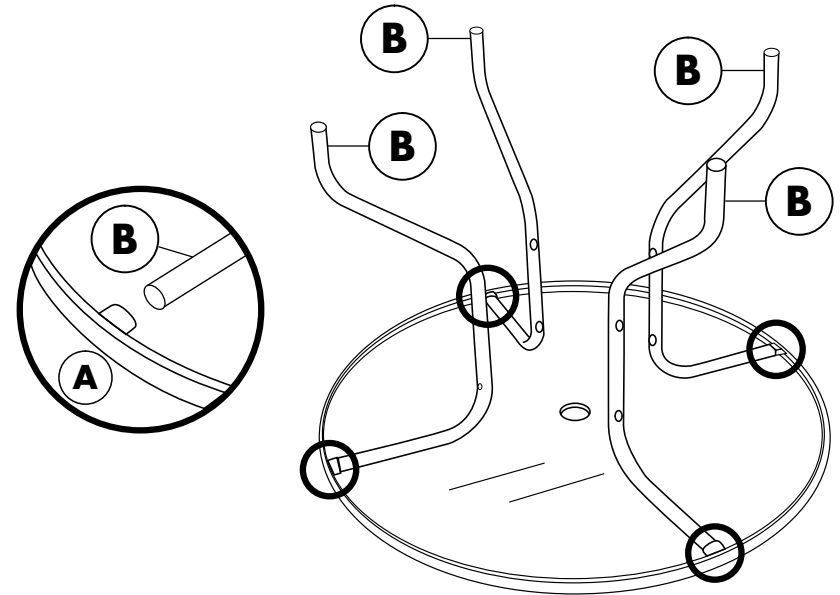

Carefully lay Table (A) upside down on the ground. Insert oval-shaped end of Leg (B) inside oval-shaped insert inside rim of Table (A). Do this with all four legs.

Step 3:

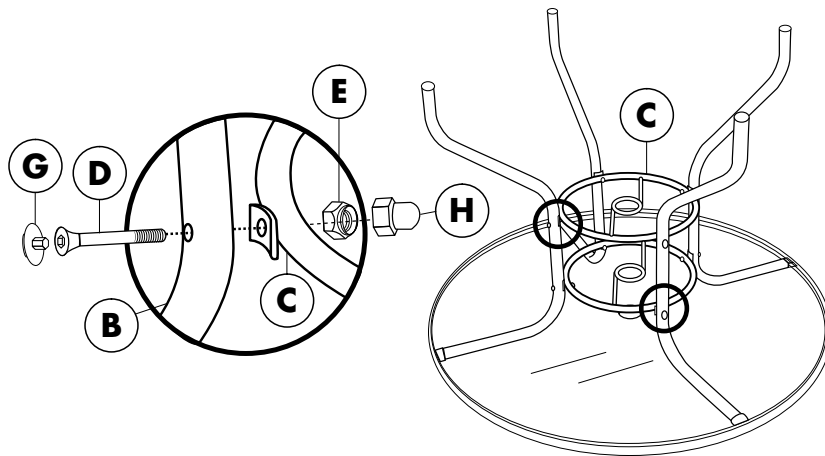

Insert four Screws 1/4x55 (D) through holes of Legs (B) and through Leg Ring (C). It is advised to keep these parts loose until unit is completely assembled. Follow these same steps to assemble the second Leg Ring (C) to the additional set of holes on Legs (B). Once assembly is complete, tighten all screws and nuts. Insert Covers (G) over screw heads of Screws 1/4x55 (D). Insert Nut Covers (H) over Nuts (E) to hide their appearances.

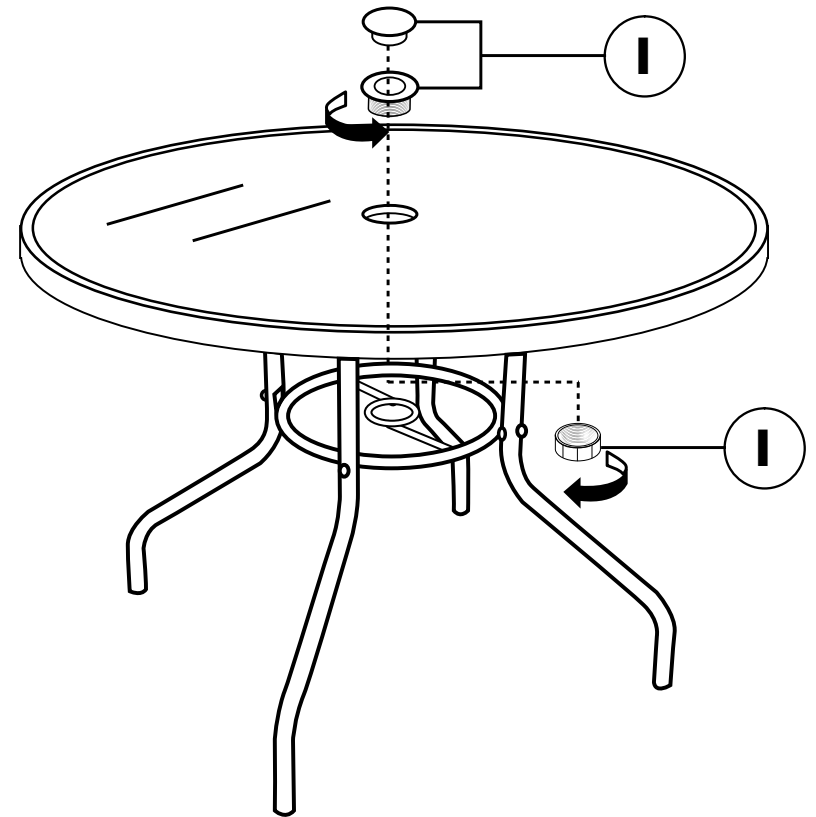

Turn the table right-side up. Remove the center cap from the Table Ring (I). Unscrew the lower-half of the Table Ring (I) by turning it counter-clockwise. When separated, you'll have three parts including: center cap, lower-half with inside threading, upper-half with outside threading. Reach under the table with the lower-half in one hand, while reaching over the table with the upper-half in the other hand. Bring the two pieces together at the center of the table where a hole is cutout in the glass. Screw the two pieces back together and tighten by turning the lower-half clockwise. Place the center cap back when an umbrella isn't being used.

LIMITED WARRANTY

Please contact our service hotline by phone, email or fax before sending the device. This allows us to provide support in the event of possible operator errors.

All furniture manufactured and sold by TDC USA, Inc. is warranted to the original purchaser against defects in workmanship and materials. If a product manufactured by TDC fails during the first year from date of purchase under the terms of our limited warranty, TDC will replace the item at no charge. After one year, it will be the original purchasers' responsibility to pay for freight and packing. TDC reserves the right, in the case of discontinued or out of production models, to replace with an item of similar quality. (Glass breakage is not warranted.)

Note: You must retain original receipt to obtain warranty!

Frames:

Frames are warranted against defects in materials and workmanship from the date of original purchase. Damage to frames or welds due to commercial use, improper assembly, exposure to water and sub-freezing temperatures, and/or abuse are not covered.

Fabric:

Fabric on cushions, slings, and umbrellas is warranted against separation at the seams. Fading, mildew, and/or discoloration due to exposure to elements, chemicals, and spills are not covered.

Powder coat and/or Paint:

The finish is warranted against blistering, peeling, or cracking. Fading resulting from exposure to elements, chemicals, and spills are not covered. Scratches and chips due to normal wear and use are not covered.

Umbrella:

Umbrella frames are warranted against manufacturer's defects in workmanship and materials.

Safety Warning! Umbrellas must be closed when not in use and taken down in windy conditions.

Freight & Packing:

TDC will be responsible for shipping, handling, and packaging charges for all valid warranty claims.

Care & Maintenance:

Be careful to never allow water build up in frames as this will cause corrosion and freeze damage in cold climates. Wash all frames with a solution of mild soap and water. Rinse with clean water and dry with a soft absorbent cloth towel. Frames can be treated with a liquid wax for maximum protection against UV rays and/or salty damp air. If your set includes cushions, slings, and/or an umbrella, they may be cleaned by hand with a solution of soap and water with a clean water rinse.

EXCLUSION:

- Damage caused by acts of nature
- Wind damage
- Failure caused by unreasonable, unanticipated or abusive use
- Failure caused by a lack of reasonable and necessary care and maintenance
- Normal fade of fabrics, upholstery or woven materials
- Glass table tops
- Bursting or cracking of tubing due to exposure to water and freezing temperatures
- Changes in wood color due to the natural aging of the wood

Lack of original receipt will void warranty.

Customer Service: Monday-Friday 9:00am-5:00pm EST

By Phone: 800-599-8898

By E-mail: support@tdcusainc.com



Distributed By T.D.C. USA INC.

Fairfield, NJ 07004

©2017 All Rights Reserved. Made in China

?/Comments: 1-800-599-8898 9am-5pm EST

www.tdcusainc.com