

Warranty

5

1. This gazebo is not a permanent structure and should be disassembled and stored away after use.
2. Do not repack your gazebo until completely dry.
3. This gazebo must be assembled by two adults or more.
4. This gazebo must not be left erect in windy conditions.
5. Loading limit of the hook is 10 lbs.
6. Steel components for garden accessories and furniture are treated with rust inhibiting paint that protects them from rust. However, due to the nature of steel, surface oxidation (rusting) will occur if this protective coating is scratched. This is a natural process. To minimize this condition, it is recommended that care be taken when assembling and handling the product in order to prevent the paint from being scratched. If scratching or damage occurs, it is recommended that the area be touched-up immediately with rust inhibiting paint, which is included in the package. Surface rust can be removed easily using a very light application of common cooking oil. If surface oxidation (rusting) occurs and no measures are taken to correct it, the oxidation may start dripping on the deck or patio, which may cause damaging strains that may be difficult to remove.

GARDENLINE®

10 ft x 10 ft Gazebo

User Guide



Now that you have purchased a Gardenline® product you can rest assured in the knowledge that as well as your 2 year parts and labour guarantee you have the added peace of mind of dedicated helplines and web support.

AFTER SALES SUPPORT

 1 800 599 8898  support@tdcusainc.com

MODEL: 7884/21474-13

occur if the protective coating is scratched. It is recommended that care be taken when assembling and handling the product in order to prevent the paint from being scratched. If scratching or damage occurs, it is recommended that the area be touched up immediately with rust inhibiting paint. Surface rust can be removed easily using a very light application of common cooking oil. If rusting occurs and is not treated correctly, the oxidation may start dripping onto the deck or patio. This may result in stains that are difficult to remove.

Fabric

Fabric on cushions, slings, and umbrellas is warranted against separation at the seams. Fading, mildew, and/or discoloration due to exposure to elements, chemicals, and spills are not covered.

Powder coat and/or Paint

The finish is warranted against blistering, peeling, or cracking. Fading resulting from exposure to elements, chemicals, and spills are not covered. Scratches and chips due to normal wear and use are not covered.

Freight & Packing

The manufacturer will be responsible for shipping, handling, and packaging charges for all valid warranty claims.

Care & Maintenance

Be careful to never allow water build up in frames as this will cause corrosion and freeze damage in cold climates. Wash all frames with a solution of mild soap and water. Rinse with clean water and dry with a soft absorbent cloth towel. Frames can be treated with a liquid wax for maximum protection against UV rays and/or salty damp air. If your set includes cushions, slings, and/or an umbrella, they may be cleaned by hand with a solution of soap and water with a clean water rinse.

Congratulations!

You have made an excellent choice with the purchase of this quality Gardenline® product. By doing so you now have the assurance and peace of mind which comes from purchasing a product that has been manufactured to the highest standards of performance and safety, supported by the high quality standards of ALDI.

We want you to be completely satisfied with your purchase so this Gardenline® product is backed by a comprehensive manufacturer's 2 year warranty and an outstanding after sales service through our dedicated Helpline.

We hope you will enjoy using your purchase for many years to come.

If you require technical support or in the unlikely event that your purchase is faulty please telephone our Helpline for immediate assistance. Faulty product claims made within the 2 year warranty period will be repaired or replaced free of charge provided that you have satisfactory proof of purchase (keep your till receipt safe!). This does not affect your statutory rights. However, be aware that the warranty will become null and void if the product is found to have been deliberately damaged, misused or disassembled.

Getting Started

3

Identify all parts packaged in carton against the parts list. Remove all protective materials and place parts on a non-abrasive surface to avoid scratching. If any parts are missing or damaged, **DO NOT** attempt to assemble. Please contact our customer service center (Monday-Friday 9:00 am – 5:00 pm EST) at 1-800-599-8898.

Caution

Read all the instructions before assembly. Failure to do so may result in faulty assembly and potential injury! Assemble product on a soft, non-abrasive surface such as a carpet or cardboard to avoid damaging the item. Seek assistance to assemble bulky or heavy items. After final alignment, make sure all bolts and nuts are securely tightened with screw covers pressed in place.

Assemble gazebo on a level site with sufficient space. To prevent accidents and possible serious injuries, keep children and pets away on the assembly site during assembly and erection. This gazebo is a garden ornament, not a play set. Do not use the gazebo for purposes other than original purpose of the product.

6

Assembly Instructions

4

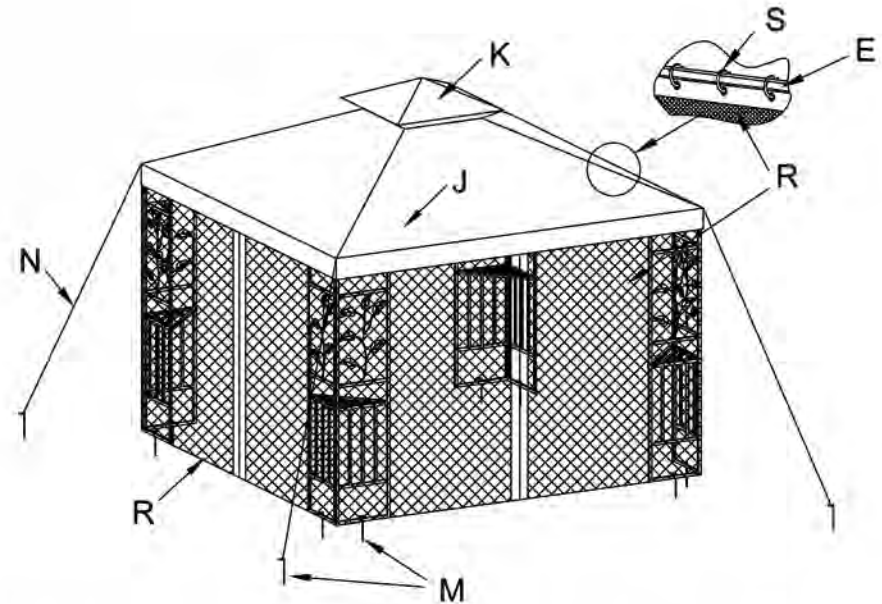

Put the Main Canopy (J) on the top of the gazebo from one side to another. Slip the rib ends into the pockets of the canopy. Velcro the Small Canopy (K) to the Main Canopy (J). Hammer the Stakes (M) through the bottom of the panels into the ground. To enforce stability, loop Rope (N) onto the corner of the Main Canopy (J) and tie the other end of the Rope (N) to Stake (M).

Insert the Plastic Rings (S) onto the metal grommets on the top of the Netting (R). Hook the Plastic Rings (S) around the outside of the gazebo on the Cross Beams (E & T).

11

Assembly Instructions

4

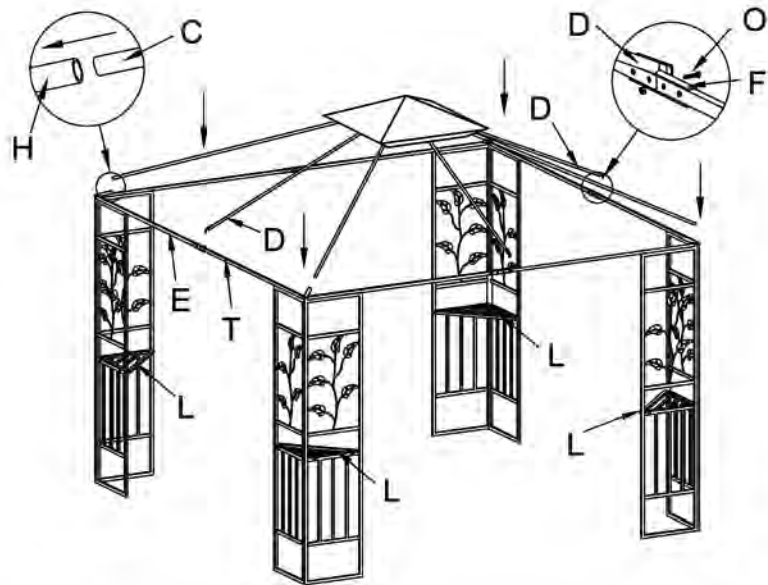

Carefully place the newly formed roof on top of the gazebo. Connect the Corner Canopy Rib (C) to the Corner Connector (H) that is on the top corner of the panels. Secure the Canopy Middle Rib (D) to the Cross Beam Connector (F). Assemble by using M6 x 25mm screw & nut (O).

10

Assembly Instructions

4

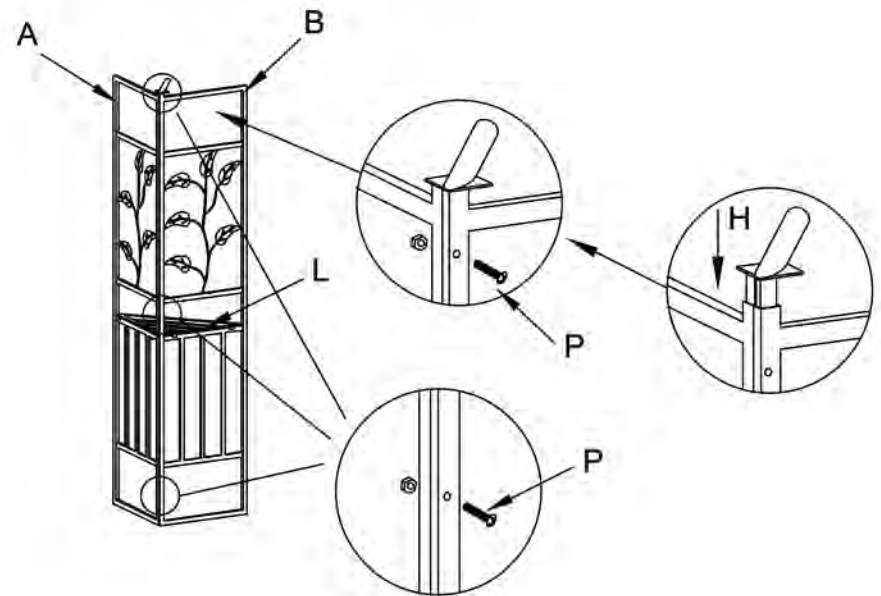

At the lower portion of the the panel, using two M6 x 40mm Screws & Nuts (P), screw the 17" Panel (B) onto 16" Panel (A). At the top corner, first place the Corner Connector (H) into the corner of the attached panels, then use M6 x 40mm Screws & Nuts (P) to screw all the pieces together. Continue finishing one set of panels by adding the Corner Shelf (L) to the panels. See picture above.

7

Assembly Instructions

4

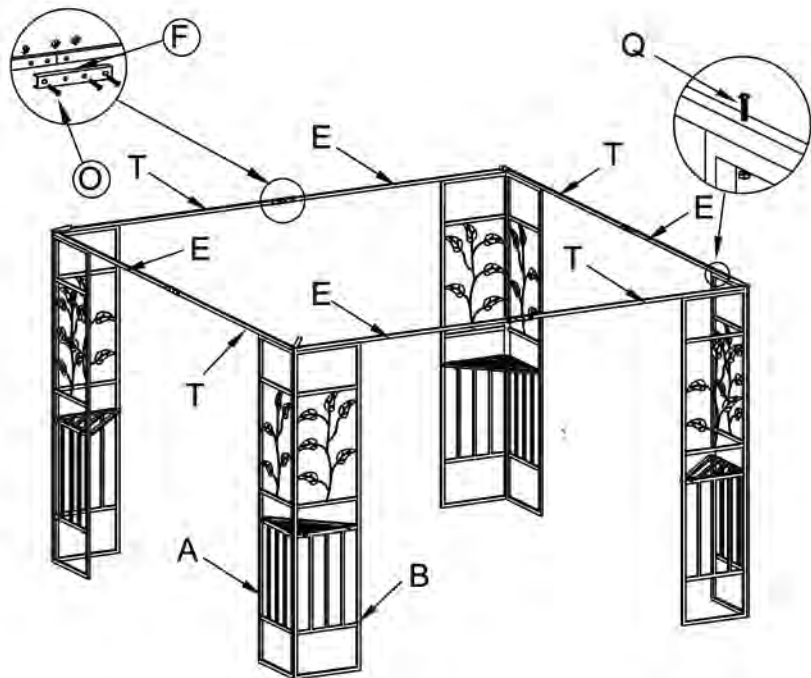

Connect Cross Beam (E) & (T) together with Cross Beam Connector (F), secure by using 3 pcs M6 x 25mm Screws & Nuts (O). Leave one screw hole empty to be used on page 10. Place the attached crossbeams on top of the panels. Cross Beam (E) goes on top of panel (B) and Cross Beam (T) goes on top of Panel (A). Use M6 x 48mm Screws & Nuts (Q) to secure the cross beams to the panels. Please see above picture for reference.

8

Assembly Instructions

4

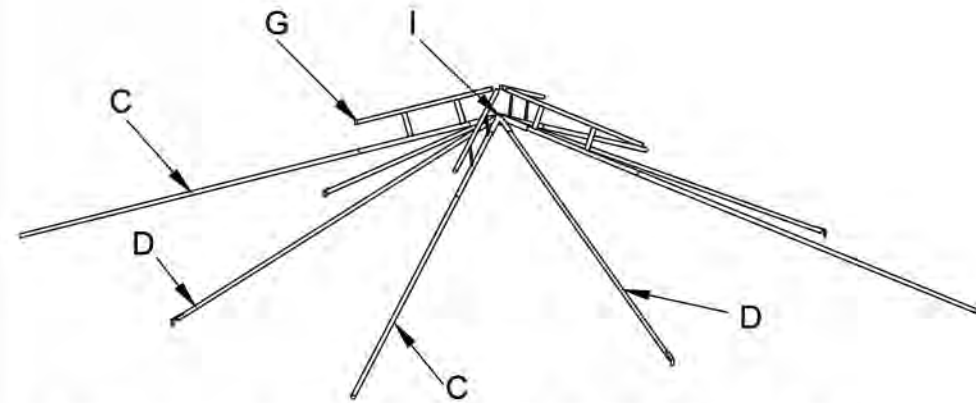







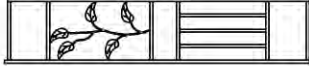

Alternate inserting the Canopy Middle Rib (D) and Canopy Two Tier Rib (G) into Connector (I). Make sure the spring loaded button is snapped through the slot and locked in place on the connector. The Canopy Middle Rib (D) should be placed into the smaller pipe of the Connector (I). Place Corner Canopy Rib (C) into the Canopy Two Tier Rib (G).

Place the Small Canopy (K) onto the Two Tier Ribs (G). Slip the rib ends into the corner pockets of the canopy.

Loading limit of the hook is 10 lbs.

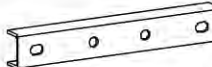
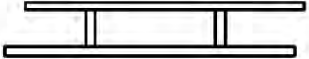
9

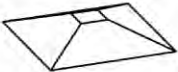
Parts			
	Picture	Description	Qty
A		16" Panel (5 Leaves)	4
B		17" Panel (6 Leaves)	4
C		Corner Canopy Rib	4
D		Canopy Middle Rib	4
E		Cross Beam	4
T		Cross Beam	4
F		Cross Beam Connector	4
G		Canopy Two Tier Ribs	4
H		Corner Connector	4
I		Connector	1
J		Main Canopy	1

Two Year Limited Warranty

All furniture manufactured and sold by Aldi is warranted to the original purchaser against defects in workmanship and materials, provided the item was factory sealed at the time of purchase and is maintained with care and used only for personal purposes. If a product fails during the first two years from date of purchase under the terms of our limited warranty, the manufacturer will replace the item at no charge. If the item was purchased as an open box, previously returned, or clearance item, you may obtain replacement parts for a nominal cost if parts are still available. After two years, it will be the original purchasers' responsibility to pay for freight and packing. The manufacturer reserves the right, in the case of discontinued or out of production models, to replace with an item of similar quality. Warranty is to the original purchaser and is non-transferable. (Glass breakage is not warranted.)

Note: You must retain original receipt to obtain warranty!

Frames

Frames are warranted against defects in materials and workmanship from the date of original purchase. Damage to frames or welds due to commercial use, improper assembly, exposure to water and sub-freezing temperatures, and/or abuse are not covered. The finish is warranted against blistering, peeling, or cracking. Fading resulting from exposure to elements, chemicals, and spills are not covered. Scratches and chips due to normal wear and use are not covered. Steel components are treated with rust inhibiting paint that protects them from rust. However, due to the nature of steel, rusting will

Assembly Instructions

4

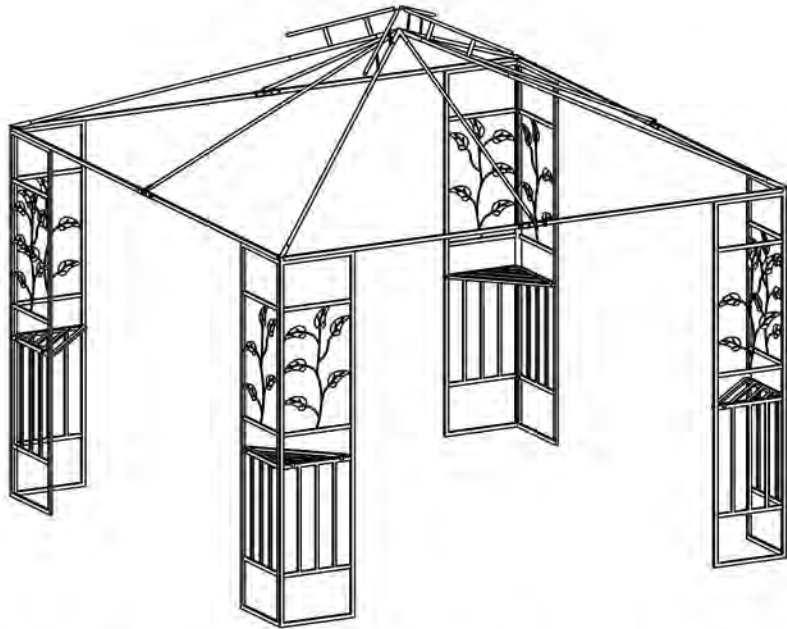







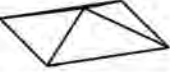

Note: In case of adverse weather conditions or strong wind, please remove the Main Canopy (J) from the gazebo.

This gazebo is susceptible to wind. Please make sure each rope at the corners is tightly staked down and each stake at the bottom of the panel is hammered down. In the event of adverse weather conditions, it is highly recommended that the Main Canopy is removed from the gazebo so that no damage will occur to the gazebo.

This product is designed for leisure use only and is not a shelter against adverse weather conditions.

Parts List

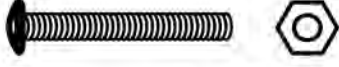
2

Parts			
	Picture	Description	Qty
K		Small Canopy	1
L		Corner Shelf	4
M		Stake	12
N		Rope	4
O		M6 x 25mm Screws & Nuts	16
P		M6 x 40mm Screws & Nuts	12
Q		M6 x 48mm Screws & Nuts	16
R		Netting Panel	4
S		Plastic Ring	32

Contents

- 1 Introduction
- 2 Parts List
- 3 Getting Started
- 4 Assembly Instructions
- 5 Warranty

Warranty

Exclusions

- Damage caused by acts of nature (weather damage)
- Wind damage
- Failure caused by unreasonable, unanticipated or abusive use
- Failure caused by a lack of reasonable and necessary care and maintenance
- Normal fade of fabrics, upholstery or woven materials
- Glass table tops
- Bursting or cracking of tubing due to exposure to water and freezing temperatures
- Changes in wood color due to the natural aging of the wood
- General frame rusting

WARNING

KEEP ALL FLAME AND HEAT SOURCES AWAY FROM THIS TENT FABRIC. This tent is made with fabric that meets CPAI-84 specifications for flame resistance. It is not fire proof. The fabric will burn if left in continuous contact with any flame source. The application of any foreign substance to the tent fabric may render the flame-resistant properties ineffective.

Proof of purchase (dated register receipt and store name) is required for warranty claims.
Lack of original receipt will void warranty.

Customer Service

Monday-Friday 9:00am-5:00pm EST

Phone: 800-599-8898

Fax: 973-227-7189

Email: support@tdcusainc.com

Web: www.tdcusainc.com