



**GARDENLINE**



# 10' x 10' Gazebo

Powder coated steel frame



## User Guide

By choosing a Gardenline product, you now have the assurance and peace of mind that comes with a product backed by a warranty and customer support. If you have any questions or concerns, please use the toll-free customer support phone number.

### CUSTOMER SUPPORT

US HELPLINE NUMBER | 800 599 8898

MODEL NUMBER: 7884

Page #3	Introduction
Page #4	Getting Started
Page #5	Parts List
Page #7	Assembly Instructions
Page #13	Warranty

### Exclusion:

- Damage caused by acts of nature
- Wind damage
- Failure caused by unreasonable, unanticipated or abusive use
- Failure caused by a lack of reasonable and necessary care and maintenance
- Normal fade of fabrics, upholstery or woven materials
- Glass table tops
- Bursting or cracking of tubing due to exposure to water and freezing temperatures
- Changes in wood color due to the natural aging of the wood

Lack of original receipt will void warranty.

Customer Service: Monday-Friday 9:00am-5:00pm EST  
Address: TDC, 1275 Valley Brook Ave, Lyndhurst, NJ 07071  
By Phone: 800-599-8898  
By Fax: 201-935-7004  
By E-mail: [support@tdcusainc.com](mailto:support@tdcusainc.com)

Keep all flame and heat sources away from this tent fabric. This tent is made with fabric that meets CPAI-84 specifications for flame resistance. It is not fire proof. The fabric will burn if left in continuous contact with any flame source.

**Powder coat and/or Paint:**

The finish is warranted against blistering, peeling, or cracking. Fading resulting from exposure to elements, chemicals, and spills are not covered. Scratches and chips due to normal wear and use are not covered

**Umbrella:**

Umbrella frames are warranted against manufacturer's defects in workmanship and materials.

Safety Warning! Umbrellas must be closed when not in use and taken down in windy condition.

**Freight & Packing:**

TDC will be responsible for shipping, handling, and packaging charges for all valid warranty claims.

**Care & Maintenance:**

Be careful to never allow water build up in frames as this will cause corrosion and freeze damage in cold climates. Wash all frames with a solution of mild soap and water. Rinse with clean water and dry with a soft absorbent cloth towel. Frames can be treated with a liquid wax for maximum protection against UV rays and/or salty damp air. If your set includes cushions, slings, and/or an umbrella, they may be cleaned by hand with a solution of soap and water with a clean water rinse.

Congratulations on choosing a Gardenline product. In doing so, you now have the assurance and peace of mind that comes with a product made by one of ALDI's select manufacturers.

All products brought to you by Gardenline are manufactured to the highest performance and safety standards. Because of our dedication to customer service and satisfaction, this product is backed by our comprehensive Two (2) Year Manufacturer's Warranty.

It is our hope that you will enjoy using your purchase for many years to come.

Identify all parts packaged in carton against the parts list. Remove all protective materials and place parts on a non-abrasive surface to avoid scratching. If any parts are missing or damaged, DO NOT attempt to assemble. Please contact our customer service center (Monday-Friday 9:00am – 5:00pm EST) at 1-800-599-8898 or email: [support@tdcusainc.com](mailto:support@tdcusainc.com).

**Caution:** Read all the instructions before assembly. Failure to do so may result in faulty assembly and potential injury! Assemble product on a soft, non-abrasive surface such as a carpet or cardboard to avoid damaging the item. Seek assistance to assemble bulky or heavy items. After final alignment, make sure all bolts and nuts are securely tightened with screw covers pressed in place.

Assemble gazebo on a level site with sufficient space. To prevent accidents and possible serious injuries, keep children and pets away on the assembly site during assembly and erection. This gazebo is a garden ornament, not a play set. Do not use the gazebo for purposes other than original purpose of the product.

### Two Year Limited Warranty

All furniture manufactured and sold by TDC USA, Inc. is warranted to the original purchaser against defects in workmanship and materials. If a product manufactured by TDC fails during the first two years from date of purchase under the terms of our limited warranty, TDC will replace the item at no charge. After two years, it will be the original purchasers' responsibility to pay for freight and packing. TDC reserves the right, in the case of discontinued or out of production models, to replace with an item of similar quality. (Glass breakage is not warranted.)

**Note: You must retain original receipt to obtain warranty!**

### Frames:

Frames are warranted against defects in materials and workmanship from the date of original purchase. Damage to frames or welds due to commercial use, improper assembly, exposure to water and sub-freezing temperatures, and/or abuse are not covered.





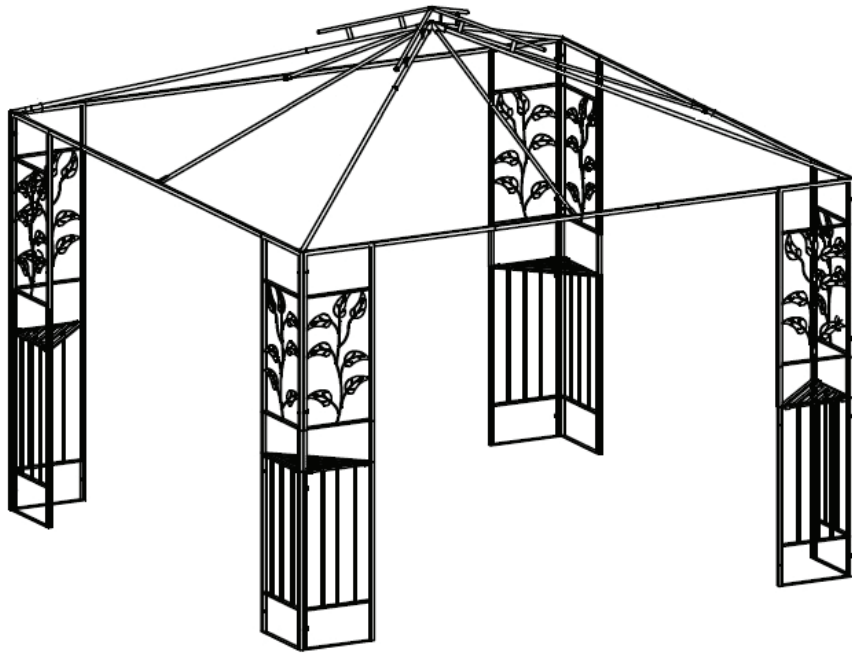

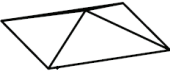

### Fabric:

Fabric on cushions, slings, and umbrellas is warranted against separation at the seams. Fading, mildew, and/or discoloration due to exposure to elements, chemicals, and spills are not covered.



In case of adverse weather conditions or strong wind, please remove the Main Canopy (J) from the gazebo.

Parts			
	Picture	Description	Qty
A		16" Panel	4
B		17" Panel	4
C		Corner Canopy Rib	4
D		Canopy Middle Rib	4
E		Cross Beam	4
F		Cross Beam	4
G		Canopy Two Tier Ribs	4
H		Corner Connector	4
I		Connector	1
J		Main Canopy	1

Parts			
	Picture	Description	Qty
K		Small Canopy	1
L		Corner Shelf	4
M		Stake	12
N		Rope	4
O		M6 x 20mm Screw & Nuts	8
P		M6 x 40mm Screw & Nut	12
Q		M6 x 48mm Screw & Nut	16
R		Netting Panel	4
S		Plastic Ring	32

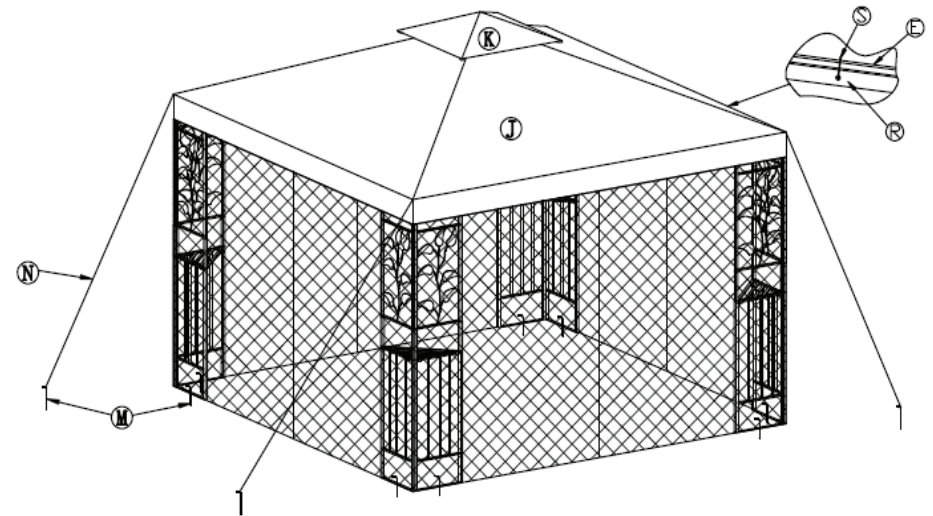

Put the Main Canopy (J) on the top of the gazebo from one side to another. Slip the rib ends into the pockets of the canopy. Velcro the Small Canopy (K) to the Main Canopy (J). Hammer the Stakes (M) through the bottom of the panels into the ground. To enforce stability, loop Rope (N) onto the corner of the Main Canopy (J) and tie the other end of the Rope (N) to Stake (M).

Insert the Plastic Rings (S) onto the metal grommets on the top of the Netting (R). Hook the Plastic Rings (S) around the outside of the gazebo on the Cross Beams (E & F).

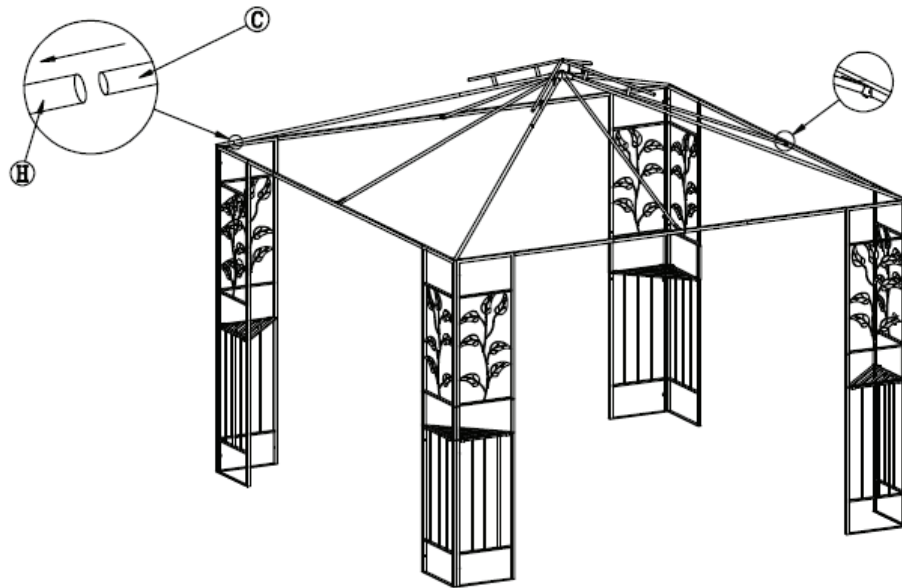

Carefully place the newly formed roof on top of the gazebo. Connect the Corner Canopy Rib (C) to the Corner Connector (H) that is on top of the panels. Also slide the flat piece on the end of the Canopy Middle Rib (D) in the slot on the connected cross beams.

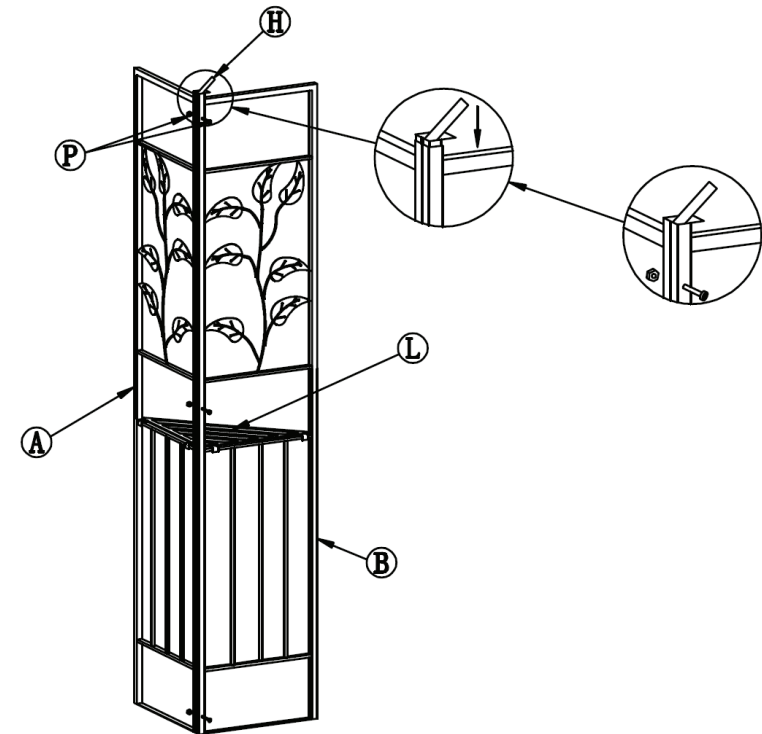

Using three M6 x40mm Screw & Nut (P), screw the 17" Panel (B) onto 16" Panel (A). At the top corner, first place the Corner Connector (H) into the corner of the attached panels, then use M6 x 40mm Screw & Nut (P) to screw all the pieces together. Continue finishing one set of panels by adding the Corner Shelf (L) to the panels. See picture above.



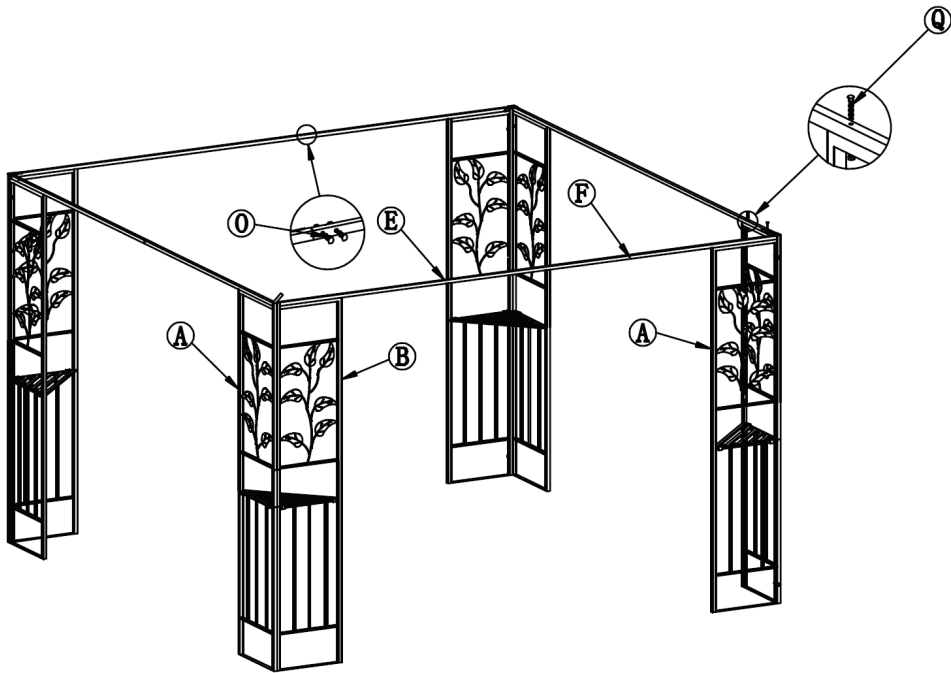

Put Cross Beam (F) into Cross Beam (E) and screw together at the joint area using M6 x 20mm Screw & Nut (O). Place the attached cross beams on top of two different panels. Use M6 x 48mm Screws & Nut (Q) to secure the cross beams to the panels. Please see above picture for reference.

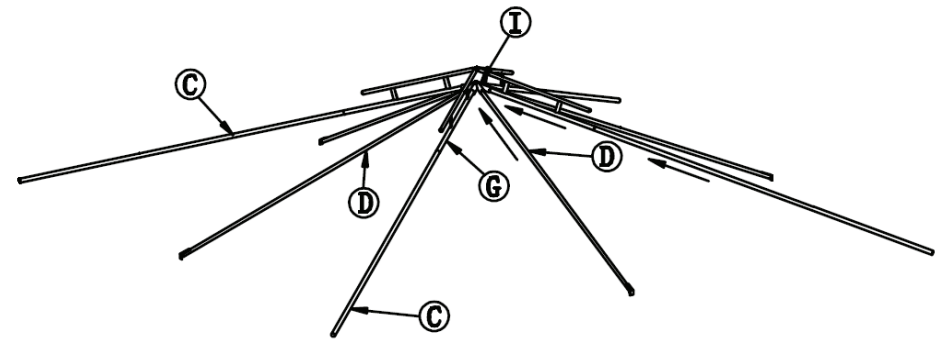

Alternate inserting the Canopy Middle Rib (D) and Canopy Two Tier Rib (G) into Connector (I). Make sure the spring loaded button is snapped through the slot and locked in place on the connector. The Canopy Middle Rib (D) should be placed into the smaller pipe of the Connector (I). Place Corner Canopy Rib (C) into the Canopy Two Tier Rib (G).

Place the Small Canopy (K) onto the Two Tier Ribs (G). Slip the rib ends into the corner pockets of the canopy.