



# ***INNOVATIVE*** ***MOUNTS***

*2018 Product Catalogue*  
*[www.innovativemounts.com](http://www.innovativemounts.com)*



# Innovative's Story

For over a decade, Innovative Mounts has created hundreds of performance engine mount kits for many of the world's most popular cars. Our experience in manufacturing, passion for Motorsports and pride in our brand can be seen in every product we offer.

Manufacturing has always been an essential part of our business and over the last twenty years, we have created tens of thousands of products for customers all over the world. Our factory in California utilizes state of the art machinery and software that produce our industry leading products. Our products are designed, cut, bent, welded, power coated, finished and packaged all by our west coast team. This allows us to not only produce products at a rapid pace but maintain strict QC standards throughout the process.

Our engineering and product development teams share a deep passion for Motorsports and are enthusiasts in the automotive industry. We live and breathe it. With access to our own Romer arm and various 3D scanning tools, we have the keys to engineering success and the team to drive it home.

Ultimately, customer satisfaction is our top priority which is why we offer a lifetime warranty on all Innovative Mount products. We take pride in our brand and hope that customers all over the world can experience our passion for reliable, affordable and quality performance parts.

We appreciate your interest in our company and hope that you continue to support the Innovative Mounts brand as we keep creating great products!

---

1366 N. Hundley St. Anaheim, CA 92806

P. (714) 524-5246      F. (714) 399-0996

[sales@innovativemounts.com](mailto:sales@innovativemounts.com)

[tech@innovativemounts.com](mailto:tech@innovativemounts.com)

# Table of Contents

<b>ENGINE MOUNT KITS</b>	<b>5 - 50</b>
<b>TRACTION BAR KITS</b>	<b>51 - 52</b>
<b>ACCESSORIES</b>	<b>53 - 57</b>



# Innovative Bushings

**One of the most common questions is:** “What stiffness bushing should I use?”

**The answer is** “It depends on how you use the car.”

All engine mount systems are a compromise between controlling the engine movement and isolating **NVH** (*Noise, Vibration and Harshness as felt by the driver/passenger*). **Softer bushings** will do a better job at minimizing NVH at the expense of allowing more engine movement and compromising performance. Conversely, a **harder bushing** will minimize engine movement, maximize performance but increase the NVH. Ultimately the **right bushing** is the one that provides the best balance for how you intend on using the car. We offer a wide variety of choices so that you can find a solution that best meets the intended use.

**60A (Red\* Urethane)** – This is our softest bushing. Primarily intended for OEM/stock engines, daily commuting and non-aggressive driving. Available as a standard option for all our mount kits

**75A (Black\* Urethane)** – Designed for street and occasional track use. Still a daily driver, but want the increased performance and control that performance bushing offers. Depending on the individual tuning of your drivetrain, may notice a slight to mild increase in NVH over a stock/OEM mount. Good up to 500 HP. Available as a standard option for all our mount kits.

**85A (Grey\* Urethane)** – A more aggressive bushing for Race and fully built engines. Designed for maximizing performance and minimizing engine movement. Will notice significant an increase in NVH over stock. Best suited for engines ranging from 500-1000 HP. These are available as upgraded bushings with a \$10.00 upcharge.

**95A (Dark Red\* Urethane)** – Designed for extreme race and maximum horsepower and where NVH is not a consideration. These bushings are capable of handling 1,000+ HP. These are available as upgraded bushings with a \$10.00 upcharge.

**Solid Bushings** – For ultimate control and performance we offer solid bushings as an option for our Billet Mounts.

\* Custom Colors can be ordered for any bushing stiffness for an additional \$60 lot charge.



# Innovative Engine Mount Kits

Our engine mounts are produced from high-quality materials and are built to withstand the added stresses of performance applications. Available in high-strength powder coated steel or lightweight billet aluminum we offer many options for tons of applications. Add a touch of personality by taking advantage of our custom anodizing options available on all billet parts. From street car bushings to full solid race car mounts, all products are backed by our industry-leading lifetime warranty!

## 1984-1987 HONDA CIVIC/CRX 18750

CHASSIS	ENGINE / TRANS	KIT TYPE	RETAIL PRICE
AF/AH/AT/EC	B-Swap/Man./Cable	Steel	\$349.99



PART NUMBER	CHASSIS	ENGINE / TRANS	RETAIL PRICE
18710	AF/AH/EC	B-Swap/Man./Cable	\$115.00
18720-SB	AF/AH/EC	B-Swap/Man./Cable	\$84.99
19320	AF/AH/EC/DA	B-Swap/Man./Cable	\$119.99
18730	AF/AH/EC	B-Swap/Man./Cable	\$115.00



# 1988-1991 HONDA CIVIC/CRX

**B19151 / 19151**

CHASSIS	ENGINE / TRANS	KIT TYPE	RETAIL PRICE
ED/EE/EF	D-Series/Cable	Billet	\$299.99
ED/EE/EF	D-Series/Cable	Steel	\$199.99



PART NUMBER	CHASSIS	ENGINE / TRANS	RETAIL PRICE
B19111	ED/EE/EF	D-Series(-92)/Cable	\$139.99
B19121	ED/EE/EF	D-Series/Cable	\$139.99
B19131	ED/EE/EF	D-Series/Cable	\$149.99
19111	ED/EE/EF	D-Series/Cable	\$119.99
19121	ED/EE/EF	D-Series/Cable	\$119.99
19131	ED/EE/EF	D-Series/Cable	\$115.99



# 1988-1991 HONDA CIVIC/CRX

**49151**

CHASSIS	ENGINE / TRANS	KIT TYPE	RETAIL PRICE
ED/EE/EF	D-Series(-92 engine)/Man./Hydro/Cable2Hydro	Steel	\$374.99



PART NUMBER	CHASSIS	ENGINE / TRANS	RETAIL PRICE
19111	ED/EE/EF	D-Series(-92)/Cable	\$115.99
49121	ED/EE/EF	D-Series/Man./Hydro/Cable2Hydro	\$115.99
49131	ED/EE/EF	D-Series/Hydro/Cable2Hydro	\$115.99
49131-SB	ED/EE/EF	D-Series/Hydro/Cable2Hydro	\$75.00
41002(Actuator)	ED/EE/EF	D-Series/Cable	\$119.99



# 1988-1991 HONDA CIVIC/CRX

**49152**

CHASSIS	ENGINE / TRANS	KIT TYPE	RETAIL PRICE
ED/EE/EF	D-Series(92+ engine)/Man./Hydro/Cable2Hydro	Steel	\$374.99



PART NUMBER	CHASSIS	ENGINE / TRANS	RETAIL PRICE
49111	ED/EE/EF	D-Series(92+)/Cable	\$115.00
49121	ED/EE/EF	D-Series/Man./Hydro/Cable2Hydro	\$115.99
49131	ED/EE/EF	D-Series/Hydro/Cable2Hydro	\$115.99
49131-SB	ED/EE/EF	D-Series/Hydro/Cable2Hydro	\$75.00
41002(Actuator)	ED/EE/EF	D-Series/Cable	\$149.99



# 1988-1991 HONDA CIVIC/CRX

## B19150 / 19150

CHASSIS	ENGINE / TRANS	KIT TYPE	RETAIL PRICE
ED/EE/EF	B-Swap/Cable	Billet	\$299.99
ED/EE/EF	B-Swap/Cable	Steel	\$199.99



PART NUMBER	CHASSIS	ENGINE / TRANS	RETAIL PRICE
B19110	ED/EE/EF	B-Series	\$139.99
B19120	ED/EE/EF	B-Series/Cable	\$139.99
B19130	ED/EE/EF	B-Series	\$139.99
19110	ED/EE/EF	B-Series	\$119.99
19120	ED/EE/EF	B-Series/Cable	\$115.99
19130	ED/EE/EF	B-Series/Cable	\$119.99



# 1988-1991 HONDA CIVIC/CRX

## B49150 / 49150

CHASSIS	ENGINE / TRANS	KIT TYPE	RETAIL PRICE
ED/EE/EF	B-Swap/Man./Hydro	Billet	\$299.99
ED/EE/EF	B-Swap/Man./Hydro/Cable2Hydro	Steel	\$349.99



PART NUMBER	CHASSIS	ENGINE / TRANS	RETAIL PRICE
B19110	ED/EE/EF	B-Series	\$139.99
B49120	ED/EE/EF	B-Series/Man./Hydro	\$139.99
B19130	ED/EE/EF	B-Series	\$139.99
19110	ED/EE/EF	B-Series	\$119.99
49120	ED/EE/EF	B-Series/Man./Hydro	\$129.99
19130	ED/EE/EF	B-Series	\$119.99
41000(Actuator)	ED/EE/EF	B-Series/Cable2Hydro	\$149.99



# 1988-1991 HONDA CIVIC/CRX

## 99150

CHASSIS	ENGINE / TRANS	KIT TYPE	RETAIL PRICE
ED/EE/EF	K-Swap/Man./Auto2Man./Hydro	Steel	\$428.25



PART NUMBER	CHASSIS	ENGINE / TRANS	RETAIL PRICE
99110	ED/EE/EF	K-Swap/Man./Auto2Man.	\$129.99
99120	ED/EE/EF	K-Swap	\$115.00
99120-SB	ED/EE/EF	K-Swap	\$50.00
99130	ED/EE/EF	K-Swap/Man./Auto2Man.	\$125.99
99130-SB	ED/EE/EF	K-Swap/Man./Auto2Man.	\$50.00



# 1988-1991 HONDA CIVIC/CRX

**29150**

CHASSIS	ENGINE / TRANS	KIT TYPE	RETAIL PRICE
ED/EE/EF	H/F-Swap/Man./Hydro	Steel	\$399.99



PART NUMBER	CHASSIS	ENGINE / TRANS	RETAIL PRICE
29110	ED/EE/EF	H/F-Swap	\$115.00
20020	DC/ED/EE/EF/EJ	H/F-Swap/Man.	\$115.99
29120-SB	ED/EE/EF	H/F-Swap/Man.	\$50.00
29130	ED/EE/EF	H/F-Swap/Man.	\$125.00
41003	ED/EE/EF	H-Series/Cable2Hydro	\$149.99



# 1988-1991 HONDA CIVIC/CRX

**19153**

CHASSIS	ENGINE / TRANS	KIT TYPE	RETAIL PRICE
EE4/EE5/EF4/EF5	D-Series/4WD/Cable	Steel	\$249.99



PART NUMBER	CHASSIS	ENGINE / TRANS	RETAIL PRICE
19111	ED/EE/EF	D-Series(-92)/Cable	\$115.99
19123	EE4/EE5/EF4/EF5	D-Series/4WD/Cable	\$84.99
19131	ED/EE/EF	D-Series/Cable	\$115.99



# 1988-1991 HONDA CIVIC/CRX

**19152**

CHASSIS	ENGINE / TRANS	KIT TYPE	RETAIL PRICE
EE8/EE9/EF8/EF9	B-Series(JDM/EDM)/RHD/Man./Cable	Steel	\$249.99



PART NUMBER	CHASSIS	ENGINE / TRANS	RETAIL PRICE
19310	DA/ED/EE/EF	B-Series	\$99.99
19122	EE8/EE9/EF8/EF9	B-Series(JDM/EDM)/RHD/Cable	\$115.99
49132	EE8/EE9/EF8/EF9	B-Series(JDM/EDM)/RHD	\$99.99





# 1988-1991 HONDA CIVIC/CRX

**49153**

CHASSIS	ENGINE / TRANS	KIT TYPE	RETAIL PRICE
EE8/EE9/EF8/EF9	B-Series(JDM/EDM)/RHD/Man./Hydro	Steel	\$249.99



PART NUMBER	CHASSIS	ENGINE / TRANS	RETAIL PRICE
19310	DA/ED/EE/EF	B-Series	\$99.99
49123	EE8/EE9/EF8/EF9	B-Series(JDM/EDM)/RHD/Man./Hydro	\$99.99
49132	EE4/EE5/EF4/EF5	B-Series(JDM/EDM)/RHD/Man./Hydro	\$99.99



# 1992-1995 HONDA CIVIC

**B19550/19550**

CHASSIS	ENGINE / TRANS	KIT TYPE	RETAIL PRICE
EG/EH/EJ	B/D-Series/Man./Hydro	Billet	\$299.99
EG/EH/EJ	B/D-Series/Man./Hydro	Steel	\$269.99



PART NUMBER	CHASSIS	ENGINE / TRANS	RETAIL PRICE
B19510	DC/EG/EH/EJ	B/D-Series	\$135.00
B10120	DC/EG/EH/EJ	B/D-Series/Man./Hydro	\$139.99
B10130	DC/EG/EH/EJ/MB/RD	B/D-Series	\$149.99
19510	DC/EG/EH/EJ	B/D-Series	\$115.00
10120	DC/EG/EH/EJ	B/D-Series/Man./Hydro	\$119.99
10130	DC/EG/EH/EJ/MB/RD	B/D-Series/Hydro	\$115.99



# 1992-1995 HONDA CIVIC

**B10150/10150**

CHASSIS	ENGINE / TRANS	KIT TYPE	RETAIL PRICE
EG/EH/EJ	B-Swap/Man./Hydro/H2B	Billet	\$299.99
EG/EH/EJ	B-Swap/Man./Hydro/H2B	Steel	\$269.99



PART NUMBER	CHASSIS	ENGINE / TRANS	RETAIL PRICE
B10110	DC/EG/EH/EJ	B/D-Series/GSR Style	\$149.00
B10120	DC/EG/EH/EJ	B/D-Series/Man./Hydro	\$139.99
B10130	DC/EG/EH/EJ/MB/RD	B/D-Series	\$149.99
10110	DC/EG/EH/EJ	B/D-Series/GSR Style	\$115.00
10120	DC/EG/EH/EJ	B/D-Series/Man./Hydro	\$119.99
10130	DC/EG/EH/EJ/MB/RD	B/D-Series/Hydro	\$115.99



# 1992-1995 HONDA CIVIC

19552

CHASSIS	ENGINE / TRANS	KIT TYPE	RETAIL PRICE
EG/EH/EJ	B/D-Series/Auto/Hydro	Steel	\$269.99



PART NUMBER	CHASSIS	ENGINE / TRANS	RETAIL PRICE
19510	DC/EG/EH/EJ	B/D-Series	\$115.00
19522	DC/EG/EH/EJ	B/D-Series	\$115.99
10130	DC/EG/EH/EJ/MB/RD	B/D-Series/Hydro	\$115.99



# 1992-1995 HONDA CIVIC

49552

CHASSIS	ENGINE / TRANS	KIT TYPE	RETAIL PRICE
EG/EH/EJ	B/D-Series/Auto2Man./Cable	Steel	\$329.99



PART NUMBER	CHASSIS	ENGINE / TRANS	RETAIL PRICE
19510	DC/EG/EH/EJ	B/D-Series	\$115.00
49522	EG/EH/EJ	B/D-Series/Auto2Man./Cable	\$149.99
10130	DC/EG/EH/EJ/MB/RD	B/D-Series/Hydro	\$115.99
40120-SB(Actuator)	DC/EG/EH/EJ	B/D-Series/Auto2Man.	\$50.00



# 1992-1995 HONDA CIVIC

B49550/49550

CHASSIS	ENGINE / TRANS	KIT TYPE	RETAIL PRICE
EG/EH/EJ	B/D-Series/Auto2Man./Hydro	Billet	\$299.99
EG/EH/EJ	B/D-Series/Auto2Man./Hydro	Steel	\$269.99



B49550



49550

PART NUMBER	CHASSIS	ENGINE / TRANS	RETAIL PRICE
B19510	DC/EG/EH/EJ	B/D-Series	\$135.00
B49520	EG/EH/EJ	B/D-Series/Auto2Man./Hydro	\$149.99
B10130	DC/EG/EH/EJ/MB/RD	B/D-Series/Hydro	\$149.99
19510	DC/EG/EH/EJ	B/D-Series	\$115.00
49520	EG/EH/EJ	B/D-Series/Auto2Man./Hydro	\$129.99
10130	DC/EG/EH/EJ/MB/RD	B/D-Series/Hydro	\$115.00



# 1992-1995 HONDA CIVIC

**49553**

CHASSIS	ENGINE / TRANS	KIT TYPE	RETAIL PRICE
EG/EH/EJ	B/D-Series/Man./Hydro2Cable	Steel	\$299.99



PART NUMBER	CHASSIS	ENGINE / TRANS	RETAIL PRICE
19510	DC/EG/EH/EJ	B/D-Series	\$115.00
40120	DC/EG/EH/EJ	B-Series/Man./Hydro2Cable	\$149.99
10130	DC/EG/EH/EJ/MB/RD	B/D-Series/Hydro	\$115.99
40120-SB	DC/EG/EH/EJ	B/D-Series/Hydro2Cable	\$50.00



**19510** (LH)      **40120** (RH)      **40120-SB** (Actuator)      **10130** (Rear)

# 1992-1995 HONDA CIVIC

**40150**

CHASSIS	ENGINE / TRANS	KIT TYPE	RETAIL PRICE
EG/EH/EJ	B/D-Swap/Man./Hydro2Cable	Steel	\$299.99



PART NUMBER	CHASSIS	ENGINE / TRANS	RETAIL PRICE
10110	DC/EG/EH/EJ	B/D-Series/GSR Style	\$115.00
40120	DC/EG/EH/EJ	B/D-Series/Auto2Man./Cable	\$149.99
10130	DC/EG/EH/EJ/MB/RD	B/D-Series/Hydro	\$115.99
40120-SB(Actuator)	DC/EG/EH/EJ	B/D-Series/Auto2Man.	\$50.00



**10110** (LH)      **40120** (RH)      **40120-SB** (Actuator)      **10130** (Rear)

# 1992-1995 HONDA CIVIC

**80150**

CHASSIS	ENGINE / TRANS	KIT TYPE	RETAIL PRICE
EG/EH/EJ	J-Swap/Man./Hydro	Steel	\$499.99



PART NUMBER	CHASSIS	ENGINE / TRANS	RETAIL PRICE
80110	DC/EG/EH/EJ	J-Swap/Man.	\$119.99
80110-SB	DC/EG/EH/EJ	J-Swap/Man.	\$49.99
80120	DC/EG/EH/EJ	J-Swap	\$119.99
80120-SB	DC/EG/EH/EJ	J-Swap	\$75.00
80130	DC/EG/EH/EJ	J-Swap/Man.	\$119.00
80130-SB	DC/EG/EH/EJ	J-Swap/Man.	\$149.99
80150-SB	DC/EG/EH/EJ	J-Swap	\$149.99



**80110** (LH)      **80110-SB** (LH)      **80120** (RH)      **80120-SB** (RH)      **80130** (Rear)      **80130-SB** (Rear)      **80150-SB** (Alt. Re-locator)

# 1992-1995 HONDA CIVIC

**80151**

CHASSIS	ENGINE / TRANS	KIT TYPE	RETAIL PRICE
EG/EH/EJ	J-Swap/Man./Hydro	Steel	\$429.99



PART NUMBER	CHASSIS	ENGINE / TRANS	RETAIL PRICE
80110	DC/EG/EH/EJ	J-Swap/Man.	\$119.99
80110-SB	DC/EG/EH/EJ	J-Swap/Man.	\$49.99
80120	DC/EG/EH/EJ	J-Swap	\$119.99
80120-SB	DC/EG/EH/EJ	J-Swap	\$75.00
80130	DC/EG/EH/EJ	J-Swap/Man.	\$124.99
80130-SB	DC/EG/EH/EJ	J-Swap/Man.	\$49.99



# 1992-1995 HONDA CIVIC

**B29550/29550**

CHASSIS	ENGINE / TRANS	KIT TYPE	RETAIL PRICE
EG/EH/EJ	H-Swap/Man./Auto2Man./Hydro	Billet	\$363.56
EG/EH/EJ	H-Swap/Man./Auto2Man./Hydro	Steel	\$299.99



PART NUMBER	CHASSIS	ENGINE / TRANS	RETAIL PRICE
B29510	DC/EG/EH/EJ	H-Swap	\$115.00
B29520	DC/EG/EH/EJ	H-Swap/Man./Auto2Man./Hydro	\$125.99
29520-SB	DC/EG/EH/EJ	H-Swap/Man./Auto2Man./Hydro	\$75.00
B29530	DC/EG/EH/EJ	H-Swap/Man./Auto2Man./Hydro	\$115.99
29510	DC/EG/EH/EJ	H-Swap	\$115.00
20020	DC/EG/EH/EJ	H-Swap/Man./Auto2Man./Hydro	\$115.99
29520-SB	DC/EG/EH/EJ	H-Swap/Man.	\$75.00
29530	DC/EG/EH/EJ	H-Swap	\$115.99



# 1992-1995 HONDA CIVIC

## B90150/90150

CHASSIS	ENGINE / TRANS	KIT TYPE	RETAIL PRICE
EG/EH/EJ	K-Swap/Man./Auto2Man./Hydro	Billet	\$499.99
EG/EH/EJ	K-Swap/Man./Auto2Man./Hydro	Steel	\$429.99



PART NUMBER	CHASSIS	ENGINE / TRANS	RETAIL PRICE
B10110	DC/EG/EH/EJ	K-Swap/Man./Auto2Man./GSR Style	\$149.00
B90110-SB	DC/EG/EH/EJ	K-Swap	\$149.99
B90120	DC/EG/EH/EJ	K-Swap	\$115.99
90120-SB	DC/EG/EH/EJ	K-Swap	\$80.00
B90130	DC/EG/EH/EJ	K-Swap/Man./Auto2Man.	\$164.99
90130-SB	DC/EG/EH/EJ	K-Swap/Man./Auto2Man.	\$50.00
90110	DC/EG/EH/EJ	K-Swap/Man.	\$115.00
90120	CB/DC/EG/EH/EJ	K-Swap	\$129.99
90120-SB	DC/EG/EH/EJ	K-Swap	\$80.00
90130	DC/EG/EH/EJ	K-Swap/Man.	\$159.99
90130-SB	DC/EG/EH/EJ	K-Swap/Man.	\$50.00



# 1996-2000 HONDA CIVIC

## 10052

CHASSIS	ENGINE / TRANS	KIT TYPE	RETAIL PRICE
EJ7/EN1	D-Swap/CVT2Man.	Steel	\$379.99



PART NUMBER	CHASSIS	ENGINE / TRANS	RETAIL PRICE
10010	EJ/EK/EM/MB	D-Swap	\$139.99
10010-SB	EJ/EK/EM/MB	D-Swap	\$50.00
10120	DC/EG/EH/EJ/EK/MB	B/D-Swap/CVT2Man.	\$119.99
10021-SB	EJ7/EN1	D-Swap/CVT2Man.	\$99.99
10130	DC/EG/EH/EJ/EM/MB/RD	B/D-Swap	\$99.99



# 1996-2000 HONDA CIVIC

# B10050/10050

CHASSIS	ENGINE / TRANS	KIT TYPE	RETAIL PRICE
EJ/EK/EM	B/D-Series/Hydro	Billet	\$329.99
EJ/EK/EM	B/D-Series/Hydro	Steel	\$279.99



**B10050**



**10050**

PART NUMBER	CHASSIS	ENGINE / TRANS	RETAIL PRICE
B10010	EJ/EK/EM	B/D-Series/Hydro	\$149.99
10010-SB	EJ/EK/EM	B/D-Series/Hydro	\$50.00
B10020	EJ/EK/EM/MB/RD	B/D-Series/Hydro	\$135.00
B10130	DC/EG/EH/EJ/EK/EM	B/D-Series/Hydro	\$149.99
10010	EJ/EK/EM	B/D-Series/Hydro	\$139.99
10010-SB	EJ/EK/EM	B/D-Series/Hydro	\$50.00
10020	EJ/EK/EM/MB/RD	B/D-Series/Hydro	\$115.99
10130	DC/EG/EH/EJ/EM/MB/RD	B/D-Series/Hydro	\$115.99



**B10010**  
(LH)



**10010-SB**  
(LH)



**B10020**  
(RH)



**B10130**  
(Rear)



**10010**  
(LH)



**10010-SB**  
(LH)



**10020**  
(RH)



**10130**  
(Rear)

# 1996-2000 HONDA CIVIC

# B90050/90050

CHASSIS	ENGINE / TRANS	KIT TYPE	RETAIL PRICE
EJ/EK/EM	K-Swap/Hydro	Billet	\$499.99
EJ/EK/EM	K-Swap/Hydro	Steel	\$428.25



**B90050**



**90050**

PART NUMBER	CHASSIS	ENGINE / TRANS	RETAIL PRICE
B90010	EJ/EK/EM/FA/FD/FG/FN	K-Swap/Hydro	\$164.99
90010-SB	EJ/EK/EM	K-Swap/Hydro	\$50.00
B90120	DC/EG/EH/EJ/EK/EM/FG	K-Swap/Hydro	\$115.99
90020-SB	EJ/EK/EM	K-Swap/Hydro	\$50.00
B90130	EJ/EK/EM	K-Swap/Hydro	\$164.99
90030-SB	EJ/EK/EM	K-Swap/Hydro	\$100.00
90010	EJ/EK/EM/FD/FG/FN	K-Swap/Hydro	\$115.99
90010-SB	EJ/EK/EM	K-Swap/Hydro	\$50.00
90120	DC/EG/EH/EJ/EK/EM/FG	K-Swap/Hydro	\$129.99
90020-SB	EJ/EK/EM	K-Swap/Hydro	\$50.00
90130	DC/EG/EH/EJ/EK/EM	K-Swap/Hydro	\$159.99
90030-SB	EJ/EK/EM	K-Swap/Hydro	\$100.00



**90010-SB**  
(LH)



**B90010**  
(LH)



**B90120**  
(RH)



**90020-SB**  
(RH)



**B90130**  
(Rear)



**90030-SB**  
(Rear)



**90010**  
(LH)



**90010-SB**  
(LH)



**90120**  
(RH)



**90020-SB**  
(RH)



**90130**  
(Rear)



**90030-SB**  
(Rear)

# 1996-2000 HONDA CIVIC

**80050**

CHASSIS	ENGINE / TRANS	KIT TYPE	RETAIL PRICE
EJ/EK/EM	J-Swap/EG Subframe/Man.	Steel	\$499.99



PART NUMBER	CHASSIS	ENGINE / TRANS	RETAIL PRICE
80010	BB/EJ/EK	J-Swap/Man./EG Subframe	\$119.99
80010-SB	BB/EJ/EK	J-Swap/Man./EG Subframe	\$99.99
80020	BB/EJ/EK	J-Swap/Man./EG Subframe	\$119.99
80020-SB	BB/EJ/EK	J-Swap/Man./EG Subframe	\$74.99
80030	BB/EJ/EK	J-Swap/Man./EG Subframe	\$115.00
80030-SB	BB/EJ/EK	J-Swap/Man./EG Subframe	\$60.00



# 1996-2000 HONDA CIVIC

**B90051/90051**

CHASSIS	ENGINE / TRANS	KIT TYPE	RETAIL PRICE
EJ/EK/EM	K-Swap/EG Subframe	Billet	\$499.99
EJ/EK/EM	K-Swap/EG Subframe	Steel	\$428.25



**B90051**



**90051**

PART NUMBER	CHASSIS	ENGINE / TRANS	RETAIL PRICE
B90010	EJ/EK/EM/FA/FD/FG/FN	K-Swap/EG Subframe	\$164.99
90011-SB	EJ/EK/EM	K-Swap/EG Subframe	\$75.00
B90120	DC/EG/EH/EJ/EK/EM/FG	K-Swap/EG Subframe	\$115.99
90021-SB	EJ/EK/EM	K-Swap/EG Subframe	\$50.00
B90130	EJ/EK/EM	K-Swap/EG Subframe	\$164.99
90031-SB	EJ/EK/EM	K-Swap/EG Subframe	\$49.99
90010	EJ/EK/EM/FD/FG/FN	K-Swap/EG Subframe	\$115.99
90011-SB	EJ/EK/EM	K-Swap/EG Subframe	\$75.00
90120	DC/EG/EH/EJ/EK/EM/FG	K-Swap/EG Subframe	\$129.99
90021-SB	EJ/EK/EM	K-Swap/EG Subframe	\$50.00
90130	DC/EG/EH/EJ/EK/EM	K-Swap/EG Subframe	\$159.99
90031-SB	EJ/EK/EM	K-Swap/EG Subframe	\$49.99



# 1996-2000 HONDA CIVIC

**B20050/20050**

CHASSIS	ENGINE / TRANS	KIT TYPE	RETAIL PRICE
EJ/EK/EM	F/H-Swap/Man./Hydro	Billet	\$399.99
EJ/EK/EM	F/H-Swap/Man./Hydro	Steel	\$299.99



**B20050**



**20050**

PART NUMBER	CHASSIS	ENGINE / TRANS	RETAIL PRICE
B20010	EJ/EK/EM	F/H-Swap	\$135.00
10010-SB	EJ/EK/EM/MB	F/H-Swap	\$50.00
B29520	DC/EG/EH/EJ/EK/EM	F/H-Swap/Man./Hydro	\$125.99
20020-SB	ED/EE/EF/EJ/EK/EM	F/H-Swap/Man./Hydro	\$50.00
B20030	EJ/EK/EM	F/H-Swap/Man./Hydro	\$149.99
20010	EJ/EK/EM	F/H-Swap	\$115.99
10010-SB	EJ/EK/EM/MB	F/H-Swap	\$50.00
20020	DC/ED/EE/EF/EG/EH/EJ	F/H-Swap/Man./Hydro	\$115.99
20020-SB	ED/EE/EF/EJ/EK/EM	F/H-Swap/Man./Hydro	\$50.00
20030	EJ/EK/EM	F/H-Swap/Man./Hydro	\$119.99



**B20010**  
(LH)



**10010-SB**  
(LH)



**B29520**  
(RH)



**20020-SB**  
(RH)



**B20030**  
(Rear)



**20010**  
(LH)



**10010-SB**  
(LH)



**20020**  
(RH)



**20020-SB**  
(RH)



**20030**  
(Rear)

# 2001-2005 HONDA CIVIC

**10550**

CHASSIS	ENGINE / TRANS	KIT TYPE	RETAIL PRICE
EM2	D-Series/Hydro	Steel	\$299.99



PART NUMBER	CHASSIS	ENGINE / TRANS	RETAIL PRICE
10510	EM2	D-Series	\$149.99
10510-SB	EM2	D-Series	\$34.99
10520	EM2	D-Series	\$129.99
10530	EM2	D-Series	\$129.99



**10510**  
(LH)



**10510-SB**  
(LH)



**10520**  
(RH)



**10530**  
(Rear)



# 2001-2005 HONDA CIVIC

**90550**

CHASSIS	ENGINE / TRANS	KIT TYPE	RETAIL PRICE
EM2	K-Swap	Steel	\$499.99



PART NUMBER	CHASSIS	ENGINE / TRANS	RETAIL PRICE
10510	EM2	K-Swap	\$149.99
90510-SB	EM2	K-Swap	\$79.99
90520	EM2	K-Swap	\$119.99
90520-SB	EM2	K-Swap	\$49.99
90630	DC/EP/EM/RD/YH	K-Swap/Man.	\$115.99
90640	DC/EP/FG/RD/YH	K-Swap/Man.	\$126.99



**10510** (LH)    **90510-SB** (LH)    **90520** (RH)    **90520-SB** (RH)    **90630** (Rear)    **90640** (Front)

# 2002-2006 HONDA CIVIC Si

**B90650/90650**

CHASSIS	ENGINE / TRANS	KIT TYPE	RETAIL PRICE
EP3	K-Series/Man.	Billet	\$384.99
EP3	K-Series/Man.	Steel	\$299.99



**B90650**

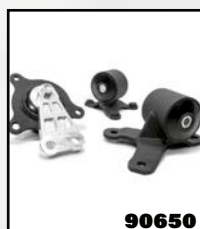

**90650**

PART NUMBER	CHASSIS	ENGINE / TRANS	RETAIL PRICE
B90610	DC5/EP3/RD/YH	K-Series	\$149.99
B90620	DC5/EP3	K-Series	\$159.99
B90621	DC5/EP3	K-Series	\$54.99
B90630	DC5/EP3/RD	K-Series	\$149.99
90610	DC5/EP3	K-Series	\$149.99
90620	DC5/EP3	K-Series	\$149.99
B90621	DC5/EP3	K-Series	\$54.99
90630	DC5/EP3/RD/YH	K-Series	\$115.99



**B90610** (LH)    **B90620** (RH)    **B90621** (RH)    **B90630** (Rear)    **90610** (LH)    **90620** (RH)    **B90621** (RH)    **90630** (Rear)

# 2006-2011 HONDA CIVIC Si

**90850**

CHASSIS	ENGINE / TRANS	KIT TYPE	RETAIL PRICE
EM2	K-Series/Man.	Steel	\$499.99



PART NUMBER	CHASSIS	ENGINE / TRANS	RETAIL PRICE
90010	EK/EJ/FB/FG	K-Series	\$115.99
90810-SB	FG	K-Series/Man.	\$74.99
90120	CB/DC/EG/EH/EJ/EK/FB/FG	K-Series	\$129.99
90820-SB	FB/FG	K-Series	\$79.99
91430	FB/FG	K-Series/Man.	\$129.99
90830-SB	FG	K-Series	\$49.99
90640	DC5/EP3/RD/YH	K-Series/Man.	\$126.99



**90010** (LH)    **90810-SB** (LH)    **90120** (RH)    **90820-SB** (RH)    **91430** (Rear)    **90830-SB** (Rear)    **90640** (Front)

# 2012-2015 HONDA CIVIC Si

**91250**

CHASSIS	ENGINE / TRANS	KIT TYPE	RETAIL PRICE
FB/FG	K-Series/Man.	Steel	\$399.99



PART NUMBER	CHASSIS	ENGINE / TRANS	RETAIL PRICE
90010	EK/EJ/FB/FG	K-Series	\$115.99
91410-SB	FB/FG	K-Series	\$79.99
90120	CB/DC/EG/EH/EJ/EK/FB/FG	K-Series	\$129.99
90820-SB	FB/FG	K-Series	\$79.99
91430	FB/FG	K-Series/Man.	\$129.99
91430-SB	FB/FG	K-Series/Man.	\$39.99



# 1986-1989 HONDA ACCORD

**18950**

CHASSIS	ENGINE / TRANS	KIT TYPE	RETAIL PRICE
CA	B-Swap/Cable	Steel	\$349.99



PART NUMBER	CHASSIS	ENGINE / TRANS	RETAIL PRICE
18912	CA	B-Series/Cable	\$115.00
18920	CA	B-Series/Cable	\$115.00
18920-SB	CA	B-Series/Cable	\$119.99
18930	CA	B-Series/Cable	\$119.99



# 1990-1993 HONDA ACCORD

**29355**

CHASSIS	ENGINE / TRANS	KIT TYPE	RETAIL PRICE
CB7/CB9(DX/LX)	F-Series/Man./90-93 Trans.	Steel	\$299.99



PART NUMBER	CHASSIS	ENGINE / TRANS	RETAIL PRICE
29310	CB7/CB9	F/H-Series	\$115.00
29323	CB7/CB9	F-Series/Man.	\$129.99
29630	BA/BB/CB/CD	B/F/H-Series	\$115.99



# 1990-1993 HONDA ACCORD

**29356**

CHASSIS	ENGINE / TRANS	KIT TYPE	RETAIL PRICE
CB7/CB9(EX)	F-Series/Man./90-93 Trans.	Steel	\$299.99



PART NUMBER	CHASSIS	ENGINE / TRANS	RETAIL PRICE
29310	CB7/CB9	F/H-Series	\$115.00
29323	CB7/CB9	F-Series/Man.	\$129.99
29731	CB7	F-Series/Man.	\$115.99



# 1990-1993 HONDA ACCORD

**29353**

CHASSIS	ENGINE / TRANS	KIT TYPE	RETAIL PRICE
CB7/CB9(EX/DX/LX)	F-Series/Auto	Steel	\$299.99



PART NUMBER	CHASSIS	ENGINE / TRANS	RETAIL PRICE
29310	CB7/CB9	F/H-Series	\$115.00
29322	BA/CB7/CB9	F-Series/Auto	\$119.99
29332	CB/CD/CE/RA	F-Series/Auto	\$115.99



# 1990-1993 HONDA ACCORD

**29358**

CHASSIS	ENGINE / TRANS	KIT TYPE	RETAIL PRICE
CB7/CB9(DX/LX)	F-Series/Auto2Man./90-93 Trans.	Steel	\$299.99



PART NUMBER	CHASSIS	ENGINE / TRANS	RETAIL PRICE
29310	CB7/CB9	F/H-Series	\$115.00
29325	CB7/CB9	F-Series/Auto2Man./90-93 Trans.	\$119.99
29630	CB7/CB9	B/F/H-Series	\$115.99



# 1990-1993 HONDA ACCORD

**29352**

CHASSIS	ENGINE / TRANS	KIT TYPE	RETAIL PRICE
CB7/CB9(EX)	F-Series/Auto2Man./90-93 Trans.	Steel	\$299.99



PART NUMBER	CHASSIS	ENGINE / TRANS	RETAIL PRICE
29310	CB7/CB9	F/H-Series	\$115.00
29325	CB7/CB9	F-Series/Auto2Man./90-93 Trans.	\$119.99
29731	CB/CD	F-Series/Man.	\$115.99



# 1990-1993 HONDA ACCORD

**29350**

CHASSIS	ENGINE / TRANS	KIT TYPE	RETAIL PRICE
CB7/CB9(DX/LX)	F/H-Swap/Man./94-01 Trans.	Steel	\$299.99



PART NUMBER	CHASSIS	ENGINE / TRANS	RETAIL PRICE
29310	CB7/CB9	F/H-Series	\$115.00
29320	CB7/CB9	F-Series/Man./94-01 Trans.	\$115.00
29630	CB/CD	B/F/H-Series	\$115.99



# 1990-1993 HONDA ACCORD

**29351**

CHASSIS	ENGINE / TRANS	KIT TYPE	RETAIL PRICE
CB7/CB9(EX)	F/H-Swap/Man./94-01 Trans.	Steel	\$299.99



PART NUMBER	CHASSIS	ENGINE / TRANS	RETAIL PRICE
29310	CB7/CB9	F/H-Series	\$115.00
29320	CB7/CB9	H-Series/F-Series Trans.(94-01)/Man.	\$115.00
29731	CB/CD	F-Series/Man.	\$115.99



721A	1
721B	1
1-310	1
1-125	2
1-350	1

FINISH: BLACK WRINKLE

NAME	SIGNATURE	DATE	TITLE

# 1990-1993 HONDA ACCORD

**29359**

CHASSIS	ENGINE / TRANS	KIT TYPE	RETAIL PRICE
CB7/CB9(DX/LX)	F/H-Swap/Auto2Man./94-01 Trans.	Steel	\$299.99



PART NUMBER	CHASSIS	ENGINE / TRANS	RETAIL PRICE
29310	CB7/CB9	F/H-Series	\$115.00
29324	CB/CD/CE	F/H-Series/Auto2Man./94-01 Trans.	\$119.99
29630	BA/BB/CB/CD	B/F/H-Series	\$115.99



# 1990-1993 HONDA ACCORD

**29357**

CHASSIS	ENGINE / TRANS	KIT TYPE	RETAIL PRICE
CB7/CB9(EX)	F/H-Swap/Auto2Man./94-01 Trans.	Steel	\$299.99



PART NUMBER	CHASSIS	ENGINE / TRANS	RETAIL PRICE
29310	CB7/CB9	F/H-Series	\$115.00
29324	BB/CB7/CB9	F/H-Series/Auto2Man./94-01 Trans.	\$119.99
29731	CB/CD	F-Series/Man.	\$115.99



# 1990-1993 HONDA ACCORD

**99352**

CHASSIS	ENGINE / TRANS	KIT TYPE	RETAIL PRICE
CB7/CB9	K-Swap/Hydro	Steel	\$428.25



PART NUMBER	CHASSIS	ENGINE / TRANS	RETAIL PRICE
99312	CB	K-Series	\$124.99
90120	CB/FB/FG	K-Series	\$129.99
99322-SB	CB	K-Series	\$30.00
99332	CB	K-Series	\$125.00
99332-SB	CB	K-Series	\$45.00



# 1994-1997 HONDA ACCORD

**29754**

CHASSIS	ENGINE / TRANS	KIT TYPE	RETAIL PRICE
CD5/CD7/CE1(DX/LX)	F-Series/Man.	Steel	\$299.99



PART NUMBER	CHASSIS	ENGINE / TRANS	RETAIL PRICE
29711	CD/CE/RA/YA	F-Series	\$115.99
29720	CD/CE	F-Series/Man.	\$149.99
29630	BA/BB/CD/CE	B/F/H-Series	\$115.99

<b>29711</b> (LH)	<b>29720</b> (RH)	<b>29630</b> (Rear)

# 1994-1997 HONDA ACCORD

**29950**

CHASSIS	ENGINE / TRANS	KIT TYPE	RETAIL PRICE
CD5/CD7/CE1(DX/LX)	F-Series/Auto2Man.	Steel	\$299.99



PART NUMBER	CHASSIS	ENGINE / TRANS	RETAIL PRICE
29711	CD/CE/RA/YA	F-Series	\$115.99
29324	CB/CD/CE	F/H-Series/Auto2Man./94-01 Trans.	\$119.99
29630	BA/BB/CB/CD	B/F/H-Series	\$115.99

<b>29711</b> (LH)	<b>29324</b> (RH)	<b>29630</b> (Rear)

# 1994-1997 HONDA ACCORD

**29757**

CHASSIS	ENGINE / TRANS	KIT TYPE	RETAIL PRICE
CD5/CD7/CE1(EX)	F-Series/Man.	Steel	\$299.99



PART NUMBER	CHASSIS	ENGINE / TRANS	RETAIL PRICE
29711	CD/CE/RA/YA	F-Series	\$115.99
29720	CD/CE	F-Series/Man.	\$149.99
29731	CB/CD	F-Series/Man.	\$115.99

<b>29711</b> (LH)	<b>29720</b> (RH)	<b>29731</b> (Rear)

# 1994-1997 HONDA ACCORD

**29756**

CHASSIS	ENGINE / TRANS	KIT TYPE	RETAIL PRICE
CD5/CD7/CE1(DX/LX)	F-Series/Auto	Steel	\$299.99



PART NUMBER	CHASSIS	ENGINE / TRANS	RETAIL PRICE
29711	CD/CE/RA/YA	F-Series	\$115.99
29322	BA/BB/CB/CD	F-Series/Auto	\$119.99
29332	CB/CD/CE/RA	F-Series/Auto	\$30.00



**29711**  
(LH)

**29322**  
(RH)

**29332**  
(Rear)

# 1994-1997 HONDA ACCORD

**29750**

CHASSIS	ENGINE / TRANS	KIT TYPE	RETAIL PRICE
CD5/CD7/CE1(DX/LX)	H22/F22A-Swap/Man.	Steel	\$299.99



PART NUMBER	CHASSIS	ENGINE / TRANS	RETAIL PRICE
29710	CD/CE	F/H-Series	\$115.99
29620	BB/CD/CE/RA	F-Series/Man.	\$115.99
29630	BA/BB/CB/CD/CE	F-Series/Man.	\$115.99



**29710**  
(LH)

**29620**  
(RH)

**29630**  
(Rear)

# 1994-1997 HONDA ACCORD

**29751**

CHASSIS	ENGINE / TRANS	KIT TYPE	RETAIL PRICE
CD5/CD7/CE1(EX)	H22/F22A-Swap/Man.	Steel	\$299.99



PART NUMBER	CHASSIS	ENGINE / TRANS	RETAIL PRICE
29710	CD/CE	F/H-Series	\$115.99
29620	BB/CD/CE/RA	F-Series/Man.	\$115.99
29731	CB/CD/CE	F-Series/Man.	\$115.99



**29710**  
(LH)

**29620**  
(RH)

**29731**  
(Rear)

# 1994-1997 HONDA ACCORD

**29755**

CHASSIS	ENGINE / TRANS	KIT TYPE	RETAIL PRICE
CD5/CD7/CE1(EX/DX/LX)	H22/F22A-Swap/Auto	Steel	\$299.99



PART NUMBER	CHASSIS	ENGINE / TRANS	RETAIL PRICE
29710	CD/CE	F/H-Series	\$115.99
29322	BA/CB/CD	F-Series/Auto	\$119.99
29332	CD/CE	F/H-Series/Auto	\$115.99



# 1994-1997 HONDA ACCORD

**29758**

CHASSIS	ENGINE / TRANS	KIT TYPE	RETAIL PRICE
CD5/CD7/CE1(DX/LX)	H22/F22A-Swap/Auto2Man.	Steel	\$299.99



PART NUMBER	CHASSIS	ENGINE / TRANS	RETAIL PRICE
29710	CD/CE	F/H-Series	\$115.99
29324	CB/CD/CE	F/H-Series/Auto2Man./94-01 Trans.	\$119.99
29630	BA/BB/CB/CD	B/F/H-Series	\$115.99



# 1994-1997 HONDA ACCORD

**29759**

CHASSIS	ENGINE / TRANS	KIT TYPE	RETAIL PRICE
CD5/CD7/CE1(EX)	H23/F20B/Auto2Man.	Steel	\$299.99



PART NUMBER	CHASSIS	ENGINE / TRANS	RETAIL PRICE
29711	CD/CE/RA/YA	F-Series	\$115.99
29325	CD/CE/RA/YA	F-Series	\$119.99
29731	CB/CD	F-Series/Man.	\$115.99





# 1994-1997 HONDA ACCORD

**29752**

CHASSIS	ENGINE / TRANS	KIT TYPE	RETAIL PRICE
CD5/CD7/CE1(DX/LX)	H23/F20B-Swap/Man.	Steel	\$299.99



PART NUMBER	CHASSIS	ENGINE / TRANS	RETAIL PRICE
29711	CD/CE/RA/YA	F-Series	\$115.99
29620	BB/CD/CE/RA	F-Series/Man.	\$115.99
29630	BA/BB/CB/CD/CE	F-Series/Man.	\$115.99



**29711**  
(LH)



**29620**  
(RH)



**29630**  
(Rear)

# 1994-1997 HONDA ACCORD

**29753**

CHASSIS	ENGINE / TRANS	KIT TYPE	RETAIL PRICE
CD5/CD7/CE1(EX)	H22/F22A-Swap/Man.	Steel	\$299.99



PART NUMBER	CHASSIS	ENGINE / TRANS	RETAIL PRICE
29711	CD/CE	F/H-Series/Man.	\$115.99
29620	BB/CD/CE/RA	F-Series/Man.	\$115.99
29731	CB/CD/CE	F-Series/Man.	\$115.99



**29711**  
(LH)



**29620**  
(RH)



**29731**  
(Rear)

# 1998-2002 HONDA ACCORD

**20250**

CHASSIS	ENGINE / TRANS	KIT TYPE	RETAIL PRICE
CG3/CG5	F-Series/H-Series(98+)/Man.	Steel	\$349.99



PART NUMBER	CHASSIS	ENGINE / TRANS	RETAIL PRICE
20210	CG	F/H-Series	\$149.99
20210-SB	CG	F-Series/H-Series(98+)	\$34.99
20220	CG	F/H-Series	\$115.99
20230	CG	F/H-Series/Man.	\$124.99



**20210**  
(LH)



**20210-SB**  
(LH)



**20220**  
(RH)



**20230**  
(Rear)

# 1998-2002 HONDA ACCORD

20251

CHASSIS	ENGINE / TRANS	KIT TYPE	RETAIL PRICE
CG3/CG5	F-Series/H-Series(98+)/Auto	Steel	\$349.99



PART NUMBER	CHASSIS	ENGINE / TRANS	RETAIL PRICE
20210	CG	F/H-Series	\$149.99
20210-SB	CG	F-Series/H-Series(98+)	\$34.99
20220	CG	F/H-Series	\$115.99
20231	CG	F/H-Series/Auto	\$124.99



# 1998-2002 HONDA ACCORD

10350

CHASSIS	ENGINE / TRANS	KIT TYPE	RETAIL PRICE
CG1/CG2	J-Series/Auto	Steel	\$349.99



PART NUMBER	CHASSIS	ENGINE / TRANS	RETAIL PRICE
10320	CG/UA/YA	J-Series	\$119.99
10330	CG/UA/YA	J-Series/Auto	\$119.99
10340	CG/RL/UA/YA/YD/YF/YK	J-Series	\$115.00



# 1998-2002 HONDA ACCORD

20252

CHASSIS	ENGINE / TRANS	KIT TYPE	RETAIL PRICE
CG3/CG5	H-Swap(-97)/Man.	Steel	\$349.99



PART NUMBER	CHASSIS	ENGINE / TRANS	RETAIL PRICE
20210	CG	F/H-Series	\$149.99
20211-SB	CG	H-Series(-97)	\$34.99
20220	CG	F/H-Series	\$115.99
20230	CG	F/H-Series/Man.	\$124.99



# 1998-2002 HONDA ACCORD

20253

CHASSIS	ENGINE / TRANS	KIT TYPE	RETAIL PRICE
CG3/CG5	H-Swap(-97)Auto	Steel	\$349.99



PART NUMBER	CHASSIS	ENGINE / TRANS	RETAIL PRICE
20210	CG	F/H-Series	\$149.99
20211-SB	CG	H-Series/(-97)	\$34.99
20220	CG	F/H-Series	\$115.99
20231	CG	H-Series/Auto	\$124.99



# 2003-2007 HONDA ACCORD

PM10750/10750

CHASSIS	ENGINE / TRANS	KIT TYPE	RETAIL PRICE
CM6/CM8	J-Series	Billet	\$549.99
CM6/CM8	J-Series	Steel	\$349.99



PART NUMBER	CHASSIS	ENGINE / TRANS	RETAIL PRICE
PM10720	CL/CM/UA	J-Series	\$184.99
PM10730	CL/CM/KB/RL/UA/YD	J-Series	\$184.99
PM10740	CM/KB/RL/UA/YD	J-Series	\$184.99
10720	CL/CM/UA	J/K-Series	\$175.00
10720-SB	CM/UA	J-Series	\$50.00
B10720	CM/UA	J-Series	\$75.00
10730	CL/CM/KB/RL/UA/YD	J-Series	\$124.99
10740	CM/KB/RL/UA/YB/YD	J-Series	\$124.99



# 2003-2007 HONDA ACCORD

10751

CHASSIS	ENGINE / TRANS	KIT TYPE	RETAIL PRICE
CM7/CM5	K-Series	Steel	\$399.99



PART NUMBER	CHASSIS	ENGINE / TRANS	RETAIL PRICE
10720	CL/CM/UA	J/K-Series	\$175.00
10721-SB	CL/CM	K-Series	\$50.00
B10721	CL/CM	K-Series	\$75.00
10731	CL/CM	K-Series	\$129.99
10741	CL/CM	K-Series	\$124.99



# 2008-2012 HONDA ACCORD

**29850**

CHASSIS	ENGINE / TRANS	KIT TYPE	RETAIL PRICE
CP3/CS2	J-Series/Man.	Steel	\$349.99

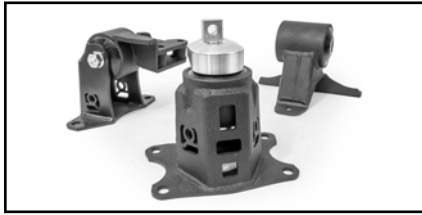

PART NUMBER	CHASSIS	ENGINE / TRANS	RETAIL PRICE
29820	CP/CS/CU	J-Series	\$124.99
29820-SB	CP/CS/CU	J-Series	\$99.99
29830	CP/CS/CU	J-Series/Man.	\$124.99
29840	CP/CS/CU	J-Series/Man.	\$124.99



# 2013-2017 HONDA ACCORD

**11750**

CHASSIS	ENGINE / TRANS	KIT TYPE	RETAIL PRICE
CT1/CR2	J-Series/Man.	Steel	\$399.99



PART NUMBER	CHASSIS	ENGINE / TRANS	RETAIL PRICE
11720-A	CT1/CR2	J-Series	\$124.99
11720-SB	CT1/CR2	J-Series	\$99.99
11730	CT1/CR2	J-Series/Man.	\$124.99
29840	CP/CS/CU/CT/CR	J-Series/Man.	\$124.99



# 1988-1991 HONDA PRELUDE

**29151**

CHASSIS	ENGINE / TRANS	KIT TYPE	RETAIL PRICE
BA	B-Series/Man.	Steel	\$199.99



PART NUMBER	CHASSIS	ENGINE / TRANS	RETAIL PRICE
29111	BA	B-Series/Man.	\$115.99
29121	BA	B-Series/Man.	\$115.99
29630	BA	B-Series/Man.	\$115.99



# 1988-1991 HONDA PRELUDE

**29152**

CHASSIS	ENGINE / TRANS	KIT TYPE	RETAIL PRICE
BA	H-Swap/Man.	Steel	\$399.99



PART NUMBER	CHASSIS	ENGINE / TRANS	RETAIL PRICE
29112	BA	H-Series/Man.	\$149.99
29112-SB	BA	H-Series/Man.	\$34.99
29122	BA	H-Series/Man.	\$119.99
29122-SB	BA	H-Series/Man.	\$49.99
29631	BA	H-Series/Man.	\$115.99



# 1992-1996 HONDA PRELUDE

**29650**

CHASSIS	ENGINE / TRANS	KIT TYPE	RETAIL PRICE
BA/BB	F/H-Series/Man./Auto2Man.	Steel	\$299.99



PART NUMBER	CHASSIS	ENGINE / TRANS	RETAIL PRICE
29610	BB	F/H-Series	\$115.99
29620	BB/CD/CE/RA	F-Series/Man.	\$115.99
29630	BA/BB/CD/CE	B/F/H-Series	\$124.99



# 1992-1996 HONDA PRELUDE

**29651**

CHASSIS	ENGINE / TRANS	KIT TYPE	RETAIL PRICE
BA/BB	F/H-Series/Auto	Steel	\$299.99



PART NUMBER	CHASSIS	ENGINE / TRANS	RETAIL PRICE
29610	BB	F/H-Series	\$115.99
29322	BB/CB	F-Series	\$119.99
29630	BA/BB/CD/CE	B/F/H-Series	\$124.99



# 1997-2001 HONDA PRELUDE

**20150**

CHASSIS	ENGINE / TRANS	KIT TYPE	RETAIL PRICE
BB	F/H-Series	Steel	\$299.99



PART NUMBER	CHASSIS	ENGINE / TRANS	RETAIL PRICE
20110	BB	F/H-Series	\$149.99
20110-SB	BB	F/H-Series	\$50.00
20120	BB	F/H-Series	\$115.99
29631	BB	F/H-Series	\$115.99



# 1997-2001 HONDA PRELUDE

**80152**

CHASSIS	ENGINE / TRANS	KIT TYPE	RETAIL PRICE
BB	J-Swap/Man.	Steel	\$499.99



PART NUMBER	CHASSIS	ENGINE / TRANS	RETAIL PRICE
80010	BB/EK/EJ	J-Series/EG subframe/Man.	\$119.99
80112-SB	BB	J-Series/Man.	\$60.00
80122	BB	J-Series/Man.	\$119.99
80122-SB	BB	J-Series/Man.	\$49.99
80132	BB/EG/EH/EJ/DC	J-Series/Man.	\$49.99
80132-SB	BB/EG/EH/EJ/DC	J-Series/Man.	\$49.99



# 2007-2008 HONDA FIT/JAZZ

**10850**

CHASSIS	ENGINE / TRANS	KIT TYPE	RETAIL PRICE
GD	L-Series/Man.	Steel	\$349.99



PART NUMBER	CHASSIS	ENGINE / TRANS	RETAIL PRICE
10810	GD	L-Series/Man.	\$119.99
10820	GD	L-Series	\$119.99
10820-SB	GD	L-Series	\$34.99
10830	GD	L-Series	\$119.99



# 2007-2008 HONDA FIT/JAZZ

**10851**

CHASSIS	ENGINE / TRANS	KIT TYPE	RETAIL PRICE
GD	L-Series/Auto	Steel	\$349.99



PART NUMBER	CHASSIS	ENGINE / TRANS	RETAIL PRICE
10811	GD	L-Series/Auto	\$119.99
10820	GD	L-Series	\$119.99
10820-SB	GD	L-Series	\$34.99
10830	GD	L-Series	\$119.99



# 2009-2013 HONDA FIT/JAZZ

**10950**

CHASSIS	ENGINE / TRANS	KIT TYPE	RETAIL PRICE
GE	L-Series/Man.	Steel	\$349.99



PART NUMBER	CHASSIS	ENGINE / TRANS	RETAIL PRICE
10910	GE	L-Series/Man.	\$119.99
10920	GE	L-Series/Man.	\$119.99
10930	GE	L-Series	\$149.99



# 2000-2006 HONDA INSIGHT

**90751**

CHASSIS	ENGINE / TRANS	KIT TYPE	RETAIL PRICE
ZE	K20-Swap/Man.	Steel	\$499.99



PART NUMBER	CHASSIS	ENGINE / TRANS	RETAIL PRICE
90711	ZE	K-Series/Man.	\$119.99
90711-SB	ZE	K-Series/Man.	\$49.99
90721	ZE	K20/Man.	\$119.99
90721-SB	ZE	K20/Man.	\$119.99
90731	ZE	K-Series/Man.	\$124.99



# 2000-2006 HONDA INSIGHT

**90752**

CHASSIS	ENGINE / TRANS	KIT TYPE	RETAIL PRICE
ZE	K20-Swap/Auto2Man.	Steel	\$499.99



PART NUMBER	CHASSIS	ENGINE / TRANS	RETAIL PRICE
90712	ZE	K-Series/Auto2Man.	\$119.99
90712-SB	ZE	K-Series/Auto2Man.	\$49.99
90721	ZE	K20/Man.	\$119.99
90721-SB	ZE	K20/Man.	\$119.99
90731	ZE	K-Series/Man.	\$124.99



# 2000-2006 HONDA INSIGHT

**90753**

CHASSIS	ENGINE / TRANS	KIT TYPE	RETAIL PRICE
ZE	K24-Swap/Man.	Steel	\$499.99



PART NUMBER	CHASSIS	ENGINE / TRANS	RETAIL PRICE
90711	ZE	K-Series/Man.	\$119.99
90711-SB	ZE	K-Series/Man.	\$49.99
90722	ZE	K24/Man.	\$119.99
90722-SB	ZE	K24/Man.	\$100.00
90731	ZE	K-Series/Man.	\$124.99

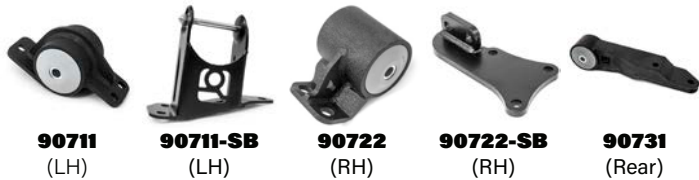

# 2000-2006 HONDA INSIGHT

**90754**

CHASSIS	ENGINE / TRANS	KIT TYPE	RETAIL PRICE
ZE	K24-Swap/Auto2Man.	Steel	\$499.99



PART NUMBER	CHASSIS	ENGINE / TRANS	RETAIL PRICE
90712	ZE	K-Series/Auto2Man.	\$119.99
90712-SB	ZE	K-Series/Auto2Man.	\$49.99
90722	ZE	K24/Man.	\$119.99
90722-SB	ZE	K24/Man.	\$100.00
90731	ZE	K-Series/Man.	\$124.99

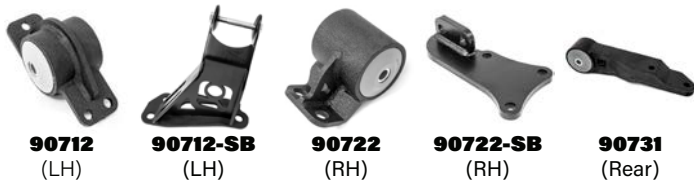



## 2000-2009 HONDA \$2000

## B90750 / 90750

CHASSIS	ENGINE / TRANS	KIT TYPE	RETAIL PRICE
AP	F-Series/Man.	Billet	\$299.99
AP	F-Series/Man.	Steel	\$349.99



PART NUMBER	CHASSIS	ENGINE / TRANS	RETAIL PRICE
B90710	AP	F-Series	\$149.99
B90720	AP	F-Series/Man.	\$149.99
90710-SB(x2)	AP	F/K-Series	\$30.00
90710	AP	F-Series	\$115.00
90710-SB(x2)	AP	F/K-Series	\$30.00
90720	AP	F-Series/Man.	\$149.99
90730	AP	F-Series/Man.	\$149.99
90730-SB	AP	F-Series	\$34.99



## 2000-2009 HONDA \$2000

## B90755 / 90755

CHASSIS	ENGINE / TRANS	KIT TYPE	RETAIL PRICE
AP	F-Series/Differential/Man.	Billet	\$249.99
AP	F-Series/Differential/Man.	Steel	\$174.99

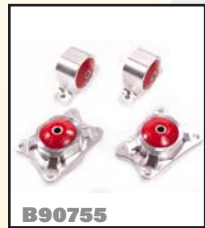

PART NUMBER	CHASSIS	ENGINE / TRANS	RETAIL PRICE
B90755L	AP	F-Series/Man.	\$129.99
B90755R	AP	F-Series/Man.	\$129.99
B90755C	AP	F-Series/Man.	\$129.99
90755A	AP	F-Series/Man.	\$104.99
90755L	AP	F-Series/Man.	\$119.99
90755R	AP	F-Series/Man.	\$119.99



## 2000-2009 HONDA \$2000

## 90758

CHASSIS	ENGINE / TRANS	KIT TYPE	RETAIL PRICE
AP	K-Swap/Man./OEM Positioning	Steel	\$349.99



PART NUMBER	CHASSIS	ENGINE / TRANS	RETAIL PRICE
90716	AP	K-Series/Man.	\$129.99
90710-SB	AP	F/K-Series	\$30.00
90726	AP	K-Series	\$129.99
90730	AP	F/K-Series	\$149.99
90730	AP	F/K-Series	\$34.99



## 2000-2009 HONDA S2000

**90756**

CHASSIS	ENGINE / TRANS	KIT TYPE	RETAIL PRICE
AP	K20-Swap/Man./Adapter Plate	Steel	\$399.99



PART NUMBER	CHASSIS	ENGINE / TRANS	RETAIL PRICE
90723	AP	K-Series	\$119.99
90723-SB	AP	K-Series	\$49.99
90730	AP	K/F-Series	\$149.99
90730-SB	AP	K-Series	\$34.99
90743-K20	AP	K20/Man.	\$115.00
90743-SB	AP	K-Series	\$119.99



## 2000-2009 HONDA S2000

**90757**

CHASSIS	ENGINE / TRANS	KIT TYPE	RETAIL PRICE
AP	K24-Swap/Man./Adapter Plate	Steel	\$399.99



PART NUMBER	CHASSIS	ENGINE / TRANS	RETAIL PRICE
90723	AP	K-Series	\$119.99
90723-SB	AP	K-Series	\$49.99
90730	AP	K/F-Series	\$149.99
90730-SB	AP	K-Series	\$34.99
90743-K24	AP	K20/Man.	\$115.00
90743-SB	AP	K-Series	\$119.99



## 2012-2015 HONDA CR-Z

**11550**

CHASSIS	ENGINE / TRANS	KIT TYPE	RETAIL PRICE
ZF	L-Series/CVT	Steel	\$349.99



PART NUMBER	CHASSIS	ENGINE / TRANS	RETAIL PRICE
11510	ZF	L-Series/Man./CVT	\$124.99
11520	ZF	L-Series/Man./CVT	\$124.99
11530	ZF	L-Series/Man./CVT	\$99.99



# 1995-1998 HONDA ODYSSEY

**29755**

CHASSIS	ENGINE / TRANS	KIT TYPE	RETAIL PRICE
RA	H22/F22A/Auto	Steel	\$299.99



PART NUMBER	CHASSIS	ENGINE / TRANS	RETAIL PRICE
29710	CD/CE/RA	F/H-Series	\$115.99
29322	BA/CB/CD/RA	F-Series/Auto	\$119.99
29332	CB/CD/CE/RA	F-Series/Auto	\$115.99



# 1995-1998 HONDA ODYSSEY

**29756**

CHASSIS	ENGINE / TRANS	KIT TYPE	RETAIL PRICE
RA	F-Series/Auto	Steel	\$299.99



PART NUMBER	CHASSIS	ENGINE / TRANS	RETAIL PRICE
29711	CD/CE/RA/YA	F-Series	\$115.99
29322	BA/CB/CD/RA	F-Series/Auto	\$119.99
29332	CB/CD/CE/RA	F-Series/Auto	\$115.99



# 1995-1998 HONDA ODYSSEY

**29758**

CHASSIS	ENGINE / TRANS	KIT TYPE	RETAIL PRICE
RA	H-Swap/Auto2Man.	Steel	\$299.99



PART NUMBER	CHASSIS	ENGINE / TRANS	RETAIL PRICE
29710	CD/CE/RA	F/H-Series	\$115.99
29324	BB/CB/CD/CE/RA	F/H-Series/Auto2Man.(94-01 Trans.)	\$119.99
29630	BA/BB/CD/CE/RA	B/F/H-Series/Man.	\$115.99



# 1995-1998 HONDA ODYSSEY

**29950**

CHASSIS	ENGINE / TRANS	KIT TYPE	RETAIL PRICE
RA	F-Swap/Auto2Man.	Steel	\$299.99



PART NUMBER	CHASSIS	ENGINE / TRANS	RETAIL PRICE
29711	CD/CE/RA	F-Series	\$115.99
29324	BB/CB/CD/CE/RA	F/H-Series/Auto2Man.(94-01 Trans.)	\$119.99
29630	BA/BB/CB/CD/CE/RA	B/F/H-Series/Man.	\$115.99



# 2002-2006 ACURA RSX

**B90650 / 90650**

CHASSIS	ENGINE / TRANS	KIT TYPE	RETAIL PRICE
DC5	K-Series/Man.	Billet	\$384.99
DC5	K-Series/Man.	Steel	\$299.99

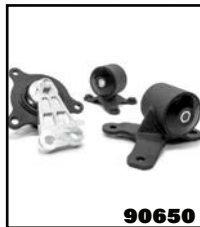
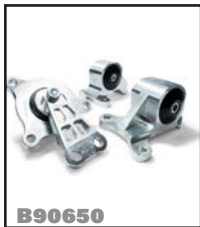

PART NUMBER	CHASSIS	ENGINE / TRANS	RETAIL PRICE
B90610	DC5/EP3/RD/YH	K-Series/Man.	\$149.99
B90620	DC5/EP3/RD/YH	K-Series	\$159.99
B90621	DC5/EP3/RD/YH	K-Series	\$149.99
B90630	DC5/EP3	K-Series	\$149.99
90610	DC5/EP3/RD/YH	K-Series/Man.	\$115.99
90620	DC5/EP3/RD/YH	K-Series	\$149.99
B90621	DC5/EP3/RD/YH	K-Series	\$54.99
90630	DC5/EP3/RD/YH	K-Series	\$115.99



# 2002-2006 ACURA RSX

**90651**

CHASSIS	ENGINE / TRANS	KIT TYPE	RETAIL PRICE
DC5	K-Series/Auto	Steel	\$299.99



PART NUMBER	CHASSIS	ENGINE / TRANS	RETAIL PRICE
90611	DC5/EP3	K-Series/Auto	\$129.99
90620	DC5/EP3/RD/YH	K-Series	\$149.99
B90621	DC5/EP3/RD/YH	K-Series	\$54.99
90630	DC5/EP3/RD/YH	K-Series	\$115.99



# 2002-2006 ACURA RSX

**90652**

CHASSIS	ENGINE / TRANS	KIT TYPE	RETAIL PRICE
DC5	K-Series/Auto2Man.	Steel	\$499.99



PART NUMBER	CHASSIS	ENGINE / TRANS	RETAIL PRICE
90611	DC5/EP3	K-Series/Auto	\$129.99
40610-SB	DC5/EP3	K-Series/Auto2Man	\$114.99
90620	DC5/EP3/RD/YH	K-Series	\$149.99
B90621	DC5/EP3/RD/YH	K-Series	\$54.99
90630	DC5/EP3/RD/YH	K-Series	\$115.99



# 1990-1993 ACURA INTEGRA

**B19350 / 19350**

CHASSIS	ENGINE / TRANS	KIT TYPE	RETAIL PRICE
DA9(90-91)/DB2(92-93)	B-Series/GSR/Man./Cable	Billet	\$299.99
DA9(90-91)/DB2(92-93)	B-Series/GSR/Man./Cable	Steel	\$249.99



PART NUMBER	CHASSIS	ENGINE / TRANS	RETAIL PRICE
B19310	DA/DB/ED/EE/EF	B-Series	\$139.99
B19320	AF/AH/DA/DB/EC	B-Series/Man./Cable	\$149.99
B19330	DA/DB	B-Series/Man.	\$149.99
19310	DA/DB/ED/EE/EF	B-Series	\$99.99
19320	AF/AH/DA/DB/EC	B-Series/Man./Cable	\$119.99
19330	DA/DB	B-Series/Man.	\$119.99



# 1990-1993 ACURA INTEGRA

**19353**

CHASSIS	ENGINE / TRANS	KIT TYPE	RETAIL PRICE
DA9(90-91)/DB2(92-93)	B-Series/GSR/Auto/Hydro	Steel	\$249.99



PART NUMBER	CHASSIS	ENGINE / TRANS	RETAIL PRICE
19310	DA/ED/EE/EF	B-Series	\$99.99
19321	DA	B-Series/Auto/Hydro	\$79.99
19330	DA/DB	B-Series/Man.	\$119.99



# 1990-1993 ACURA INTEGRA

**49350**

CHASSIS	ENGINE / TRANS	KIT TYPE	RETAIL PRICE
DA9(90-91)/DB2(92-93)	B-Series/GSR/Man./Hydro/Cable2Hydro	Steel	\$349.99



PART NUMBER	CHASSIS	ENGINE / TRANS	RETAIL PRICE
19310	DA/ED/EE/EF	B-Series	\$99.99
49320	DA/DB	B-Series/Man./Hydro/Cable2Hydro	\$129.99
19330	DA/DB	B-Series/Man.	\$119.99
41000	DA/DB/ED/EE/EF	B-Series	\$149.99



# 1992-1993 ACURA INTEGRA

**B19351 / 19351**

CHASSIS	ENGINE / TRANS	KIT TYPE	RETAIL PRICE
DA9(92-93)/DB1(92-93)	B18A1/Man./Cable	Billet	\$299.99
DA9(92-93)/DB1(92-93)	B18A1/Man./Cable	Steel	\$249.99



PART NUMBER	CHASSIS	ENGINE / TRANS	RETAIL PRICE
B19311	DA/DB	B-Series	\$139.99
B19320	AF/AH/DA/DB/EC	B-Series/Man./Cable	\$149.99
B19330	DA/DB	B-Series/Man.	\$149.99
19311	DA/DB	B-Series	\$99.99
19320	AF/AH/DA/DB/EC	B-Series/Man./Cable	\$119.99
19330	DA/DB	B-Series/Man.	\$119.99



# 1992-1993 ACURA INTEGRA

**49351**

CHASSIS	ENGINE / TRANS	KIT TYPE	RETAIL PRICE
DA9(92-93)/DB1(92-93)	B18A1/Man./Cable2Hydro	Steel	\$349.99



PART NUMBER	CHASSIS	ENGINE / TRANS	RETAIL PRICE
19311	DA/DB	B-Series	\$99.99
49320	DA/DB	B-Series/Man./Hydro/Cable2Hydro	\$129.99
19330	DA/DB	B-Series/Man.	\$119.99
41000	DA/DB/ED/EE/EF	B-Series	\$149.99



	NAME	SIGNATURE	DATE	TITLE
DRAWN				
CHK'D				
APPV'D				
MFG				
MATERIAL				DWG NO.

# 1992-1993 ACURA INTEGRA

**49354**

CHASSIS	ENGINE / TRANS	KIT TYPE	RETAIL PRICE
DA9(92-93)/DB1(92-93)	B-Series/Auto2Man./Cable	Steel	\$249.99



PART NUMBER	CHASSIS	ENGINE / TRANS	RETAIL PRICE
19311	DA/DB	B-Series	\$99.99
49321	DA/DB	B-Series/Man./Auto2Man./Cable	\$129.99
19330	DA/DB	B-Series/Man.	\$119.99



**19311**  
(LH)

**49321**  
(RH)

**19330**  
(Rear)

# 1990-1993 ACURA INTEGRA

**29354**

CHASSIS	ENGINE / TRANS	KIT TYPE	RETAIL PRICE
DA/DB	F/H-Swap/Man.	Steel	\$399.99



PART NUMBER	CHASSIS	ENGINE / TRANS	RETAIL PRICE
29311	DA/DB	F/H-Series	\$115.99
29320	DA/DB/CB	H-Series/F-Series(94-01 Trans.)	\$115.99
29321-SB	DA/DB	F/H-Series/Man.	\$59.99
29334	DA/DB	F/H-Series	\$125.00
41003	DA/DB	F/H-Series	\$149.99



**29311**  
(LH)

**29320**  
(RH)

**29321-SB**  
(RH)

**29334**  
(Rear)

**41003**  
(Actuator)

NOTE:  
ORIENTATION OF SPLIT WASHER  
IS **DOWN**

# 1990-1993 ACURA INTEGRA

**99351**

CHASSIS	ENGINE / TRANS	KIT TYPE	RETAIL PRICE
DA9(90-91)/DB2(92-93)	K-Swap/GSR/Man./Auto2Man.	Steel	\$429.99



PART NUMBER	CHASSIS	ENGINE / TRANS	RETAIL PRICE
99310	DA/DB	K-Series	\$124.99
99320	DA/DB	K-Series	\$119.99
99320-SB	DA/DB	K-Series	\$69.99
99330	DA/DB	K-Series/Man.	\$149.99
99130-SB	DA/DB	K-Series/Man.	\$50.00



**99310**  
(LH)

**99320**  
(RH)

**99320-SB**  
(RH)

**99330**  
(Rear)

**99130-SB**  
(Rear)

ITEM NO.	PART NUMBER	QTY
1	81540A	
2	81540B	
3	81540C	1
4	RS1-263	1
5	CP1-300	1
6	SW1-125	2

# 1994-2001 ACURA INTEGRA

# B10150 / 10150

CHASSIS	ENGINE / TRANS	KIT TYPE	RETAIL PRICE
DB/DC	B/D-Series/Man./Hydro/H2B/3 Bolt Post	Billet	\$299.99
DB/DC	B/D-Series/Man./Hydro/H2B/3 Bolt Post	Steel	\$269.99



PART NUMBER	CHASSIS	ENGINE / TRANS	RETAIL PRICE
B10110	DC/EG/EH/EJ	B/D-Series/3 Bolt Post	\$149.99
B10120	DC/EG/EH/EJ	B/D-Series/Man./Hydro	\$139.99
B10130	DC/EG/EH/EJ	B/D-Series/Man./Hydro	\$149.99
10110	DC/EG/EH/EJ	B/D-Series/Man./Hydro	\$115.00
10120	DC/EG/EH/EJ	B/D-Series/Man./Hydro	\$139.99
10130	DC/EG/EH/EJ	B/D-Series/Man./Hydro	\$115.99



# 1994-2001 ACURA INTEGRA

# B19550 / 19550

CHASSIS	ENGINE / TRANS	KIT TYPE	RETAIL PRICE
DB/DC	B/D-Series/Man./Hydro/2 Bolt Post	Billet	\$299.99
DB/DC	B/D-Series/Man./Hydro/2 Bolt Post	Steel	\$269.99



PART NUMBER	CHASSIS	ENGINE / TRANS	RETAIL PRICE
B19510	DC/EG/EH/EJ	B/D-Series/2 Bolt Post	\$135.00
B10120	DC/EG/EH/EJ	B/D-Series/Man./Hydro	\$139.99
B10130	DC/EG/EH/EJ	B/D-Series/Man./Hydro	\$149.99
19510	DC/EG/EH/EJ	B/D-Series/2 Bolt Post	\$115.00
10120	DC/EG/EH/EJ	B/D-Series/Man./Hydro	\$139.99
10130	DC/EG/EH/EJ	B/D-Series/Man./Hydro	\$115.99



# 1994-2001 ACURA INTEGRA

# 40153

CHASSIS	ENGINE / TRANS	KIT TYPE	RETAIL PRICE
DB/DC	B/D-Series/Auto/Hydro/3 Bolt Post	Steel	\$269.99



PART NUMBER	CHASSIS	ENGINE / TRANS	RETAIL PRICE
10110	EG/EH/EJ/DC	B/D-Series/Auto/3 Bolt Post	\$115.00
10121	EG/EH/EJ/DC	B/D-Series/Auto	\$115.00
10130	EG/EH/EJ/EK/EM/DC/MB	B/D-Series	\$119.99





# 1994-2001 ACURA INTEGRA

**40156**

CHASSIS	ENGINE / TRANS	KIT TYPE	RETAIL PRICE
DB/DC	B/D-Series/Auto/Hydro/2 Bolt Post	Steel	\$269.99



PART NUMBER	CHASSIS	ENGINE / TRANS	RETAIL PRICE
19510	EG/EH/EJ/DC	B/D-Series	\$115.00
10121	EG/EH/EJ/EC	B/D-Series/Auto	\$115.00
10130	EG/EH/EJ/EK/EM/EN/DC	B/D-Series/Man./Auto	\$115.99

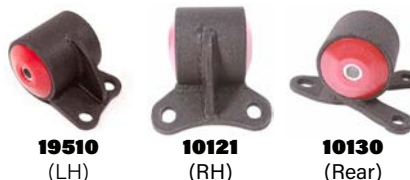

# 1994-2001 ACURA INTEGRA

**40150**

CHASSIS	ENGINE / TRANS	KIT TYPE	RETAIL PRICE
DB/DC	B/D-Swap/Man./Hydro2Cable/3 Bolt Post	Steel	\$299.99



PART NUMBER	CHASSIS	ENGINE / TRANS	RETAIL PRICE
10110	EG/EH/EJ/DC	B/D-Series/Auto/3 Bolt Post	\$115.00
40120	EG/EH/EJ/DC	B/D-Series/Hydro2Cable	\$149.99
40120-SB	EG/EH/EJ/DC	B/D-Series/Hydro2Cable	\$50.00
10130	EG/EH/EJ/EK/EM/DC/MB	B/D-Series	\$115.99



# 1994-2001 ACURA INTEGRA

**49553**

CHASSIS	ENGINE / TRANS	KIT TYPE	RETAIL PRICE
DB/DC	B/D-Swap/Man./Hydro2Cable/2 Bolt Post	Steel	\$299.99



PART NUMBER	CHASSIS	ENGINE / TRANS	RETAIL PRICE
19510	EG/EH/EJ/DC	B/D-Series/Auto/2 Bolt Post	\$115.00
40120	EG/EH/EJ/DC	B/D-Series/Hydro2Cable	\$149.99
40120-SB	EG/EH/EJ/DC	B/D-Series/Hydro2Cable	\$50.00
10130	EG/EH/EJ/EK/EM/DC/MB	B/D-Series	\$115.99



# 1994-2001 ACURA INTEGRA

# B40154 / 40154

CHASSIS	ENGINE / TRANS	KIT TYPE	RETAIL PRICE
DB/DC	B/D-Series/Auto2Man./Hydro/3 Bolt Post	Billet	\$299.99
DB/DC	B/D-Series/Auto2Man./Hydro/3 Bolt Post	Steel	\$269.99



PART NUMBER	CHASSIS	ENGINE / TRANS	RETAIL PRICE
B10110	DC/EG/EH/EJ	B/D-Series/3 Bolt Post	\$149.99
B40121	DC/EG/EH/EJ	B/D-Series/Auto2Man.	\$149.99
B10130	DC/EG/EH/EJ	B/D-Series/Man./Hydro	\$149.99
10110	DC/EG/EH/EJ	B/D-Series/Man./Hydro	\$115.00
40121	DC	B/D-Series/Auto2Man.	\$129.99
10130	DC/EG/EH/EJ	B/D-Series/Man./Hydro	\$115.99



# 1994-2001 ACURA INTEGRA

# 49551

CHASSIS	ENGINE / TRANS	KIT TYPE	RETAIL PRICE
DC2	B/D-Series/Auto2Man./Hydro/2 Bolt Post	Steel	\$269.99



PART NUMBER	CHASSIS	ENGINE / TRANS	RETAIL PRICE
19510	DC/EG/EH/EJ	B/D-Series	\$115.00
40121	DC	B-Series/Auto2Man./Hydro	\$129.99
10130	EG/EH/EJ/EK/EM/DC/MB	B/D-Series	\$119.99



# 1994-2001 ACURA INTEGRA

# 40155

CHASSIS	ENGINE / TRANS	KIT TYPE	RETAIL PRICE
DB/DC	B/D-Series/Auto2Man./Cable	Steel	\$269.99



PART NUMBER	CHASSIS	ENGINE / TRANS	RETAIL PRICE
10110	EG/EH/EJ/DC	B/D-Series/Auto/3 Bolt Post	\$115.00
40122	DC	B-Series/Auto2Man.	\$150.00
10130	EG/EH/EJ/EK/EM/EN/DC	B/D-Series/Man./Auto	\$115.99



# 1994-2001 ACURA INTEGRA

# B90150 / 90150

CHASSIS	ENGINE / TRANS	KIT TYPE	RETAIL PRICE
DB/DC	K-Swap/Man./Auto2Man.	Billet	\$499.99
DB/DC	K-Swap/Man./Auto2Man.	Steel	\$429.99

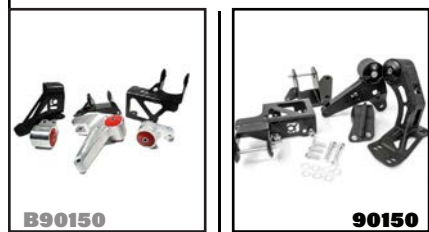

PART NUMBER	CHASSIS	ENGINE / TRANS	RETAIL PRICE
B10110	DB/DC/EG/EH/EJ	B/D/K-Series/3 Bolt Post	\$149.00
B90110-SB	DB/DC/EG/EH/EJ	K-Series	\$149.99
B90120	DB/DC/EG/EH/EJ	K-Series	\$115.99
90120-SB	DB/DC/EG/EH/EJ	K-Series/Auto2Man.	\$80.00
B90130	DB/DC/EG/EH/EJ	K-Series/Man.	\$164.99
90130-SB	DB/DC	K-Series	\$50.00
90110	DB/DC	K-Series/Man.	\$115.00
90120	CB/DB/DC/FB/FG	K-Series	\$129.99
90120-SB	DB/DC/EG/EH/EJ	K-Series/Man./Auto2Man.	\$80.00
90130	DB/DC/EG/EH/EJ	K-Series/Man.	\$159.99
90130-SB	DB/DC	K-Series	\$50.00



# 1994-2001 ACURA INTEGRA

# 80150

CHASSIS	ENGINE / TRANS	KIT TYPE	RETAIL PRICE
DB/DC	J-Swap/Man./Hydro	Steel	\$499.99



PART NUMBER	CHASSIS	ENGINE / TRANS	RETAIL PRICE
80110	DC/EG/EH/EJ	J-Swap/Man.	\$119.99
80110-SB	DC/EG/EH/EJ	J-Swap/Man.	\$49.99
80120	DC/EG/EH/EJ/MB/RD	J-Swap	\$119.99
80120-SB	DC/EG/EH/EJ	J-Swap	\$115.99
80130	DC/EG/EH/EJ	J-Swap/Man.	\$124.99
80130-SB	DC/EG/EH/EJ	J-Swap/Man.	\$49.99
80150-SB	DC/EG/EH/EJ	J-Swap	\$149.99



# 1994-2001 ACURA INTEGRA

**B29550 / 29550**

CHASSIS	ENGINE / TRANS	KIT TYPE	RETAIL PRICE
DB/DC	H-Swap/Man./Auto2Man.	Billet	\$364.99
DB/DC	H-Swap/Man./Auto2Man.	Steel	\$299.99



**B29550**



**29550**

PART NUMBER	CHASSIS	ENGINE / TRANS	RETAIL PRICE
B29510	DB/DC/EG/EH/EJ	H-Series	\$115.00
B29520	DB/DC	H-Series/Man./Auto2Man.	\$125.99
29520-SB	DB/DC/EG/EH/EJ	H-Series/Auto2Man.	\$75.00
B29530	DB/DC/EG/EH/EJ	H-Series/Man.	\$115.00
29510	DB/DC/EG/EH/EJ	H-Series	\$115.00
20020	DB/DC/ED/EE/EF/EG/EH/EJ	H-Series/Man./Auto2Man.	\$115.99
29520-SB	DB/DC/EG/EH/EJ	H-Series/Auto2Man.	\$75.00
29530	DB/DC/EG/EH/EJ	H-Series/Man.	\$115.99



# 90-05 ACURA NSX

**80550**

CHASSIS	ENGINE / TRANS	KIT TYPE	RETAIL PRICE
NA	C32/Man.	Steel	\$399.99



PART NUMBER	CHASSIS	ENGINE / TRANS	RETAIL PRICE
80510	NA	C-Series/Man.	\$115.00
80520	NA	C-Series/Man.	\$115.00
80530	NA	C-Series/Man.	\$115.00
80540	NA	C-Series/Man.	\$115.00



# 2004-2008 ACURA TSX

**10751**

CHASSIS	ENGINE / TRANS	KIT TYPE	RETAIL PRICE
CL	K-Series	Steel	\$399.99



PART NUMBER	CHASSIS	ENGINE / TRANS	RETAIL PRICE
10720	CL/CM	J/K-Series	\$175.00
10721-SB	CL/CM	K-Series	\$50.00
B10721	CL/CM	K-Series	\$75.00
10731	CL/CM	K-Series	\$129.99
10741	CL/CM	K-Series	\$124.99



# 2010-2014 ACURA TSX

# PM10750/10750

CHASSIS	ENGINE / TRANS	KIT TYPE	RETAIL PRICE
CM6/CM8	J-Series	Billet	\$549.99
CM6/CM8	J-Series	Steel	\$349.99



PART NUMBER	CHASSIS	ENGINE / TRANS	RETAIL PRICE
PM10723	CL/CM/UA	J-Series	\$184.99
PM10730	CL/CM/KB/RL/UA/YD	J-Series	\$184.99
PM10740	CM/KB/RL/UA/YD	J-Series	\$184.99
10720	CL/CM/UA	J/K-Series	\$175.00
10720-SB	CM/UA	J-Series	\$50.00
B10720	CM/UA	J-Series	\$75.00
10730	CL/CM/KB/RL/UA/YD	J-Series	\$124.99
10740	CM/KB/RL/UA/YB/YD	J-Series	\$124.99



# 2004-2008 ACURA TL

# PM10750/10750

CHASSIS	ENGINE / TRANS	KIT TYPE	RETAIL PRICE
UA	J-Series	Billet	\$549.99
UA	J-Series	Steel	\$349.99



PART NUMBER	CHASSIS	ENGINE / TRANS	RETAIL PRICE
PM10723	CL/CM/UA	J-Series	\$184.99
PM10730	CL/CM/KB/RL/UA/YD	J-Series	\$184.99
PM10740	CM/KB/RL/UA/YD	J-Series	\$184.99
10720	CL/CM/UA	J/K-Series	\$175.00
10720-SB	CM/UA	J-Series	\$50.00
B10720	CM/UA	J-Series	\$75.00
10730	CL/CM/KB/RL/UA/YD	J-Series	\$124.99
10740	CM/KB/RL/UA/YB/YD	J-Series	\$124.99



# 1997-1999 ACURA CL

**29756**

CHASSIS	ENGINE / TRANS	KIT TYPE	RETAIL PRICE
YA	F-Series/Auto	Steel	\$299.99



PART NUMBER	CHASSIS	ENGINE / TRANS	RETAIL PRICE
29711	CD/CE/RA/YA	F-Series	\$115.99
29322	BA/CB/CD/RA	F-Series/Auto	\$119.99
29332	CB/CD/CE/RA	F-Series/Auto	\$115.99



# 1997-1999 ACURA CL

**29759**

CHASSIS	ENGINE / TRANS	KIT TYPE	RETAIL PRICE
YA	H23/F20B/Auto2Man.	Steel	\$299.99



PART NUMBER	CHASSIS	ENGINE / TRANS	RETAIL PRICE
29711	CD/CE/RA/YA	F-Series	\$115.99
29325	CD/CE/RA/YA	F-Series	\$119.99
29731	CB/CD	F-Series/Man.	\$115.99



# 2001-2003 ACURA CL

**10350**

CHASSIS	ENGINE / TRANS	KIT TYPE	RETAIL PRICE
YA4	J-Series/Auto	Steel	\$349.99



PART NUMBER	CHASSIS	ENGINE / TRANS	RETAIL PRICE
10320	CG/UA/YA	J-Series	\$119.99
10330	CG/UA/YA	J-Series	\$119.99
10340	CG/UA/YA	J-Series	\$115.00



# 2001-2003 ACURA CL

**10351**

CHASSIS	ENGINE / TRANS	KIT TYPE	RETAIL PRICE
YA4	J-Series/Man.	Steel	\$349.99



PART NUMBER	CHASSIS	ENGINE / TRANS	RETAIL PRICE
10320	CG/UA/YA	J-Series	\$119.99
10331	YA	J-Series/Man.	\$124.99
10340	CG/UA/YA	J-Series	\$115.00



**10320** (RH)      **10331** (Rear)      **10340** (Front)

# 2005-2012 LOTUS ELISE/EXIGE

**60950**

CHASSIS	ENGINE / TRANS	KIT TYPE	RETAIL PRICE
S2	1ZZ-FE/2ZZ-GE/Man.	Steel	\$399.99



PART NUMBER	CHASSIS	ENGINE / TRANS	RETAIL PRICE
60910	S2	1ZZ-FE/Man.	\$115.00
60920	S2	K-Series/1ZZ-FE/Man.	\$119.99
60530	S2/ZZ	L-Series/1ZZ-FE/Man.	\$115.00
60940	S2	1ZZ-FE/Man.	\$15.00



**60910** (LH)      **60920** (RH)      **60530** (Rear)      **60940** (Front)

# 2001-2011 LOTUS ELISE/EXIGE

**90950/90951**

CHASSIS	ENGINE / TRANS	KIT TYPE	RETAIL PRICE
S2	K-Swap/Man.	Chro Tig	\$749.99
S2	K-Swap/Man.	Steel	\$499.99



PART NUMBER	CHASSIS	ENGINE / TRANS	RETAIL PRICE
90910	S2	K-Series/Man.	\$124.99
90910-SB	S2	K-Series/Man.	\$60.00
60920	S2	K-Series/1ZZ-FE	\$119.99
90920-SB	S2	K-Series/Man.	\$29.99
90930	S2	K-Series/Man.	\$119.99
90930-SB	S2	K-Series/Man.	\$50.00



**90910** (LH)      **90910-SB** (LH)      **60920** (RH)      **90920-SB** (RH)      **90930** (Rear)      **90930-SB** (Rear)

# 2012+ LOTUS EXIGES

**61550**

CHASSIS	ENGINE / TRANS	KIT TYPE	RETAIL PRICE
S3	2GR-FE V6/Man.	Steel	\$499.99



PART NUMBER	CHASSIS	ENGINE / TRANS	RETAIL PRICE
61510	S3	2GR-FE	\$139.99
61510-SB	S3	2GR-FE	\$99.99
61420	S1/S3	2GR-FE	\$149.99
61530	S3	2GR-FE	\$149.99
61440	S1/S3	2GR-FE	\$149.99

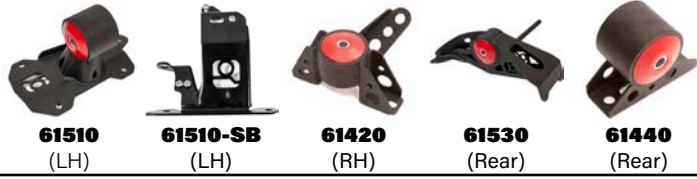

# 2010+ LOTUS EVORA

**61450**

CHASSIS	ENGINE / TRANS	KIT TYPE	RETAIL PRICE
S1	2GR-FE V6/Man.	Steel	\$599.99



PART NUMBER	CHASSIS	ENGINE / TRANS	RETAIL PRICE
61410	S1	2GR-FE	\$149.99
61420	S1/S3	2GR-FE	\$149.99
61430	S1	2GR-FE	\$149.99
61440	S1/S3	2GR-FE	\$149.99



# 1991-1999 MITSUBISHI GTO/3000GT

**79950**

CHASSIS	ENGINE / TRANS	KIT TYPE	RETAIL PRICE
Z16A	6G72	Steel	\$399.99



PART NUMBER	CHASSIS	ENGINE / TRANS	RETAIL PRICE
79910	Z16A	6G72/Man.	\$119.99
79920	Z16A	6G72/Man.	\$119.99
79930	Z16A	6G72/Man.	\$105.00
79940	Z16A	6G72/Man.	\$119.99





# 1995-1999 MITSUBISHI ECLIPSE

**79951**

CHASSIS	ENGINE / TRANS	KIT TYPE	RETAIL PRICE
DSM	4G63/4G64/Man.	Steel	\$299.99



PART NUMBER	CHASSIS	ENGINE / TRANS	RETAIL PRICE
79911	DSM	4G63/4G64	\$109.99
79921	DSM	4G63/4G64	\$109.99
79931	DSM	4G63/4G64	\$105.00



**79911**  
(LH)

**79921**  
(RH)

**79931**  
(Rear)

# 2007-2013 MITSUBISHI LANCER EVO X

**70750**

CHASSIS	ENGINE / TRANS	KIT TYPE	RETAIL PRICE
CZ4A	4B11T/Man.	Steel	\$399.99



PART NUMBER	CHASSIS	ENGINE / TRANS	RETAIL PRICE
70710	CZ4A	4B11T/Man.	\$110.00
70720	CZ4A	4B11T/Man.	\$110.00
70730	CZ4A	4B11T/Man.	\$119.99
70740	CZ4A	4B11T/Man.	\$99.99



**70710**  
(LH)

**70720**  
(RH)

**70730**  
(Rear)

**70740**  
(Front)

# 1991-1995 TOYOTA MR2

**69950**

CHASSIS	ENGINE / TRANS	KIT TYPE	RETAIL PRICE
SW20	3S-GTE/Man.	Steel	\$399.99



PART NUMBER	CHASSIS	ENGINE / TRANS	RETAIL PRICE
69910	SW20	3SGE/3S-GTE/Man.	\$115.00
69920	SW20	3SGE/3S-GTE/Man.	\$115.00
69930	SW20	3SGE/3S-GTE/Man.	\$115.00
69940	SW20	3SGE/3S-GTE/Man.	\$115.00



**69910**  
(LH)

**69920**  
(RH)

**69930**  
(Rear)

**69940**  
(Front)

# 2000-2005 TOYOTA MR2

**60550**

CHASSIS	ENGINE / TRANS	KIT TYPE	RETAIL PRICE
ZZW30	1ZZ-FE/Man.	Steel	\$399.99



PART NUMBER	CHASSIS	ENGINE / TRANS	RETAIL PRICE
60510	ZZ	1ZZ-FE/Man.	\$115.00
60520	ZZ	1ZZ-FE/Man.	\$115.00
60530	ZZ	1ZZ-FE/Man.	\$115.00
60540	ZZ	1ZZ-FE/Man.	\$129.99



# 2007-2013 TOYOTA MR2

**90551**

CHASSIS	ENGINE / TRANS	KIT TYPE	RETAIL PRICE
ZZW30	K-Swap/Man./SMT	Steel	\$499.99



PART NUMBER	CHASSIS	ENGINE / TRANS	RETAIL PRICE
60510	ZZ	1ZZ-FE/Man.	\$115.00
90511-SB	ZZ	1ZZ-FE/Man.	\$59.99
60520	ZZ	1ZZ-FE/Man.	\$115.00
90521-SB	ZZ	1ZZ-FE/Man.	\$30.00
90531	ZZ	1ZZ-FE/Man.	\$125.00
90531-SB	ZZ	1ZZ-FE/Man.	\$49.99



# 2003-2005 DODGE

**30550**

CHASSIS	ENGINE / TRANS	KIT TYPE	RETAIL PRICE
PL	EDV/EDT/Man.	Steel	\$249.99



PART NUMBER	CHASSIS	ENGINE / TRANS	RETAIL PRICE
30510	PL	EDV/EDT/Man.	\$99.99
30520	PL	EDV/EDT/Man.	\$99.99
30530	PL	EDV/EDT/Man.	\$109.99





# Innovative Traction Bars

Our competition and traction bar kits were designed to increase the rigidity and stability of a vehicle's front suspension. Connecting the lower control arms to the chassis reduces that unwanted movement which can increase traction. Special spherical joints allow for the necessary movement without the unwanted slack caused by factory rubber bushings. Great for street cars and suitable racing, these kits can make the difference by helping you put the power to the ground. These products are manufactured with the highest precision and finished in high quality power coat for durability and corrosion resistance. They are also backed by our industry-leading lifetime warranty!



## 88-91 CIVIC/CRX

PART NUMBER	CHASSIS	ENGINE / TRANS	RETAIL PRICE
59111	ED/EE/EF	B/D-Series	\$261.99



## 88-91 CIVIC/CRX

PART NUMBER	CHASSIS	ENGINE / TRANS	RETAIL PRICE
59112	ED/EE/EF(USDM)	B/D-Series	\$330.00



## 88-91 CIVIC/CRX / 90-93 INTEGRA

PART NUMBER	CHASSIS	ENGINE / TRANS	RETAIL PRICE
59311	DA/EE/EF(JDM/EDM)	B/D-Series / RHD	\$330.00



## 92-01 PRELUDE

PART NUMBER	CHASSIS	ENGINE / TRANS	RETAIL PRICE
50110	BB	Works with Many Engines/Trans	\$350.00

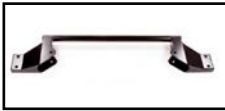

## 97-01 PRELUDE TYPE SH/SIRS

PART NUMBER	CHASSIS	ENGINE / TRANS	RETAIL PRICE
50111	BB	H-Series	\$379.99



## 97-01 PRELUDE TYPE SH/SIRS

PART NUMBER	CHASSIS	ENGINE / TRANS	RETAIL PRICE
50113	BB	J-Series	\$350.00



# Innovative Accessories

Not only do we have a full line of engine mounts and traction bar systems, we also offer vast list of special parts that solve specific issues. From front mount add-ons, replacement OE engine brackets, shift linkages and adapters to throttle cable and AC brackets, we have tons of important parts that can make your life easier! All parts are backed by our industry-leading lifetime warranty!

## Innovative Front Mounts



### 88-91 CIVIC/CRX

PART NUMBER	CHASSIS	ENGINE / TRANS	RETAIL PRICE
19140	ED/EE/EF	B-Series/Cable	\$119.99



### 88-91 CIVIC/CRX

PART NUMBER	CHASSIS	ENGINE / TRANS	RETAIL PRICE
19141	ED/EE/EF	D-Series/Cable	\$119.99



### 88-91 CIVIC/CRX

PART NUMBER	CHASSIS	ENGINE / TRANS	RETAIL PRICE
19142	ED/EE/EF	D-Series/Cable	\$129.99



### 88-91 CIVIC/CRX

PART NUMBER	CHASSIS	ENGINE / TRANS	RETAIL PRICE
19143	ED/EE/EF	B-Series/Cable	\$129.99



### 01-05 CIVIC

PART NUMBER	CHASSIS	ENGINE / TRANS	RETAIL PRICE
10540	EM2/ES1/ES2	D-Series/Manual	\$129.99



## 02-11 CIVIC Si / 02-06 RSX

PART NUMBER	CHASSIS	ENGINE / TRANS	RETAIL PRICE
90640	EP3/FG2/DC5	K-Series	\$126.99



## 92-01 PRELUDE / 94-97 ACCORD

PART NUMBER	CHASSIS	ENGINE / TRANS	RETAIL PRICE
29740	BA/BB/CD/CE/RA	F/H-Series	\$179.99



## 94-97 ACCORD

PART NUMBER	CHASSIS	ENGINE / TRANS	RETAIL PRICE
29741	CD/CE	F-Series	\$114.99



## 98-02 ACCORD

PART NUMBER	CHASSIS	ENGINE / TRANS	RETAIL PRICE
20240	CG	H/F-Series	\$119.99



## 88-91 PRELUDE

PART NUMBER	CHASSIS	ENGINE / TRANS	RETAIL PRICE
29142	BA	F/H-Series	\$179.99



## 92-01 PRELUDE

PART NUMBER	CHASSIS	ENGINE / TRANS	RETAIL PRICE
29640	BA	H-Series	\$115.00



## 97-01 PRELUDE

PART NUMBER	CHASSIS	ENGINE / TRANS	RETAIL PRICE
80140	BB	J-Series	\$149.99



## 90-93 INTEGRA

PART NUMBER	CHASSIS	ENGINE / TRANS	RETAIL PRICE
19144	DA	B-Series/Cable	\$129.99



## 03-10 VIPER

PART NUMBER	CHASSIS	ENGINE / TRANS	RETAIL PRICE
31013	Gen 3/4	8.3L/Man.	\$149.99

## Innovative Accessory Mounts



## MISC.

PART NUMBER	CHASSIS	ENGINE / TRANS	RETAIL PRICE
59185	Misc.	H-Series	\$89.99

H22 Alternator Re Locator



## MISC.

PART NUMBER	CHASSIS	ENGINE / TRANS	RETAIL PRICE
B52050	Misc.	K-Series	\$99.99

K-Series Fuel Rail



## MISC.

PART NUMBER	CHASSIS	ENGINE / TRANS	RETAIL PRICE
41000	Misc.	B-Series	\$149.99

Cable to Hydro Transmission Conversion Actuator



## MISC.

PART NUMBER	CHASSIS	ENGINE / TRANS	RETAIL PRICE
41002	Misc.	D-Series	\$149.99

Cable to Hydro Transmission Conversion Actuator



## MISC.

PART NUMBER	CHASSIS	ENGINE / TRANS	RETAIL PRICE
41003	Misc.	H-Series	\$149.99

Cable to Hydro Transmission Conversion Actuator



## MISC.

PART NUMBER	CHASSIS	ENGINE / TRANS	RETAIL PRICE
41001	Misc.	B/D/H/K-Series	\$249.99

Cable to Hydro Transmission Conversion Actuator



## 88-91 CIVIC

PART NUMBER	CHASSIS	ENGINE / TRANS	RETAIL PRICE
59100	ED/EE/EF	Misc.	\$20.99

Mounts 92-00 Civic Style Radiator



## 88-91 CRX

PART NUMBER	CHASSIS	ENGINE / TRANS	RETAIL PRICE
59101	ED/EE/EF	Misc.	\$20.99

Mounts 92-00 Civic Style Radiator



## 88-91 CIVIC/CRX

PART NUMBER	CHASSIS	ENGINE / TRANS	RETAIL PRICE
59104	ED/EE/EF	92+ Half Style Radiator	\$49.99

Universal Radiator Mounting Brackets



## 88-95 CIVIC/CRX

PART NUMBER	CHASSIS	ENGINE / TRANS	RETAIL PRICE
59510	ED/EF/EJ/EH/EG	B-Series	\$19.99

Throttle Cable Bracket



## 88-91 CIVIC/CRX

PART NUMBER	CHASSIS	ENGINE / TRANS	RETAIL PRICE
59180	ED/EE/EF	B-Series	\$149.99

Sanden Air Conditioning Bracket



## 88-91 CIVIC/CRX

PART NUMBER	CHASSIS	ENGINE / TRANS	RETAIL PRICE
59119	ED/EE/EF	B-Series	\$149.99

B-Series Shift Linkage



## 88-91 CIVIC/CRX / 90-93 INTEGRA

PART NUMBER	CHASSIS	ENGINE / TRANS	RETAIL PRICE
B59350	ED/EE/EF/DA/DB	B-Series	\$99.99

2 Bolt Engine Post Mounting Bracket



## 88-91 CIVIC/CRX / 90-93 INTEGRA

PART NUMBER	CHASSIS	ENGINE / TRANS	RETAIL PRICE
59331	ED/EE/EF/DA	B-Series	\$99.99

Rear Mounting T-Bracket



## 92-00 CIVIC

PART NUMBER	CHASSIS	ENGINE / TRANS	RETAIL PRICE
50018	EG/EH/EJ	B/D-Series	\$150.00

A/C Bracket



## 92-00 CIVIC

PART NUMBER	CHASSIS	ENGINE / TRANS	RETAIL PRICE
B50050	EJ/EH/EG/EK	B-Series	\$99.99



## 92-00 CIVIC / 94-01 INTEGRA

PART NUMBER	CHASSIS	ENGINE / TRANS	RETAIL PRICE
B50150	EJ/EG/EH/EK/DB/DC	B-Series	\$99.99

2 Bolt Engine Post Mount Bracket



## 92-00 CIVIC / 90-01 INTEGRA

PART NUMBER	CHASSIS	ENGINE / TRANS	RETAIL PRICE
50119	EJ/EH/EG/EK/DA/DB/DC	B-Series	\$149.99

3 Bolt Engine Post Mount Bracket



## 96-00 CIVIC

PART NUMBER	CHASSIS	ENGINE / TRANS	RETAIL PRICE
40020	EJ/EK	B-Series/Hydro2Cable	\$99.99

B-Series Shift Linkage



## 96-00 CIVIC

PART NUMBER	CHASSIS	ENGINE / TRANS	RETAIL PRICE
10022-SB	EJ/EK	B/D-Series	\$75.00

Conversion Transmission Mounting Bracket



## 96-00 CIVIC

PART NUMBER	CHASSIS	ENGINE / TRANS	RETAIL PRICE
50031	EK/EJ/EM/EN	B-Series	\$99.99

Replacement Transmission Mounting Bracket



## 96-00 CIVIC

PART NUMBER	CHASSIS	ENGINE / TRANS	RETAIL PRICE
50080	EK/EJ	H22	\$149.99

Rear Mounting T-Bracket



## 01-06 CIVIC Si / 02-06 RSX

PART NUMBER	CHASSIS	ENGINE / TRANS	RETAIL PRICE
40610-SB	FG/FA/EP3/DC5	K-Series/Auto2Man.	\$114.99

H22 Air Conditioning Bracket



## 02-05 CIVIC Si / 02-06 RSX

PART NUMBER	CHASSIS	ENGINE / TRANS	RETAIL PRICE
90610-SB	EP3/DC5	K-Series/Man.	\$59.99

Conversion Transmission Mounting Bracket



## 92-96 Prelude / 90-93 ACCORD

PART NUMBER	CHASSIS	ENGINE / TRANS	RETAIL PRICE
59630	BB/CB	H-Series	\$99.99

Replacement Transmission Mounting Bracket



## 00-05 MR2 SPYDER

PART NUMBER	CHASSIS	ENGINE / TRANS	RETAIL PRICE
50507	ZZ	Standard Type-S 5/6 Speed Transmission	\$199.99

Rear Mounting T-Bracket

→ 900±.003 ←

Shift Mechanism





# 05-12 ELISE

PART NUMBER	CHASSIS	ENGINE / TRANS	RETAIL PRICE
50910	Misc.	K-Series	\$19.99

Throttle Cable Bracket



# LOTUS

PART NUMBER	CHASSIS	ENGINE / TRANS	RETAIL PRICE
50901	Misc.	K-Series	\$149.99

K-Series Acceleration Pedal



# LOTUS

PART NUMBER	CHASSIS	ENGINE / TRANS	RETAIL PRICE
50903	Misc.	K-Series	\$150.00

K-Series Throttle Cable & Bracket



# LOTUS

PART NUMBER	CHASSIS	ENGINE / TRANS	RETAIL PRICE
50907	Misc.	Standard Type-S 5/6 Speed Transmission	\$199.99

Shift Mechanism



# LOTUS

PART NUMBER	CHASSIS	ENGINE / TRANS	RETAIL PRICE
50908	Misc.	06+ Civic Si Transmission	\$249.99

Shift Mechanism



# LOTUS

PART NUMBER	CHASSIS	ENGINE / TRANS	RETAIL PRICE
50909	Misc.	K-Series/Required DC Sport Header(AHC6515)	\$249.99

Lotus K-Series Mid Pipe

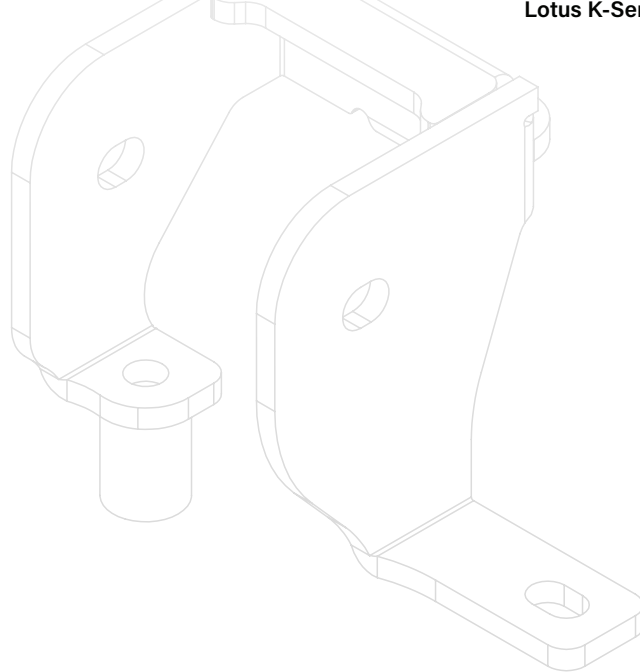

ER	QTY.
	1
	1

FINISH:		DO NOT SCALE DRAWING	
BLACK POWDERCOAT		<i>Innovative Mounts</i>	
NAME   SIGNATURE   DATE			
DRAWN		TITLE:	
CHK'D			
APP'VD			
MFG			
MATERIAL:		DWG NO.	REVISION

## TERMS AND CONDITIONS

The purchaser is responsible for determining the suitability and acceptability of any and all products Purchased from Innovative Mounts

## BUSINESS HOURS

Office hours are 7:00am to 3:30pm Pacific Standard Time, Monday through Friday. You can order product directly from Innovative Mounts, by calling (714) 524-5246 during office hours. You can also order product online via our secure online shopping cart at [www.innovativemounts.com](http://www.innovativemounts.com), via email at [sales@innovativemounts.com](mailto:sales@innovativemounts.com), or via fax at (714) 399-0996.

## TECH SUPPORT

Our technical staff is available from 7:00am to 3:30pm Pacific Standard Time, Monday through Friday by emailing us your information and a description of your troubleshooting issue at [tech@innovativemounts.com](mailto:tech@innovativemounts.com).

## WARRANTY / RETURNS / EXCHANGES

Innovative Mounts' products and applications are warranted for life. If a product is broken during normal use, please email pictures of the mount or application to [sales@innovativemounts.com](mailto:sales@innovativemounts.com).

We will only accept returns or exchanges from customers that have ordered directly from our business. If you did not purchase your part directly from us, we will not accept any return or exchange. If you purchased our product from an authorized distributor, please contact them directly.

Returns or exchanges will be processed if:

Proof of purchase is provided

Item(s) are in the condition it was received in and in the original packaging

The original ship date of product is within 6 months

Returns or exchanges will NOT be processed if:

The item appears to have been used or installed

The item has been modified or altered in any way

The item was not purchased new

The item is not a genuine Innovative Mount product

## SHIPPING

In-stock parts ordered by 1pm Pacific Standard Time will ship the same day. Innovative Mounts ships all orders UPS Ground unless otherwise specified. UPS next day air, 2nd day air and 3-day select are only available on items that are in stock at the time of order. Canada, Hawaii and Alaska shipments may ship US Postal Service if requested in advance. Innovative Mounts does not ship product using other small package carriers. Any shipment that is refused without authorization will be subject to original shipping charges, return shipping charges, and a restocking fee.

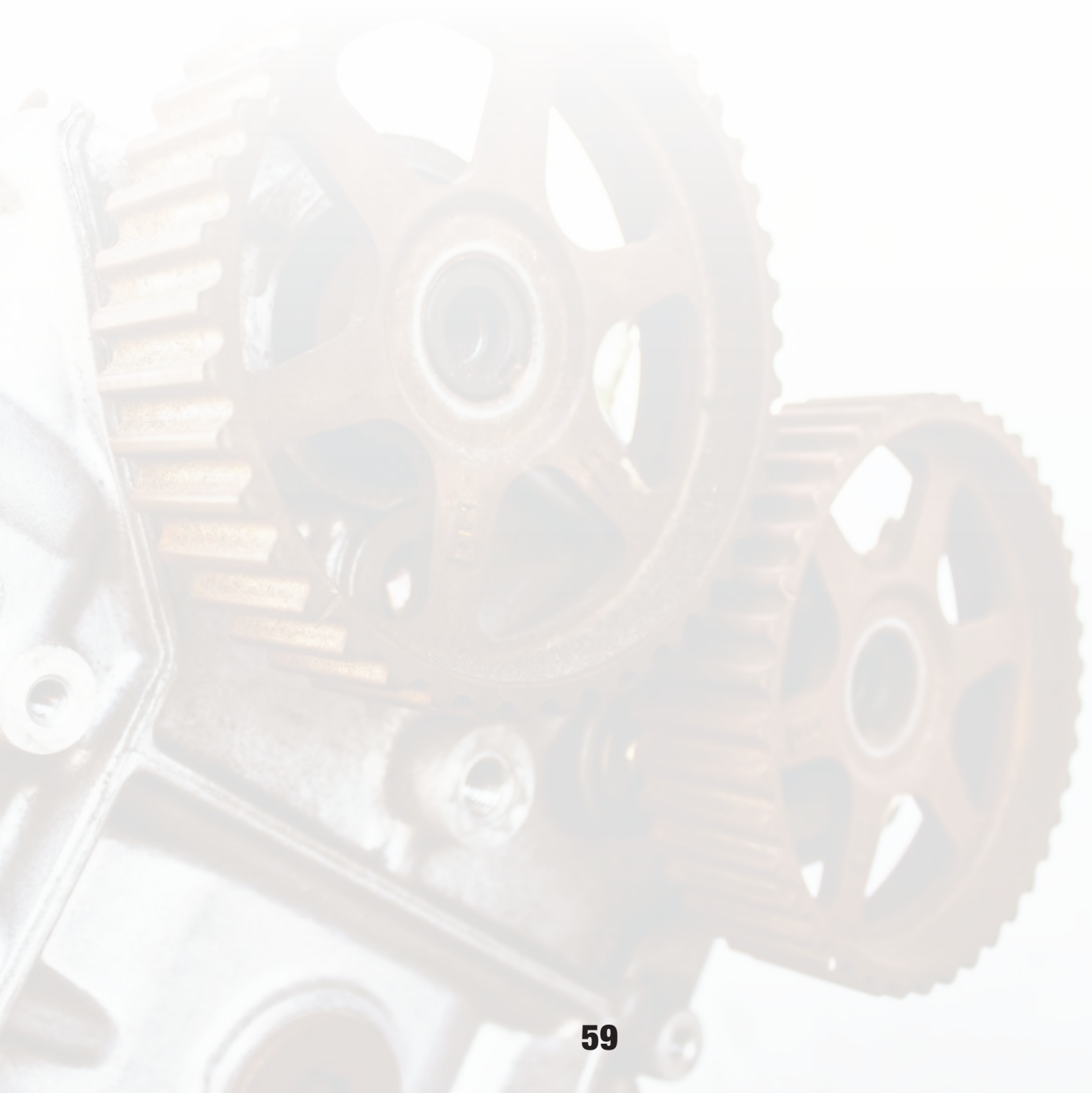



# ***INNOVATIVE MOUNTS***

*1366 N. Hundley St.  
Anaheim, Ca 92806*

*P: (714) 524-5246*

*F: (714) 399-0996*

*[www.innovativemounts.com](http://www.innovativemounts.com)*