

Osaki

OS 4000LS

Instruction Manual

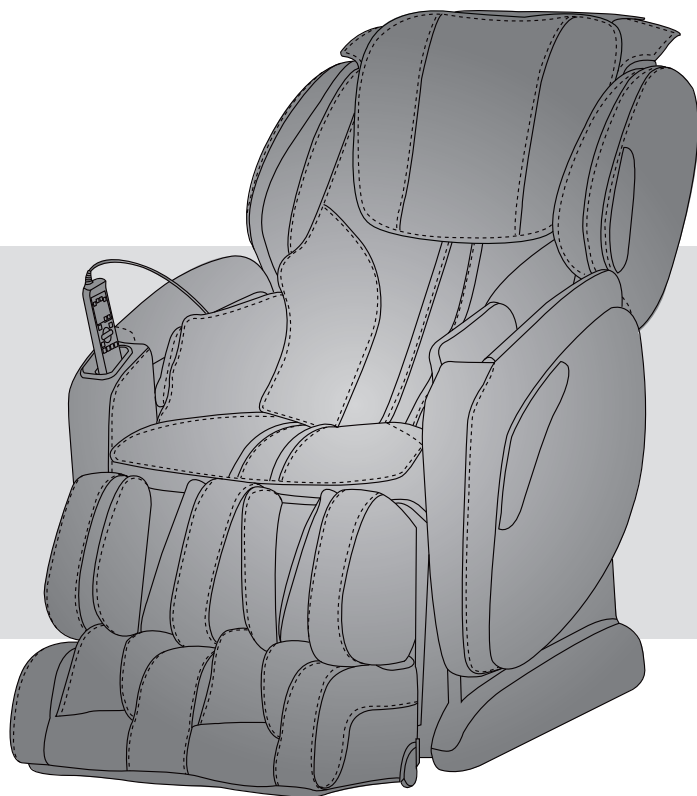

Contents

Before Use

Safety Precautions	1-2
Chair Components	3-4
Chair Installation	5-7
Preparation before Use.....	8-9

How to Use

Controller Diagram.....	10
Programs and Operation.....	11-17

Q&A / Important

Troubleshooting	18
Care and Storage	19
Grounding Instructions.....	20
Chair Specification	21

Thank you for purchasing the OS 4000LS Massage Chair.
Before using your massage chair, please read the contents of this
instruction manual and refer to it when needed.

Safety Precautions

When using the massage chair, basic precautions should always be followed to reduce the risk of electric shock, burns, fire or injury to persons. Please read the following precautions before using the massage chair.

- Make sure the power plug is securely inserted into a proper electrical outlet to reduce the risk of short-circuit and fire.
- It is highly recommended that a surge protector is used to prevent from damage.
- DO NOT use the massage chair in areas where the humidity is high such as a sauna steam room, Pools, bathrooms, AC or heating vents, etc.
- DO NOT use the massage chair outdoors and avoid areas with direct sunlight.
- If the chair is not being used, turn the power switch to the OFF position and unplug the massage chair from the electrical outlet to prevent any damages to the chair when there are power outages/surges that may cause serious damage.
- Never plug/unplug the power cord plug socket with wet hands.
- Close and continuous supervision is necessary when the massage chair is used by, on or near children or disabled persons.
- No more than one person should use the massage chair at the same time.
- The massage chair is intended for use as described in the Instruction Manual. Do not use any attachments other than those recommended by the manufacturer.
- DO NOT attempt to stand or sit on the backrest, armrest or footrest in order to prevent accident, injury or damage to the chair.
- Avoid falling asleep while using the massage chair.
- Always keep the massage chair clean, and never insert any objects into or around the gaps of the massage chair.
- DO NOT move the massage chair by pulling on the power supply cord.
- Make sure there are no children, pets or other obstacles behind or underneath the massage chair.
- If you find any rips or tears in the fabric of the massage chair contact the service department and stop using the chair immediately.
- This massage chair is designed for household use and should not be used in non-residential settings.

Safety Precautions

- Please consult your doctor if you are in doubt as to whether or not you should use this massage chair.
- Please consult a doctor before using the massage chair if you are pregnant, undergoing any medical treatment, using a medical electronic device such as a pacemaker, or are experiencing any of the following: Malignant tumor, heart disease, back pain, abnormal or curved back bone, osteoporosis or acute illness.
- If you experience pain while using the massage chair, stop using the chair immediately and consult your doctor.
- Never use a massage function on swollen or inflamed parts of the body.
- DO NOT use the massage chair for more than 30 minutes at a time.
- DO NOT use the massage chair where aerosol(spray) products are being used or where oxygen is being administered.
- This massage chair is a non-professional product designed to provide a comfortable massage and should not be substituted for appropriate medical treatment.
- Never operate the appliance with the air hoses that inflate while they are blocked. Keep the air openings free of lint, hair, and any other obstructions.
- Check the skin in contact with the heated area of the appliance frequently to reduce the risk of injury. If the heating pad malfunctions and extreme heat is produced it may cause serious burns.
- Burns may result from improper use. If this is the case immediately shut off the chair and unplug from the outlet.
- Remove all sharp objects from the body and pockets such as keys and Pens.
- Keep children away from extended foot support (or other similar parts.)
- DO NOT WET-DO NOT USE PINS.
- NEVER REMOVE COVER.

Caution

The user's weight is usually limited to 220 lbs.

When using the massage chair, the mechanism will stop for safety while there is too much pressure on it. When that happens, please switch off the power and restart after 10 seconds.

Chair Components

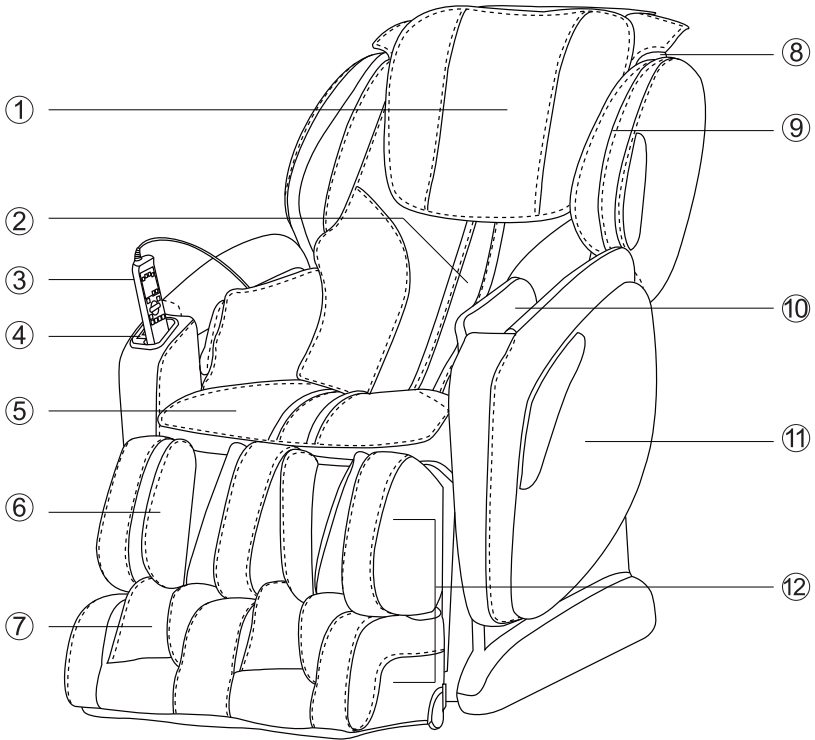

- | | | |
|--------------|----------------|--------------|
| ① Pillow Pad | ② Backrest Pad | ③ Controller |
| ④ USB | ⑤ Seat Pad | ⑥ Calvesrest |
| ⑦ Footrest | ⑧ Backrest | ⑨ Shoulder |
| ⑩ Armrest | ⑪ Side Panel | ⑫ Legrest |

Chair Components

Massage Position

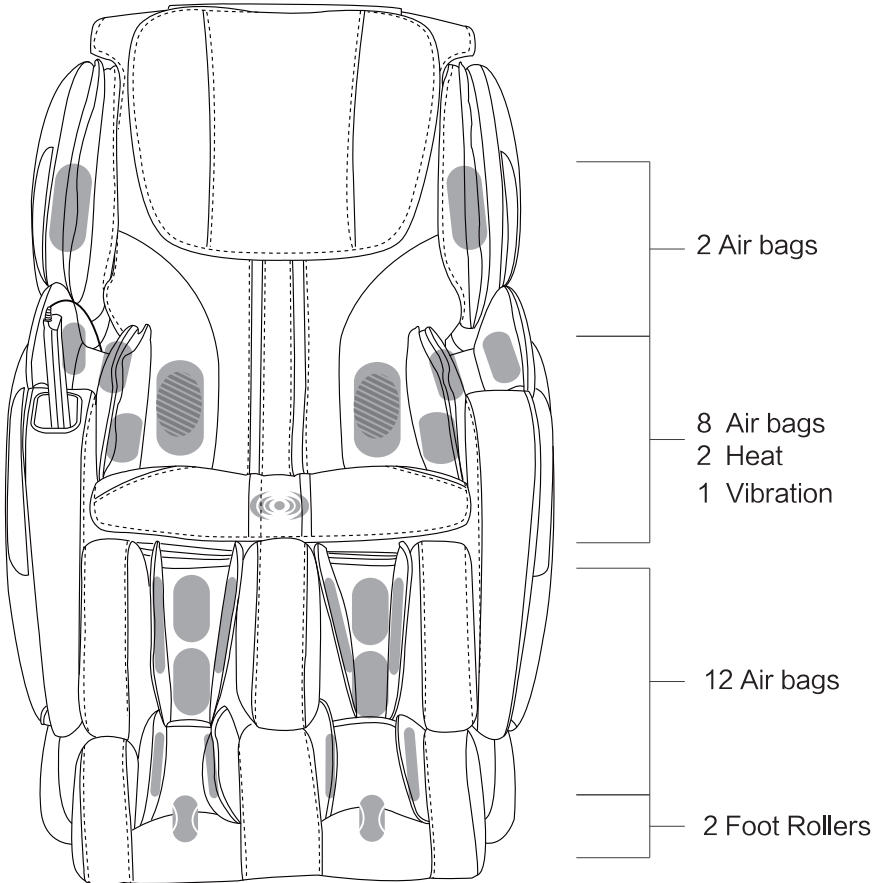

Chair Installation

1. Take out the main unit and accessories from two boxes.

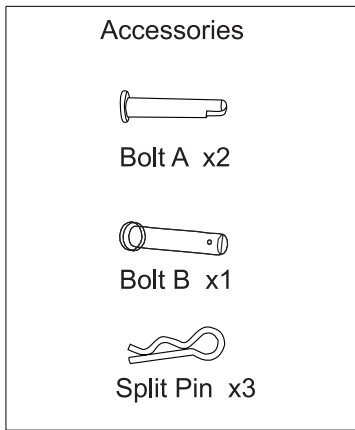
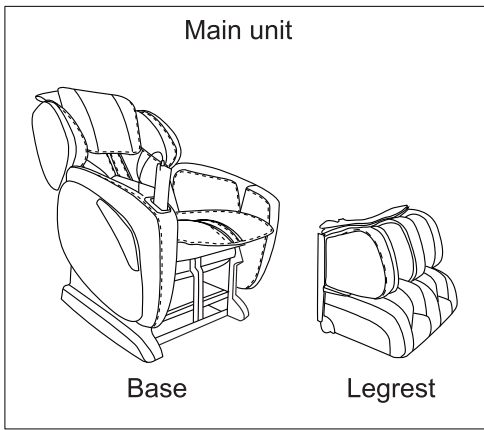

2. Connect the wires and air pipes from the footrest and seat part respectively.

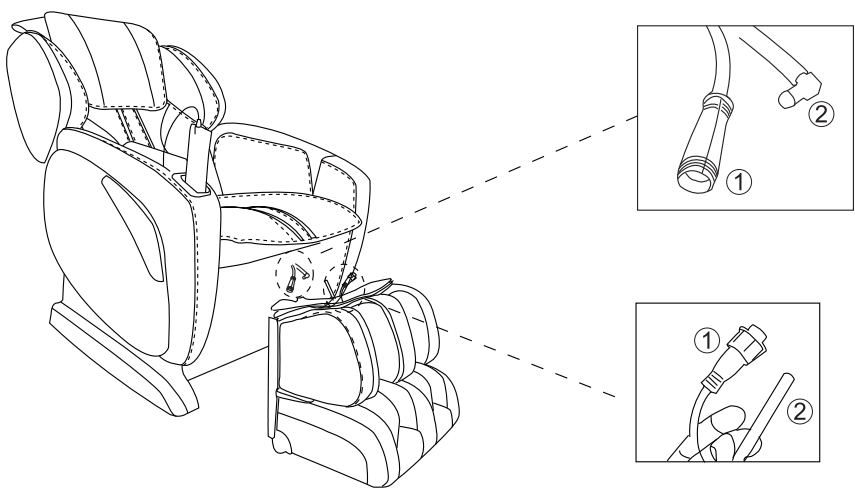

Chair Installation

3. Align the connecting holes from the footrest and seat part.
Insert bolt A and secure with split pin as demonstrated.

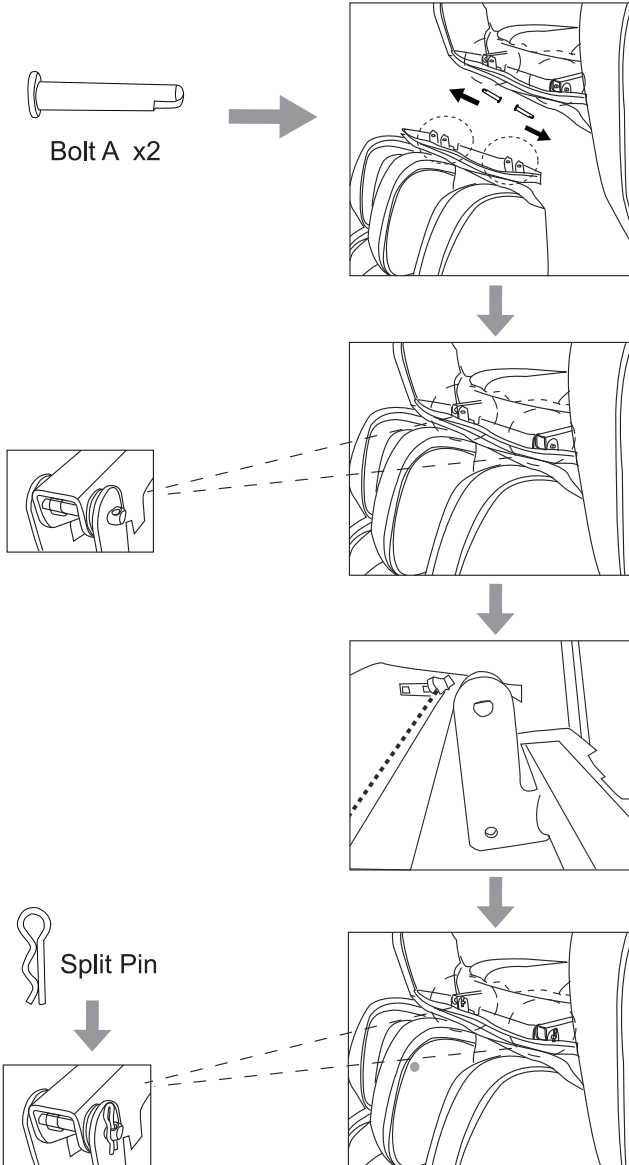

Chair Installation

4. Lift the legrest to a horizontal position and align the connecting hole. Insert bolt B and secure with split pin as demonstrated.

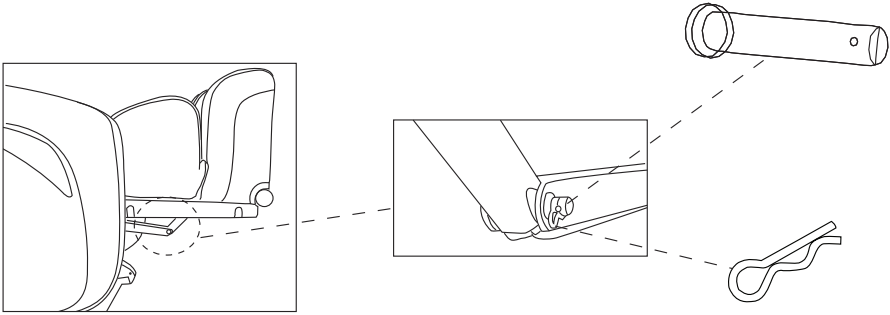

5. Attach the seat cover and footrest cover with the zipper.

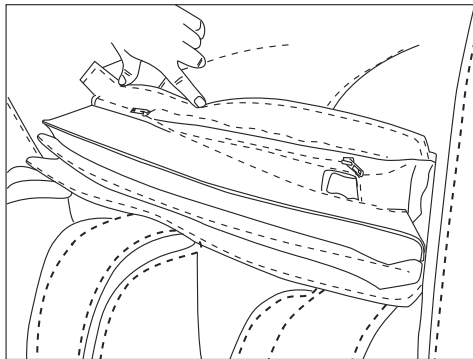

Preparation before Use

1. Placing the chair

Ensure sufficient spaces around massage chair, please leave 4.7" of spaces behind the backrest and 7.1" of spaces at the front of massage chair.

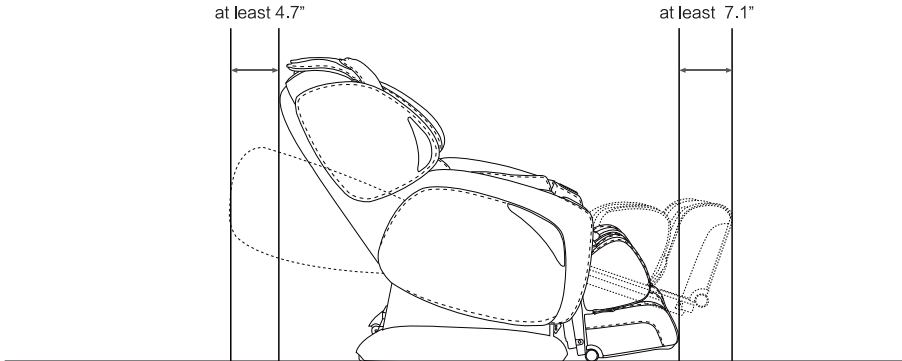

2. Moving the chair

Lift up the footrest then recline the chair to approximate 45° to easily move the chair around the house with a slight pull or push

 Caution

1. Before moving the chair, please adjust the legrest back into the original position.
2. Do not move the massage chair when there is someone seated on it.
3. Placing a mat underneath the massage chair is advisable, as the moving process might leave scratches on the floor surface.

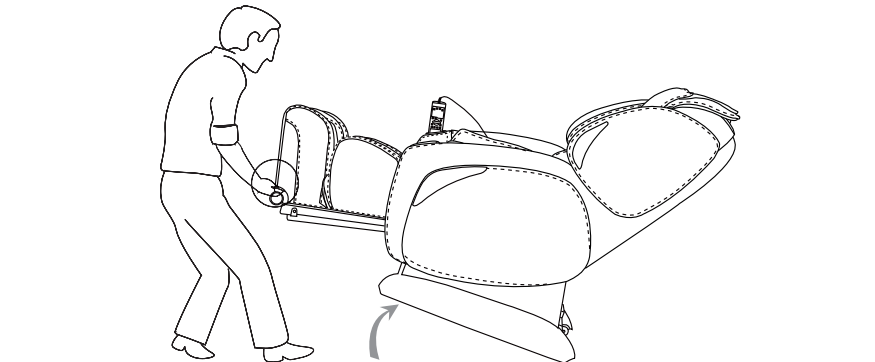

Preparation before Use

3. Placing the cushion pad

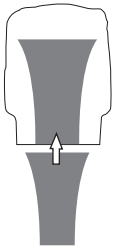

Note: The back pad is installed with an additional pad to soften the massage. If you desire a stronger massage simply remove the extra pad and proceed to zipping the pad to the top of the backrest.

4. Adjusting the shoulder

Push the shoulder to select between 3 levels of width.

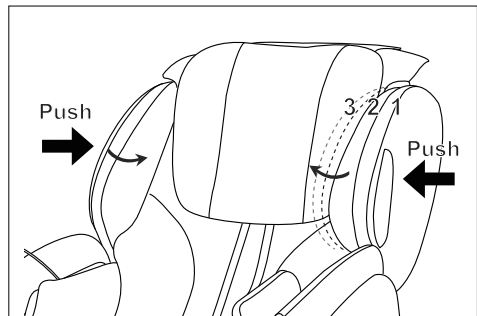

5. Switching the power on

- ① Connect the wire plug .
- ② Connect to the power supply.
- ③ Turn the switch to "I" position.

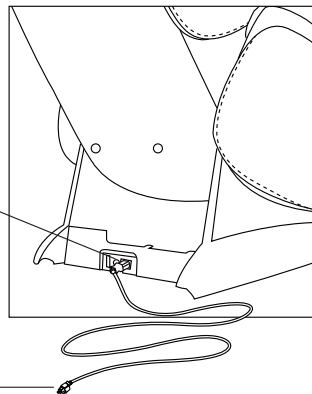
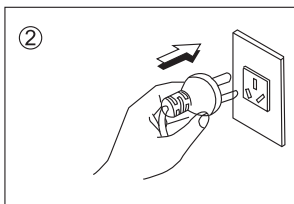
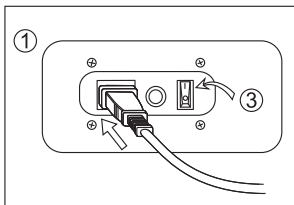

Programs and Operation

Controller (More details, please refer to the page number after the programs.)

- 1. Power (P14)
- 2. Timer (P14)
- 3. Pause (P14)
- 4. Deep Tissue (P14)
- 5. Stretch (P14)
- 6. Energy (P14)
- 7. Relax (P15)
- 8. Full Air (P15)
- 9. Manual Air (P15)
- 10-11. Width (P15)
- 12-13. Position (P15)
- 14. Vibration (P15)
- 15. Heat (P16)
- 16. Spot/Partial (P16)
- 17. Intensity (P16)
- 18. Speed (P16)
- 19. Zero Gravity (P16)
- 20. Roller (P16)
- 21. Footrest Lift (P16)
- 22. Footrest Drop (P16)
- 23. Recline (P17)
- 24. Incline (P17)
- 25. Kneading (P17)
- 26. Tapping (P17)
- 27. Shiatsu (P17)
- 28. Rolling (P17)

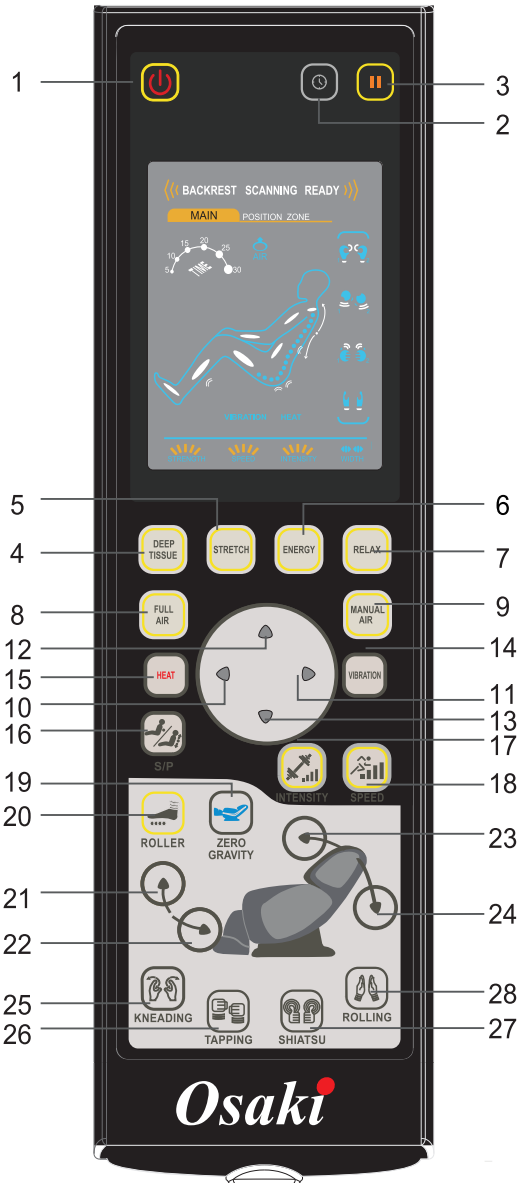

Programs and Operation

Automatic massage programs

The OS-4500LS features 5 automatic massage program to help you enjoy the benefits of a relaxing and invigorating massage.



1 Press the [⏻] button to switch on. The chair will recline into ready position.
(Ready position: Leg rest will raise slightly and backrest will recline slightly.)

2 Select any of the 5 automatic massage programs DEEP TISSUE, STRETCH, ENERGY, RELAX and FULL AIR (refer to page 14-15 for details) and press the button.

3 The massage program begins when initialisation is completed. During the process, you must remain seated with your head resting on the headrest. Also, you can adjust your desired shoulder position further by pressing the [▲] or [▼] button within 6 seconds after initialisation function has ended.

4 Press the [HEAT] button to switch on or off the heat. Press the [VIBRATION] button to switch on or off the seat vibration.
Heat and Vibration function is available for selection during the automatic massage program.

5 Press the [⌚] button to adjust the duration for 20, 25, 30, 05, 10, or 15 minutes.

Note

Keep each massage session to no longer than 15 minutes.

Keep massage session to a maximum of 30 minutes per day.

In an emergency or any malfunction, press the [⏸] button to pause the massage immediately. Press the [⏻] button to bring the rollers to the storage position again and turn off the main power switch.

Programs and Operation

Manual massage programs











The image shows the control panel of an Osaki chair. The panel features a large LCD screen at the top displaying a human figure with massage points and settings. Below the screen is a control area with several buttons: a power button, a backrest scanning button, a manual air button, a heat button, a vibration button, and a directional pad. At the bottom of the panel are buttons for different massage programs: KNEADING, TAPPING, SHIATSU, ROLLING, and ZERO GRAVITY. The Osaki logo is at the bottom of the panel.





- 1 Press the [⏻] button to switch on. The chair will recline into ready position.
(Ready position: Leg rest will raise slightly and backrest will recline slightly.)
- 2 Press the [🪑] button to recline to zero gravity position or [🌀] [🌀] button to your desired position.
- 3 Select any of the 4 manual massage programs KNEADING, TAPPING, SHIATSU or ROLLING (refer to page 17 for details) and press the button.
- 4 Press the [📍] button once to localize the massage to a particular point. Press again to shift massage to a particular area of body.
- 5 Press the [Manual Air] to combine the air massage.
- 6 Press the [HEAT] button to switch on or off the heat. Press the [VIBRATION] button to switch on or off the seat vibration. Heat and Vibration function is available for selection during the manual massage program.
- 7 Press the [📶] button to change the massage speed. Press the [📶] button to change the air massage intensity. Press the [◀▶] button to adjust width.

Programs and Operation

Manual massage mode

Action	Button	Speed	Intensity	Width	S/P	Timer
	Button 					
Kneading		<input type="radio"/>	<input type="radio"/>	<input type="radio"/>	<input type="radio"/>	<input type="radio"/>
Tapping		<input type="radio"/>	<input type="radio"/>	<input type="radio"/>	<input type="radio"/>	<input type="radio"/>
Shiatsu		<input type="radio"/>	<input type="radio"/>	<input type="radio"/>	<input type="radio"/>	<input type="radio"/>
Rolling		<input type="radio"/>	<input type="radio"/>	<input type="radio"/>	<input type="radio"/>	<input type="radio"/>
Manual Air	MANUAL AIR	<input type="radio"/>	<input type="radio"/>	<input type="radio"/>	<input type="radio"/>	<input type="radio"/>

Combination of manual massage

Action	Button	Heat	Vibration	Roller	Manual Air
Kneading		<input type="radio"/>	<input type="radio"/>	<input type="radio"/>	<input type="radio"/>
Tapping		<input type="radio"/>	<input type="radio"/>	<input type="radio"/>	<input type="radio"/>
Shiatsu		<input type="radio"/>	<input type="radio"/>	<input type="radio"/>	<input type="radio"/>
Rolling		<input type="radio"/>	<input type="radio"/>	<input type="radio"/>	<input type="radio"/>

Stopping a massage session

Press the [⏻] button to stop the massage functions. The rollers will move back to the storage position and all airbags will deflate, ending the massage.

Pausing a massage session

To pause a massage, press the [⏸] button on the controller. This will temporarily freeze all operations. Press the [⏸] button again to resume your massage.

Programs and Operation

Programs Description

1.Power

- Starts and stops all functions of the massage chair.
- Press once. Remote control will light up and chair will be in idle mode.
- You can press any massage function buttons to begin your massage session, at a default time of 15 minutes.
- Press again, all functions will stop and massage rollers will return to original position.

2.Timer

- Controls the duration of the massage session.
- The default time for all massage functions is 15 minutes.
- Press each time to change the duration for 20, 25, 30, 05,10 or 15 minutes.

3.Pause

- All massage functions will stop temporarily.
- Press once and the Pause icon will light up.
- Massage functions and timer will be stopped temporarily.
- Press again to resume the massage session.

Auto Programs

- This function is a full body massage with 5 different massage styles.
- Position of the chair can be manually adjusted.
- Massage session is 15 minutes by default.

4.Deep Tissue

- Engages the full body deep tissue massage. This program focuses on neck, shoulder, waist and hip.

5.Stretch

- Engages the full body stretching auto program. This program stretches the back muscles, hands, hamstrings and the full body.

6.Energy

- Engages the full body wake up auto program.
- This program will deliver a light, stimulating tapping massage throughout the whole body.

Programs and Operation

7. Relax

- Engages the full body relax auto program.
- This program will start with slow kneading and heavy tapping massage, progressing to in-depth massage targeting the neck and lower back.

8. Full Air

- Engages the the full body air pressure auto program.
- This program applies full body air pressure massage to shoulder, arm, palm, lower back, buttocks, thighs, calves and feet.
- Full Air intensity can be adjusted by pressing “Intensity” button respectively after activating full air function.

9. Manual Air

- Press this button to activate and select air massage zone between armrest, shoulder & waist, calves and feet.
- Air intensity can be adjusted by pressing "Intensity" button respectively after activating manual air function.
- Full Air intensity can be adjusted by pressing “Intensity” button respectively after activating full air function.

10/11. ◀/▶ Width

- Controls the width of the rollers.
- Select a massage function and press to adjust between Narrow, Normal and Wide.
- It can be used to activate the Tapping, Shiatsu and Rolling massage.

12/13. ▲/▼ Position

- Adjust back massage position.
- Press ▲ or ▼ to choose position of massage rollers when a “beep” sound alerts in 10 seconds.
- Release the button once the desired position is achieved.

Note: This can also be used during sector massages.

14. Vibration

- Press this button once to activate the seat vibration function. Press the button again to stop the seat vibration function.
- The vibration mode can be switched on or off while any of the programs are running.

Programs and Operation

15. Heat

- Heat function is set to OFF by default.
- Press this button once to activate the waist heating function. Press the button again to stop the waist heating function.
- It is applicable during any Automatic Program, Localised Area Program or Manual Program.

16. Spot/Partial (S/P)

- Press once to localize the massage to a particular point.
- Press again to shift massage to a particular area of body.
- This will keep the original massage node working on a range of 8cm.
- To resume full back massage, press button again.

17. Intensity

- Press this button to adjust the air pressure intensity level.
- After activating the auto or manual air massage programs, press to select between 5 levels of intensity.

18. Speed

- Press this button to adjust speed for Tapping, Shiatsu and strength for Kneading.
- After activating the Tapping, Shiatsu or Kneading function, every time the button is pressed, the speed (or strength) can be adjusted in the cycle.

19. Zero Gravity

- Adjust the angle of the massage chair to zero gravity position.
- Press to achieve position required.
- Press again to resume to original position.

20. Roller

- Press once, to activate the roller massage.
- Press again, to stop the roller massage.

21/22. Footrest lift / drop

- Allows you to lift or drop the footrest.
- Press once and the footrest will start to lift/drop.
- Press again to stop the footrest at your preferred angle.

Programs and Operation

23/24. Recline / Incline

- Control the recline / incline angle of the chair.
- Press once and the backrest will move to a horizontal reclining position or an upright sitting position. Press again to stop at your preferred angle.

25. Kneading

- Press this button once to activate the kneading function for a full back massage. Press again to stop the kneading function.
- Kneading function strength can be adjusted by pressing “Speed” button after activating kneading function.
- Kneading function can be combined with tapping or shiatsu.

26. Tapping

- Press this button once to activate the tapping function for a continuous full back massage. Press again to stop the tapping function.
- Tapping width and speed can be adjusted by pressing “Width” and “Speed” button respectively after activating tapping function.
- Tapping function can be combined with kneading function.

27. Shiatsu

- Press this button once to activate the shiatsu function for a continuous full back massage. Press again to stop the shiatsu function.
- Shiatsu width and speed can be adjusted by pressing “Width” and “Speed” button respectively after activating shiatsu function.
- Shiatsu function can be combined with kneading function.

28. Rolling

- Press this button once to activate the rolling function for a full back massage. Press again to stop the rolling function.
- Rolling width can be adjusted by pressing “Width” button after activating rolling function.

How to End

- Press the Power button to stop the massage operation.
- Massage rollers will reset automatically.
- The Power button will light up until the massage rollers resume their original position.
- After the Power button light turns off, switch the power button under the chair to “O” position and disconnect the power cord plug.

Troubleshooting

This page summarizes the most common problems you could encounter with the product. If you are unable to solve the problem with the information below, contact service center immediately.

If the problem encountered is not listed, please try the following suggestions:

1. Turn off the product and unplug it.
2. Wait for 60 minutes.
3. Plug the product back to the recommended outlet and restart.
4. If the problem persists, contact the authorized service center.

Problem	Possible Cause	Suggestion
The product does not work	The product is not plugged in properly.	Ensure the voltage on the product corresponds to the local mains voltage and then plug in again. Make sure the outlet is properly working.
The product stopped working	The product has just finished its auto timer session and has automatically switched to standby mode.	If you want another session, press the Power button again.
The product stopped working	You may have used the product continuously for 45 minutes where the over heat protection has been activated.	Unplug the product and let it cool down for 60 minutes before you use it again.
The product does not work	An excessive load has been applied on the product.	Reduce the excessive load and start again.
The product is abnormally warm	The product is likely to be overused.	Unplug the product and let it cool down before using it again.
Noise can be heard from the	Noise is made by the mechanical parts of the	This is normal and does not mean that the product is faulty.

Care and Storage

1. Cleaning

Never use scouring pads, abrasive cleaning agents or aggressive liquids such as petrol or acetone to clean the appliance. When wiping down the chair use non toxic cleaners and be sure the cloth is moist and NOT wet.

Do not immerse to appliance in water.

- ① Remove the main plug from the wall socket.
- ② Clean the control panel and cords with a dry cloth.
- ③ Do not use a moist cloth or a cleaning agent.

2. Storing

- ① Disconnect the product from the power source after use.
- ② Keep the massage chair away from direct sunlight, high temperature or high humidity.
- ③ Do not put heavy objects on the product.

If the outer cover is torn or the mechanism is damaged, stop using the appliance and get advice from the service center.

If you have any questions with your massage chair, please do not hesitate to contact the service center.

Grounding Instructions

This product must be grounded. If it should malfunction or break down, grounding provides a path of least resistance for the electric current to reduce the risk of electric shock. This product is equipped with a cord with an equipment-grounding conductor and a grounding plug. The plug must be plugged into an appropriate outlet that is properly installed and grounded in accordance with all local codes and ordinances.

Danger-Improper connection of the equipment-grounding conductor can result in a risk of electric shock. Check with a qualified electrician or service technician if the product will not fit the outlet, have a proper outlet installed by a qualified electrician.

This product is for use on a nominal 120V circuit and has grounding plug that looks like that plug illustrated below. Make sure that the product is connected to an outlet having the same configuration as the plug. No adapter should be used with this product.

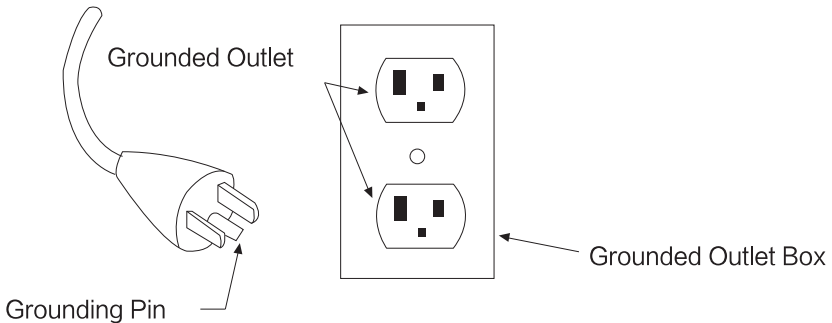

Chair Specifications

Description	Specifications
Model No.	OS 4000LS
Rated Voltage	110V~120V
Rated Frequency	50/60Hz
Rated Power Consumption	180W
Timer	5/10/15/20/25/30 minutes
Max Time Rate	30 minutes
Dimensions(L x W x H)	Upright:63.4"x30.7"x47.2"
	Reclined:78.0"x30.7"x33.9"
	Carton 1 : 62.0"x32.5"x33.9"
	Carton 2 : 22.8"x19.7"x20.9"
Weight	Gross Weight: 271.7 lbs
	Net Weight: 226.6 lbs
Length of Wire	Controller wire: 59.0"
	Power supply wire: 70.9"
Usage Condition	Environment temperature: 10°-40°
	Contrasting humidity: 30-85RH
Storage Condition	Storage temperature: 20°-60° safety
	IStorage humidity: 30-85RH
Safety Feature	Equipped with overheated and power surge safety protection.

