

BM-E1993 MASSAGE CHAIR Ease21
Operation Instructions

SAVE THESE INSTRUCTIONS

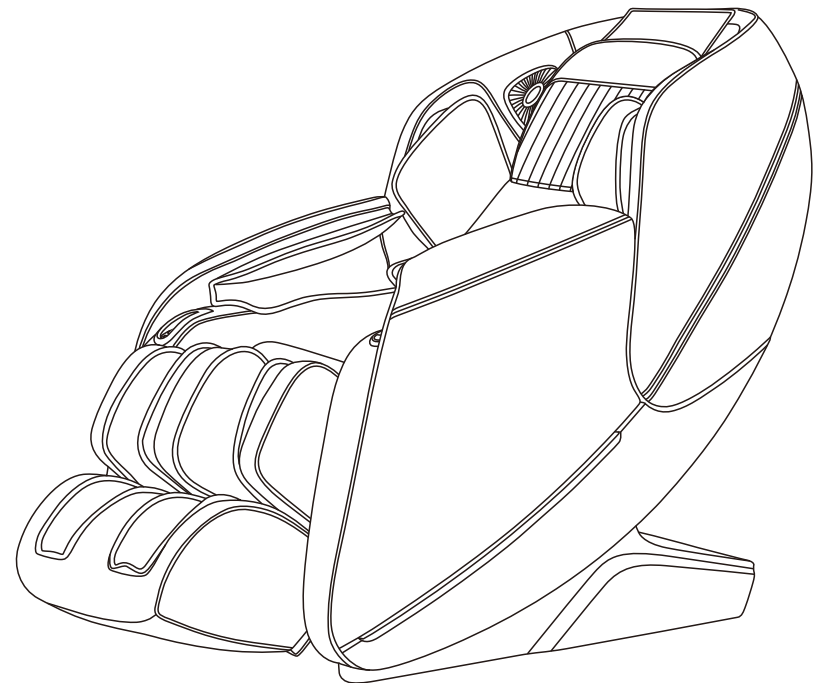

Thanks for purchasing this product. Please read this manual instruction carefully in order to know how to use this product correctly before operation. Please pay more attention to some important safety warning and keep this manual book properly for future use.

Note: Our Company reserves the right to revise the design and description of this product without any further notice. Please refer to the actual color of this product.

CONTENTS

Safety and maintenance	02
Safety warning	04
Name and function of components	06
Function	07
Method of usage	08
Product specification	19

Safety and maintenance

1. Important Safety Warning.

- Please do not allow children to touch moveable part of this product.
- Please use well-grounding power supply suited to this product.
- Please pull out the plug after use or before cleaning to avoid injury or damage to the product.
- Please operate this product according to this manual instruction.
- Please do not use accessories which are not recommended.
- Please do not use this product outdoors.
- Please read this manual instruction carefully before operation.
- Any other usage that is not listed in this manual instruction is forbidden.
- 20 minutes of usage each time is recommended.
- Please do not use it if the leather is broken or damaged.
- Please do not use it if the cover or leather is damaged.
- Please do not use it if the radiator hole is covered or blocked.
- Please do not drop anything into this product.
- Please do not fall asleep while using this product.
- Please do not use it if drunk or feel unwell.
- Please do not use it within one hour after having meal.
- Please do not make the massage function too strong for avoiding Injury.
- Please do not carry fragile, explosive and combustible materials in your pocket such as mobile phones, lighters and so on, when using massage chair.

2. Environment for usage.

- Please do not use it under high temperature and moist environment such as bathroom.
- Please do not use it immediately while the environmental temperature changes sharply.
- Please do not use it under heavy-dusty or caustic environment.
- Please do not use it where there is not enough space or not good ventilation.
- Normal room temperature 0 °C to 35 °C.
- Please do not use this product in an excessively humid room (such as a bathroom) at a relative humidity of 20% to 80%.
- Please do not use this product outdoors.
- Avoid direct sunlight.
- Keep this product away from heat source (such as the fireside, the air outlet of the air conditioner).
- Please do not use this product in lightning weather.
- Please do not use this product in dusty places.

3. People who are not suitable to use this product.

- People who are suffering from osteoporosis are not suitable to use this product.
- People who are suffering from heart disease or carrying electronic medical equipment such as heart pacemaker are not suitable to use this product.
- People who are suffering from fever are not suitable to use this product.
- Pregnant women or women that are in menses period are not suitable to use this product.
- People who got injured or skin disease are not suitable to use this product.
- Children under 14-year old or people mentally unbalanced without being Supervised are not allowed to use this machine.
- People who are told by doctor to have rest or people who feel unwell are not suitable to use this product.
- People whose bodies are wet are forbidden to use this product.
- The appliance has a heated surface. persons insensitive to Heat must be careful when using the appliance.

Safety and maintenance

4. Safety.

- Check the voltage if it is suitable to the specification of this product.
- Please do not use wet hand to pull the plug.
- Please do not make water go inside this product to avoid electric shock or cause damage to this product.
- Please do not damage the wires or change the circuit of this product.
- Please do not use wet cloth to clean the electric parts such as switch and plug.
- Be away from this product under power cut state to avoid injury if the power comeback suddenly.
- Stop using this product while it works abnormal, and please consult local agent immediately.
- Stop using this product if you feel unwell, and please consult health care doctor.
- This appliance is not intended for use by persons (including children) with reduced physical, sensory or mental capabilities, or lack of experience and knowledge, unless they have been given supervision or instruction concerning use of the appliance by a person responsible for their safety.
- Children should be supervised to ensure that they do not play with the appliance.
- If the supply cord is damaged, it must be replaced by the manufacturer, its Service agent or similarly qualified persons in order to avoid a hazard.

5. Maintenance.

- This product should be maintained by certain appointed agents, users are prohibited to disassemble or maintain by themselves.
- Please do not forget to cut the power after usage.
- Please do not use this product if the socket looses.
- If this product will be left unused for long, please curl up the wires and reserve this product in dry and dustless environment.
- Please do not reserve this product under high temperature or near fire and avoid longtime direct sunshine.
- If the detachable cord / supply cord is damaged, it must be replaced by the manufacturer, its service agent or similarly qualified persons in order to avoid a Hazard.
- Please clean this product by dry cloth. do not use thinner, benzene or alcohol.
- The mechanical components of this product are specially designed and made, it is not necessary to be specially maintained.
- Please do not use edged res to thrust this product.
- Please do not roll or pull this product above uneven ground, it should be lifted before moving.
- Please use it intermittently; please do not make this product work continuously for long.

6. Solution of ordinary malfunctions.

- It is nature movement voice if the motor sounds while in usage.
- If the controller can't work normally, please check the plug and socket if they are connected strongly and make sure the switch is turned on.
- If the rated working time is over, the product will automatically activate the power-off button; If this product works continuously for long, the temperature protector will make the product automatically power-off, it should be used again after half an hour's rest.

7. Storing conditions

- Storage room temperature -5 °C ~ 35 °C.
- Relative humidity 20% to 80%, no corrosive gas and well ventilated room.

Safety warning

⚠ Warning

When the footrest lifting, people should not apply pressure on the footrest to avoid the massage chair falling forward to damage the product or cause personal injuries.

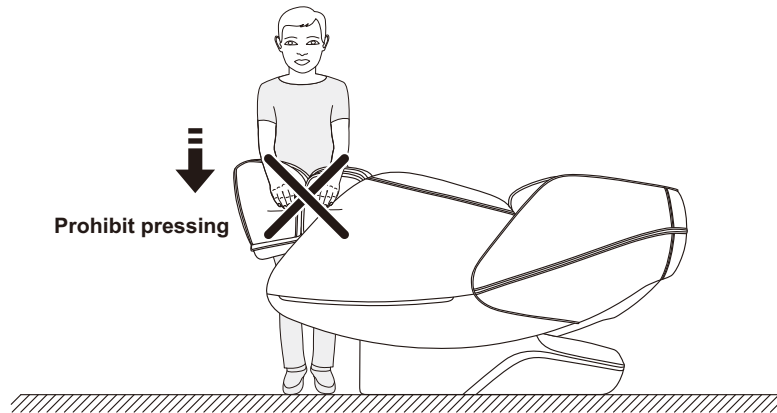

⚠ Warning

Before sitting on the massage chair, make sure that the massage hand stays in the seat cushion position to avoid discomfort to the buttocks during the body pressing down and damage to the massage hand.

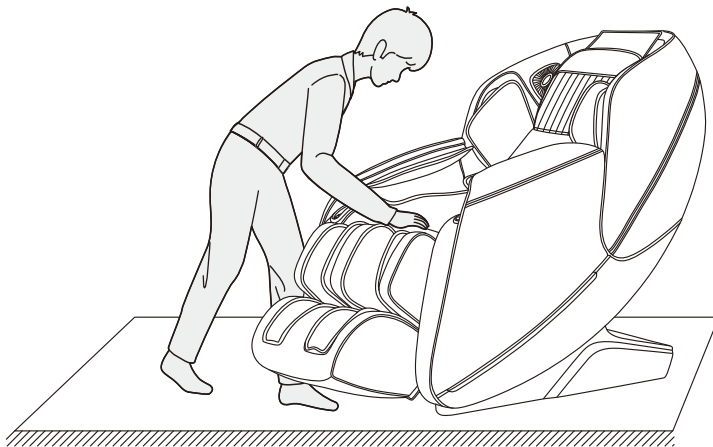

Safety warning

⚠ Warning

Do not strive to pull out the control cable or power cord during standby or power-on state to avoid product damaged or electrocution accidents. Advise you unplug the controller cable and power cord and put away after you use the chair.

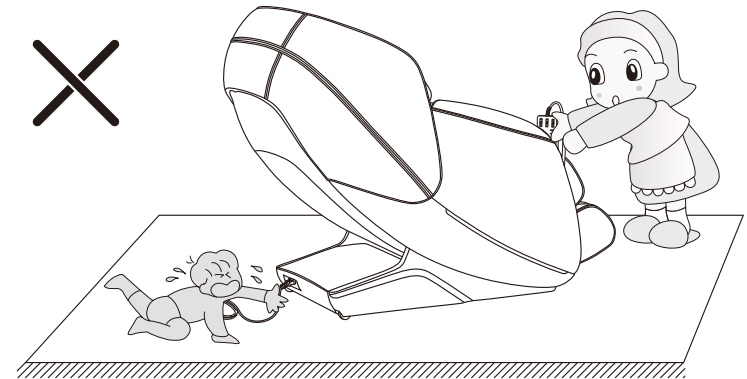

⚠ Warning

When start the zero gravity lying function, be sure to check whether there are children and pets under the bottom of the footrest and backrest, may cause the product damaged or personal injuries.

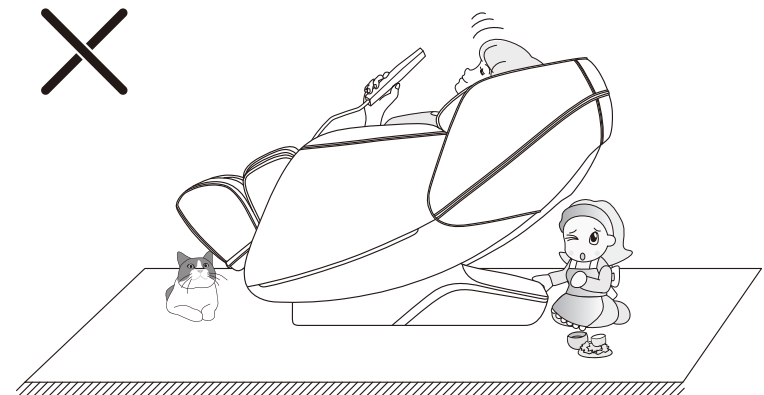

Name and function of components

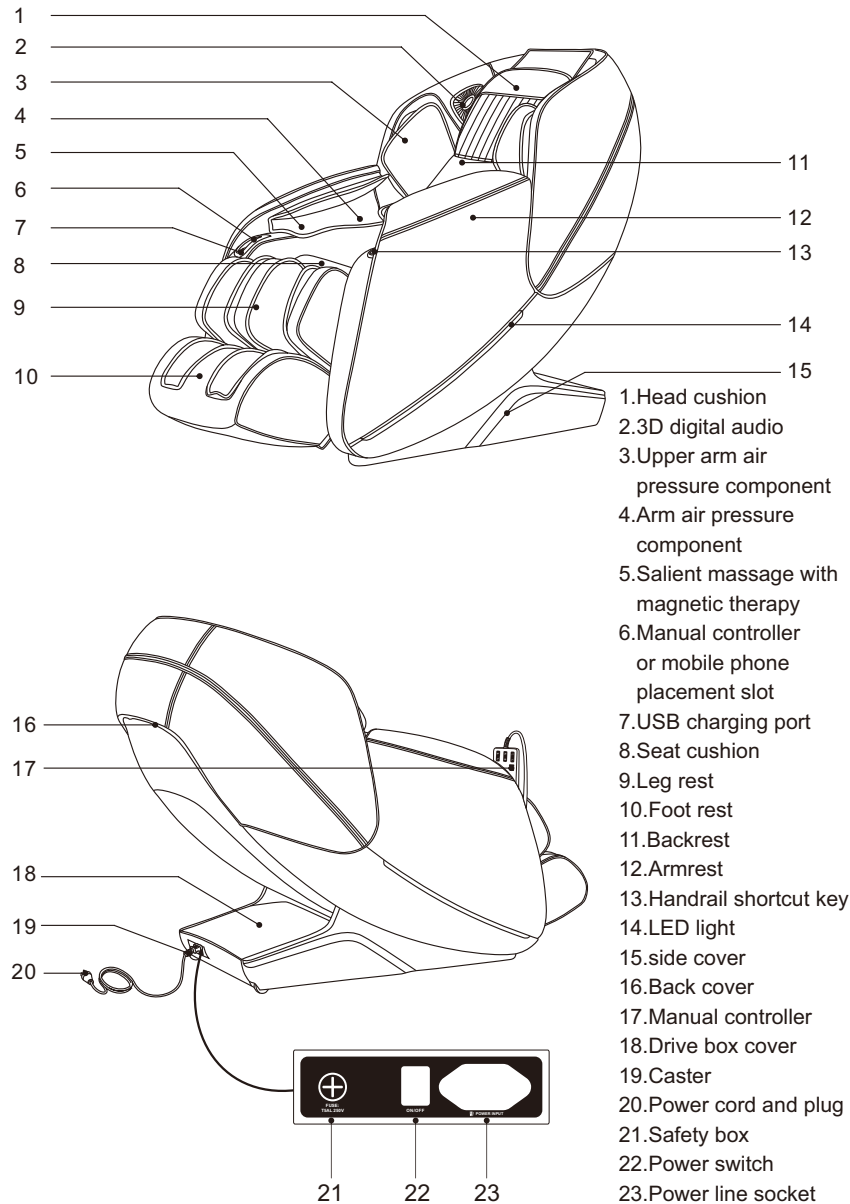

Function

- This product has designed a set of massage hand that can walk up and down, four-wheel drive and mute design.
- There are five simulative massage techniques: Shiatsu, kneading, tapping, kneading & tapping, knocking.
- Equipped with shoulder position detection automatically.
- Automatic massage functions: automatic massage includes 12 kinds of automatic massage functions, including comfortable massage, relaxing massage, traction massage, shoulder and neck massage, back and waist massage, whole body massage, Protection of vertebral massage, fatigue recovery, stretching muscles and activating collaterals, beautiful buttock shaping, soothing sleep and full air pressure.
- Equipped with upper body manual massage function (the whole body, fixed point and local three massage parts are selected, and the speed of each massage manipulation can be adjusted with five speed. In fixed point and local state, the massage hand can adjust the position up and down; When in tapping, shiatsu and knocking massage program, the width of the massage ball can be adjusted in 3 levels
- It has air pressure massage function: upper arm air pressure massage function (built-in 4 airbags), arm air pressure massage function (built-in 8 airbags), calf air pressure massage function (built-in 16 airbags), and 3adjustable air pressure intensity adjustment.
- Footrest extendable, push your feet forward to get your wanted length, and spring back as your feet retract.
- Footrest lifting independently, backrest and footrest lifting together function, zero gravity function.
- With back heat treatment function: carbon fiber as far infrared heat source.
- The backrest adopts slide rail technology to keep the zero space against the deviation wall all the time, save space.
- Backrest frame guide adopts curve guide technology, which completely conforms to the curve of human back, and can enjoy massage from head to thigh.
- Music playback system, 3D digital audio built into left and right upper arms. Use the Bluetooth function of the smart device to play music wirelessly.
- With foot roller massage function, and a set of rollers scraping massage on foot.
- The front end of the right armrest is provided with a manual control slot or a mobile phone slot, and has a USB charging function.
- In the left and right palm air bags, there is a salient massage with a magnetic massage function.
- There are five kinds of handrail shortcut button on the left armrest, on/off button, the calf frame lifting button, the linkage adjustment button, the automatic mode button, and the zero gravity button.
- The left and right handrails are equipped with LED mood lights.
- LCD Color screen controller.
- Turn off the chair, it return to siting position automatically, and the massage hand return to default position too.

Method of usage

LCD: display all massage functions.

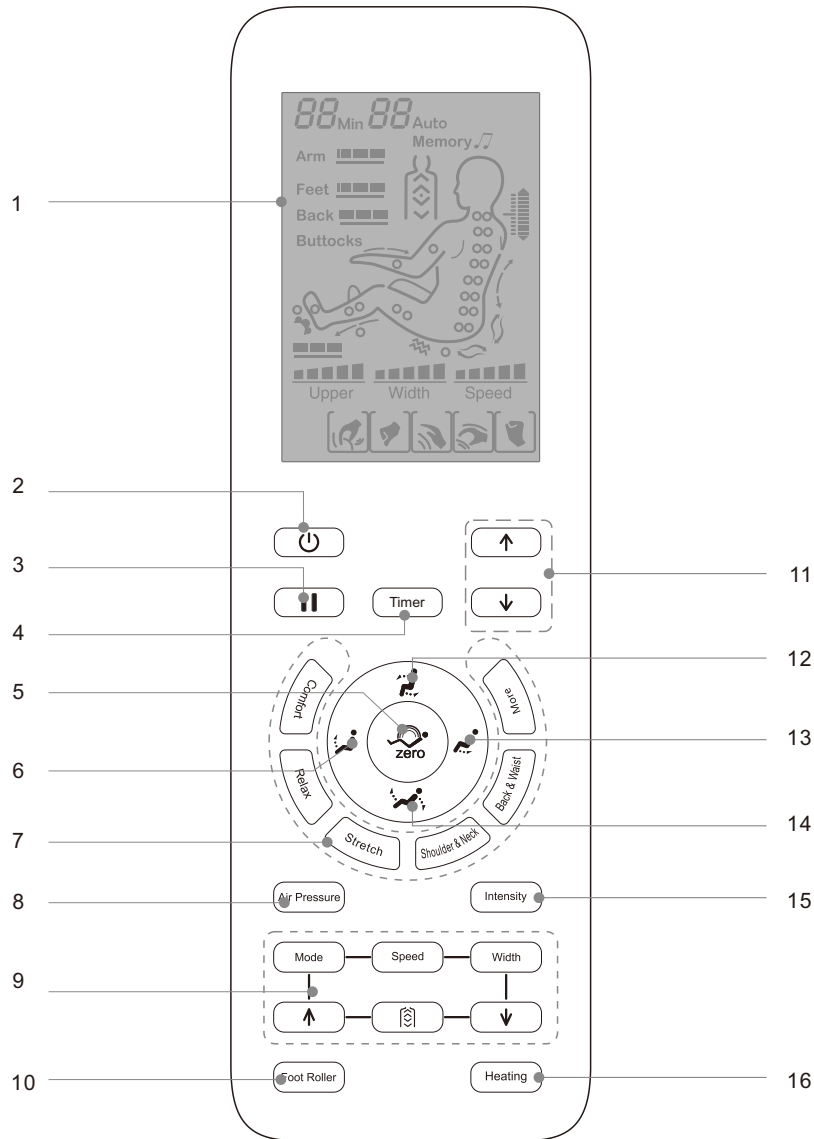

Method of usage

- 1.LCD:
 - Display all massage functions.
- 2.Power switch:
 - Turn on or off all massage functions.
- 3.Pause \ run button:
 - Pause or run all massage functions.
- 4.Timer button:
 - Sets the amount of time you want your chair to massage
- 5.Automatic reclining button:
 - There are three automatic reclining modes, which can automatically switch according to your own needs.
- 6.Footrest up button:
 - Adjust footrest up.
- 7.Automatic massage button:
 - Please refer to page 10 of this manual for details.
- 8.Air pressure mode button:
 - Turn on/off air pressure massage function (please refer to page 11 of this manual for details).
- 9.Manual massage button:
 - Please refer to page 11 of this manual for details.
- 10.Foot roller button:
 - Please refer to page 11 of this manual for details.
- 11.Shoulder adjustment button:
 - Manual adjustment of human shoulder position massage finger pressure point.
- 12.Sitting:
 - Adjust backrest frame rise and calf frame drop.
- 13.Calf frame down button:
 - Adjust calf frame down.
- 14.Reclining:
 - Adjust backrest frame to drop and footrest frame to rise.
- 15.Air pressure intensity button:
 - Adjust air pressure intensity.
- 16.Heating button:
 - On/off heating massage function.

Method of usage

1. Switch power supply on



2. Start to massage

- ①. Press power button to start massage, start comfort auto massage by default.
- ②. The massage chair recline automatically.
- ③. Automatic shoulder position detection, make sure sit on massage chair closely.
- ④. If you feel the chair didn't recognize your actual shoulder position, press the Shoulder Position Up or Down button to manually adjust the shoulder position. You can select from 10 levels. You have 10 seconds to make an adjustment. After 10 seconds, the massage starts automatically.

Note: In the progress of start massage function, you can select the auto massage function. Repeat select the same auto massage function, can skip the detection process and start to massage directly

Button	Description	Display
	Move the massage balls upward to a suitable position	
	Move the massage balls downward to a suitable position	

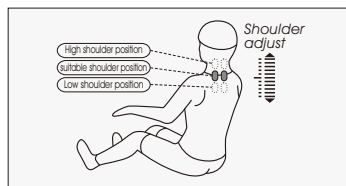

During the detection of shoulder massage and acupressure point process, (the hand controller screen has the shoulder position adjustment icon and the sound "Di,Di" can be heard from the hand controller, then press the shoulder position up and down button to adjust the shoulder position.) You can also choose any 12 kinds of automatic massage to enter the massage function (Comfort, Relax, Stretch, Shoulder & Neck, Back & Waist, Full body massage, Chiropractic massage, Fatigue recovery, Meridians massage, Beautiful buttock massage, Sleep peacefully massage and Full air pressure). (Can skip 4th step directly).











Method of usage

· Automatic massage







Function	Button	Description	Display
Automatic massage		Comfort: The most comfortable massage experience.	F1 Auto
		Easy: the depth of the soft and comfortable massage, relieve body fatigue	F2 Auto
		With the footrest and backrest up and down, plus air pressure massage function, stretch on your legs, Relieve fatigue, refresh yourself.	F3 Auto
		Shoulder & neck: focus on shoulder and neck massage.	F4 Auto
		Back & waist: massage focus on back waist	F5 Auto
		Full body massage: Deep tissue massage rejuvenate the body.	A1 Auto
		chiropractic massage: focus on chiropractic massage, relax body and mind.	A2 Auto
		Fatigue recovery: improve the whole body fatigue pain, for the back, limbs to achieve relaxation and improve microcirculation, quickly relieve fatigue.	A3 Auto
		Meridians massage: dredge meridians, quickly improve the body's microcirculation, enhance immunity.	A4 Auto
		Beautiful buttock massage: be aimed at buttock and thigh effective massage, beautify body shape, reduce the accumulation of redundant adipose body.	A5 Auto
		Sleep peacefully massage: through the twelve major health acupoints massage to help the body recuperate balance, quickly improve sleep, improve sleep quality.	A6 Auto
		Full air pressure: focus on the whole body pressure massage to fully relax the body, to the depth of the body massage, fully relieve fatigue and pain of the body.	A7 Auto

Method of usage

· Upper body manual massage

Function	Button	Massage ball adjustment	Display
Technique	Mode	Shiatsu: speed, width.	
		Kneading: speed.	
		Tapping: speed, width.	
		Kneading & tapping: speed.	
		Knocking: speed, width.	
Speed	Speed	5 speed adjustable.	
Width	Width	3 levels optional	
Back stretch	Back stretch	Fixed position and spot massage.	
		Small area local round trip massage.	
		A round trip massage.	
	↑	Message position adjustment (in fixed point and local mode, massage position can be adjusted).	Message roller up
↓		Message roller down	

· Pneumatic massage

Function	Button	Description	Display
Air pressure Mode	Air Pressure	Full pressure: air pressure massage on arms, legs and feet.	Arm  Feet 
		Arm: air pressure massage focus on arms	Arm 
		Leg: air pressure massage on footrest	Feet 
intensity	Intensity	3 levels adjustable	Arm  Feet 

· Foot roller massage

Function	Button	Description	Display
Foot roller	Foot Roller	Press on the button repeatedly to choose the intensity level of your choice (low, medium and fast) or off this function.	

Method of usage





· Heated massage

Function	Button	Description	Display
Heat	Heating	Press this button to turn on or off the back far infrared hyperthermia. Turn on 3 minutes later you will feel warm.	

· Pause/start message button

Function	Button	Description	Display
Pause/start	Pause	Press this button in the process of massage, and all massage movements will be suspended urgently when time continues to countdown), and then press this button resume all before suspended massage modes	

· Adjust lying Angle

Function	Button	Description
Backrest up and footrest down at the same time		Press and hold this button to slowly raise the back rest and lower the footrest at the same time. Release the button to stop at the desired massage angle.
Footrest up and backrest down at the same time		Press and hold this button to slowly raise the calf rest and lower the back rest at the same time. Release the button to stop at the desired height
Footrest up		Press and hold this button to slowly lift the footrest. Release the button to stop at the desired height
Footrest down		Press and hold this button to slowly lower the footrest. Release the button to stop at the desired height.
Lie down automatically		Press the button every time to switch one automatic lying mode. There are three modes in total.

· Other manual functions

Function	Button	Description	Display
Timer	Timer	Press on this button to add 5 minutes to the massage. Press repeatedly for up to 30 minutes	20min

Method of usage

3.Introduction of handrail shortcut keys

The left arm

Right arm

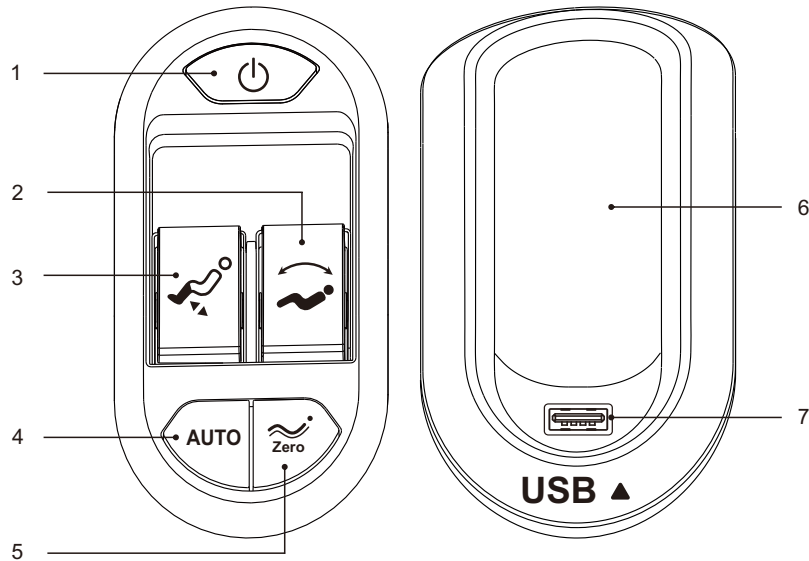





Left armrest shortcut:

- 1.Power button: Turn the massage chair on or off.
- 2.linkage adjustment button: linkage adjustment of the backrest and the footrest up and down.
- 3.Calf frame lifting button: adjust the footrest up and down.
- 4.Automatic button: turn on the automatic massage function.
- 5.Zero-gravity button: adjust to the zero-gravity angle of the massage chair.

Right armrest shortcut:

- 6.Place the slot: the hand controller and the mobile phone can placed in the slot.
- 7.USB charging port: smart device charging.

Method of usage

Function	Description
	Power button: Press this button to turn the massage function on or off.
	Footrest UP button. To adjust the footrest up, push this button. Release it for the desired angle.
	Footrest DOWN button. To adjust the footrest down, press this button. Release it for the desired angle.
	Footrest and backrest adjustment button. Press the button to move the backrest up and the footrest down slowly, the movement will stop once you release the button.
	To move the backrest down and the footrest up, lift the button, the movement will stop once you release the button
AUTO	Auto mode button: To enable the automatic massage functions, press repeatedly to choose your favourite massage.
	Zero gravity button: To adjust to the zero gravity preprogramed angles, press repeatedly this button to choose between 3 different angles
	USB jack: USB charging port, you can charge smart devices (such as mobile phones).

Method of usage

5. Bluetooth Player Operation

1. Enter the smart device manual and open the Bluetooth function to search the new Bluetooth devices .
2. Will find the bluetooth named like (BM-E1993-####), choose it to pair with the chair
3. Turn on the Music Player in the smart device .

6. Turn off the power and stop massage.

- When pressing the power button during the massage, it will stop all the massage functions immediately, the backrest and footrest will go back to the default posit on. And when the massage time up, the massage hand will go back to the default position, all the massage function will stop, the backrest and footrest will not go back to the default position.
- Cut off the power of the whole machine. Figure (switch power off)



7. The calf installation.

1. After connecting the air hose and the wire harness on the calf and the massage chair, untie the fixed line belt and insert the connecting part into the frame. (Figure 1).
2. Place the calf fixing block on the two sides of the round tubes of the calf (Figure 2).

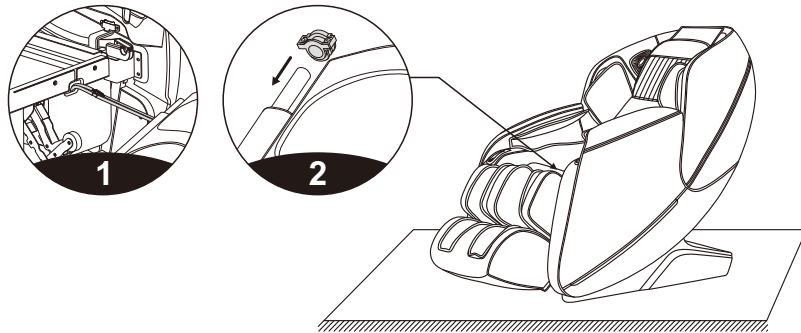

Method of usage

3. Hang the calf of the fixed block on the massage chair frame hook (Figure 3).
4. Then use 4 (each side two pcs) M4 screws to fasten the calf to the massage chair, check whether there is any abnormality, whether the pipeline is folded or not, and finish the installation (Figure 4).

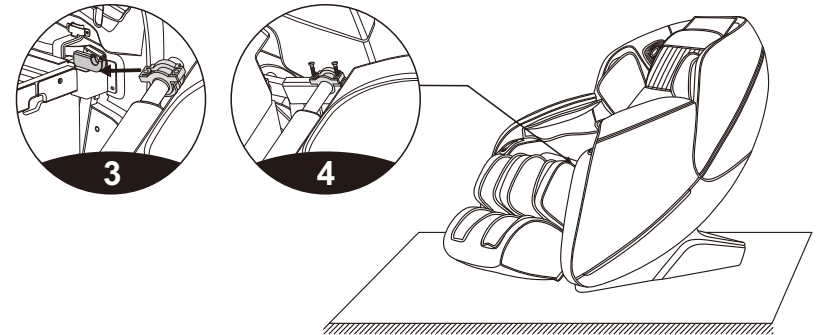

8. Head cushions and backrest pad's dismounting and use manual

- The head cushion allows you to contr ol the intensity of the neck and shoulder massage, You can decide whether to use the head cushion (Recommend to use). The backrest cushion and the backrest is connected by zipper (1), head cushion and the backrest cushion connected by the Velcro as show in the illustration (2).

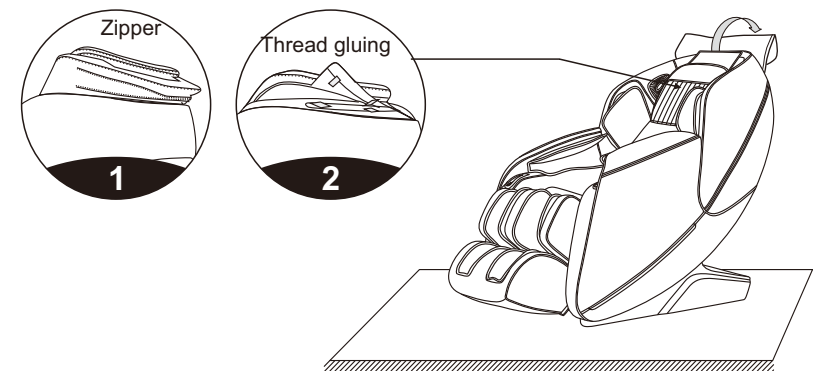

Method of usage

9. Floor Protection

- Put the heavy massage chairs on the wood floor for a may damage the floor, so please place a carpet or other object to avoid this damage.

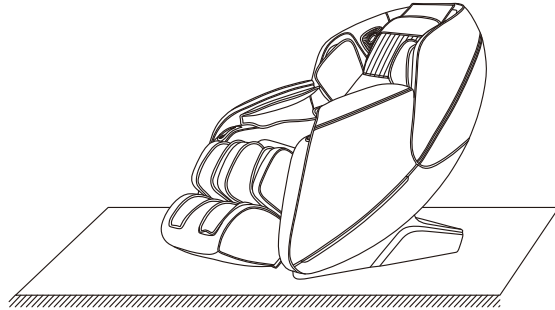

Caution: Do not move the chairs with its wheels on wood floor, rough ground or in a narrow space. Two people are required to lift the chair. During the lifting period, take the calf rest end sealing plate and backrest cover grooves as the force-bearing point(Please do not lift armrest directly.)

10. Method of movement

- Make sure that the power cord took off from the chair, tilt the backrest backward to a certain degree (with the gravity center resting on the casters), push the chair forward or backward with your hands and finally resume the chair to the normal position in a slow and gentle manner.(Note: During movement you must turn off the power first and then unplug the power cord and the controller cord.)

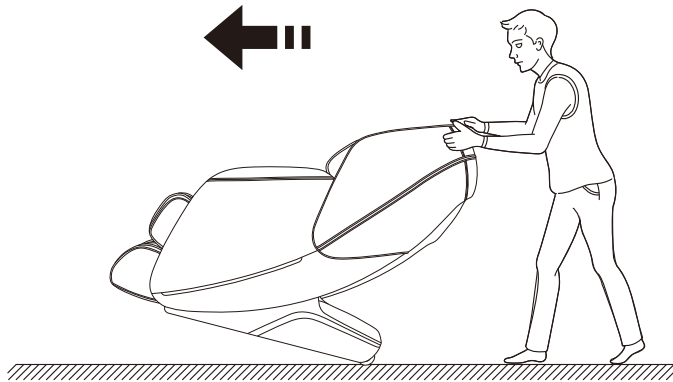

Warning : Massage casters wheels are only suitable for short distance movement for long distances, please use other assistive tools to move the massage chair.

Product specification

Model: BM-E1993

Name: Massage Chair

Rated voltage: 110-120V~ 60Hz

220-240V~ 50Hz/60Hz

Rated power input:120W

Rated time: 20Min

Safety structure: Class I

Material introduction: PVC, PA, steel parts and electric & electron parts

MATERIAL	PU	LEATHER	CLOTH	WOOD

