

BenchmasterR ASSEMBLY INSTRUCTIONS

SINGLE LEVEL UNIT

Oil all sockets before assembly

Components:
BMS361801S-36"

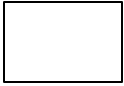

Solid Top Panels: (1) - 24"x36"
Legs: (4) - 18" legs

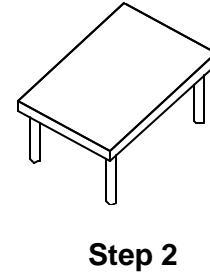
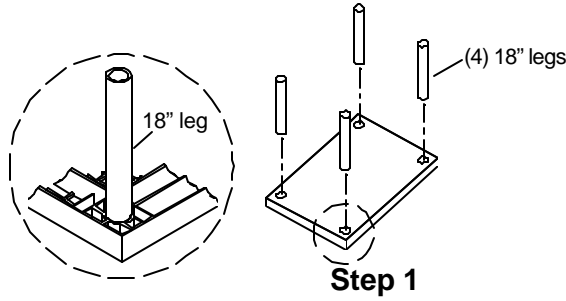

Components:
BMS661801S-66"



Solid Top Panels: (1) - 24"x66"
Legs: (6) - 18" legs

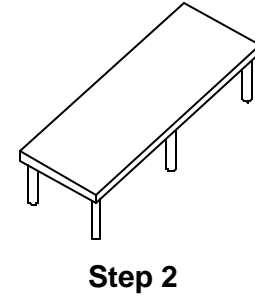
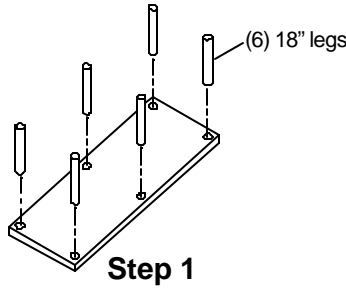

Components:
BMS961801S-96"

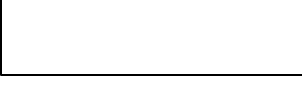

Solid Top Panels: (1) - 24"x96"
Legs: (8) - 18" legs

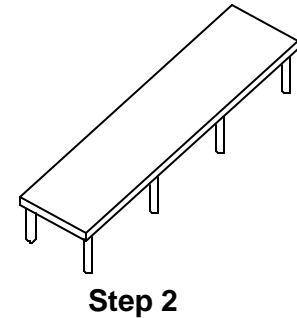
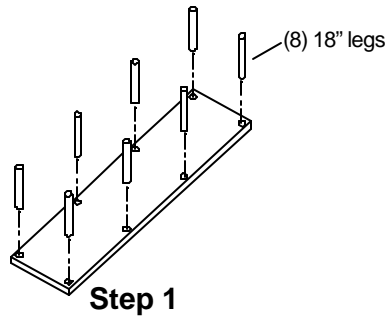

Components:
BMS661801S3-66"



Solid Top Panels: (1) - 36"x66"
Legs: (8) - 18" legs

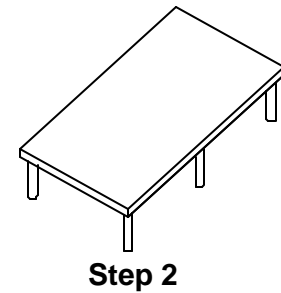
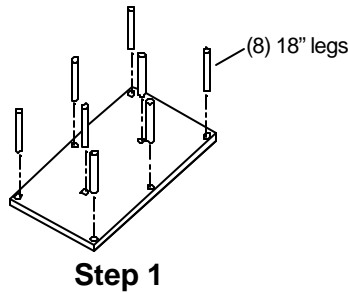

Components:
BMS961801S3-96"



Solid Top Panels: (1) - 36"x96"
Legs: (11) - 18" legs

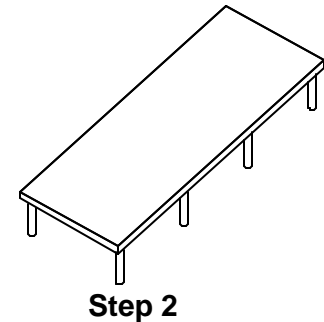
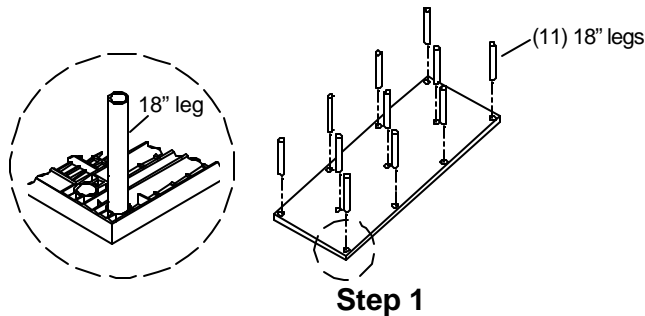

Step 1

Invert panel and place **18" legs** as shown.
(Make sure legs are pushed all the way down).

Step 2

Return bench to upright position.