

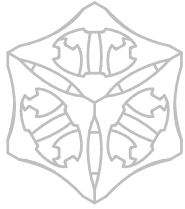





Orbital Express Piece Count: Orion, 20' x 20' Kit Size

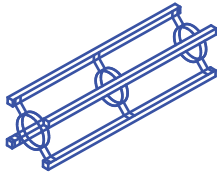

Thank you for your purchase of Orbital Expo Truss Extreme. These instructions show how erect the kit you purchased. The color coded section will help identify the location of each part.

 <p>6-WAY JUNCTION BOX (OR-J-2) 32</p>	 <p>46" LONG TRUSS SECTION (OR-46-2) 14</p>	 <p>UNIVERSAL CONNECTOR (OR-UNI-CLP-1) 0</p>	 <p>SPOTLIGHT (CHOICE OF LIGHTS) 12</p>	<p>(OR-IS-24-S/WD*) 24" 0</p> <p>(OR-IS-36-S/WD*) 36" 0</p> <p>(OR-IS-46-S/WD*) 46" 0</p> <p>INTERNAL SHELVES</p>
 <p>24" LONG TRUSS SECTION (OR-24-2) 0</p>	 <p>45 CURVED TRUSS SECTION (OR-45-CV-2) 0</p>	 <p>ADJUSTABLE TABLE TOP (OR-TBL-S/WD*) 6</p>	 <p>TRUSS TO JUNCTION CONNECTION KIT (OR-QL-T2J) 109</p>	 <p>ORBITAL FREIGHT CASE (OCF) 1</p>
 <p>36" LONG TRUSS SECTION (OR-36-2) 20</p>	 <p>90 CURVED TRUSS SECTION (OR-90-CV-2) 32</p>	<p>LEFT (OR-TBL2-L-S/WD*) 0</p> <p>RIGHT (OR-TBL2-R-S/WD*) 0</p> <p>ADJUSTABLE SCALLOP TABLE TOP 0</p>	 <p>TRUSS TO TRUSS CONNECTION KIT (OR-QL-T2T) 16</p>	 <p>ORBITAL FREIGHT CASE (OCT) 3</p>

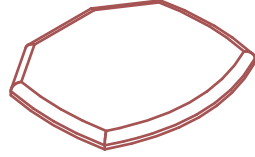
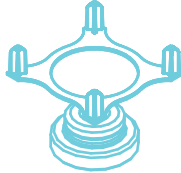
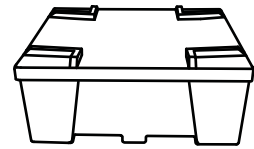
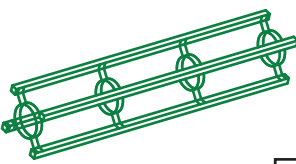
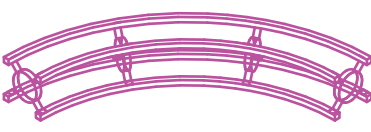
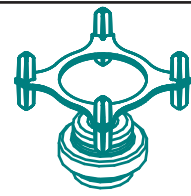
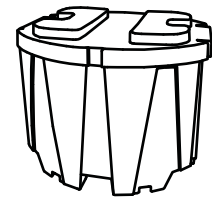
Each Orbital Truss Extreme kit has been carefully designed and developed to be stable and safe. Consult with your dealer for load bearing specifications. The manufacturers of Orbital Expo Truss Extreme will not be held responsible or accountable for damage or injury caused by exceeding guidelines or through wrongful/incorrect use of the system. NOTE: S = Brushed Silver Finish, WD = American Natural Wood Finish.

Kits will come with choice of lights except for Lumina 2.

Graphic Specs & Art Guidelines: Orion, 20' x 20' Kit Size

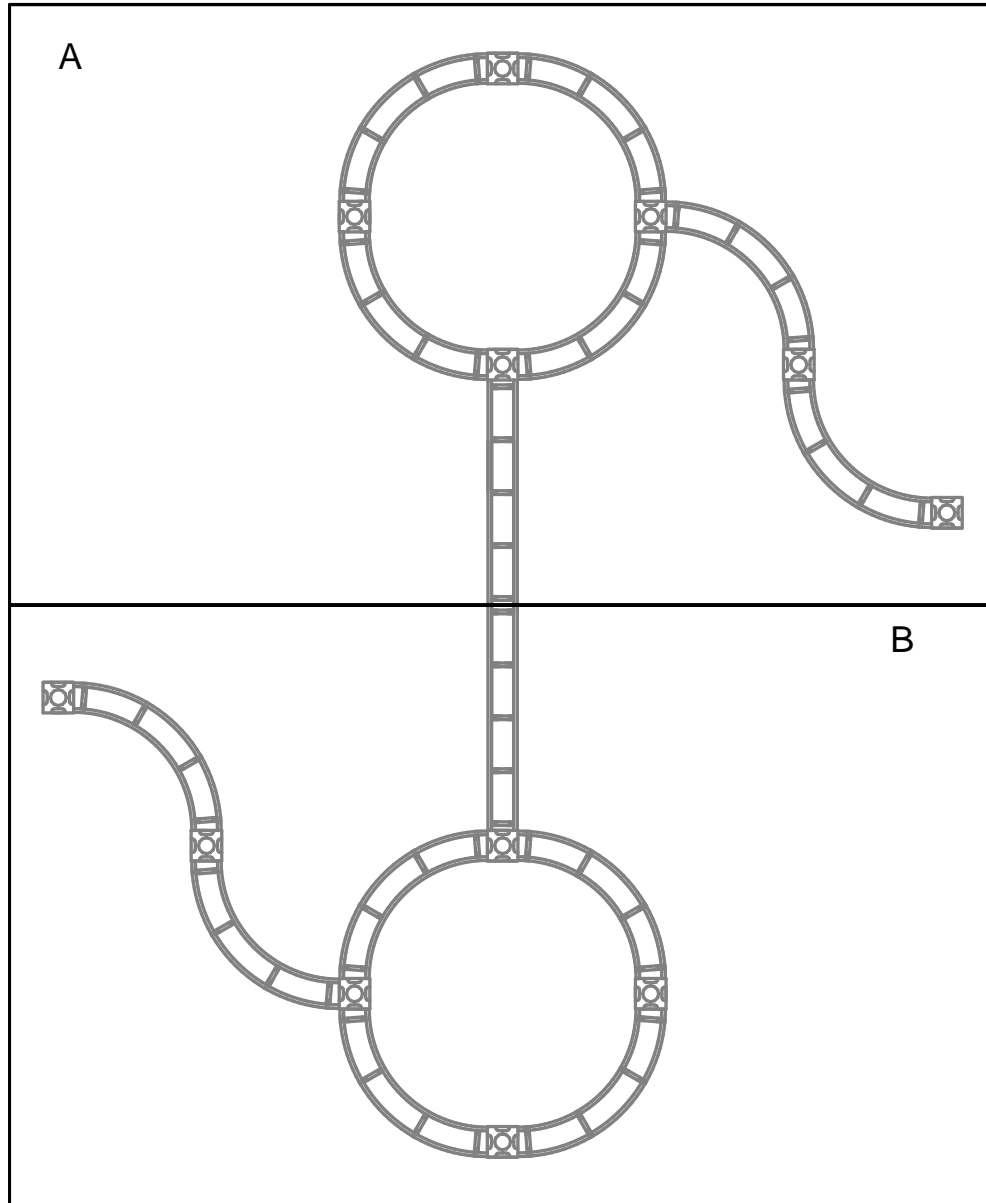

IMPORTANT INFORMATION REGARDING GRAPHIC FILES: Each graphic has a specific code or number located on the graphic. The electronic print ready files provided must be named accordingly. Using this coding system will allow us to preflight and prepare your files for print more efficiently. **If you fail to provide your graphic files in this format, additional charges may be necessary to complete your printed materials.**

Graphic Specs & Art Guidelines: Orion, 20' x 20' Kit Size

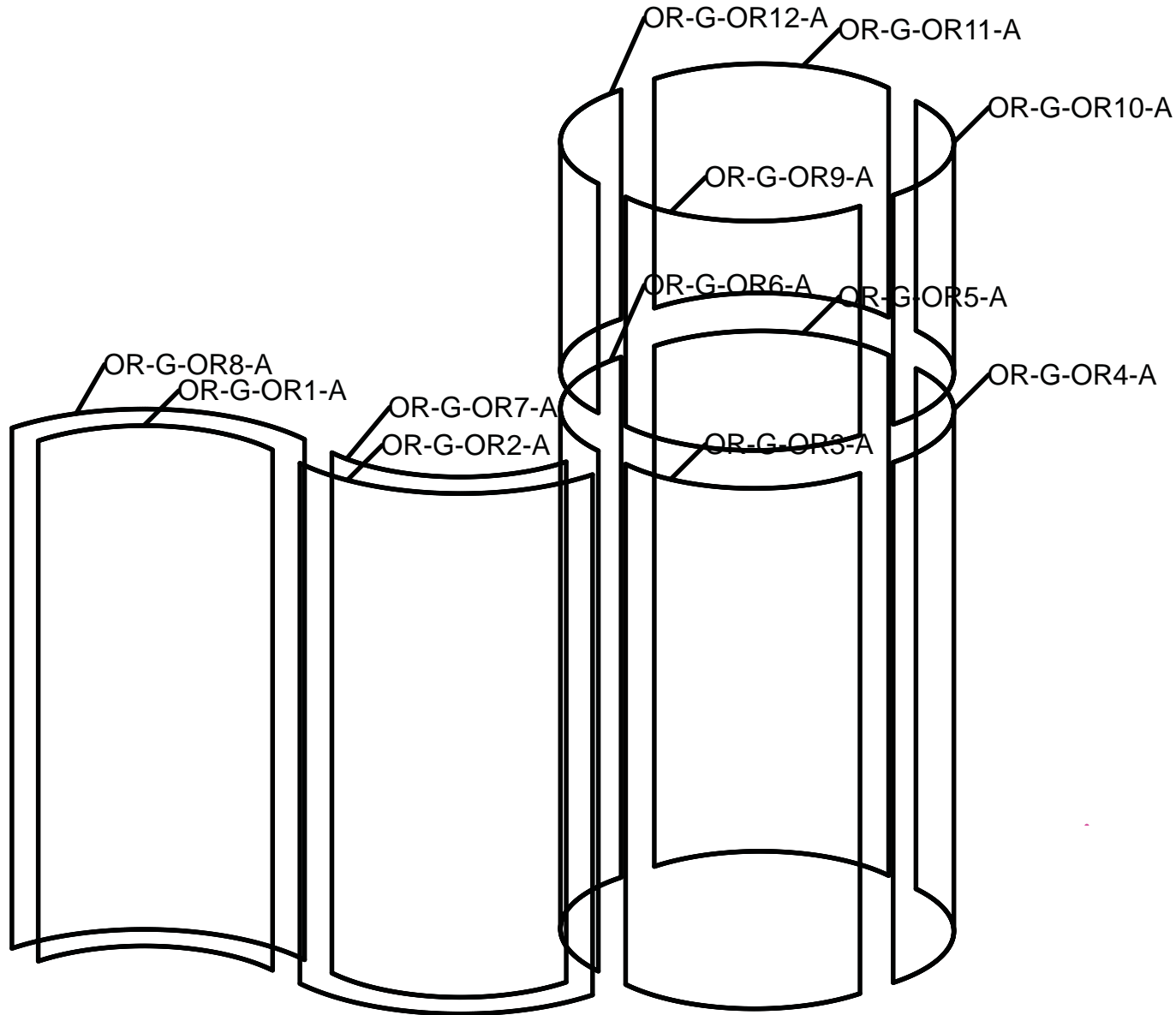

IMPORTANT INFORMATION REGARDING GRAPHIC FILES: Each graphic has a specific code or number located on the graphic. The electronic print ready files provided must be named accordingly. Using this coding system will allow us to preflight and prepare your files for print more efficiently. **If you fail to provide your graphic files in this format, additional charges may be necessary to complete your printed materials.**

Graphic Specs & Art Guidelines: Orion, 20' x 20' Kit Size

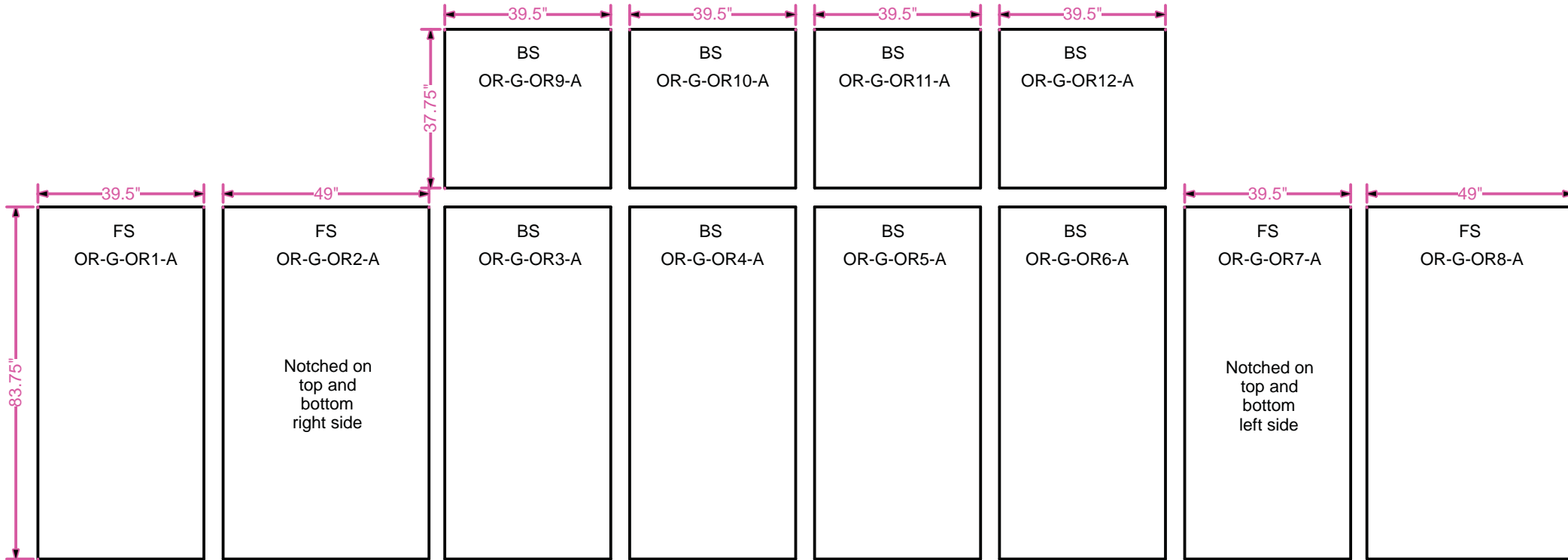

Available Graphics:

Dye-sublimation, or
Inkjet Graphics Only

Acceptable File Formats:

Illustrator CS3 or below
Photoshop CS3 or below

Art time will be charged if files need to be fixed or altered to meet guidelines. When sending files please be sure to include all support art (fonts, linked images, etc.)

Font Specifications:

Fonts must be converted to outlines.

Bleeds:

All orbital truss graphics require specific bleeds. The sizes listed above represent the finished graphic size. Please keep all logos, type, and critical information at least 1" in from each edge of the finished graphic.

Dye Sublimation: 2" bleed around the perimeter.

Inkjet & UV: 1/2" bleed around the perimeter.

Color:

All files are printed as CMYK format. All critical Pantone colors need to be called out in the file or specified on the order as Coated or Uncoated swatches.

Resolution:

All raster files (either print files or linked files) must be at 100-120 pixels per inch at 100%.

Finishing Details:

When graphics are notched, a 7/8" square is cut in the appropriate location

FS: Graphics mounted to front of the truss system
BS: Graphics mounted to back of the truss system

Dye Sublimation graphics are attached to truss with velcro. Inkjet & UV panels are attached to truss with magnet.

IMPORTANT INFORMATION REGARDING GRAPHIC FILES: Each graphic has a specific code or number located on the graphic. The electronic print ready files provided must be named accordingly. Using this coding system will allow us to preflight and prepare your files for print more efficiently. **If you fail to provide your graphic files in this format, additional charges may be necessary to complete your printed materials.**

Graphic Specs & Art Guidelines: Orion, 20' x 20' Kit Size

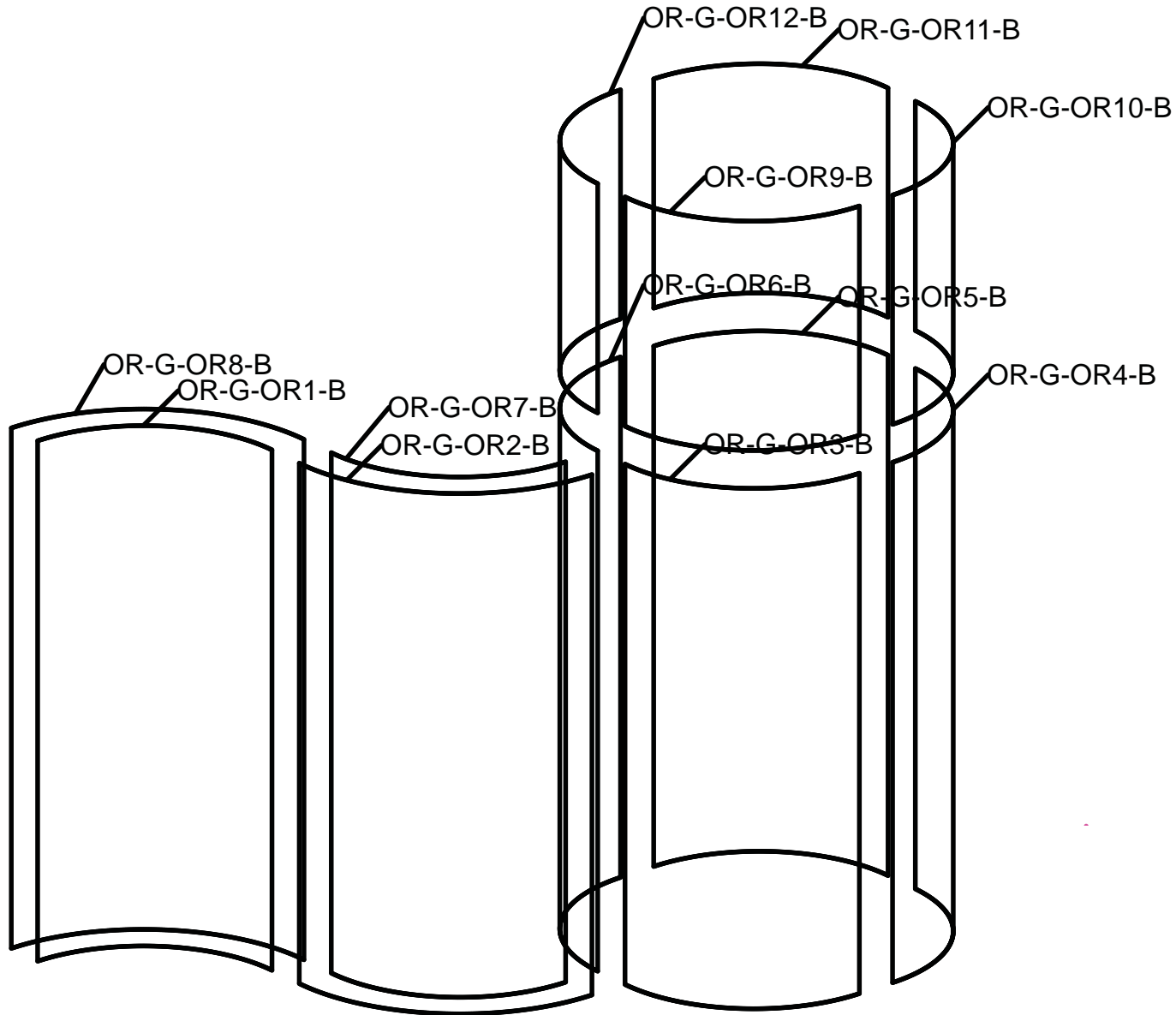

IMPORTANT INFORMATION REGARDING GRAPHIC FILES: Each graphic has a specific code or number located on the graphic. The electronic print ready files provided must be named accordingly. Using this coding system will allow us to preflight and prepare your files for print more efficiently. **If you fail to provide your graphic files in this format, additional charges may be necessary to complete your printed materials.**

Graphic Specs & Art Guidelines: Orion, 20' x 20' Kit Size

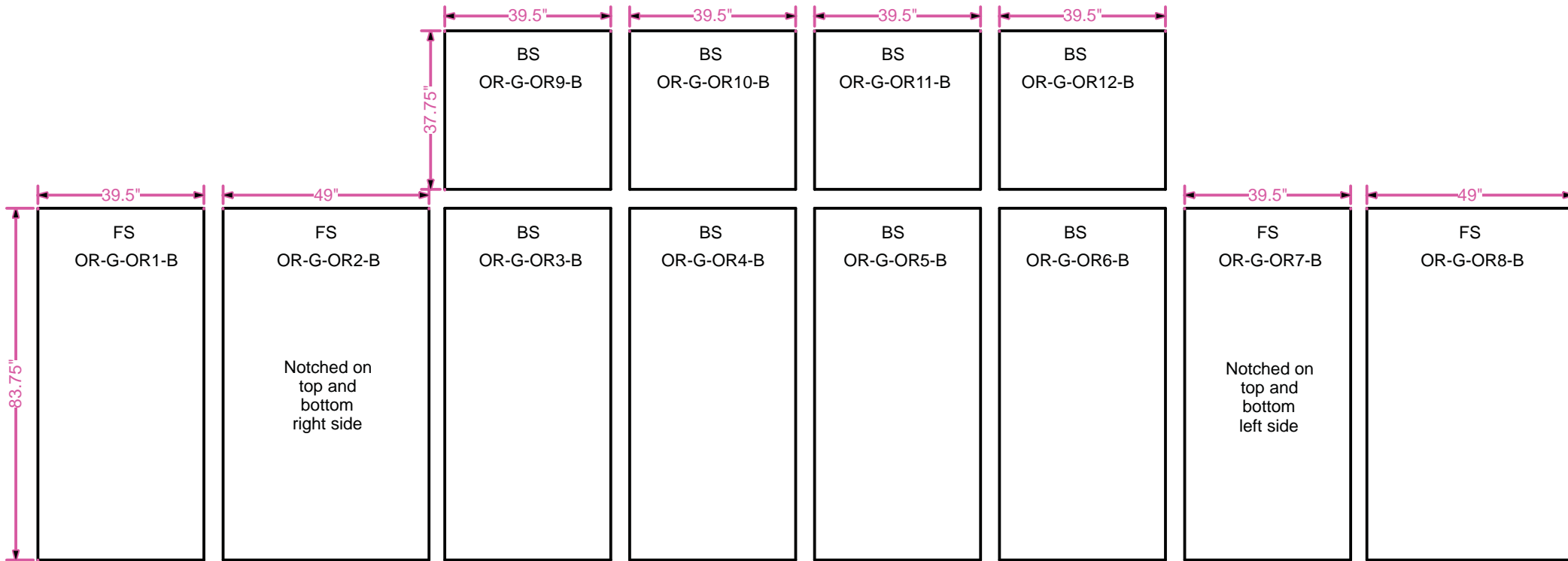

Available Graphics:

Dye-sublimation, or
Inkjet Graphics Only

Acceptable File Formats:

Illustrator CS3 or below
Photoshop CS3 or below

Art time will be charged if files need to be fixed or altered to meet guidelines. When sending files please be sure to include all support art (fonts, linked images, etc.)

Font Specifications:

Fonts must be converted to outlines.

Bleeds:

All orbital truss graphics require specific bleeds. The sizes listed above represent the finished graphic size. Please keep all logos, type, and critical information at least 1" in from each edge of the finished graphic.

Dye Sublimation: 2" bleed around the perimeter.

Inkjet & UV: 1/2" bleed around the perimeter.

Color:

All files are printed as CMYK format. All critical Pantone colors need to be called out in the file or specified on the order as Coated or Uncoated swatches.

Resolution:

All raster files (either print files or linked files) must be at 100-120 pixels per inch at 100%.

Finishing Details:

When graphics are notched, a 7/8" square is cut in the appropriate location

FS: Graphics mounted to front of the truss system

BS: Graphics mounted to back of the truss system

Dye Sublimation graphics are attached to truss with velcro. Inkjet & UV panels are attached to truss with magnet.

IMPORTANT INFORMATION REGARDING GRAPHIC FILES: Each graphic has a specific code or number located on the graphic. The electronic print ready files provided must be named accordingly. Using this coding system will allow us to preflight and prepare your files for print more efficiently. **If you fail to provide your graphic files in this format, additional charges may be necessary to complete your printed materials.**

3D Rendering: Orion, 20' x 20' Kit Size



3D Rendering: Orion, 20' x 20' Kit Size



Color Coded Components: Orion, 20' x 20' Kit Size

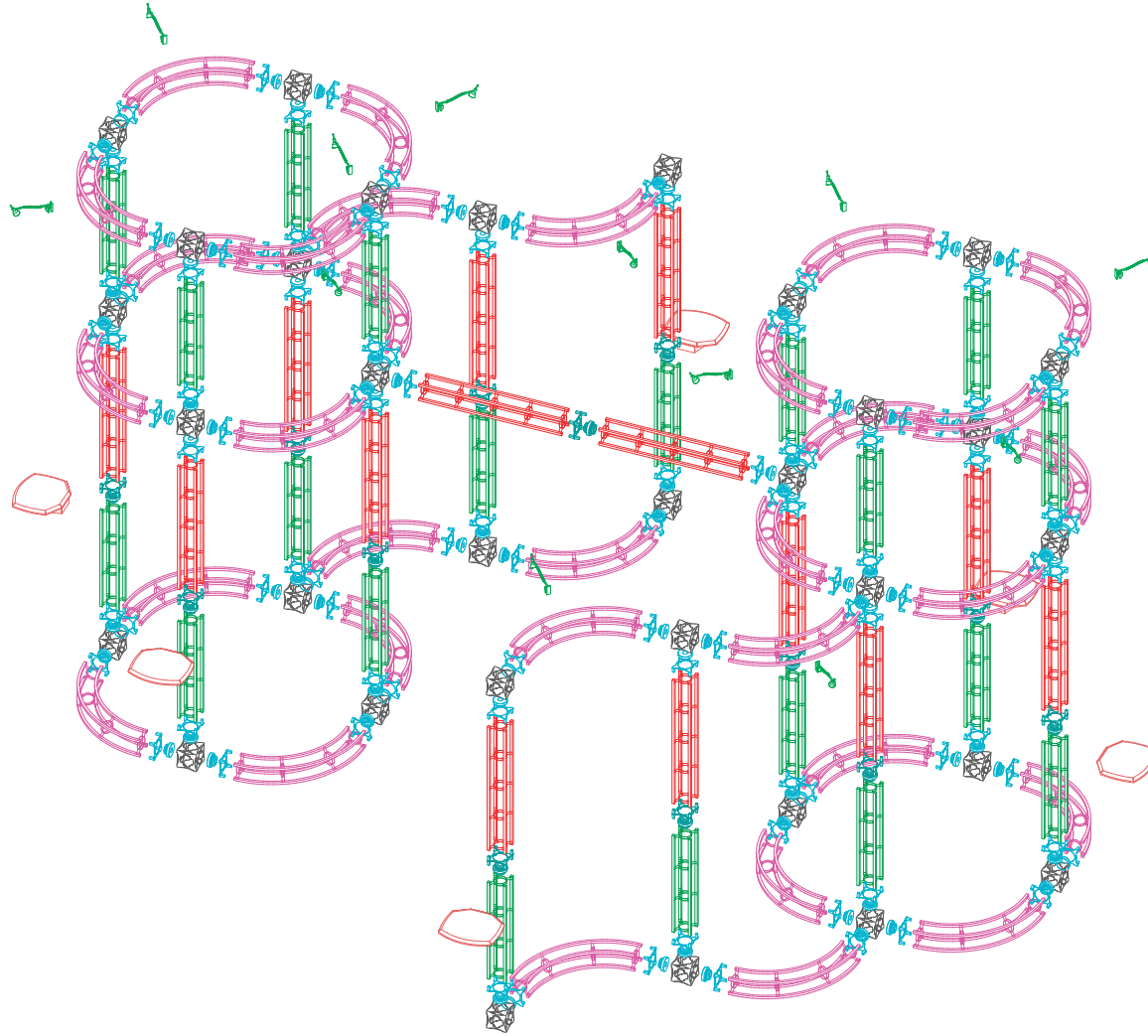

6-WAY
JUNCTION BOX

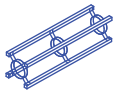

24" LONG
TRUSS SECTION

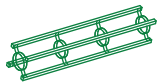

36" LONG
TRUSS SECTION

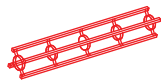

46" LONG
TRUSS SECTION

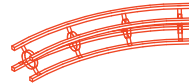

45 CURVED
TRUSS SECTION

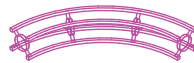

90 CURVED
TRUSS SECTION



ADJUSTABLE
TABLE TOP



50 WATT CHROME
SPOTLIGHT



INTERNAL
SHELVES



UNIVERSAL
CONNECTOR



TRUSS TO TRUSS
CONNECTION KIT



TRUSS TO JUNCTION
CONNECTION KIT

Color Coded Components: Orion, 20' x 20' Kit Size

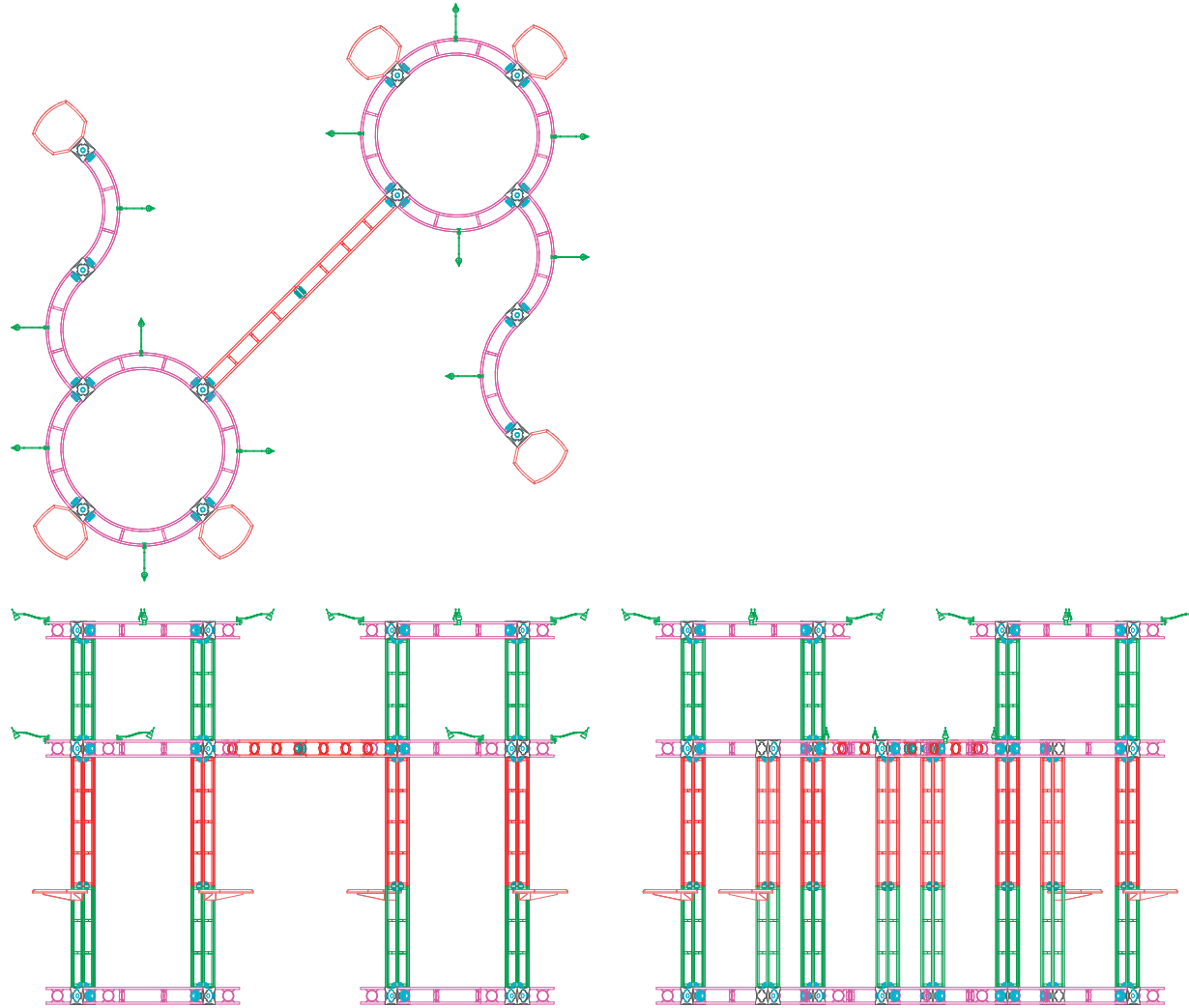

6-WAY
JUNCTION BOX

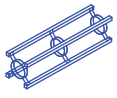

24" LONG
TRUSS SECTION

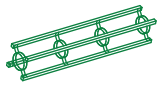

36" LONG
TRUSS SECTION

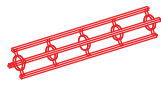

46" LONG
TRUSS SECTION

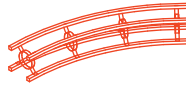

45 CURVED
TRUSS SECTION

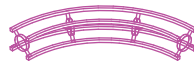

90 CURVED
TRUSS SECTION



ADJUSTABLE
TABLE TOP



50 WATT CHROME
SPOTLIGHT



INTERNAL
SHELVES



UNIVERSAL
CONNECTOR



TRUSS TO TRUSS
CONNECTION KIT



TRUSS TO JUNCTION
CONNECTION KIT