

THESE VIEWS NOT SHOWN FULL SIZE

1/4 SCALE PIPER CUB
FOR Balsa USA

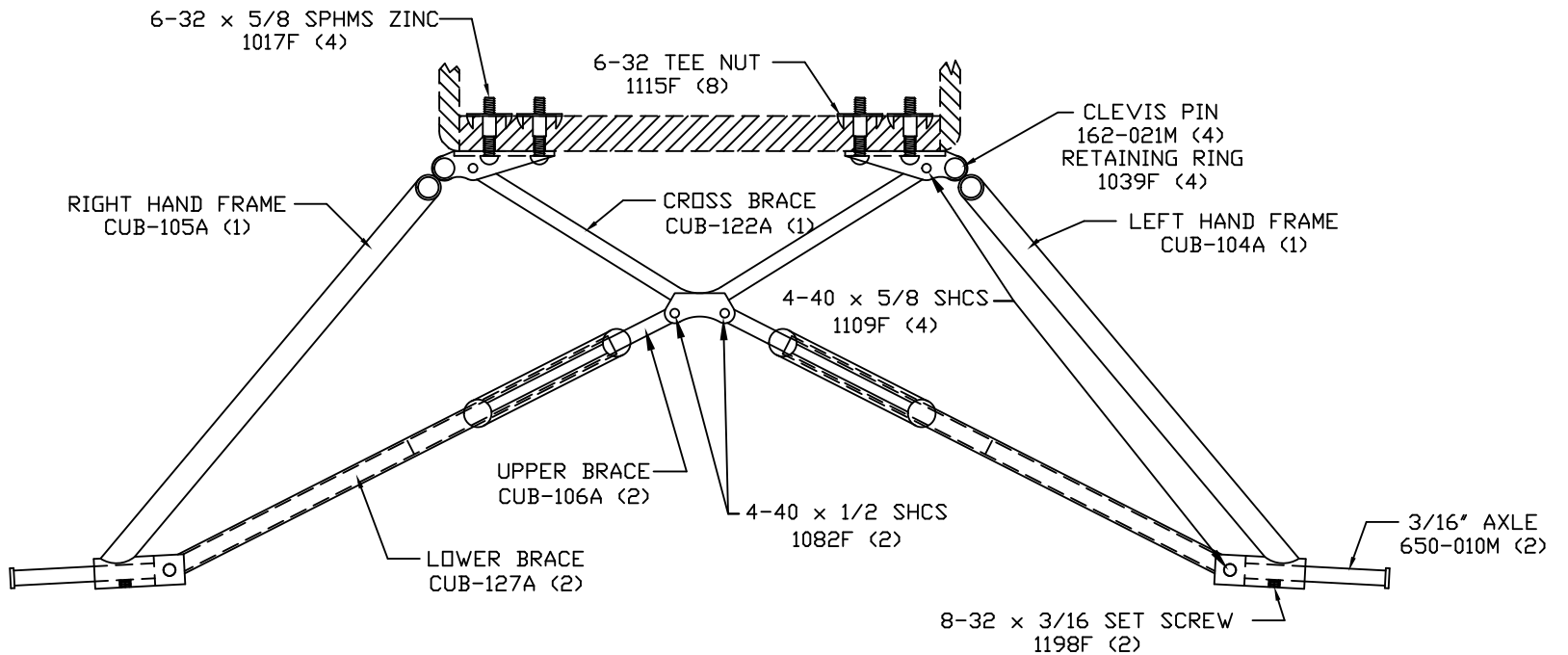

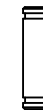
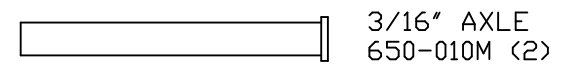
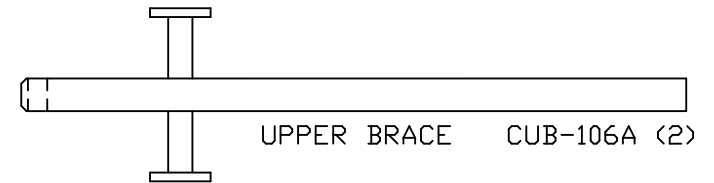
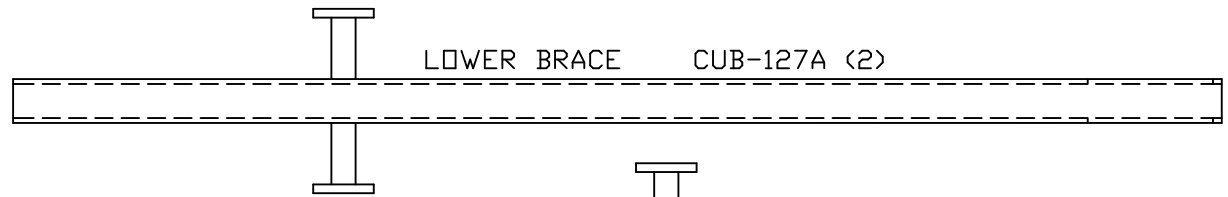

CLEVIS PIN
162-021M (4)

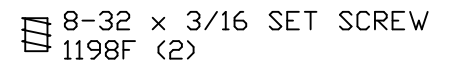

8-32 x 3/16 SET SCREW
1198F (2)



RETAINING RING
1039F (8)



4-40 x 1/2 SHCS
1082F (2)



6-32 TEE NUT
1115F (8)



4-40 x 5/8 SHCS
1109F (4)

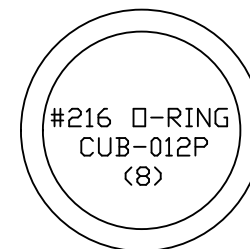

#216 O-RING
CUB-012P
(8)



6-32 x 5/8 SPHMS
1017F (8)



4-40 NYLON INSERT HEX NUT
1049F (6)



INSTALLATION INSTRUCTIONS:

THIS CUB GEAR HAS BEEN DESIGNED TO FIT THE 1/4 SCALE Balsa USA CUB WITH A FUSELAGE WIDTH OF 7 1/4 TO 7 3/8 INCHES. CHECK YOUR PLANS OR 3 VIEWS TO FIND THE PROPER POSITION OF THE FRONT GEAR STRUT FROM THE FIRE WALL AND USE THAT TO LOCATE THE FRONT MOUNTING HOLES. IF YOU ARE REPLACING EXISTING GEAR, YOU MAY USE THE EXISTING GEAR TO FIND THAT LOCATION. TURN YOUR FUSELAGE OVER, MARK THE CENTERLINE OF THE FUSELAGE AND THE LOCATION OF THE FRONT GEAR STRUT, POSITION AND TAPE THE TEMPLATE ON THE CENTERLINE AND MARK THE HOLE LOCATIONS AS SHOWN. IF YOUR PLANE DOES NOT HAVE A PLYWOOD FLOOR YOU WILL NEED TO ADD A 1/4" AIRCRAFT PLYWOOD MOUNT INSIDE THE FUSELAGE. AFTER MAKING THE NECESSARY CHANGES IF ANY TO THE FUSELAGE FLOOR, DRILL 11/64" DIAMETER HOLES AT THE LOCATIONS MARKED ON THE OUTSIDE OF THE FUSELAGE BOTTOM. USING THE TEE NUTS AND SCREWS PROVIDED MOUNT THE GEAR BRACKETS TO THE BOTTOM OF YOUR PLANE (NOTE YOU MAY WANT TO PAINT AND COVER YOUR GEAR PRIOR TO ASSEMBLY). ASSEMBLE YOUR GEAR AS SHOWN IN THE TWO VIEWS. ATTACH THE O-RING BUNGEE CORDS, FOUR ON EACH STRUT. BUNGEE COVERS CAN BE MADE FROM FABRIC, Balsa WOOD, FIBERGLASS, OR RUBBER.

1/4 SCALE PIPER CUB
FOR Balsa USA