



16-002/16-003

6 INCH

A-ARM LIFT KIT

WILL FIT CLUB CAR® DS®

INSTALLATION INSTRUCTIONS

INCLUDED:



Main Suspension Assembly



Spindles



A-Arms



Rear Lift Blocks
Rear Shock Mounting Plates



U-Bolts

WARNING:

After installing this lift kit, the front wheels must be properly aligned. Failure to properly align the front wheels may result in decreased ability to control the Golf Cart which may result in a rollover or crash.

1

Place RUN/TOW switch in TOW position and apply parking brake. Using a jack, lift cart and place jack stands underneath the cart on the frame.



2

Remove factory cowl and front bumper.

3
Remove front wheels.

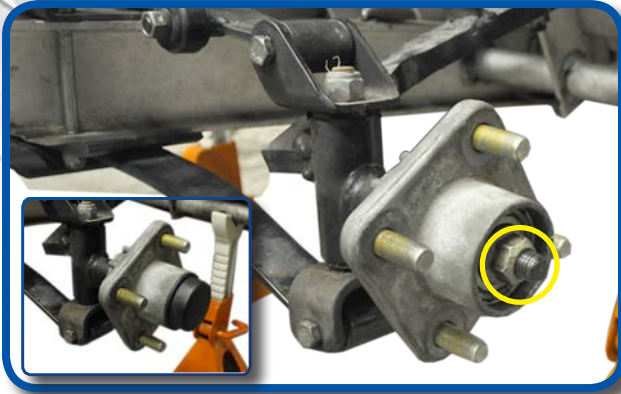

4
Remove dust cap, then remove nut from spindle. Retain hub and hardware.

5
Remove lower shock mounting bolt and nut on driver and passenger side. Shock does not need to be completely removed, only the lower bolt so the shock can be pushed up and out of the way.



6
Remove A-Arm bolt from factory spindle on both sides.



7
Remove the four factory A-arm bolts and nuts. Remove the factory A-arms.

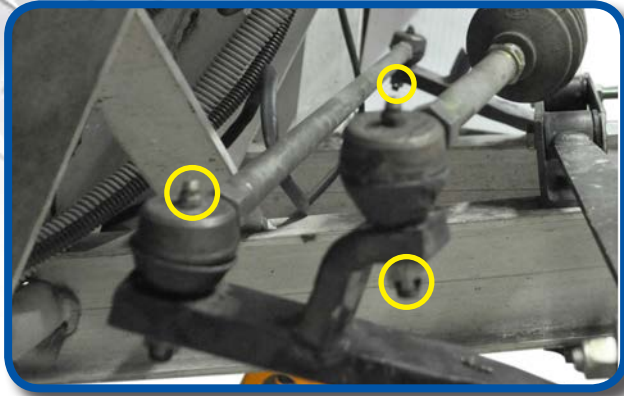
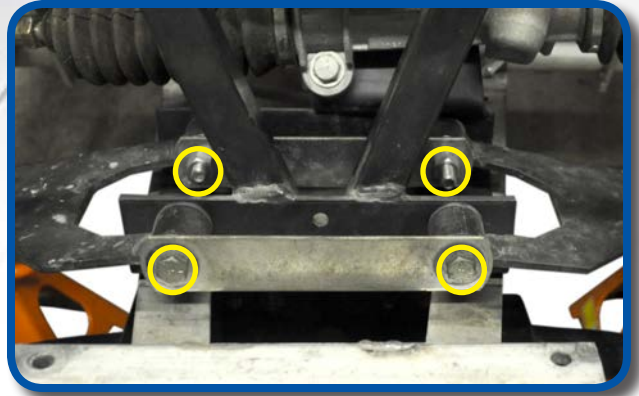

8
Remove the three castle nuts from steering linkage and retain all hardware.

9
Remove the four bolts to detach factory suspension assembly and retain hardware. Factory suspension assembly not be used.



10
Attach the Main Suspension Assembly using hardware retained from Step 9 and tighten.



11

Make sure the heim joints are tightened all the way in to the A-Arm Assembly such that no thread showing and tighten lock nut.

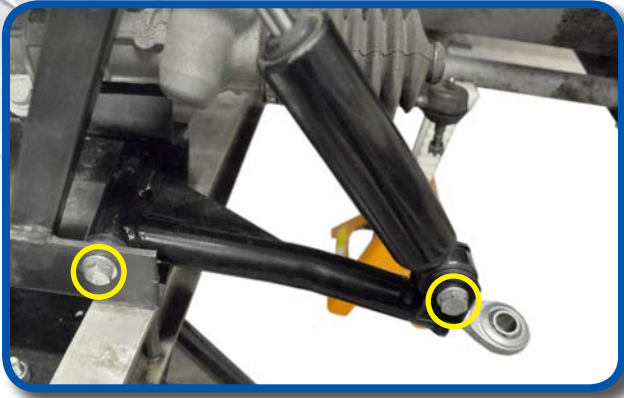

Attach A-arm to shock and to factory bracket using supplied hardware and tighten.

12

Attach spindles on both sides using hardware provided and tighten. Be sure to use provided thread locking adhesive on the bolts that attach the spindles.

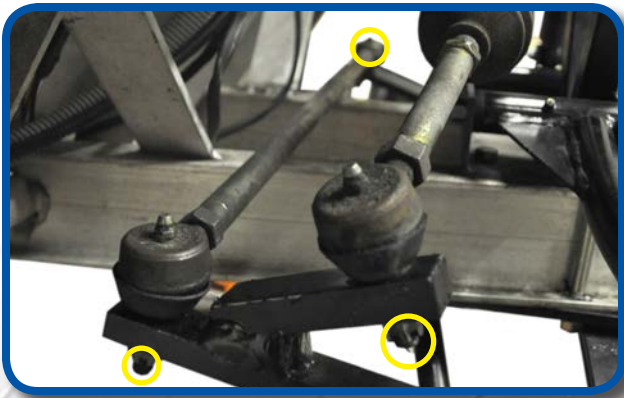

Attach steering linkage to upper portion of spindles on both sides using hardware retained from Step 8 and tighten.

14

15
Reattach hub and dust cap using hardware retained from Step 4.



16
Install wheels, front cowl and bumper.

17
Chock front wheels. Lift up the rear of the cart using a jack. Use jack stands on the frame of the cart on each side to hold it up. Remove rear wheels.



18
Loosen the factory passenger side shock and U-bolt. Do not completely remove the factory U-bolt; only loosen as shown.

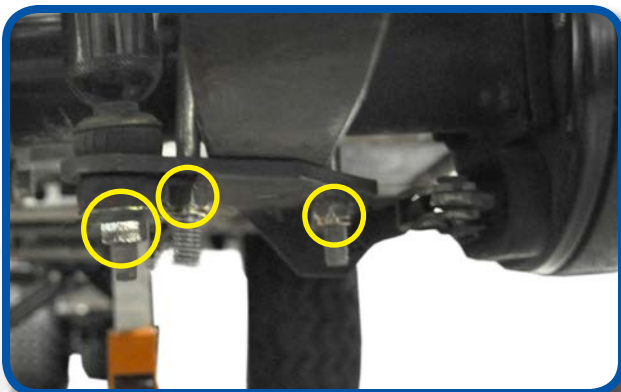

Place jack under rear end as shown. The jack is required to lower the rear end to complete the following steps.

IMPORTANT: Only apply enough pressure to keep the rear end and motor from falling; do not lift cart.

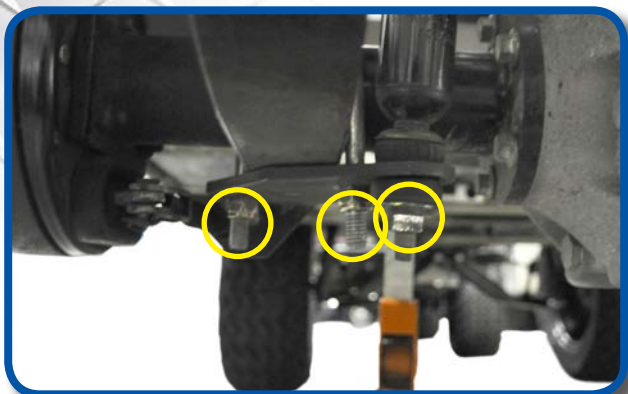
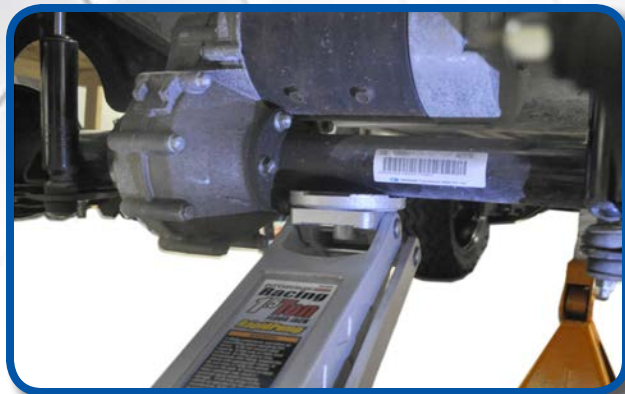

Remove nut from shock and factory U-bolt on driver's side.

21

Remove rear hardware from leaf spring and retain.



22

Remove front hardware from leaf spring and retain.

Use the jack to lower the rear end. Reposition spring above the axle and remount to factory mounting points using retained hardware from Steps 21 and 22.



Be sure block tilts toward front of cart

Place the rear shock mounting plate on top of leaf spring. Insert the lift block between the leaf spring and axle and then insert the provided U-bolt through top of the rear shock mounting plate. Attach shock to rear shock mounting plate.

Attach bolt from hardware pack through the factory lower bracket. This bolt does not serve as a fastener, its only purpose to provide the proper placement of the bracket in the new assembly. Tighten all hardware.

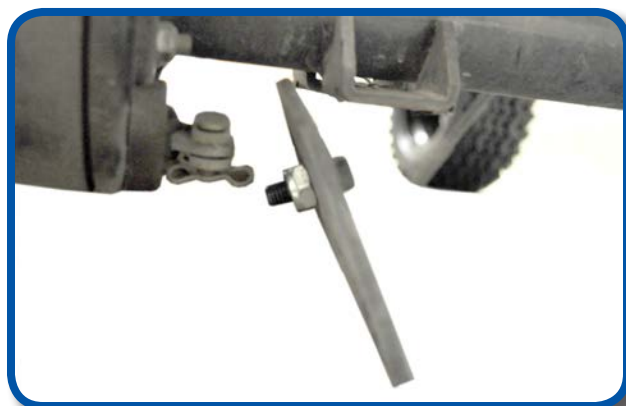

Attach factory lower bracket to U-bolts being sure that the bolt from step 25 fits properly into the hole in the axle.

Use the jack to lower the rear end. Tighten hardware. Repeat steps 20 through 26 on the passenger side.

Reinstall wheels.

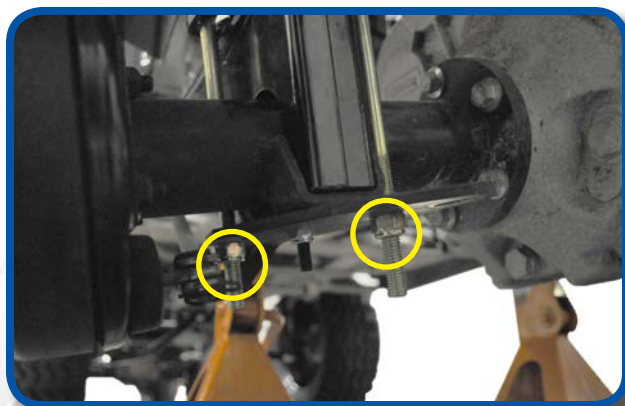

ALIGNMENT INSTRUCTIONS

WARNING:

After installing this lift kit, the front wheels must be properly aligned. Failure to properly align the front wheels may result in decreased ability to control the Golf Cart which may result in a rollover or crash.

IMPORTANT: Both Camber and Toe must be adjusted on this model.

Once installation is complete and the wheels have been reinstalled, roll the cart forward 5-6 feet.

Ensure the wheels are pointing straight forward. To adjust Toe, find a common point to measure from on the inside front and inside rear of the front tires. Adjust until the front measurement is 1/4" to 3/8" greater than the rear measurement.

To adjust for proper camber, use a framing square, level, or some other means of verifying that the tire is at a 90 degree angle to the ground.

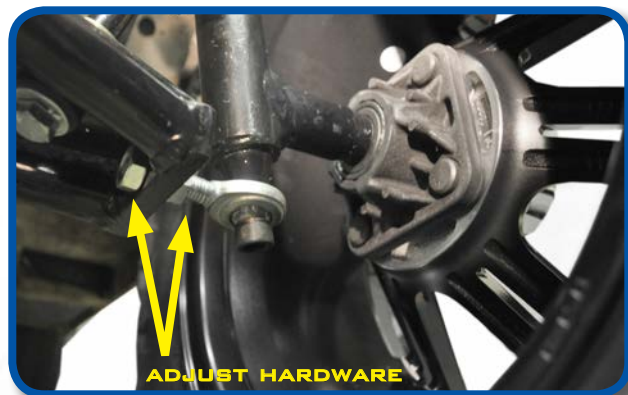
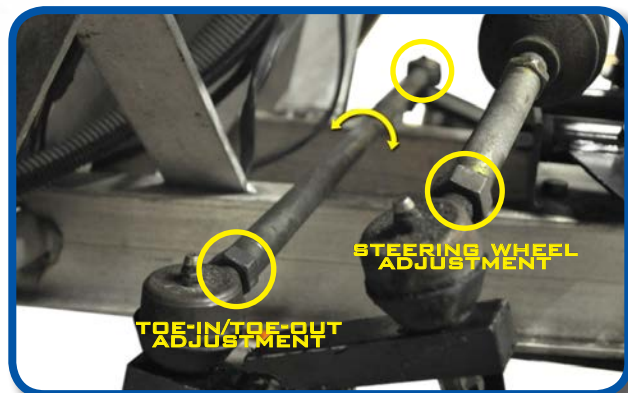

To adjust toe-in/toe-out, loosen nut on both tie rod ends. Adjust using a wrench to desired alignment.

If steering wheel is not properly oriented after adjusting toe-out, adjust steering box tie rod to align steering wheel if needed. Loosen tie rod lock nuts and turn steering box tie rod clockwise or counter clockwise to adjust steering wheel.

IMPORTANT: Ensure that after this adjustment, both wheels toe out from the cart's centerline equally.

To adjust camber (the vertical tilt of the wheels) to 90 degrees using the two nuts on the bottom heim joint (B).

If adjusting the camber to 90 degrees is not possible using only the adjustment on the bottom heim joint, then the top heim joint must be disconnected from the spindle and rotated as necessary to achieve the correct camber.

IMPORTANT: Be sure to retighten all adjustment points after adjustments are made.

Once tightened, roll the cart back 5-6 feet and then forward again to check.

INSTALLATION COMPLETE

VISIT WWW.MYMAJAX.COM FOR MORE INSTALLATION VIDEOS

Club Car®, Club Car® Precedent®, and Club Car® DS® are registered trademarks of Ingersoll Rand, Inc. ("Ingersoll Rand"). Reference to Club Car®, Club Car® Precedent®, or Club Car® DS® or any of Ingersoll Rand's trademarks, word marks, or products is only for purposes of identifying golf carts with which this Madjax product is compatible. Madjax products are aftermarket parts and are not original equipment parts. Madjax is not connected to, affiliated with, sponsored by, or endorsed by Ingersoll Rand or any of its subsidiary companies.