

This manual includes information on:

- Control Panel Use
- Application Macros
- Parameters
- Fault Tracing
- Fieldbus Control
- PFC Application Example

## Pump and Fan Control (PFC) Application Program 6.x





Pump and Fan Control (PFC)  
Application Program 6.x

**Firmware Manual**

3AFY 61279008 R0325  
EN  
EFFECTIVE: 1.1.2001



# Safety Instructions

---

## Overview

This chapter states the safety instructions which must be followed when installing, operating and servicing the ACS 600. If neglected, physical injury and death may follow, or damage may occur to the frequency converter, the motor and driven equipment. The material in this chapter must be studied before attempting any work on, or with, the unit.

## Warnings and Notes

This manual distinguishes two sorts of safety instructions. Warnings are used to inform of conditions which can, if proper steps are not taken, lead to a serious fault condition, physical injury and death. Notes are used when the reader is required to pay special attention or when there is additional information available on the subject. Notes are less critical than Warnings, but should not be disregarded.

### Warnings

Readers are informed of situations that can result in serious physical injury and/or serious damage to equipment with the following symbols:



**Dangerous Voltage Warning:** warns of situations in which a high voltage can cause physical injury and/or damage equipment. The text next to this symbol describes ways to avoid the danger.



**General Warning:** warns of situations which can cause physical injury and/or damage equipment by means other than electrical. The text next to this symbol describes ways to avoid the danger.



**Electrostatic Discharge Warning:** warns of situations in which an electrostatic discharge can damage equipment. The text next to this symbol describes ways to avoid the danger.

### Notes

Readers are notified of the need for special attention or additional information available on the subject with the following symbols:

#### CAUTION!

**Caution** aims to draw special attention to a particular issue.

#### Note:

**Note** gives additional information or points out more information available on the subject.

## General Safety Instructions

These safety instructions are intended for all work on the ACS 600. In addition to the instructions given below, there are more safety instructions on the first pages of the appropriate *Hardware Manual*.

---



**WARNING!** All electrical installation and maintenance work on the ACS 600 should be carried out by qualified electricians.

The ACS 600 and adjoining equipment must be properly earthed.

Do not attempt any work on a powered ACS 600. After switching off the mains, always allow the intermediate circuit capacitors 5 minutes to discharge before working on the frequency converter, the motor or the motor cable. It is good practice to check (with a voltage indicating instrument) that the frequency converter is in fact discharged before beginning work.

The ACS 600 motor cable terminals are at a dangerously high voltage when mains power is applied, regardless of motor operation.

There can be dangerous voltages inside the ACS 600 from external control circuits when the ACS 600 mains power is shut off. Exercise appropriate care when working with the unit. Neglecting these instructions can cause physical injury and death.

---



**WARNING!** The ACS 600 introduces electric motors, drive train mechanisms and driven machines to an extended operating range. It should be determined from the outset that all equipment is up to these conditions.

Operation is not allowed if the motor nominal voltage is less than one half of the ACS 600 nominal input voltage, or the motor nominal current is less than 1/6 of the ACS 600 nominal output current. Proper attention should be given to the motor insulation properties. The ACS 600 output comprises of short, high voltage pulses (approximately 1.35 ... 1.41 · mains voltage) regardless of output frequency. This voltage can be almost doubled by unfavourable motor cable properties. Contact an ABB office for additional information if multimotor operation is required. Neglecting these instructions can result in permanent damage to the motor.

All insulation tests must be carried out with the ACS 600 disconnected from the cabling. Operation outside the rated capacities should not be attempted. Neglecting these instructions can result in permanent damage to the ACS 600.

There are several automatic reset functions in the ACS 600. If selected, they reset the unit and resume operation after a fault. These functions should not be selected if other equipment is not compatible with this kind of operation, or dangerous situations can be caused by such action.

---

# Table of Contents

---

## **Safety Instructions**

## **Table of Contents**

### **Chapter 1 – Introduction to This Manual**

Overview . . . . .	1-1
Before You Start . . . . .	1-1
What This Manual Contains . . . . .	1-1
Related Publications . . . . .	1-2

### **Chapter 2 – Overview of ACS 600 Programming and the CDP 312 Control Panel**

Overview . . . . .	2-1
ACS 600 Programming . . . . .	2-1
Application Macros . . . . .	2-1
Parameter Groups . . . . .	2-1
Control Panel . . . . .	2-1
Panel Operation . . . . .	2-4
Keypad Modes . . . . .	2-4
Identification Display . . . . .	2-4
Actual Signal Display Mode . . . . .	2-4
Parameter Mode . . . . .	2-8
Function Mode . . . . .	2-9
Drive Selection Mode . . . . .	2-12
Operational Commands . . . . .	2-13

### **Chapter 3 – Start-up Data**

Overview . . . . .	3-1
Start-up Procedure . . . . .	3-1
Start-up Data Parameters . . . . .	3-7
ID Run Procedure . . . . .	3-11

### **Chapter 4 – Control Operation**

Overview . . . . .	4-1
Actual Signals . . . . .	4-1
Group 1 ACTUAL SIGNALS . . . . .	4-1
Group 2 ACTUAL SIGNALS . . . . .	4-3
Group 3 ACTUAL SIGNALS . . . . .	4-3
Fault History . . . . .	4-4
Local Control vs. External Control . . . . .	4-4
Local Control . . . . .	4-5
External Control . . . . .	4-5

**Chapter 5 – Application Macros**

Overview .....	5-1
Application Macros .....	5-1
Pump and Fan Control (PFC) Macro .....	5-2
Operation Diagram .....	5-3
External Connections .....	5-4
Control Signal Connections .....	5-5
Hand/Auto Application Macro .....	5-6
Operation Diagram .....	5-6
External Connections .....	5-7
Control Signal Connections .....	5-8
User Macros .....	5-9

**Chapter 6 – Parameters**

Overview .....	6-1
Parameter Groups .....	6-1
Group 10 START/STOP/DIR .....	6-2
Group 11 REFERENCE SELECT .....	6-5
Group 12 CONSTANT FREQ .....	6-9
Group 13 ANALOGUE INPUTS .....	6-10
Group 14 RELAY OUTPUTS .....	6-14
Group 15 ANALOGUE OUTPUTS .....	6-19
Group 16 SYSTEM CTR INPUTS .....	6-22
Group 20 LIMITS .....	6-25
Group 21 START/STOP .....	6-27
Group 22 ACCEL/DECEL .....	6-29
Group 23 SPEED CTRL .....	6-32
Group 25 CRITICAL FREQ .....	6-35
Group 26 MOTOR CONTROL .....	6-37
Group 30 FAULT FUNCTIONS .....	6-39
Group 31 AUTOMATIC RESET .....	6-49
Group 32 SUPERVISION .....	6-51
Group 33 INFORMATION .....	6-54
Group 51 COMM MOD DATA .....	6-55
Group 52 STANDARD MODBUS .....	6-55
Group 70 DDCS CONTROL .....	6-56
Group 80 PI CONTROL .....	6-57
Group 81 PFC CONTROL .....	6-62
Group 82 PRESSURE CONTROL .....	6-77
Group 90 D SET REC ADDR .....	6-81
Group 92 D SET TR ADDR .....	6-81
Group 98 OPTION MODULES .....	6-82

**Chapter 7 – Fault Tracing**

Fault Tracing .....	7-1
Fault Resetting .....	7-1
Fault History .....	7-2
Fault and Warning Messages .....	7-3



**Appendix A – Complete Parameter Settings**

**Appendix B – PFC Application Example**

Overview ..... B-1

**Appendix C – Fieldbus Control**

Overview ..... C-1

Control via NDCO Board Channel CH0 ..... C-2

    Fieldbus Adapter Communication Set-up ..... C-2

    AF 100 Connection ..... C-3

Control through the Standard Modbus Link ..... C-5

    Communication Set-up ..... C-5

Drive Control Parameters ..... C-6

The Fieldbus Control Interface ..... C-9

    The Control Word and the Status Word ..... C-9

    References ..... C-9

    Actual Values ..... C-10

    Modbus Addressing ..... C-10

Communication Profiles ..... C-13

**Index**

*Table of Contents*

# Chapter 1 – Introduction to This Manual

---

## **Overview**

This chapter describes the purpose, contents and the intended audience of this manual. It also lists related publications.

This Manual is compatible with the Pump and Fan Application Program version 6.0 or later.

## **Before You Start**

The purpose of this manual is to provide you with the information necessary to control and program your ACS 600 drive.

The audience for this manual is expected to have:

- Knowledge of standard electrical wiring practices, electronic components, and electrical schematic symbols.
- Minimal knowledge of ABB product names and terminology.
- No experience or training in installing, operating, or servicing the ACS 600.

## **What This Manual Contains**

*Safety Instructions* can be found on pages i - ii of this manual. The Safety Instructions describe the formats for various warnings and notations used in this manual. This chapter also states the general safety instructions which must be followed.

[Chapter 1 – Introduction to This Manual](#), the chapter you are reading now, introduces you to the *ACS 600 Firmware Manual*.

[Chapter 2 – Overview of ACS 600 Programming and the CDP 312 Control Panel](#) provides an overview of programming your ACS 600. This chapter describes the operation of the Control Panel used for controlling and programming.

[Chapter 3 – Start-up Data](#) lists and explains the Start-up Data parameters and describes the ID Run procedure.

[Chapter 4 – Control Operation](#) describes actual signals and keypad and external controls.

[Chapter 5 – Application Macros](#) describes the operation of the PFC Macro, the Hand/Auto Macro and the User Macro.

[Chapter 6 – Parameters](#) lists the ACS 600 parameters and explains the functions of each parameter.

[Chapter 7 – Fault Tracing](#) lists the ACS 600 fault and warning messages, possible causes and remedies.

[Appendix A – Complete Parameter Settings](#) lists, in tabular form, all parameter settings for the ACS 600 with PFC application Program.

[Appendix B – PFC Application Example](#) presents briefly an existing two-pump PFC application.

[Appendix C – Fieldbus Control](#) contains the information needed to control the ACS 600 through a fieldbus adapter module. There are several fieldbus adapter modules for the ACS 600 available as optional equipment.

*Index* helps you locate the page numbers of topics contained in this manual.

### **Related Publications**

In addition to this manual the ACS 600 user documentation includes the following manuals:

- Hardware manuals
- Several Installation and Start-up Guides for the optional devices for the ACS 600

## Chapter 2 – Overview of ACS 600 Programming and the CDP 312 Control Panel

---

### **Overview**

This chapter describes how to use the panel with ACS 600 to modify parameters, monitor actual values and control the drive.

---

**Note:** The CDP 312 Panel does not communicate with ACS 600 application program versions 3.x or earlier. The CDP 311 Panel does not communicate with program version 5.x or later.

---

### **ACS 600 Programming**

The user can change the configuration of the ACS 600 to meet the needs of the application by programming. The ACS 600 is programmable through a set of parameters.

#### **Application Macros**

Parameters can be set one by one or a preprogrammed set of parameters can be selected. Preprogrammed parameter sets are called Application Macros. See [Chapter 5 – Application Macros](#) for further information on the Application Macros.

#### **Parameter Groups**

In order to simplify programming, parameters in the ACS 600 are organised in Groups. Parameters of the Start-Up Data Group are described in [Chapter 3 – Start-up Data](#) and other parameters in [Chapter 6 – Parameters](#).

#### **Start-up Data Parameters**

The Start-up Data Group contains the basic settings needed to match the ACS 600 with your motor and to set the Control Panel display language. This group also contains a list of preprogrammed Application Macros. The Start-up Data Group includes parameters that are set at start-up, and should not need to be changed later on. See [Chapter 3 – Start-up Data](#) for description of each parameter.

### **Control Panel**

The Control Panel is the device used for controlling and programming the ACS 600. The Panel can be attached directly to the door of the cabinet or it can be mounted, for example, in a control desk.

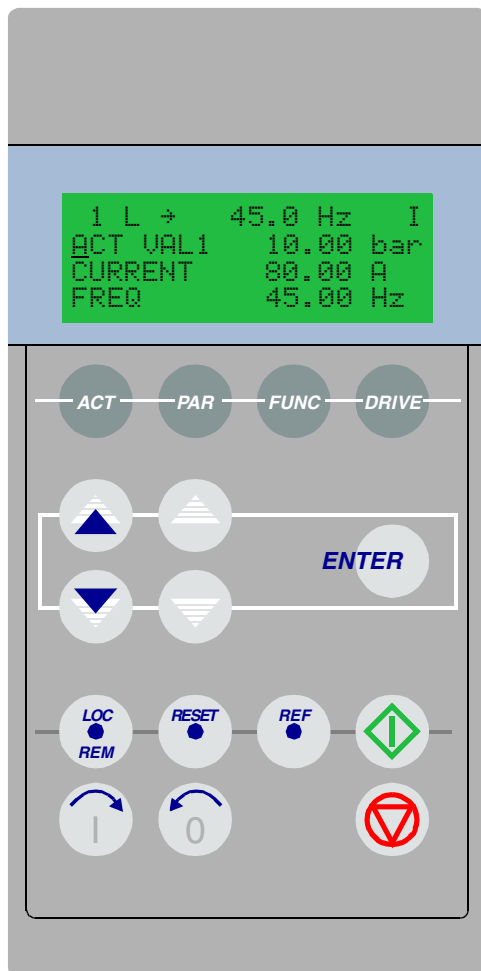

Figure 2-1 The Control Panel.

**Display** The LCD type display has 4 lines of 20 characters.

The language selection is made at start-up with Parameter [99.01 LANGUAGE](#). Depending on customer selection, a set of four languages is loaded into the memory of the ACS 600 at the factory (see [Chapter 3 – Start-up Data](#)).

**Keys** The keys on the Control Panel are flat, labelled push-buttons. Their functions are explained on the next page.

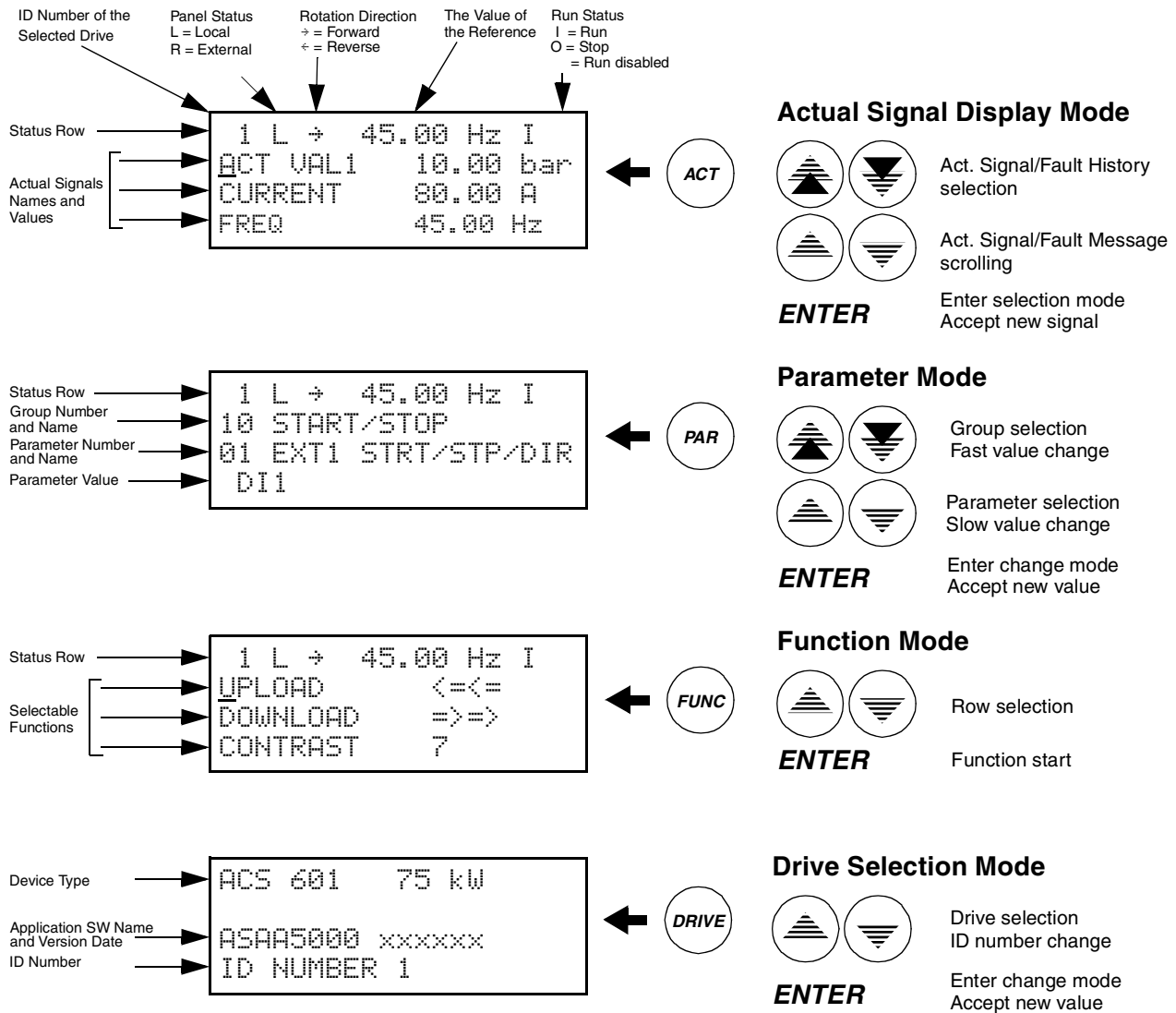

Figure 2-2 Control Panel Display indications and function of the Control Panel keys.

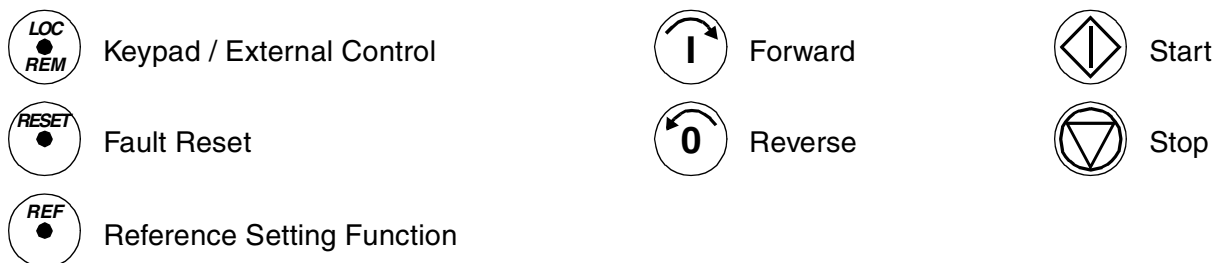

Figure 2-3 Operational commands of the Control Panel keys.

## Panel Operation

The following is a description of the operation of the Control Panel. The Control Panel Keys and Displays are explained in [Figure 2-1](#), [Figure 2-2](#), and [Figure 2-3](#).

### Keypad Modes

The Control Panel has four different keypad modes: Actual Signal Display Mode, Parameter Mode, Function Mode, and Drive Selection Mode. In addition to these, there is a special Identification Display, which is displayed after connecting the panel to the link. The Identification Display and the keypad modes are described briefly below.

### Identification Display

When the panel is connected for the first time, or the power is applied to the drive, the Identification Display appears.

---

**Note:** The panel can be connected to the drive while power is applied to the drive.

---

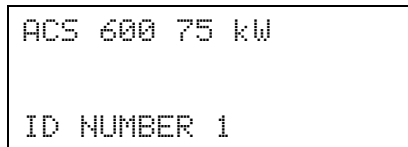

```
ACS 600 75 kW
ID NUMBER 1
```

After two seconds, the display will clear, and the Actual Signals of the drive will appear.

### Actual Signal Display Mode

This mode includes two displays, the Actual Signal Display and the Fault History Display. The Actual Signal Display is displayed first when the Actual Signal Display mode is entered. If the drive is in a fault condition, the Fault Display will be shown first.

The panel will automatically return to the Actual Signal Display Mode from other modes if no keys are pressed within one minute (exceptions: Status Display in Drive Selection Mode and Fault Display Mode).

In the Actual Signal Display Mode you can monitor three Actual Signals at a time. For more information of actual signals see [Chapter 4 – Control Operation](#). How to select the three Actual Signals to the display is explained in [Table 2-2](#).

The Fault History includes information on 64 faults and warnings that occurred in your ACS 600. 16 remains in the memory over a power switch-off. The procedure for clearing the Fault History is described in [Table 2-3](#).

The table below shows the events that are stored in the Fault History. For each event it is described what information is included.



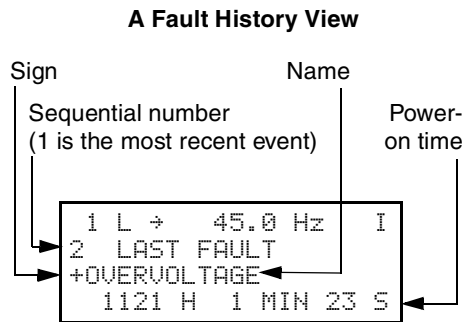

Event	Information
A fault is detected by ACS 600.	Sequential number of the event. Name of the fault and a "+" sign in front of the name. Total power on time.
A fault is reset by user.	Sequential number of the event. -RESET FAULT text. Total power on time.
A warning is activated by ACS 600.	Sequential number of the event. Name of the warning and a "+" sign in front of the name. Total power on time.
A warning is deactivated by ACS 600.	Sequential number of the event. Name of the warning and a "-" sign in front of the name. Total power on time.

When a fault or warning occurs in the drive, the message will be displayed immediately, except in the Drive Selection Mode. [Table 2-4](#) shows how to reset a fault. From the fault display, it is possible to change to other displays without resetting the fault. If no keys are pressed the fault or warning text is displayed as long as the fault exists.

See [Chapter 7 – Fault Tracing](#) for information on fault tracing.

Table 2-1 How to display the full name of the three Actual Signals.



Step	Function	Press key	Display
1.	To display the full name of the three actual signals.	<b>Hold</b> 	
2.	To return to the Actual Signal Display Mode.	<b>Release</b> 	

Table 2-2 How to select the Actual Signals to be displayed.





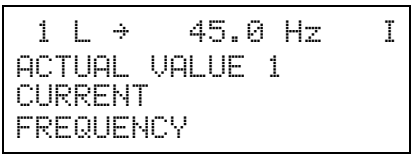

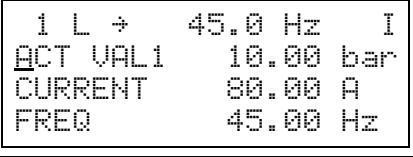



Step	Function	Press key	Display
1.	To enter the Actual Signal Display Mode.		<pre> 1 L ÷ 45.0 Hz I ACT VAL1 10.00 bar CURRENT 80.00 A FREQ 45.00 Hz                     </pre>
2.	To select a row (a blinking cursor indicates the selected row).	 	<pre> 1 L ÷ 45.0 Hz I ACT VAL1 10.00 bar CURRENT 80.00 A FREQ 45.00 Hz                     </pre>
3.	To enter the Actual Signal Selection Function.	<b>ENTER</b>	<pre> 1 L ÷ 45.0 Hz I 1 ACTUAL SIGNALS 03 CURRENT 80.00 A                     </pre>
4.	To select an actual signal.  To change the actual signal group.	    	<pre> 1 L ÷ 45.0 Hz I 1 ACTUAL SIGNALS 04 TORQUE 70.00 %                     </pre>
5.a	To accept the selection and to return to the Actual Signal Display Mode.	<b>ENTER</b>	<pre> 1 L ÷ 45.0 Hz I ACT VAL1 10.00 bar TORQUE 70.00 % FREQ 45.00 Hz                     </pre>
5.b	To cancel the selection and keep the original selection, press any of the Mode keys  The selected Keypad Mode is entered.	    	<pre> 1 L ÷ 45.0 Hz I ACT VAL1 10.00 bar CURRENT 80.00 A FREQ 45.00 Hz                     </pre>

Table 2-3 How to display a fault and reset the Fault History. The fault history cannot be reset if there is a fault or warning active.











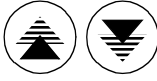
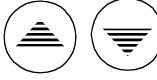







Step	Function	Press key	Display
1.	To enter the Actual Signal Display Mode.		<pre> 1 L ÷ 45.0 Hz I ACT VAL1 10.00 bar CURRENT 80.00 A FREQ 45.00 Hz                     </pre>
2.	To enter the Fault History Display.		<pre> 1 L ÷ 45.0 Hz I 1 LAST FAULT +OVERCURRENT 6451 H 21 MIN 23 S                     </pre>
3.	To select the previous (UP) or the next fault/warning (DOWN).		<pre> 1 L ÷ 45.0 Hz I 2 LAST FAULT +OVERVOLTAGE 1121 H 1 MIN 23 S                     </pre>
	To clear the Fault History.		<pre> 1 L ÷ 45.0 Hz I 2 LAST FAULT                     </pre>
	The Fault History is empty.		<pre> H MIN S                     </pre>
4.	To return to the Actual Signal Display Mode.		<pre> 1 L ÷ 45.0 Hz I ACT VAL1 10.00 bar CURRENT 80.00 A FREQ 45.00 Hz                     </pre>

Table 2-4 How to display and reset an active fault.

Step	Function	Press Key	Display
1.	To display an active fault.		<pre> 1 L ÷ 45.0 Hz ACS 601 75 kW ** FAULT ** ACS 600 TEMP                     </pre>
2.	To reset the fault.		<pre> 1 L ÷ 45.0 Hz 0 ACT VAL1 10.00 bar CURRENT 80.00 A FREQ 45.00 Hz                     </pre>

**Parameter Mode** The Parameter Mode is used for changing the ACS 600 parameters. When this mode is entered for the first time after power up, the display will show the first parameter of the first group. The next time the Parameter Mode is entered, the previously selected parameter is shown.

Table 2-5 How to select a parameter and change the value.

Step	Function	Press key	Display
1.	To enter the Parameter Mode.		<pre> 1 L ÷ 45.0 Hz 0 10 START/STOP/DIR 01 EXT1 STRT/STP/DIR DI1                     </pre>
2.	To select a different group.	 	<pre> 1 L ÷ 45.0 Hz 0 11 REFERENCE SELECT 01 KEYPAD REF SEL REF1 (Hz)                     </pre>
3.	To select a parameter.	 	<pre> 1 L ÷ 45.0 Hz 0 11 REFERENCE SELECT 03 EXT REF1 SELECT AI1                     </pre>
4.	To enter the Parameter Setting function.	<b>ENTER</b>	<pre> 1 L ÷ 45.0 Hz 0 11 REFERENCE SELECT 03 EXT REF1 SELECT [AI1]                     </pre>
5.	To change the parameter value. (slow change for numbers and text)  (fast change for numbers only)	   	<pre> 1 L ÷ 45.0 Hz 0 11 REFERENCE SELECT 03 EXT REF1 SELECT [AI2]                     </pre>
6a.	To save the new value.	<b>ENTER</b>	<pre> 1 L ÷ 45.0 Hz 0 11 REFERENCE SELECT 03 EXT REF1 SELECT AI2                     </pre>
6b.	To cancel the new setting and keep the original value, press any of the Mode keys. The selected Keypad Mode is entered.	   	<pre> 1 L ÷ 45.0 Hz 0 11 REFERENCE SELECT 03 EXT REF1 SELECT AI1                     </pre>

**Function Mode**

The Function Mode is used to select special functions. These functions include Parameter Upload, Parameter Download and setting the contrast of the Control Panel display.

Parameter Upload will copy all parameters and the results of motor identification from the drive to the panel. The upload function can be performed while the drive is running. Only the STOP command can be given during the uploading process.

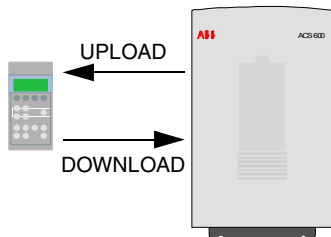

Table 2-6 and subsection *Copying Parameters from One Unit to Other Units* below describe how to select and perform Parameter Upload and Parameter Download functions.









**Note:**

- By default, Parameter Download will copy parameter Groups 10 to 97 stored in the panel to the drive. Groups 98 and 99 concerning options, language, macro and motor data are not downloaded.
- Uploading has to be done before downloading.
- The parameters can be uploaded and downloaded only if the drive firmware versions (see Parameters [33.01 SOFTWARE VERSION](#) and [33.02 APPL SW VERSION](#)) of the destination drive are the same as the versions of the source drive.
- The drive must be stopped during the downloading process.

Table 2-6 How to select and perform a function.



Step	Function	Press Key	Display
1.	To enter the Function Mode.		<pre> 1 L → 45.0 Hz 0 UPLOAD  &lt;=&lt;= DOWNLOAD =&gt;=&gt; CONTRAST 4                     </pre>
2.	To select a function (a flashing cursor indicates the selected function).		<pre> 1 L → 45.0 Hz 0 UPLOAD  &lt;=&lt;= <u>DOWN</u>LOAD =&gt;=&gt; CONTRAST 4                     </pre>
3.	To start the selected function.	<b>ENTER</b>	<pre> 1 L → 45.0 Hz 0 =&gt;=&gt;=&gt;=&gt;=&gt;=&gt;=&gt; DOWNLOAD                     </pre>

Table 2-7 How to set the contrast of the panel display.

Step	Function	Press Key	Display
1.	To enter the Function Mode.		<pre> 1 L ÷ 45.0 Hz 0 _UPLOAD &lt;=&lt;= _DOWNLOAD =&gt;=&gt; _CONTRAST 4                     </pre>
2.	To select a function (a flashing cursor indicates the selected function).	 	<pre> 1 L ÷ 45.0 Hz 0 _UPLOAD &lt;=&lt;= _DOWNLOAD =&gt;=&gt; <u>_CONTRAST</u> 4                     </pre>
3.	To enter the contrast setting function.	<b>ENTER</b>	<pre> 1 L ÷ 45.0 Hz 0 CONTRAST [4]                     </pre>
4.	To adjust the contrast.	 	<pre> 1 L ÷ 45.0 Hz 0 CONTRAST [6]                     </pre>
5.a	To accept the selected value.	<b>ENTER</b>	<pre> 1 L ÷ 45.0 Hz 0 _UPLOAD &lt;=&lt;= _DOWNLOAD =&gt;=&gt; <u>_CONTRAST</u> 6                     </pre>
5.b	To cancel the new setting and retain the original value, press any of the Mode keys.  The selected Keypad Mode is entered.	   	<pre> 1 L ÷ 45.0 Hz 0 _UPLOAD &lt;=&lt;= _DOWNLOAD =&gt;=&gt; <u>_CONTRAST</u> 4                     </pre>

*Copying Parameters from One Unit to Other Units*

You can copy parameters from one drive to another by using the Parameter Upload and Parameter Download functions in the Function Mode. Follow the procedure below:

1. Select the correct options (Group 98), language and macro (Group 99) for each drive.
2. Set the rating plate values for the motors (Group 99), and perform the identification for each motor (the Identification Magnetisation at zero speed by pressing start, or an ID Run. For the ID Run procedure see [Chapter 3 – Start-up Data](#)).
3. Set the parameters in Groups 10 to 97 as preferred in one ACS 600 drive.
4. Upload the parameters from the ACS 600 to the panel (see [Table 2-6](#)).
5. Press the  key to change to external control (no L visible on the first row of the display).
6. Disconnect the panel and reconnect it to the next ACS 600 unit.
7. Ensure the target ACS 600 is in Local control (L shown on the first row of the display). If necessary, change by pressing .
8. Download the parameters from the panel to the ACS 600 unit (see [Table 2-6](#)).
9. Repeat steps 7. and 8. for the rest of the units.

---

**Note:** Parameters in Groups 98 and 99 concerning options, language, macro and motor data are not downloaded.<sup>1)</sup>

---









<sup>1)</sup> The restriction prevents downloading of incorrect motor data (Group 99). In special cases it is also possible to download Groups 98 and 99 and the results of the motor identification. For more information, please contact your local ABB representative.

**Drive Selection Mode** In normal use the features available in the Drive Selection Mode are not needed; these features are reserved for applications where several drives are connected to one Panel Link. (For more information, see the *NBCI-0x Bus Connection Interface Module Installation and Start-up Guide* (3AFY 58919748 [English]).

Panel Link is the communication link connecting the Control Panel and the ACS 600. Each on-line station must have an individual identification number (ID). By default, the ID number of the ACS 600 is 1.

**CAUTION!** The default ID number setting of the ACS 600 should not be changed unless it is to be connected to the Panel Link with other drives on-line.

Table 2-8 How to select a drive and change its ID number.

Step	Function	Press key	Display
1.	To enter the Drive Selection Mode.		<div style="border: 1px solid black; padding: 5px;"> <pre>ACS 600    75 kW ASAA6000  xxxxxxx ID NUMBER  1</pre> </div>
2.	<p>To select the next view.</p> <p>The ID number of the station is changed by first pressing <b>ENTER</b> (the brackets round the ID number appear) and then adjusting the value with   buttons. The new value is accepted with <b>ENTER</b>.</p> <p>The power of the ACS 600 must be switched off to validate its new ID number setting (the new value is not displayed until the power is switched off and on).</p> <p>The Status Display of all devices connected to the Panel Link is shown after the last individual station. If all stations do not fit on the display at once, press  to view the rest of them.</p>		<div style="border: 1px solid black; padding: 5px;"> <pre>ACS 600    75 kW ASAA6000  xxxxxxx ID NUMBER  1</pre> </div> <div style="border: 1px solid black; padding: 5px; margin-top: 10px;"> <pre>1<sup>‡</sup></pre> </div> <p>Status Display Symbols:  <sup>‡</sup> = Drive stopped, direction forward  <sup>†</sup> = Drive running, direction reverse  F = Drive has tripped on a fault</p>
3.	<p>To connect to the last displayed drive and to enter another mode, press one of the Mode keys.</p> <p>The selected Keypad Mode is entered.</p>	  	<div style="border: 1px solid black; padding: 5px;"> <pre>1 L †    45.0 Hz    I ACT VAL1  10.00 bar CURRENT   80.00 A FREQ      45.00 Hz</pre> </div>



**Operational Commands**

Operational commands include starting and stopping the drive, changing the direction of rotation and adjusting the reference. The reference value is used for controlling motor frequency or process value.

*Changing Control Location*

Operational commands can be given from the Control Panel always when the status row is displayed and the control location is the panel. This is indicated by L (Local Control) on the display. R (Remote Control) indicates that External control is active and the Panel is the signal source for the external reference or the Start/Stop/Direction signals the ACS 600 is following.

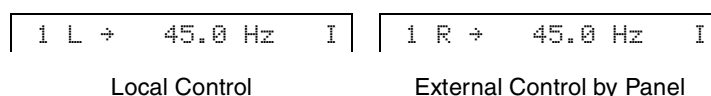

If there is neither an L nor an R on the first row of the display, the drive is controlled by another device. Operational commands cannot be given from this panel. Only monitoring actual signals, setting parameters, uploading and changing ID numbers is possible.



The control is changed between Local and External control locations by pressing the **LOC REM** key. See [Chapter 4 – Control Operation](#) for the explanation of Local and External control.

*Start, Stop, Direction and Reference*

















Start, Stop and Direction commands are given from the panel by pressing , ,  or . [Table 2-9](#) explains how to set the Reference from the panel.

Table 2-9 How to set the reference.

Step	Function	Press Key	Display
1.	To enter a Keypad Mode displaying the status row, press a Mode key.	  	<pre> 1 L → 45.0 Hz I ACT VAL1 10.00 bar CURRENT 80.00 A FREQ 45.00 Hz                     </pre>
2.	To enter the Reference Setting function. A blinking cursor indicates that the Reference Setting function has been selected.		<pre> 1 L → [ 45.0 Hz ] I ACT VAL1 10.00 bar CURRENT 80.00 A FREQ 45.00 Hz                     </pre>
3.	To change the reference. (slow change)  (fast change)	   	<pre> 1 L → [ 48.0 Hz ] I ACT VAL1 10.00 bar CURRENT 81.00 A FREQ 48.00 Hz                     </pre>
4.a	To save the reference press Enter. The value is stored in the permanent memory. It is restored automatically after power switch-off.	<p><b>ENTER</b></p>	<pre> 1 L → 48.0 Hz I ACT VAL1 10.00 bar CURRENT 81.00 A FREQ 48.00 Hz                     </pre>
4.b	To escape the Reference Setting Mode, without saving the value in the permanent memory, press any of the Mode keys. The selected Keypad Mode is entered.	   	<pre> 1 L → 48.0 Hz I ACT VAL1 10.00 bar CURRENT 81.00 A FREQ 48.00 Hz                     </pre>

## Chapter 3 – Start-up Data

### Overview

The first part of this chapter is the Start-up Procedure of ACS 600 frequency converters.

The second part of the chapter lists and explains the Start-up Data Parameters. The Start-up Data Parameters are a special set of parameters that allow you to set up the ACS 600 and motor information. Start-up Data Parameters should only need to be set during start-up and should not need to be changed afterwards.

### Start-up Procedure

The table below is a step-by-step instruction for initialising the ACS 600 frequency converter into use. The procedure is common for several ACS 600 Application Programs, the Pump and Fan Control (PFC) Program among others. Since the procedure is generic and based on the Standard Application Program, display views of the Control Panel may not exactly match the views of the PFC Program.

**Note:** Before beginning the start-up of ACS 600 equipped with Pump and Fan Control (PFC) Program, ensure that all the interlock inputs are ON at the digital I/O terminals of the Standard I/O Board (NIOC).

### START-UP PROCEDURE

#### 1 – SAFETY











The start-up procedure must only be carried out by a qualified electrician.

The safety instructions must be followed during the start-up procedure. See the appropriate hardware manual for the safety instructions.

The ACx 600 must not be powered up more than five times in ten minutes to avoid charging resistor overheating. (This does not apply to ACS 600 MultiDrive and ACx 607 units -0760-3, -0930-5, -0900-6 or above).

- Check the installation before the start-up procedure. See the installation checklist from the appropriate hardware/installation manual.
- Check that starting the motor does not cause any danger.

It is recommended having the driven equipment disengaged when first start is performed if there is the risk of damage to the driven equipment in case of incorrect rotation direction of the motor.

<b><u>START-UP PROCEDURE</u></b>	
<b>2 – POWER-UP</b>	
<p><input type="checkbox"/> <b>Apply mains power.</b> The Control Panel first enters the panel identification data ...</p> <p>... then the Identification Display of the drive ...</p> <p>... and after a few seconds the Control Panel automatically enters the Actual Signal Display.</p> <p>Drive set-up can be started.</p>	<div style="border: 1px solid black; padding: 5px; margin-bottom: 10px;"> <pre>CDF312 PANEL   Ux.xx .....</pre> </div> <div style="border: 1px solid black; padding: 5px; margin-bottom: 10px;"> <pre>ACS 600       xx kW ID NUMBER 1</pre> </div> <div style="border: 1px solid black; padding: 5px;"> <pre>1   -&gt;   0.0 Hz   0 ACT VAL1   0.00 bar CURRENT    0.00 A FREQ       0.00 Hz</pre> </div>
<b>3 – ENTERING START-UP DATA (Parameter Group 99)</b>	
<p><input type="checkbox"/> <b>Select the language.</b> The general parameter setting procedure is given below.</p> <p>The general parameter setting procedure:</p> <ul style="list-style-type: none"> <li>• Press <b>PAR</b> to select parameter mode.</li> <li>• Press  or  to scroll Parameter Groups (10 to 99).</li> <li>• Press  or  to scroll parameters within the Parameter Group.</li> <li>• Select a new value by <b>ENTER</b> (brackets appear around the parameter value) and  or . (Fast change by  or .)</li> <li>• Press <b>ENTER</b> to accept the new value (brackets disappear).</li> </ul> <p><input type="checkbox"/> <b>Select the Application Macro.</b> The general parameter setting procedure is given above.</p> <p>The default value is suitable in most cases. See a detailed description of the Application Macros in <a href="#">Chapter 5 – Application Macros</a>.</p>	<div style="border: 1px solid black; padding: 5px; margin-bottom: 10px;"> <pre>1   -&gt;   0.0 Hz   0 99 START-UP DATA 01 LANGUAGE ENGLISH</pre> </div> <div style="border: 1px solid black; padding: 5px; margin-bottom: 10px;"> <pre>1   -&gt;   0.0 Hz   0 99 START-UP DATA 01 LANGUAGE [ENGLISH]</pre> </div> <div style="border: 1px solid black; padding: 5px;"> <pre>1   -&gt;   0.0 Hz   0 99 START-UP DATA 02 APPLICATION MACRO [ ]</pre> </div>

**START-UP PROCEDURE**

- ❑ **Select the motor control mode.** The general parameter setting procedure is given above.

DTC is suitable in most cases. The SCALAR control mode is recommended

- for multimotor drives when the number of motors connected to the ACS 600 is variable.
- when the nominal current of the motor is less than 1/6 of the nominal current of the inverter.
- when the inverter is used for test purposes with no motor connected.

**Enter the motor data from the motor nameplate.**

3 ~ motor M2AA 200 MLA 4							
IEC 200 M/L 55							
No							
Ins.cl. F						IP 55	
V	Hz	kW	r/min	A	cos φ	IA/IN	tE/s
690 Y	50	30	1475	32.5	0.83		
400 D	50	30	1475	56	0.83		
660 Y	50	30	1470	34	0.83		
380 D	50	30	1470	59	0.83		
415 D	50	30	1475	54	0.83		
440 D	60	35	1770	59	0.83		
Cat. no 3GAA 202 001 - ADA							
6312/C3		6210/C3		180 kg			
IEC 34-1							

**Note:** Set the motor data exactly the same as on the motor nameplate. For example, if the motor nominal speed is 1440 rpm on the nameplate, setting the value of Parameter **99.08 MOTOR NOM SPEED** to 1500 rpm results in wrong operation of the drive.

- ❑ **Nominal voltage.** The general parameter setting procedure is given on page 3-2.

Allowed range:  $1/2 \cdot U_N \dots 2 \cdot U_N$  of ACS 600. ( $U_N$  refers to the highest voltage in each of the nominal voltage ranges: 415 VAC for 400 VAC units, 500 VAC for 500 VAC units and 690 VAC for 600 VAC units.)

- ❑ **Nominal current.** The general parameter setting procedure is given on page 3-2.

Allowed range:  $1/6 \cdot I_{2hd} \dots 2 \cdot I_{2hd}$  of ACS 600

```

1   ->  0.0 Hz  0
99 START-UP DATA
04 MOTOR CTRL MODE
[ DTC ]
    
```

```

1   ->  0.0 Hz  0
99 START-UP DATA
05 MOTOR NOM VOLTAGE
[ ]
    
```

```

1   ->  0.0 Hz  0
99 START-UP DATA
06 MOTOR NOM CURRENT
[ ]
    
```

<b>START-UP PROCEDURE</b>		
<input type="checkbox"/> Nominal frequency. The general parameter setting procedure is given on page 3-2. Range: 8 ... 300 Hz	<pre> 1   -&gt;  0.0 Hz   0 99 START-UP DATA 07 MOTOR NOM FREQ [ ]                     </pre>	
<input type="checkbox"/> Nominal speed. The general parameter setting procedure is given on page 3-2. Range: 1 ... 18000 rpm	<pre> 1   -&gt;  0.0 Hz   0 99 START-UP DATA 08 MOTOR NOM SPEED [ ]                     </pre>	
<input type="checkbox"/> Nominal power. The general parameter setting procedure is given on page 3-2. Range: 0... 9000 kW	<pre> 1   -&gt;  0.0 Hz   0 99 START-UP DATA 09 MOTOR NOM POWER [ ]                     </pre>	
When the motor data has been entered a warning appears. It indicates that the motor parameters have been set, and the ACS 600 is ready to start the motor identification (ID magnetisation or ID Run).		<pre> 1   -&gt;  0.0 Hz   0  ** WARNING ** ID MAGN REQ                     </pre>
<input type="checkbox"/> Select the motor identification. The general parameter setting procedure is given on page 3-2. The default value NO is suitable for most applications. It is applied in this basic start-up procedure. The ID Run (STANDARD or REDUCED) should be selected instead if: <ul style="list-style-type: none"> <li>• Operation point is near zero speed.</li> <li>• Operation at torque range above the motor nominal torque within wide speed range and without any pulse encoder (i.e. without any measured speed feedback) is required.</li> </ul> See the second part of this chapter for the ID Run procedure.	<pre> 1   -&gt;  0.0 Hz   0 99 START-UP DATA 10 MOTOR ID RUN [NO]                     </pre>	
<b>4 – IDENTIFICATION MAGNETISATION</b> with Motor ID Run selection NO		
<input type="checkbox"/> Press the <b>LOC/REM</b> key to change to local control (L shown on the first row). Press the  to start the magnetisation. The motor is magnetised at zero speed for 20 to 60 s. Two warnings are displayed: <ul style="list-style-type: none"> <li>• The upper warning is displayed while the magnetisation is on.</li> <li>• The lower warning is displayed after the magnetisation is completed.</li> </ul>	<pre> 1  L-&gt;  0.0 Hz   I  ** WARNING ** ID MAGN                     </pre> <pre> 1  L-&gt;  0.0 Hz   0  ** WARNING ** ID DONE                     </pre>	

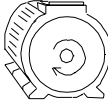
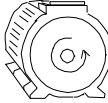
<b>START-UP PROCEDURE</b>		
<b>5 – ROTATION DIRECTION OF THE MOTOR</b>		
<p><input type="checkbox"/> Check the rotation direction of the motor.</p> <ul style="list-style-type: none"> <li>• Press <b>ACT</b> to make the status row visible.</li> <li>• Increase the speed reference from zero to a small value by pressing <b>REF</b> and then <math>\ominus</math> or <math>\omin�</math> (<math>\oplus</math> or <math>\opl�</math>).</li> <li>• Press <math>\odot</math> (Start) to start the motor.</li> <li>• Check that the motor is running in the desired direction.</li> <li>• Stop the motor by pressing <math>\odot</math>.</li> </ul> <p>To change the rotation direction of the motor:</p> <ul style="list-style-type: none"> <li>• Disconnect mains power from the ACx 600, and wait 5 minutes for the intermediate circuit capacitors to discharge. Measure the voltage between each input terminal (U1, V1 and W1) and earth with a multimeter to ensure that the frequency converter is discharged.</li> <li>• Exchange the position of two motor cable phase conductors at the motor terminals or at the motor connection box.</li> <li>• Verify your work by applying mains power and repeating the check as described above.</li> </ul>	<div style="border: 1px solid black; padding: 5px; margin-bottom: 10px;"> <pre> 1 L-&gt;[xxxx] Hz I ACT VAL1 0.00 bar CURRENT 0.00 A FREQ 0.00 Hz                     </pre> </div> <div style="display: flex; align-items: center; margin-bottom: 10px;">  <p>forward direction</p> </div> <div style="display: flex; align-items: center;">  <p>reverse direction</p> </div>	
<b>6 – SPEED LIMITS AND ACCELERATION/DECELERATION TIMES</b>		
<p><input type="checkbox"/> Set the minimum speed. The general parameter setting procedure is given on page 3-2.</p>	<div style="border: 1px solid black; padding: 5px;"> <pre> 1 L-&gt; 0.0 Hz 0 20 LIMITS 01 MINIMUM SPEED [ ]                     </pre> </div>	
<p><input type="checkbox"/> Set the maximum speed. The general parameter setting procedure is given on page 3-2.</p>	<div style="border: 1px solid black; padding: 5px;"> <pre> 1 L-&gt; 0.0 Hz 0 20 LIMITS 02 MAXIMUM SPEED [ ]                     </pre> </div>	
<p><input type="checkbox"/> Set acceleration time 1. The general parameter setting procedure is given on page 3-2.</p> <p><b>Note:</b> Also check acceleration time 2 in case two acceleration times will be used in the application.</p>	<div style="border: 1px solid black; padding: 5px;"> <pre> 1 L-&gt; 0.0 Hz 0 22 ACCEL/DECEL 02 ACCELER TIME 1 [ ]                     </pre> </div>	
<p><input type="checkbox"/> Set deceleration time 1. The general parameter setting procedure is given on page 3-2.</p> <p><b>Note:</b> Also set deceleration time 2 in case two deceleration times will be used in the application.</p>	<div style="border: 1px solid black; padding: 5px;"> <pre> 1 L-&gt; 0.0 Hz 0 22 ACCEL/DECEL 03 DECELER TIME 1 [ ]                     </pre> </div>	

<b><u>START-UP PROCEDURE</u></b>	
<b>7 – STARTING THE DRIVE THROUGH THE I/O INTERFACE</b>	
<p>By default, the external start/stop signal is read from the digital input DI6, and the external reference from the analogue input AI1.</p> <p>Starting through a digital input:</p> <ul style="list-style-type: none"> <li>• Press the <b>LOC/REM</b> key to change to external control (no L visible on the first row of the panel display).</li> <li>• Switch on digital input DI6.</li> </ul> <p>ACS 600 starts to regulate motor speed depending on the process reference (AI1) and actual value (AI2).</p>	<p>Valid if the PFC macro is selected. See Parameter <a href="#">99.02 APPLICATION MACRO</a>.</p>
<b>8 – STOPPING THE MOTOR</b>	
<p>Stopping when in local control: Press  .</p> <p>Stopping when in external control: Switch off digital input DI6.</p> <p>Press the <b>LOC/REM</b> key to change between local and external control.</p>	<p>Valid if the PFC macro is selected. See Parameter <a href="#">99.02 APPLICATION MACRO</a>.</p>



## Start-up Data Parameters

When changing the value of the Start-up Data Parameters, follow the procedure described in [Chapter 2 – Overview of ACS 600 Programming and the CDP 312 Control Panel](#), Table 2-5. Table 3-1 lists the Start-up Data Parameters. The Range/Unit column shows the alternative parameter values, explained in detail below the table.



**WARNING!** Running the motor and the driven equipment with incorrect start-up data can result in improper operation, reduction in control accuracy and damage to equipment.

Table 3-1 Group 99.

Parameter	Range/Unit	Description
99.01 LANGUAGE	Languages	Display language selection.
99.02 APPLICATION MACRO	Application Macros	Application Macro selection.
99.03 APPLIC RESTORE	NO; YES	Restores parameters to factory setting values.
99.04 MOTOR CTRL MODE	DTC; SCALAR	Motor control mode selection.
99.05 MOTOR NOM VOLTAGE	$1/2 \times U_N$ of ACS 600 ... $2 \times U_N$ of ACS 600	Nominal voltage from the motor rating plate.
99.06 MOTOR NOM CURRENT	$1/6 \times I_{2hd}$ of ACS 600 ... $2 \times I_{2hd}$ of ACS 600	Matches the ACS 600 to the rated motor current.
99.07 MOTOR NOM FREQ	8 ... 300 Hz	Nominal frequency from the motor rating plate.
99.08 MOTOR NOM SPEED	1 ... 18000 rpm	Nominal speed from the motor rating plate.
99.09 MOTOR NOM POWER	0 ... 9000 kW	Nominal power from the motor rating plate.
99.10 MOTOR ID RUN	NO; STANDARD; REDUCED	Selects the type of the motor identification run.

**Parameters 99.04 ... 99.09 are always to be set at start-up.**

**Note:** If the ACS 600 is used for controlling parallel-connected motors (this DOES NOT refer to alternation of two motors), some additional instructions must be considered when setting the Start-up Data Parameters. Please contact your local ABB representative for more information.

**99.01 LANGUAGE** The ACS 600 displays all information in the language you select. alternatives are:

- English; English (Am); French; Spanish; Portuguese; German; Italian; Dutch; Danish; Swedish; Finnish; Czech; Polish.

If English (Am) is selected, the unit of power used is HP instead of kW.

**99.02 APPLICATION MACRO** This parameter is used to select the Application Macro which will configure the ACS 600 for a particular application. Refer to [Chapter 5 – Application Macros](#) for a list and description of available Application Macros. There is also a selection for saving the current settings as a User Macro (USER 1 SAVE or USER 2 SAVE), and recalling these settings (USER 1 LOAD or USER 2 LOAD).

There are Parameters that are not included in Macros. See section [99.03 APPLIC RESTORE](#).

---

**Note:** User Macro load restores also the motor settings of the Start-up Data group and the results of the Motor Identification. Check that the settings correspond to the motor used.

---

**99.03 APPLIC RESTORE** Selection YES restores the original settings of an application macro as follows:

- If the PFC or Hand/Auto Macro is selected, the parameter values excluding Groups 98 and 99 are restored to the settings loaded at the factory.
- If User Macro 1 or 2 is in use, the parameter values are restored to the last saved values. In addition, the last saved results of the motor identification are restored (see [Chapter 5 – Application Macros](#)). Exceptions: Settings of Parameters [16.05 USER MACRO IO CHG](#) and [99.02 APPLICATION MACRO](#) remain unchanged.

---

**Note:** The parameter settings and the results of motor identification are restored according to the same principles when a macro is changed to another.

---

**99.04 MOTOR CTRL  
MODE**

This parameter sets the motor control mode.

**DTC**

The DTC (Direct Torque Control) mode is suitable for most applications. The ACS 600 performs precise speed and torque control of standard squirrel cage motors without pulse encoder feedback.

If several motors are connected in parallel to the ACS 600, there are certain restrictions on the usage of DTC. Please contact your local ABB representative for more information.

**SCALAR**

The scalar control should be selected in those special cases in which the DTC cannot be applied. The SCALAR control mode is recommended for multimotor drives when the number of motors connected to the ACS 600 is variable. The SCALAR control is also recommended when the nominal current of the motor is less than 1/6 of the nominal current of the inverter or the inverter is used for test purposes with no motor connected.

The outstanding motor control accuracy of DTC cannot be achieved in the scalar control mode. The differences between the SCALAR and DTC control modes are discussed further in this manual in relevant parameter lists.

There are some standard features that are disabled in the SCALAR control mode: Motor Identification Run (Group 99), Frequency Limits (Group 20), Torque Limit (Group 20), DC Magnetizing (Group 21), Speed Controller Tuning (Group 23), Flux Optimization (Group 26), Flux Braking (Group 26), Underload Function (Group 30), Motor Phase Loss Protection (Group 30), Motor Stall Protection (Group 30). Furthermore, a rotating motor cannot be started or fast motor restart performed even it is possible to select the automatic start function ([21.01 START FUNCTION](#)).

**99.05 MOTOR NOM  
VOLTAGE**

This parameter matches the ACS 600 with the nominal voltage of the motor as indicated on the motor rating plate.

---

**Note:** It is not allowed to connect a motor with nominal voltage less than  $1/2 \times U_N$  or more than  $2 \times U_N$  of the ACS 600.

---

**99.06 MOTOR NOM  
CURRENT**

This parameter matches the ACS 600 to the rated motor current. The allowed range  $1/6 \times I_{2hd} \dots 2 \times I_{2hd}$  of ACS 600 is valid for DTC motor control mode. In SCALAR mode the allowed range is  $0 \times I_{2hd} \dots 2 \times I_{2hd}$  of ACS 600.

Correct motor run requires that the magnetizing current of the motor does not exceed 90 per cent of the nominal current of the inverter.

**99.07 MOTOR NOM  
FREQ**

This parameter matches the ACS 600 to the rated motor frequency, adjustable from 8 Hz to 300 Hz.

**99.08 MOTOR NOM  
SPEED**

This parameter matches the ACS 600 to the nominal speed as indicated on the motor rating plate.

---

**Note:** It is very important to set this parameter exactly to the value given on the motor rating plate to guarantee proper operation of the drive. The motor synchronous speed or another approximate value must not be given instead!

---



**Note:** The speed limits in [Group 20 LIMITS](#) are linked to the setting of [99.08 MOTOR NOM SPEED](#). If value of Parameter [99.08 MOTOR NOM SPEED](#) is changed, the speed limit settings change automatically as well.

---

**99.09 MOTOR NOM  
POWER**

This parameter matches the ACS 600 to the rated power of the motor, adjustable between 0 kW and 9000 kW.

**99.10 MOTOR ID RUN**

This parameter is used to initiate the Motor Identification Run. During the run, the ACS 600 will identify the characteristics of the motor for optimum motor control. The ID Run takes about one minute.

The ID run cannot be performed if the scalar control mode is selected (Parameter [99.04 MOTOR CTRL MODE](#) is set to SCALAR).

**NO**

The Motor ID Run is not performed. This can be selected in most applications. The motor model is calculated at first start by magnetising the motor for 20 to 60 s at zero speed.

---

**Note:** The ID Run (Standard or Reduced) should be selected if:

- operation point is near zero speed
  - operation at torque range above the motor nominal torque within wide speed range and without any pulse encoder (i.e. without any measured speed feedback) is required.
- 

**STANDARD**

Performing the Standard Motor ID Run guarantees that the best possible control accuracy is achieved. The motor must be de-coupled from the driven equipment before performing the Standard Motor ID Run.

**REDUCED**

The Reduced Motor ID Run should be selected instead of the Standard ID Run:

- if mechanical losses are higher than 20% (i.e. the motor cannot be de-coupled from the driven equipment)
- if flux reduction is not allowed while the motor is running (i.e. in case of a braking motor in which the brake switches on if the flux is reduced below a certain level).

---

**Note:** Check the rotation direction of the motor before starting the Motor ID Run. During the run the motor will rotate in the forward direction.

---

**Note:** If the Pump and Fan Control Macro is selected (parameter [99.02 APPLICATION MACRO](#)) and the Interlocks are taken in use (Parameter [81.20 INTERLOCKS](#) is set to ON), the interlock signal of motor 1\* has to be connected to digital input DI2. Otherwise the Motor ID Run cannot be started.

\*speed-regulated

---



**WARNING!** The motor will run at up to approximately 50% ... 80% of the nominal speed during the Motor ID Run. ENSURE THAT IT IS SAFE TO RUN THE MOTOR BEFORE PERFORMING THE MOTOR ID RUN!

---

**ID Run Procedure**

To perform the Motor ID Run:

---

**Note:** If parameter values (Group 10 to 98) are changed before the ID Run, check that the new settings meet the following conditions:

- [20.01 MINIMUM FREQUENCY](#)  $\leq 0$ .
  - [20.02 MAXIMUM FREQUENCY](#)  $> 80\%$  of motor rated frequency.
  - [20.03 MAXIMUM CURRENT](#)  $\geq 100\%$  of  $I_{hd}$ .
  - [20.04 MAXIMUM TORQUE](#)  $> 50\%$ .
-

1. Ensure that the Panel is in the local control mode (L displayed on the status row). Press the  key to switch modes.
2. Change the selection to STANDARD or REDUCED:

```

1 L      45 Hz      0
99 START-UP DATA
10 MOTOR ID RUN
[STANDARD]
    
```

3. Press **ENTER** to verify selection. The following message will be displayed:



```

1 L      45.0      Hz      0
ACS 600 55 kW
**WARNING**
ID RUN SEL
    
```

4. To start the ID Run, press the  key. The run enable signal must be active (see Parameter [16.01 RUN ENABLE](#) ). If the PFC Macro is selected, the interlocks must be on (see Parameter [81.20 INTERLOCKS](#)).

Warning when the ID Run is started	Warning during the ID Run	Warning after a successfully completed ID Run
<pre> 1 L      45.0      Hz      I ACS 600 55 kW **WARNING** MOTOR STARTS                     </pre>	<pre> 1 L      45.0      Hz      I ACS 600 55 kW **WARNING** ID RUNNING                     </pre>	<pre> 1 L      45.0      Hz      I ACS 600 55 kW **WARNING** ID DONE                     </pre>

In general it is recommended not to press any control panel keys during the ID run. However:

- The Motor ID Run can be stopped at any time by pressing the Control Panel  key or removing the Run enable signal.
- After the ID Run is started with the  key, it is possible to monitor the actual values by first pressing the **ACT** key and then the  key.

## Chapter 4 – Control Operation

### Overview

This chapter describes the Actual Signals, the Fault History, and the Local and External control modes.

### Actual Signals

Actual Signals monitor the functions of the ACS 600, but do not affect its performance. Actual Signal values are measured or calculated by the drive and they cannot be set by the user.

The Actual Signal Display Mode of the Control Panel continuously displays three actual signals.

The default values for the display depend on the selected Application Macro (refer to [Chapter 5 – Application Macros](#)). To select the actual values to be displayed follow the procedure described in [Chapter 2 – Overview of ACS 600 Programming and the CDP 312 Control Panel](#), Table 2-2.

### Group 1 ACTUAL SIGNALS

Table 4-1 Group 1.

Actual Signal	Short Name	Range/Unit	Description
1.01 SPEED	SPEED	rpm	Calculated motor speed in rpm.
1.02 FREQUENCY <sup>1,2)</sup>	FREQ	Hz	Calculated motor frequency.
1.03 CURRENT <sup>1,2)</sup>	CURRENT	A	Measured motor current.
1.04 TORQUE	TORQUE	%	Calculated motor torque. 100 is the motor nominal torque rating.
1.05 POWER	POWER	%	Motor power. 100 is the nominal power rating.
1.06 DC BUS VOLTAGE V	DC BUS V	V	Measured Intermediate circuit voltage.
1.07 MAINS VOLTAGE	MAINS V	V	Calculated supply voltage.
1.08 OUTPUT VOLTAGE	OUT VOLT	V	Calculated motor voltage.
1.09 ACS600 TEMP	ACS TEMP	C	Temperature of the heatsink.
1.10 EXTERNAL REF 1	EXT REF1	rpm, Hz	External reference 1.
1.11 EXTERNAL REF 2	EXT REF2	%	External reference 2.
1.12 CTRL LOCATION <sup>2)</sup>	CTRL LOC	LOCAL; EXT1; EXT2	Active control location. See the section <a href="#">Local Control vs. External Control</a> in this chapter.
1.13 OP HOUR COUNTER	OP HOURS	h	Elapsed time meter. The timer is running when the NAMC board is powered.
1.14 KILOWATT HOURS	KW HOURS	kWh	kWh meter.

Actual Signal	Short Name	Range/Unit	Description
1.15 APPL BLOCK OUTPUT	APPL OUT	%	Application block output signal. See <a href="#">Figure 4-3</a> .
1.16 DI6-1 STATUS	DI6-1		Status of standard digital inputs (DI6-1) and the optional PFC extension module digital input 1 (DI7). 0 V = "0" ; +24 VDC = "1"
1.17 AI1 (V)	AI1 (V)	V	Value of analogue input 1.
1.18 AI2 (mA)	AI2 (mA)	mA	Value of analogue input 2.
1.19 AI3 (mA)	AI3 (mA)	mA	Value of analogue input 3.
1.20 RO3-1 STATUS	RO3-1		Status of relay outputs (RO3-1) and the optional PFC extension module digital outputs (RO5-4). 1= relay is energised ; 0 = relay is de-energised
1.21 AO1 (mA)	AO1 (mA)	mA	Value of analogue output 1.
1.22 AO2 (mA)	AO2 (mA)	mA	Value of analogue output 2.
1.23 ACTUAL VALUE 1 <sup>1)</sup>	ACT VAL1	NO; Bar; %; C; mg/l; kPa	Value of the process feedback signal no.1 received by the process PI Controller. (Ref. to Par <a href="#">80.12 ACTUAL 1 UNIT</a> )
1.24 ACTUAL VALUE 2	ACT VAL2	NO; Bar; %; C; mg/l; kPa	Value of the process feedback signal no.2 received by the process PI Controller. (Ref. to Par <a href="#">80.14 ACTUAL 2 UNIT</a> )
1.25 CONTROL DEVIATION	CONT DEV	%	Deviation of the PI Controller (Difference between the process reference value and the process actual value of the process PI controller).
1.26 PFC OPERATION TIME	PFC OP T	h	Time counted from the latest Autochange. See Parameter Group 81 PFC Control.
1.27 ACTUAL FUNC OUT	ACTUAL F		Result of the arithmetic operation selected with Parameter <a href="#">80.04 ACTUAL VALUE SEL</a>
1.43 MOTOR RUN TIME	MOTOR RU	h	Motor run time counter. The counter runs when the inverter modulates.

1) Default setting for Pump and Fan Control (PFC) Macro.

2) Default setting for Hand/Auto Macro.



**Group 2 ACTUAL SIGNALS**

Using [Group 2 ACTUAL SIGNALS](#), it is possible to monitor the processing of speed and torque references in the drive. For the signal measuring points see [Figure 4-3](#), or the Control Signal Connections figures of the Application Macros ([Chapter 5 – Application Macros](#)).

Table 4-2 Group 2.

Actual Signal	Short Name	Range/ Unit	Description
2.01 SPEED REF 2	S REF 2	%	Limited speed reference. 100% = max. speed.*
2.02 SPEED REF 3	S REF 3	%	Ramped and shaped speed reference. 100% = max. speed.*
2.09 TORQ REF 2	T REF 2	%	Speed controller output. 100% = motor nominal torque.
2.10 TORQ REF 3	T REF 3	%	Torque reference. 100% = motor nominal torque.
2.13 TORQ REF USED	T USED R	%	Torque reference after frequency, voltage and torque limiters. 100% = motor nominal torque.
2.17 SPEED EST	SPEED ES	%	Estimated actual speed of the motor. 100% = max. speed.*

\*Max. speed equals the value of Parameter [20.02 MAXIMUM FREQUENCY](#), or [20.01 MINIMUM FREQUENCY](#) if the absolute value of the minimum limit is greater than the maximum limit.

**Group 3 ACTUAL SIGNALS**

Group 3 contains actual signals mainly for fieldbus use (a master station controls the ACS 600 via a serial communication link). All signals in Group 3 are 16-bit data words, each bit corresponding one piece of binary (0,1) information from the drive to the master station.

The signal values (data words) can also be viewed with the Control Panel in hexadecimal format.

For more information on [Group 3 ACTUAL SIGNALS](#), see [Appendix A – Complete Parameter Settings](#), and [Appendix C – Fieldbus Control](#).

### Fault History

The Fault History includes information on the 16 most recent faults and warnings that occurred in the ACS 600 (or 64, if the power is not switched off meanwhile). The description of the fault and the total power-on time are available. The power-on time is calculated always when the NAMC board of the ACS 600 is powered.

[Chapter 2 – Overview of ACS 600 Programming and the CDP 312 Control Panel](#), Table 2-4, describes how to display and clear the Fault History from the Control Panel.

### Local Control vs. External Control

The ACS 600 can be controlled, i.e. reference, and Start/Stop and Direction commands can be given, from an External control location or from the Local control location.

The selection between Local control and External control can be done with the **LOC REM** key on the Control Panel keypad.

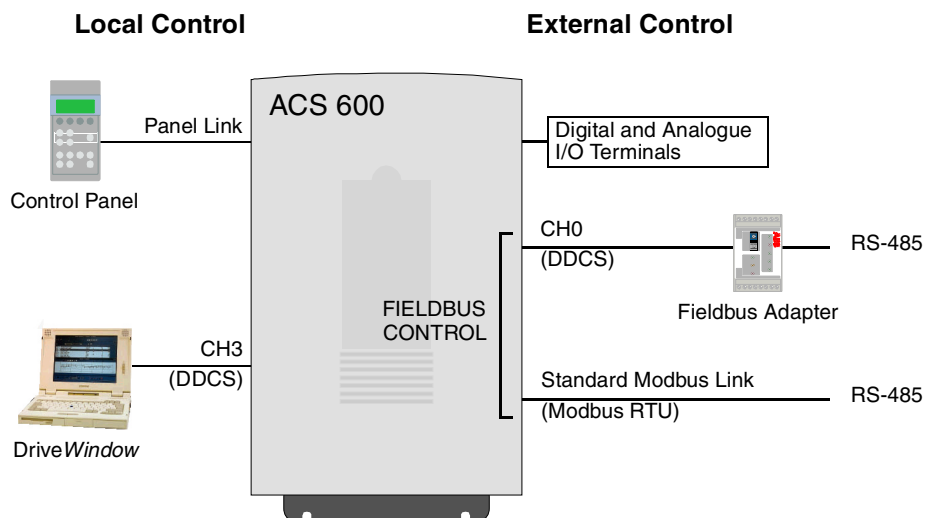
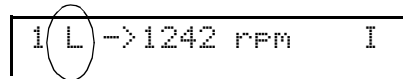

Figure 4-1 Local and external control.

**Local Control** The control commands are given from the Control Panel keypad or from the Drive *Window* PC tool when ACS 600 is in Local control. This is indicated by L on the Control Panel display.



A rectangular display box containing the text "1(L) -> 1242 rpm I". The letter "L" is circled with a thin black line.

**External Control** When the ACS 600 is in External control, the commands are given through the control terminal block on the NIOC board (digital and analogue inputs), optional I/O extension modules and/or either of the two fieldbus interfaces, CH0 Fieldbus Adapter or the Standard Modbus Link. In addition, it is also possible to set the Control Panel as the source for the external control.

External control is indicated by a blank character on the Control Panel display or with an R in those special cases when the Panel is defined as an External control source.

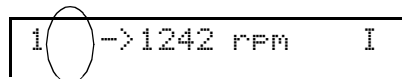

A rectangular display box containing the text "1( ) -> 1242 rpm I". The space character inside the parentheses is circled with a thin black line.

External Control through the Input/Output terminals, or through the fieldbus interfaces

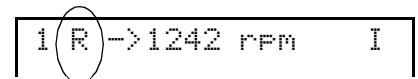

A rectangular display box containing the text "1(R) -> 1242 rpm I". The letter "R" is circled with a thin black line.

External Control by Control Panel (Start/Stop/Direction commands and/or reference given by an "external" Panel)

**Signal Source Selection** In the application program, the user can define signal sources for two external control locations, EXT1 and EXT2, one of which can be active at a time. Parameter [11.02 EXT1/EXT2 SELECT](#) selects between EXT1 and EXT2.

For EXT1, the source of the Start/Stop/Direction commands is defined by Parameter [10.01 EXT1 STRT/STP/DIR](#), and the reference source is defined by Parameter [11.03 EXT REF1 SELECT](#). External reference 1 is always a frequency reference.

The figure below illustrates the signal source selection for EXT1.

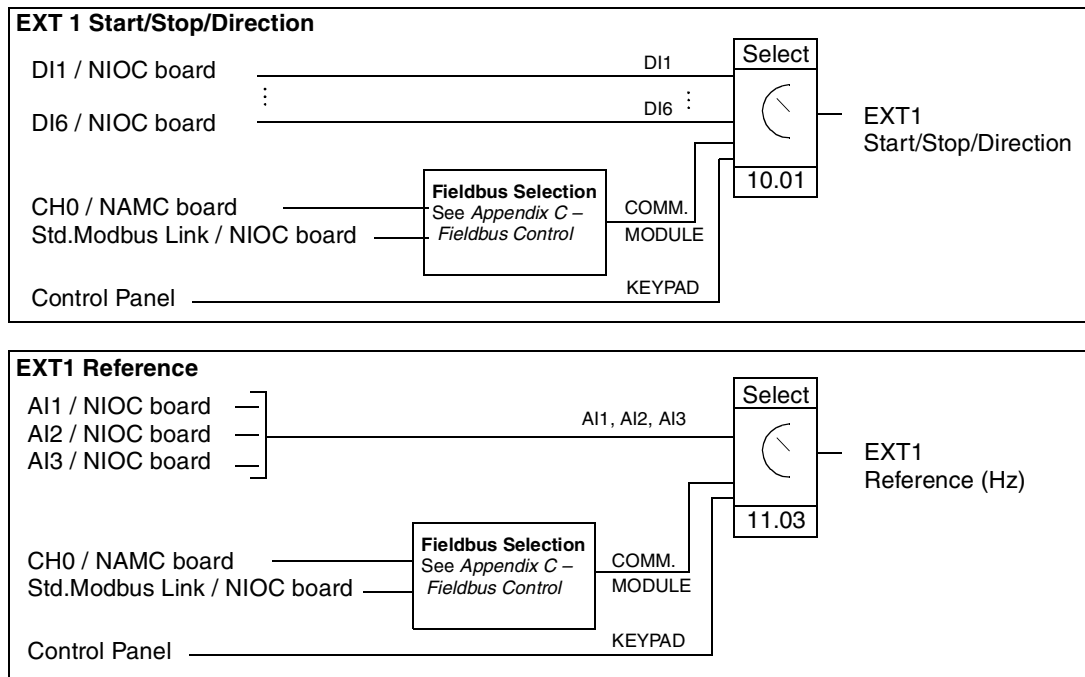

Figure 4-2 Block diagram of the EXT1 signal source selection.

For EXT2, the source of the Start/Stop/Direction commands is defined by Parameter [10.02 EXT2 STRT/STP/DIR](#), and the reference source is defined by Parameter [11.06 EXT REF2 SELECT](#). External reference 2 is the reference for the process PI controller when the PFC Macro is used. With the Hand/Auto Macro, External reference 2 is a percentage reference of the maximum frequency.

If the ACS 600 is in External control, constant frequency operation can also be selected by setting Parameter [12.01 CONST FREQ SEL](#). One of three constant frequencies can be selected with digital inputs.

**Constant frequency selection overrides the external speed reference signal.**

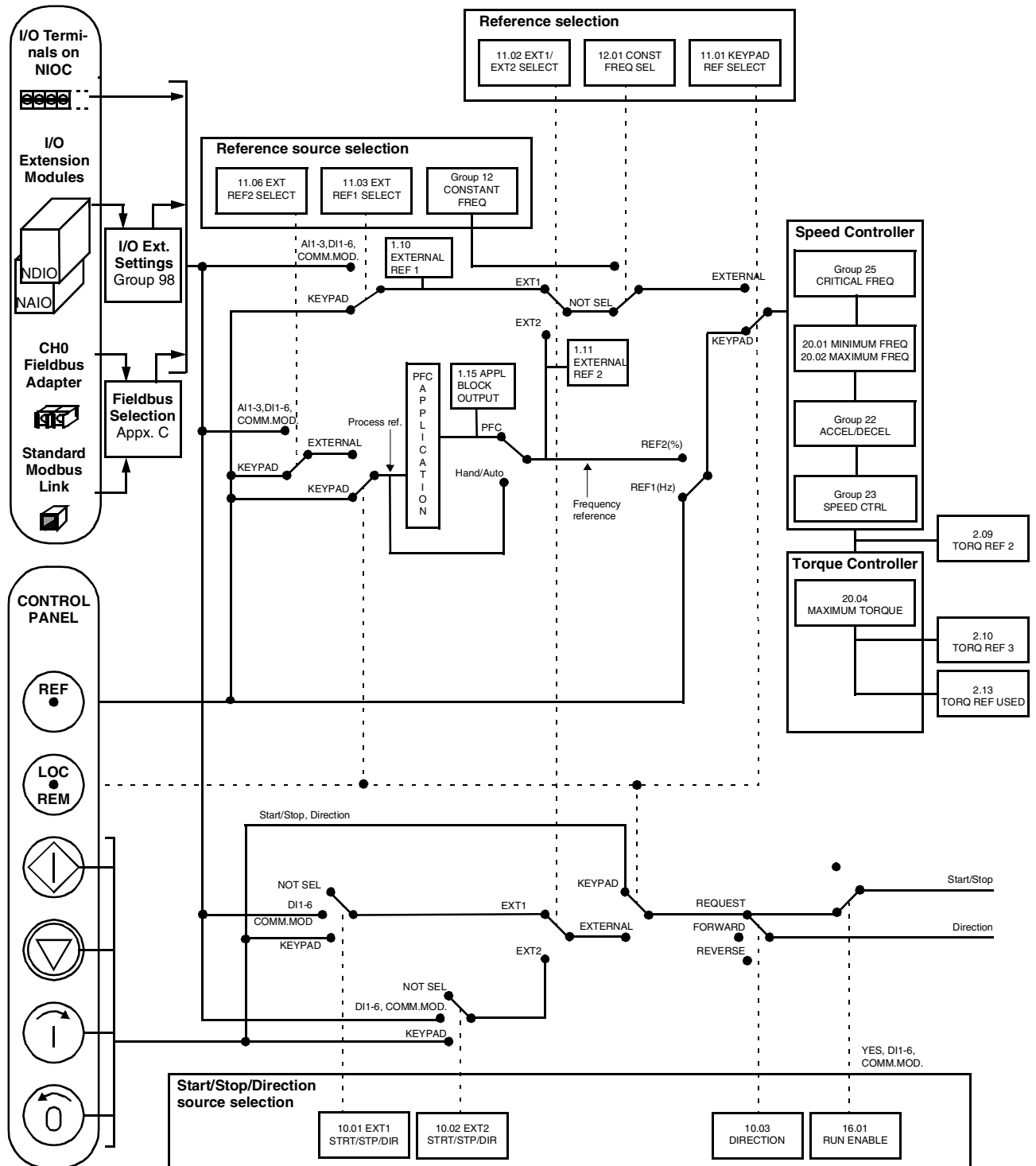

Figure 4-3 Selecting control location and control source.



# Chapter 5 – Application Macros

---

## Overview

This chapter contains descriptions of Pump and Fan Control (PFC), Hand/Auto and two User macros. The default Parameter Settings are given in [Appendix A – Complete Parameter Settings](#).

## Application Macros

Application Macros are preprogrammed parameter sets. Using the Application Macros enables a quick and easy start-up of the ACS 600.

Application Macros minimise the number of different parameters to be set during start-up. All parameters have factory-set default values. The Pump and Fan Control (PFC) Macro is the default macro.

While starting up the ACS 600, you can select either PFC or Hand/Auto Macro as the default for your ACS 600.

The Application Macro default values are chosen to represent the average values in a typical application. Check that the default settings match your requirements and customise the settings when appropriate. All inputs and outputs are programmable.

---

**Note:** When you change the parameter values of the PFC or Hand/Auto macro, the new settings become active immediately and stay active even if the power of the ACS 600 is switched off and on. However, the default parameter settings of each macro loaded at the factory are still available. The default settings are restored when Parameter [99.03 APPLIC RESTORE](#) is changed to YES, or if the macro is changed.

---

**Note:** There are certain parameters that remain the same even though the macro were changed to another, or the default settings of the macro were restored. For more information, see [Chapter 3 – Start-up Data](#), section [99.03 APPLIC RESTORE](#).

---

### **Pump and Fan Control (PFC) Macro**

Pump and Fan Control (PFC) macro can operate a pump (or fan or compressor) station with one to four parallel pumps. The control principle of a two-pump station is as follows:

- The motor of pump 1 is connected to the ACS 600. The capacity of the pump is controlled by varying the motor speed.
- The motor of pump 2 is connected direct-on-line. The pump can be switched on and off by the ACS 600 when necessary.
- The process reference and actual value are fed to the PI controller included in the PFC macro. The PI controller adjusts the speed (frequency) of pump 1 such that the process actual value follows the reference. When the frequency reference of the process PI controller exceeds the limit set by the user, the PFC macro automatically starts pump 2. When the frequency falls below the limit set by the user, the PFC macro automatically stops pump 2.
- Using the digital inputs of the ACS 600, an interlocking function can be implemented; the PFC macro detects if a pump is switched off and starts the other pump instead.
- The PFC macro makes automatic pump alternation possible (not in use in [Figure 5-1](#)) so both pumps have an equal duty time. For more information on the alternation system and other useful features such as the Sleep function, Constant reference value, Reference steps and Regulator by-pass, see [Chapter 6 – Parameters \(Group 81 PFC CONTROL\)](#).

By default, the ACS 600 receives process reference (setpoint) through analogue input AI1, process actual value through analogue input AI2 and Start/Stop commands through digital input DI6. The interlocks are connected to digital input DI2 (Motor 1) and digital input DI3 (Motor 2).

The default output signals are given through analogue output AO1 (frequency) and AO2 (actual value of the process PI controller).

If the Control Panel is in Local control mode (“L” visible on the first row of the display), ACS 600 follows the frequency reference given from the Panel. The automatic Pump and Fan Control (PFC) is bypassed: no process PI controller is in use and the constant speed motors are not started.



### Operation Diagram

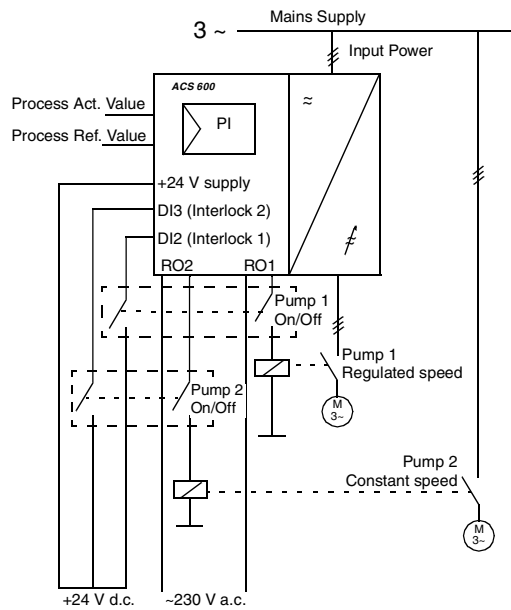

```

1 L -> 45.0 Hz I
ACT VAL1 10.00 bar
CURRENT 80.00 A
FREQ 45.00 Hz
    
```

Reference, Start/Stop, and Direction commands are given from the Control Panel. To change to External, press **LOC REM**.

```

1 -> 45.0 Hz I
ACT VAL1 10.00 bar
CURRENT 80.00 A
FREQ 45.00 Hz
    
```

Reference is read from analogue input AI2. Start/Stop commands are given through digital input DI6.

Figure 5-1 Operation Diagram for the Pump and Fan Control (PFC) Macro. Note that automatic pump alternation is not in use with the default settings.

**External Connections** The following connection example is applicable when the PFC Macro settings are used.

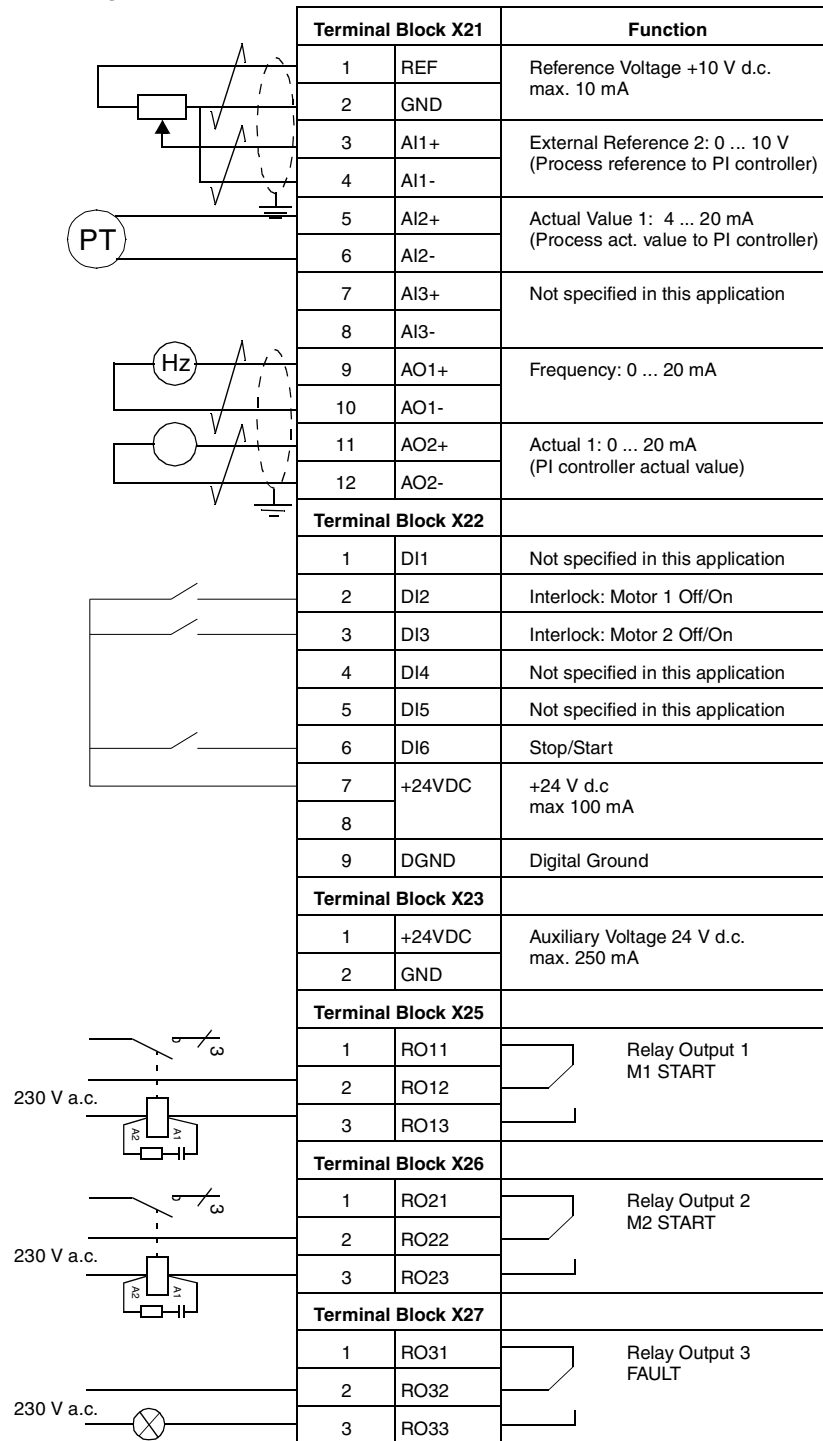

Figure 5-2 Default external control connections for Pump and Fan Control (PFC) Application Macro. The markings of the NIOC board terminals are given above. In ACS 601 and ACS 604, user connections are always made directly to the input and output terminals of the NIOC board. In ACS 607, the connections are made either directly to NIOC board, or the I/O terminals of the NIOC board are wired to an optional, separate terminal block intended for the user connections. See the appropriate hardware manual for the corresponding terminal markings.

**Control Signal Connections**

Control signals i.e. Reference, Start, Stop and Direction command connections are established as shown in Figure 5-3 when you select the Pump and Fan Control (PFC) Macro.

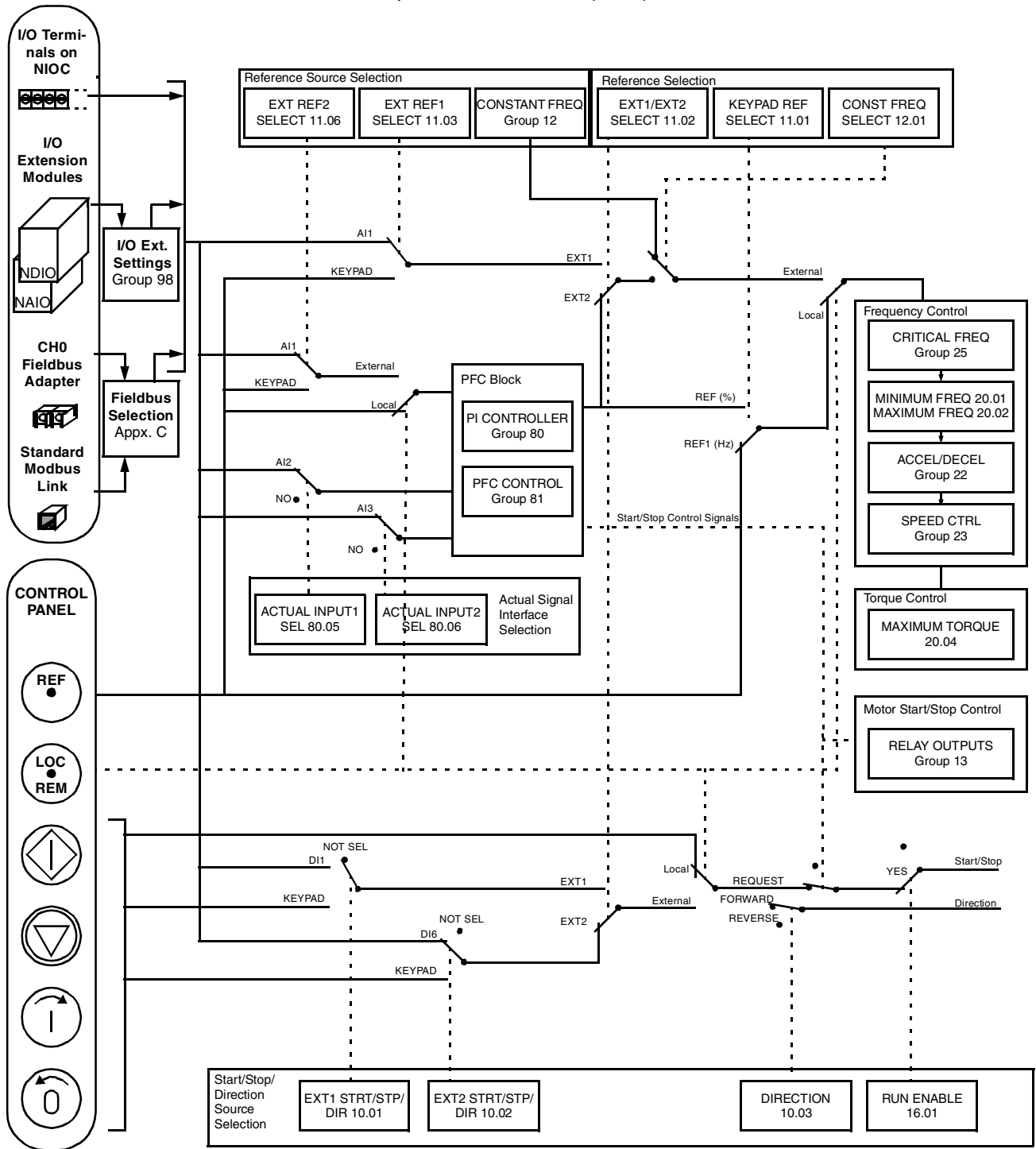

Figure 5-3 Control Signal connections for the Pump and Fan Control (PFC) Macro.

**Hand/Auto  
Application Macro**

Start/Stop commands and reference settings can be given from one of two external control locations, EXT1 (Hand) or EXT2 (Auto). The Start/Stop commands of the EXT1 (Hand) are connected to digital input DI1, and the reference signal is connected to analogue input AI1. The Start/Stop commands of the EXT2 (Auto) are connected to digital input DI6, and the reference signal is connected to analogue input AI2. The selection between EXT1 and EXT2 is dependent on the status of digital input DI5. The drive is frequency-controlled.

Frequency reference and Start/Stop commands can also be given from the Control Panel keypad.

Frequency reference in Auto Control (EXT2) is given as a percentage of the maximum frequency of the drive (see parameters 11.07 EXT REF2 MINIMUM and 11.08 EXT REF2 MAXIMUM).

Two analogue and three relay output signals are available on terminal blocks. Default signals for the Actual Signal Display Mode of the Control Panel are FREQUENCY, CURRENT and CTRL LOC.

**Operation Diagram**

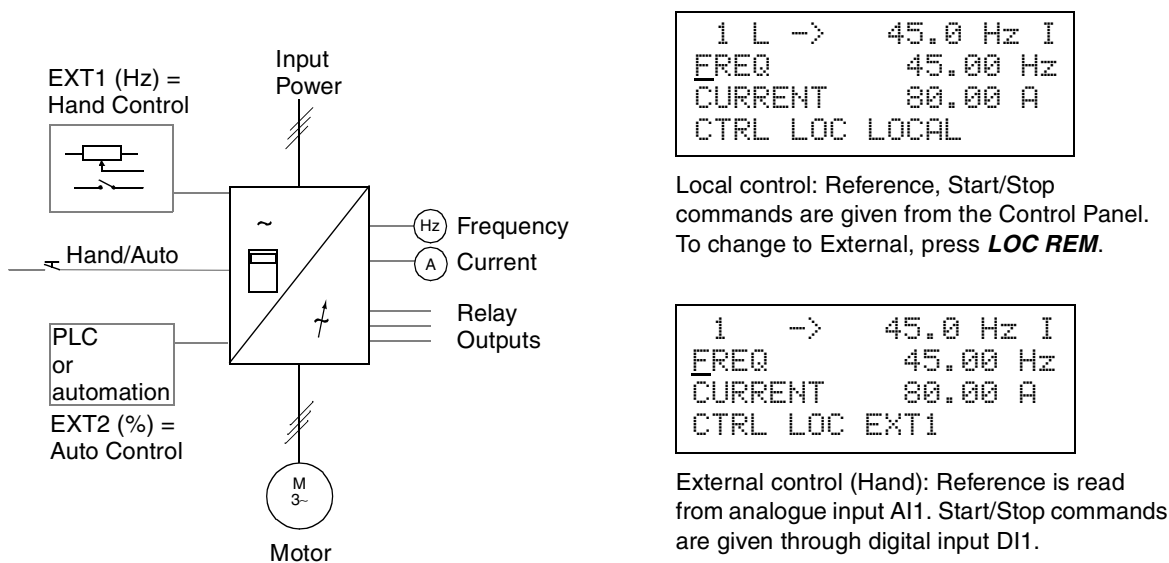

Figure 5-4 Operation Diagram for the Hand/Auto Macro.

**External Connections**

The following connection example is applicable when the Hand/Auto Macro settings are used.

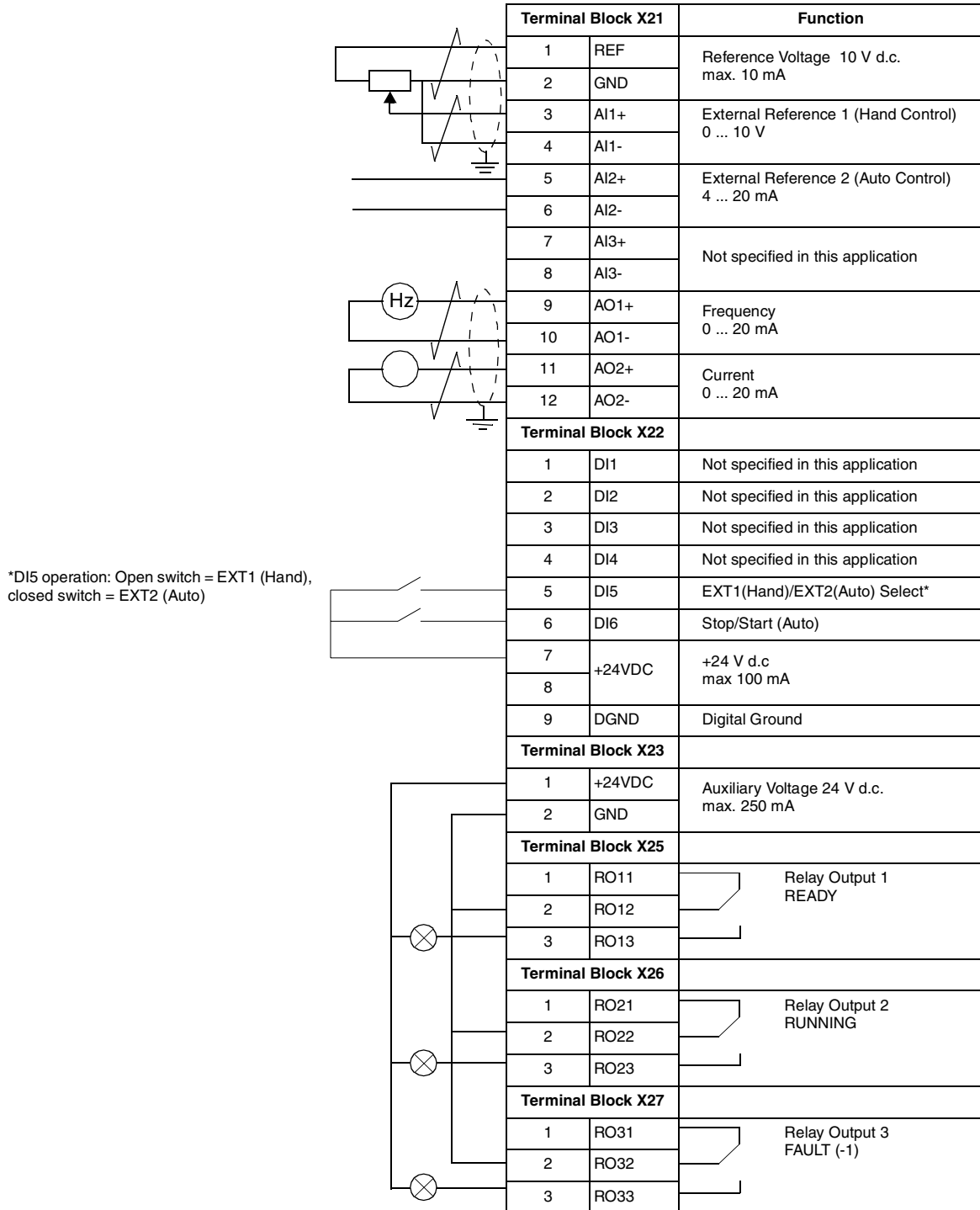

Figure 5-5 Control Connections for Hand/Auto Application Macro. The markings of the NIOC board terminals are given above. In ACS 601 and ACS 604, user connections are always made directly to the input and output terminals of the NIOC board. In ACS 607, the connections are made either directly to NIOC board, or the I/O terminals of the NIOC board are wired to an optional, separate terminal block intended for the user connections. See the appropriate hardware manual for the corresponding terminal markings.

**Control Signal Connections**

Control signals i.e. Reference, Start and Stop commands are established as shown in [Figure 5-6](#) when you select the Hand/Auto Macro.

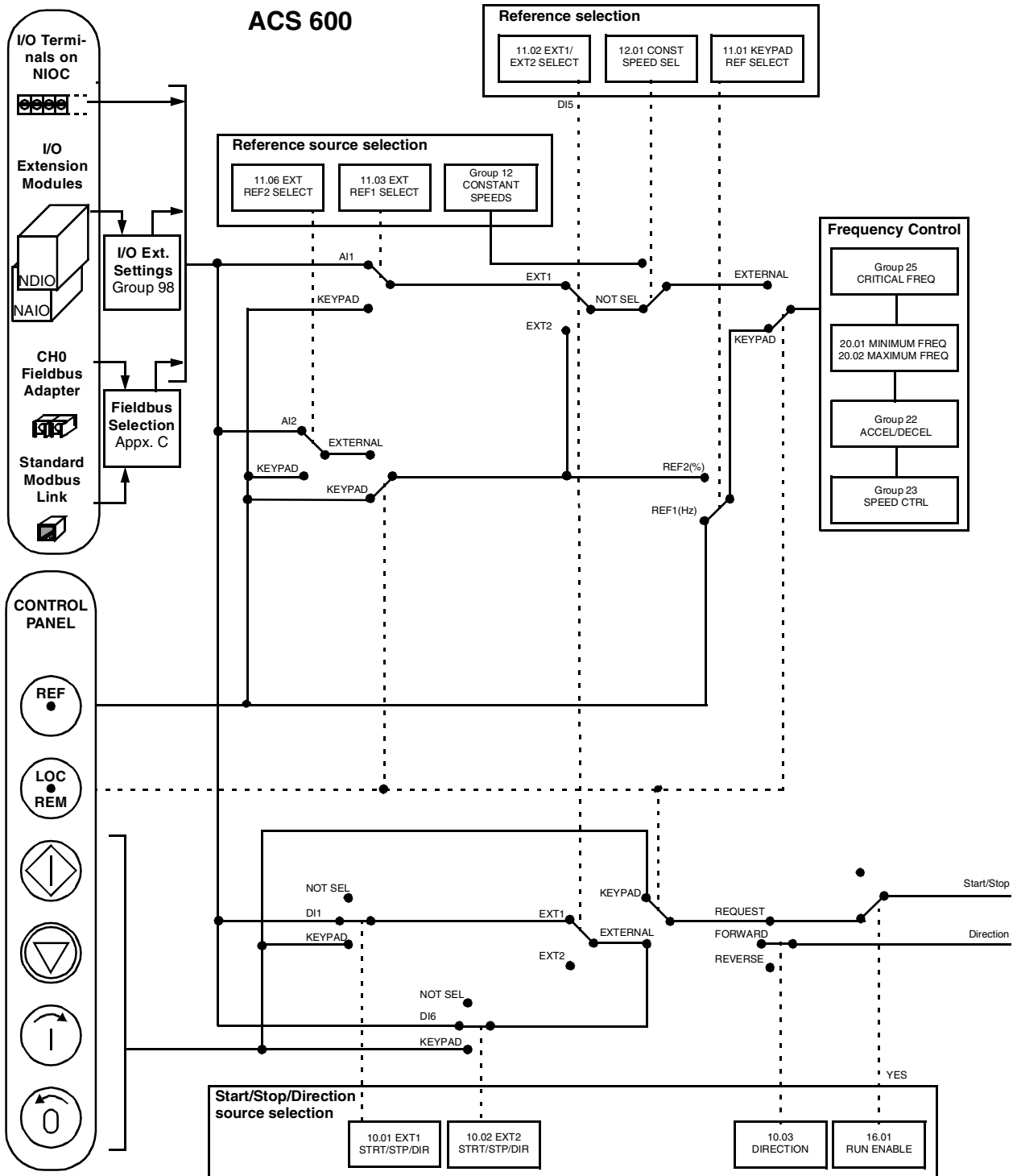

Figure 5-6 Control Signal connections for the Hand/Auto Macro.

## User Macros

In addition to the standard Application Macros, it is possible to create two User Macros. The User Macro allows the user to save the Parameter settings including Group 99, and the results of the motor identification into the permanent memory<sup>1)</sup>, and recall the data at a later time.

To create User Macro 1:

1. Adjust the Parameters. Perform the motor identification if not yet performed.
2. Save the parameter settings and the results of the motor identification by changing Parameter [99.02 APPLICATION MACRO](#) to USER 1 SAVE (press **ENTER**). The storing will take a few minutes.

To recall the User Macro:

1. Change Parameter [99.02 APPLICATION MACRO](#) to USER 1 LOAD.
2. Press **ENTER** to load.

The User Macro can also be switched via digital inputs (see Parameter [16.05 USER MACRO IO CHG](#)).

---

**Note:** User Macro load restores also the motor settings of the Start-up Data group and the results of the motor identification. Check that the settings correspond to the motor used.

---

**Example:** User Macros make it possible to switch the ACS 600 between two motors without having to adjust the motor parameters and to repeat the motor identification every time the motor is changed. The user can simply adjust the settings and perform the motor identification once for both motors, and then save the data as two User Macros. When the motor is changed, only the corresponding User Macro needs to be loaded and the drive is ready to operate.

<sup>1)</sup> The panel reference and the control location setting (Local/Remote) are also saved.





# Chapter 6 – Parameters

## Overview

This chapter explains the function of, and valid selections for, each ACS 600 parameter.

## Parameter Groups

The parameters of the ACS 600 are arranged into groups by their function. [Figure 6-1](#) illustrates the organisation of the parameter groups. [Chapter 2 – Overview of ACS 600 Programming and the CDP 312 Control Panel](#) explains how to select and set the parameters. Refer to [Chapter 3 – Start-up Data](#) and [Chapter 4 – Control Operation](#) for more information on the Start-up Data and Actual Signals. Some parameters that are not in use in the current application are hidden to simplify programming.

**CAUTION!** Exercise caution when configuring input/output connections, as it is possible (albeit not recommended) to use one I/O connection for multiple operations. If an I/O is assigned a function, the setting remains in effect even if you select the I/O for another function with another parameter.

**Note:** Some parameters cannot be adjusted while the motor is running. Attempting to do so will produce the message “WRITE ACCESS DENIED PARAMETER SETTING NOT POSSIBLE”.

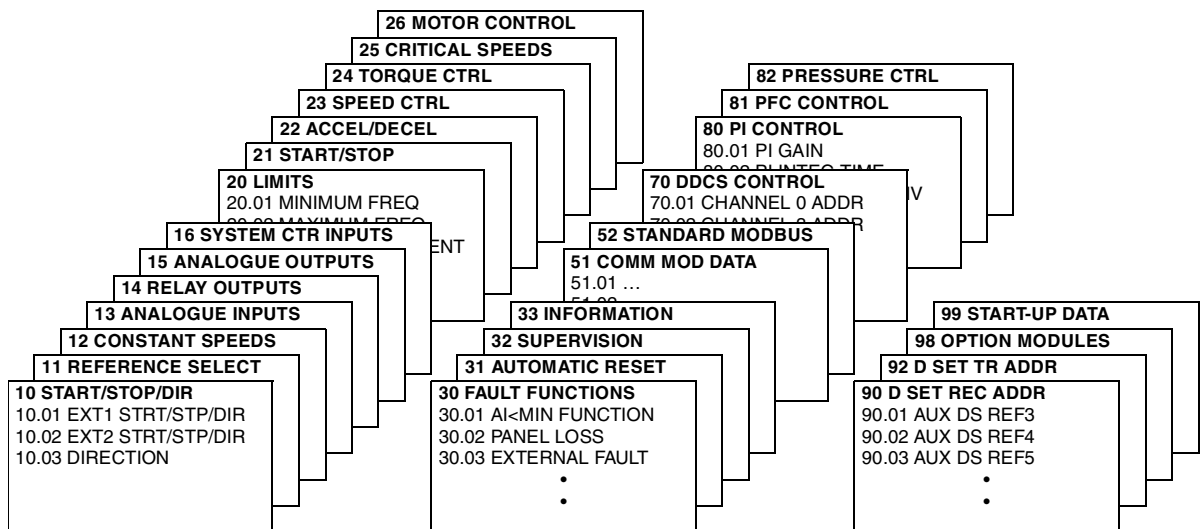

Figure 6-1 Parameter Groups.

**Group 10  
START/STOP/DIR**

The Range/Unit column in [Table 6-1](#) shows the allowable parameter values. The text following the table explains the parameters in detail.

Table 6-1 Group 10.

Parameter	Range/Unit	Description
10.01 EXT1 STRT/STP/DIR	NOT SEL; Digital Inputs; KEYPAD; COMM. MODULE	Selects source of Start/Stop/ Direction commands for External control location EXT1.
10.02 EXT2 STRT/STP/DIR	NOT SEL; Digital Inputs; KEYPAD; COMM. MODULE	Selects source of Start/Stop/ Direction commands for External control location EXT2.
10.03 DIRECTION	FORWARD; REVERSE; REQUEST	Rotation direction lock.

Start, Stop and Direction commands can be given from the keypad or from two external locations. The selection between the two external locations is made using Parameter [11.02 EXT1/EXT2 SELECT](#). For more information on control locations refer to [Chapter 4 – Control Operation](#).

**10.01 EXT1  
STRT/STP/DIR**

This parameter defines the connections and the source of Start, Stop and Direction commands for External control location 1 (EXT1).

**NOT SEL**

No Start, Stop and Direction command source for EXT1 is selected.

**D11**

Two-wire Start/Stop, connected to digital input D11. 0 V DC on D11 = Stop; 24 V DC on D11 = Start. Direction of rotation is fixed according to Parameter [10.03 DIRECTION](#).



**WARNING!** After a fault reset, the drive will start if the start signal is on.

**D11,2**

Two-wire Start/Stop. Start/Stop is connected to digital input D11 as above. Direction is connected to digital input D12. 0 V DC on D12 = Forward; 24 V DC on D12 = Reverse. To control Direction, value of Parameter [10.03 DIRECTION](#) should be REQUEST.



**WARNING!** After a fault reset, the drive will start if the start signal is on.

**DI1P,2P**

Three-wire Start/Stop. Start/Stop commands are given by means of momentary push-buttons (the P stands for “pulse”). The Start push-button is normally open, and connected to digital input DI1. The Stop push-button is normally closed, and connected to digital input DI2. Multiple Start push-buttons are connected in parallel; multiple Stop push-buttons are connected in series. Direction of rotation is fixed according to Parameter [10.03 DIRECTION](#).

**DI1P,2P,3**

Three-wire Start/Stop. Start/Stop connected as with DI1P,2P. Direction is connected to digital input DI3. 0 V DC on DI3 = Forward; 24 V DC on DI3 = Reverse. To control Direction, value of Parameter [10.03 DIRECTION](#) should be REQUEST.

**DI1P,2P,3P**

Start Forward, Start Reverse, and Stop. Start and Direction commands are given simultaneously with two separate momentary push-buttons (the P stands for “pulse”). The Stop push-button is normally closed, and connected to digital input DI3. The Start Forward and Start Reverse push-buttons are normally open, and connected to digital inputs DI1 and DI2 respectively. Multiple Start push-buttons are connected in parallel, and multiple Stop push-buttons are connected in series. To control Direction, value of Parameter [10.03 DIRECTION](#) should be REQUEST.

**DI6**

Two-wire Start/Stop, connected to digital input DI6. 0 V DC on DI6 = Stop and 24 V DC on DI6 = Start. Direction of rotation is fixed according to Parameter [10.03 DIRECTION](#).



**WARNING!** After a fault reset, the drive will start if the start signal is on.

---

**DI6,5**

Two-wire Start/Stop. Start/Stop is connected to digital input DI6. Direction is connected to digital input DI5. 0 V DC on DI5 = Forward and 24 V DC on DI5 = Reverse. To control Direction, value of Parameter [10.03 DIRECTION](#) should be REQUEST.



**WARNING!** After a fault reset, the drive will start if the start signal is on.

---

**KEYPAD**

The Start/Stop and Direction commands are given from the Control Panel keypad when External control location 1 is active. To control Direction, value of Parameter [10.03 DIRECTION](#) should be REQUEST.

**COMM. MODULE**

The Start/Stop and Direction commands are given through a communication (e.g. fieldbus adapter) module.

**10.02 EXT2 STRT/STP/DIR** Defines the connections and the source of Start, Stop and Direction commands for External control location 2 (EXT2).

**NOT SEL; DI1; DI1,2; DI1P,2P; DI1P,2P,3; DI1P,2P,3P; DI6; DI6,5; KEYPAD; COMM. MODULE**

Refer to Parameter [10.01 EXT1 STRT/STP/DIR](#) above for details on these settings.

**10.03 DIRECTION** Allows you to fix the direction of rotation of the motor to **FORWARD** or **REVERSE**. If you select **REQUEST**, the direction is selected as defined by Parameters [10.01 EXT1 STRT/STP/DIR](#) and [10.02 EXT2 STRT/STP/DIR](#) or by keypad push-buttons.

---

**Note:** If the PFC Macro is in use and External reference 2 is the active reference for the ACS 600, this parameter is fixed to FORWARD. No other setting is accepted. The same restriction is valid in Local control (i.e. Control Panel is the active control device) when the value of Parameter [11.01 KEYPAD REF SEL](#) is REF2 (%). With the Hand/Auto Macro, there is no restriction for the direction.

---

**Group 11 REFERENCE  
SELECT**

The Range/Unit column in [Table 6-2](#) shows the allowable parameter values. The text in the table below explains the parameters in detail.

Table 6-2 Group 11.

Parameter	Range/Unit	Description
11.01 KEYPAD REF SEL	REF1 (Hz); REF2 (%)	Selection of active keypad reference.
11.02 EXT1/EXT2 SELECT	DI1 ... DI6; EXT1; EXT2; COMM. MODULE	External control location selection input.
11.03 EXT REF1 SELECT	KEYPAD; Analogue Inputs; COMM. MODULE	External reference 1 input.
11.04 EXT REF1 MINIMUM	0 ... 120 Hz	External reference 1 minimum value.
11.05 EXT REF1 MAXIMUM	0 ... 120 Hz	External reference 1 maximum value.
11.06 EXT REF2 SELECT	KEYPAD; Analogue Inputs; COMM. MODULE	External reference 2 input.
11.07 EXT REF2 MINIMUM	0 ... 100%	External reference 2 minimum value.
11.08 EXT REF2 MAXIMUM	0 ... 500%	External reference 2 maximum value.

Reference can be set from the keypad or from two external locations. Refer to [Chapter 4 – Control Operation](#), section [Local Control vs. External Control](#).

**11.01 KEYPAD REF SEL****REF1 (Hz)**

Keypad reference 1 is selected as the active keypad reference. The type of the reference is frequency, given in Hz.

**REF2 (%)**

Keypad reference 2 is selected as the active keypad reference. Keypad reference 2 is given in %. The type of Keypad reference 2 depends on the selected Application Macro. If the PFC Macro is selected, REF 2 (%) is process reference. If Hand/Auto Macro is selected REF2 (%) is a relative frequency reference.

**11.02 EXT1/EXT2  
SELECT**

This parameter sets the input used for selecting the external control location, or fixes it to EXT1 or EXT2. The external control location of both Start/Stop/Direction commands and reference is determined by this parameter.

**EXT1**

External control location 1 is selected. The control signal sources for EXT1 are defined with Parameters [10.01 EXT1 STRT/STP/DIR](#) (Start/Stop/Direction commands) and [11.03 EXT REF1 SELECT](#) (reference).

**EXT2**

External control location 2 is selected. The control signal sources for EXT2 are defined with Parameters [10.02 EXT2 STRT/STP/DIR](#) (Start/Stop/Direction commands) and [11.06 EXT REF2 SELECT](#) (reference).

**DI1 ... DI6**

External control location 1 or 2 is selected according to the state of the selected digital input (DI1 ... DI6), where 0 V DC = EXT1 and 24 V DC = EXT2.

**COMM. MODULE**

External control location 1 or 2 is chosen through a communication (e.g. fieldbus adapter) module.

**11.03 EXT REF1  
SELECT**

This parameter selects the signal source of External reference 1.

**KEYPAD**

Reference is given from the Control Panel keypad. The first line on the display shows the reference value.

**AI1**

Reference from analogue input AI1 (voltage signal).

**AI2**

Reference from analogue input AI2 (current signal).

**AI3**

Reference from analogue input AI3 (current signal).

**AI1+AI3; AI2+AI3; AI1-AI3; AI2-AI3; AI1\*AI3; AI2\*AI3; MIN(AI1,AI3); MIN(AI2,AI3); MAX(AI1,AI3); MAX(AI2,AI3)**

The reference is calculated from the selected input signals according to the mathematical function.

**COMM. MODULE**

The reference is given through a communication (e.g. fieldbus adapter) module.

**11.04 EXT REF1  
MINIMUM**

This parameter sets the minimum frequency reference in Hz. The value corresponds to the minimum of the analogue input signal connected to REF1 (value of Parameter [11.03 EXT REF1 SELECT](#) is AI1, AI2 or AI3). See [Figure 6-2](#).

---

**Note:** If the reference is given through the communication module (e.g. fieldbus adapter), the scaling differs from that of an analogue signal. See [Appendix A – Complete Parameter Settings](#) for more information.

---

- 11.05 EXT REF1  
MAXIMUM** This parameter sets the maximum frequency reference in Hz. The value corresponds to the maximum of the analogue input signal connected to REF1 (value of Parameter [11.03 EXT REF1 SELECT](#) is AI1, AI2 or AI3). See [Figure 6-2](#).
- 
- Note:** If the reference is given through the communication module (e.g. fieldbus adapter), the scaling differs from that of an analogue signal. See [Appendix C – Fieldbus Control](#) for more information.
- 
- 11.06 EXT REF2  
SELECT** This parameter selects the signal source for External reference 2. The alternatives are the same as with External reference 1.
- 11.07 EXT REF2  
MINIMUM** This parameter sets the minimum reference in percent. The value corresponds to the minimum of the analogue input signal connected to REF2 (value of Parameter [11.06 EXT REF2 SELECT](#) is AI1, AI2 or AI3). See [Figure 6-2](#).
- If the PFC Macro is selected, this parameter sets the minimum process reference. The value is given as a percentage of the maximum process quantity.
  - If the Hand/Auto Macro is selected, this parameter sets the minimum frequency reference. The value is given as a percentage of the maximum frequency defined with Parameter [20.02 MAXIMUM FREQUENCY](#), or [20.01 MINIMUM FREQUENCY](#) if the absolute value of the minimum limit is greater than the maximum limit.
- 
- Note:** If the reference is given through the communication module (e.g. fieldbus adapter), the scaling differs from that of an analogue signal. See [Appendix C – Fieldbus Control](#) for more information.
- 
- 11.08 EXT REF2  
MAXIMUM** This parameter sets the maximum reference in percent. The value corresponds to the maximum of the analogue signal connected to REF2 (value of Parameter [11.06 EXT REF2 SELECT](#) is AI1, AI2 or AI3). See [Figure 6-2](#).
- If the PFC Macro is selected, this parameter sets the maximum process reference. The value is given as a percentage of the maximum process quantity.
  - If the Hand/Auto Macro is selected, this parameter sets the maximum frequency reference. The value is given as a percentage of the maximum frequency defined with Parameter [20.02 MAXIMUM FREQUENCY](#), or [20.01 MINIMUM FREQUENCY](#) if the absolute value of the minimum limit is greater than the maximum limit.

---

**Note:** If the reference is given through the communication module (e.g. fieldbus adapter), the scaling differs from that of an analogue signal. See [Appendix C – Fieldbus Control](#) for more information.

---

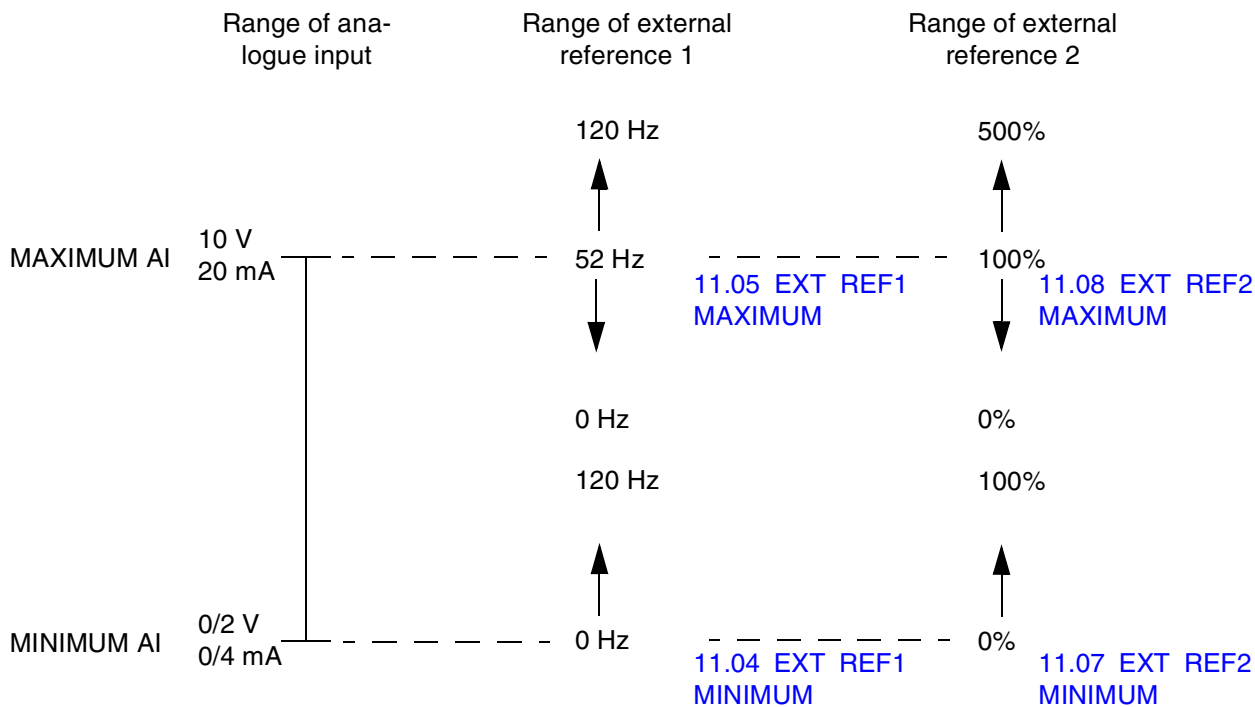

Figure 6-2 Setting EXT REF MINIMUM and MAXIMUM. The range of the analogue input signal is set by Parameter [13.02 MAXIMUM AI1](#), [13.07 MAXIMUM AI2](#), [13.12 MAXIMUM AI3](#) and Parameter [13.01 MINIMUM AI1](#), [13.06 MINIMUM AI2](#), [13.11 MINIMUM AI3](#), depending on the analogue input used. EXT REF2 is a frequency reference for the motor, or a process reference depending on the selected Application Macro.



**Group 12 CONSTANT  
FREQ**

The Range/Unit column in [Table 6-3](#) below shows the allowable parameter values. The text following the table explains the parameters in detail.

*Table 6-3 Group 12.*

Parameter	Range/Unit	Description
12.01 CONST FREQ SEL	NOT SEL; Digital inputs	Const. freq. selection
12.02 CONST FREQ 1	0 ... 120 Hz	Constant frequency 1
12.03 CONST FREQ 2	0 ... 120 Hz	Constant frequency 2
12.04 CONST FREQ 3	0 ... 120 Hz	Constant frequency 3

Constant frequencies override any other references.

---

**Note:** If the PFC Macro is in use and Parameter [12.01 CONST FREQ SEL](#) is set to a value other than NOT SEL and one of the selected digital inputs is ON, the PFC logic is bypassed, i.e. no process PI controller is in use and the constant speed motors are not started.

---

**12.01 CONST FREQ SEL**

This parameter defines which digital inputs are used to select Constant frequencies.

**NOT SEL**

Constant frequency function disabled.

**DI4 (FREQ1); DI5 (FREQ2)**

Constant frequencies 1 and 2 are selected with digital inputs.  
24 V d.c. = Constant frequency is activated.

**DI4,5**

Three Constant frequencies (1 ... 3) are selected with two digital inputs according to [Table 6-4](#) below.

*Table 6-4 Constant frequency selection with digital inputs DI4 and DI5.*

DI4	DI5	Function
0	0	No constant frequency
1	0	Constant Frequency 1
0	1	Constant Frequency 2
1	1	Constant Frequency 3

**12.02 CONST FREQ 1**

Programmable Constant frequency in the range of 0 to 120 Hz.

**12.03 CONST FREQ 2**

Programmable Constant frequency in the range of 0 to 120 Hz.

**12.04 CONST FREQ 3**

Programmable Constant frequency in the range of 0 to 120 Hz.

**Group 13 ANALOGUE INPUTS**

The Range/Unit column in [Table 6-5](#) below shows the allowable parameter values. The text following the table explains the parameters in detail.

*Table 6-5 Group 13.*

Parameter	Range/Unit	Description
13.01 MINIMUM AI1	0 V; 2 V; TUNED VALUE; TUNE	Minimum value of AI1. Value to correspond to minimum reference.
13.02 MAXIMUM AI1	10 V; TUNED VALUE; TUNE	Maximum value of AI1. Value to correspond to maximum reference.
13.03 SCALE AI1	0 ... 100.0%	Scaling factor for AI1.
13.04 FILTER AI1	0 ... 10 s	Filter time constant for AI1.
13.05 INVERT AI1	NO; YES	Analogue input signal 1 inversion.
13.06 MINIMUM AI2	0 mA; 4 mA; TUNED VALUE; TUNE	Minimum value of AI2. Value to correspond to minimum reference.
13.07 MAXIMUM AI2	20 mA; TUNED VALUE; TUNE	Maximum value of AI2. Value to correspond to maximum reference.
13.08 SCALE AI2	0 ... 100.0%	Scaling factor for AI2.
13.09 FILTER AI2	0 ... 10 s	Filter time constant for AI2.
13.10 INVERT AI2	NO; YES	Analogue input signal 2 inversion.
13.11 MINIMUM AI3	0 mA; 4 mA; TUNED VALUE; TUNE	Minimum value of AI3. Value to correspond to minimum reference.
13.12 MAXIMUM AI3	20 mA; TUNED VALUE; TUNE	Maximum value of AI3. Value to correspond to maximum reference.
13.13 SCALE AI3	0 ... 100.0%	Scaling factor for AI3.
13.14 FILTER AI3	0 ... 10 s	Filter time constant for AI3.
13.15 INVERT AI3	NO; YES	Analogue input signal 3 inversion.

**13.01 MINIMUM AI1 0 V; 2 V; TUNED VALUE; TUNE**

This parameter sets the minimum value of the signal to be applied to AI1. If AI1 is selected as the signal source for external reference 1 (Par. [11.03 EXT REF1 SELECT](#)) or external reference 2 (Par. [11.06 EXT REF2 SELECT](#)), this value will correspond to the reference defined by Parameter [11.04 EXT REF1 MINIMUM](#) or [11.07 EXT REF2 MINIMUM](#). Typical minimum values are 0 V or 2 V.

To tune the minimum value according to the analogue input signal, press **ENTER**, select TUNE, apply the minimum analogue input signal and press **ENTER** again. The value is now set as the minimum. The readable range in tuning is 0 V to 10 V. The text TUNED VALUE is displayed after the TUNE operation.

The ACS 600 has a “floating zero” function which allows the protection and supervision circuitry to detect a loss of control signal. To enable this feature, the minimum input signal must be set higher than 0.5 V and Parameter [30.01 AI<MIN FUNCTION](#) must be set accordingly.

**13.02 MAXIMUM AI1 10 V; TUNED VALUE; TUNE**

This parameter sets the maximum value of the signal to be applied to AI1. If AI1 is selected as the signal source for external reference 1 (Par. [11.03 EXT REF1 SELECT](#)) or external reference 2 (Par. [11.06 EXT REF2 SELECT](#)), this value will correspond to the reference defined by Parameter [11.05 EXT REF1 MAXIMUM](#) or [11.08 EXT REF2 MAXIMUM](#). A typical maximum value is 10 V.

To tune the maximum value according to the analogue input signal, press **ENTER**, select TUNE, apply the maximum analogue input signal and press **ENTER** again. The value is now set as the maximum. The readable range in tuning is 0 V to 10 V. The text TUNED VALUE is displayed after TUNE operation.

**13.03 SCALE AI1** Scaling factor for analogue input AI1 signal. See [Figure 6-4](#).

**13.04 FILTER AI1** Filter time constant for analogue input AI1. As the analogue input value changes, 63% of the change takes place within the time specified by this parameter.

---

**Note:** Even if you select 0 s as the minimum value, the signal is still filtered with a time constant of 10 ms due to the signal interface hardware. This cannot be changed by any parameters.

---

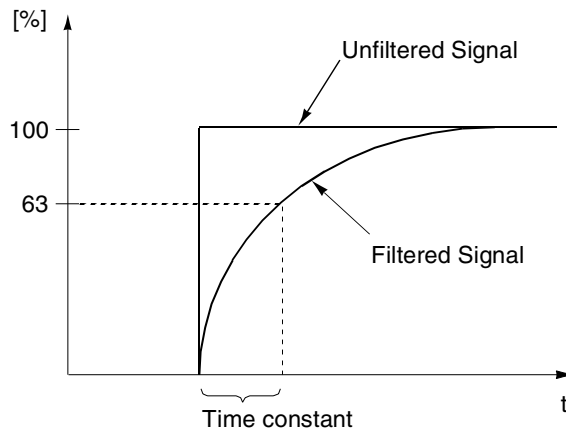

Figure 6-3 Filter time constant for analogue input AI1.

**13.05 INVERT AI1 NO;YES**

If this parameter is set to YES, the maximum value of the analogue input signal corresponds to minimum reference and the minimum value of the analogue input signal corresponds to maximum reference.

**13.06 MINIMUM AI2 0 mA; 4 mA; TUNED VALUE; TUNE**

This parameter sets the minimum value of the signal to be applied to analogue input AI2. If AI2 is selected as the signal source for external reference 1 (Par. 11.03 EXT REF1 SELECT) or external reference 2 (Par. 11.06 EXT REF2 SELECT), this value will correspond to the reference set by Parameter 11.04 EXT REF1 MINIMUM or 11.07 EXT REF2 MINIMUM. Typical minimum values are 0 mA or 4 mA.

To tune the minimum value according to the analogue input signal, press **ENTER**, select TUNE, apply the minimum analogue input signal and press **ENTER** again. The value is now set as the minimum. The readable range in tuning is 0 mA to 20 mA. The text TUNED VALUE is displayed after the TUNE operation.

The ACS 600 has a “floating zero” function which allows the protection and supervision circuitry to detect a loss of signal. To enable this feature, the minimum input signal must be greater than 1 mA.

**13.07 MAXIMUM AI2 20 mA; TUNED VALUE; TUNE**

This parameter sets the maximum value of the signal to be applied to AI2. If AI2 is selected as the signal source for external reference 1 (Parameter 11.03 EXT REF1 SELECT) or external reference 2 (Parameter 11.06 EXT REF2 SELECT), this value will correspond to the reference defined by Parameter 11.05 EXT REF1 MAXIMUM or 11.08 EXT REF2 MAXIMUM. A typical maximum value is 20 mA.

To tune the maximum value according to the analogue input signal, press **ENTER**, select TUNE, apply the maximum analogue input signal and press **ENTER** again. The value is now set as the maximum. The readable range in tuning is 0 mA to 20 mA. The text TUNED VALUE is displayed after TUNE operation.

13.08 SCALE AI2 Refer to Parameter 13.03 SCALE AI1.

13.09 FILTER AI2 Refer to Parameter 13.04 FILTER AI1.

13.10 INVERT AI2 Refer to Parameter 13.05 INVERT AI1.

13.11 MINIMUM AI3 Refer to Parameter 13.06 MINIMUM AI2.

13.12 MAXIMUM AI3 Refer to Parameter 13.07 MAXIMUM AI2.

13.13 SCALE AI3 Refer to Parameter 13.03 SCALE AI1.

13.14 FILTER AI3 Refer to Parameter 13.04 FILTER AI1.

13.15 INVERT AI3 Refer to Parameter 13.05 INVERT AI1.

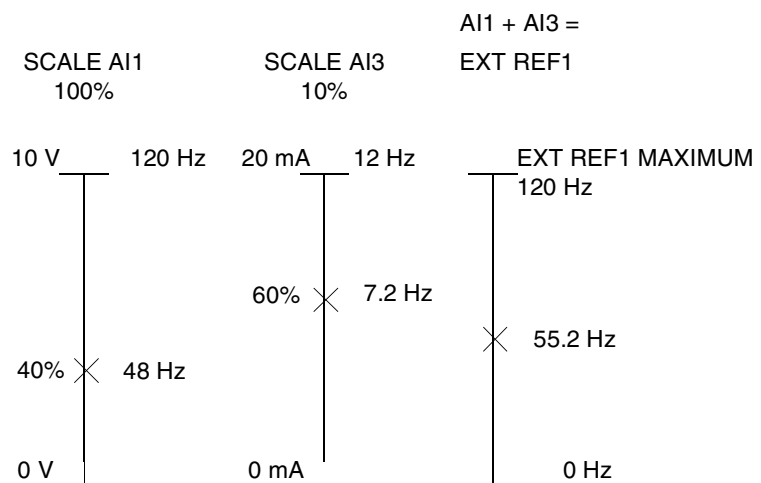

Figure 6-4 Example of scaling of analogue inputs. External reference 1 has been selected by Parameter 11.03 EXT REF1 SELECT as AI1 + AI3 and the maximum value for it (120 Hz) by Parameter 11.05 EXT REF1 MAXIMUM. The scale for analogue input AI1 is set to 100% by Parameter 13.03 SCALE AI1. The scale for analogue input AI3 is set to 10% by Parameter 13.13 SCALE AI3.

**Group 14 RELAY OUTPUTS**

The text following [Table 6-6](#) below explains the parameters in detail.

*Table 6-6 Group 14.*

Parameter	Range/Unit	Description
14.01 RELAY RO1 OUTPUT	Refer to the text below for the available selections.	Relay output 1 content.
14.02 RELAY RO2 OUTPUT		Relay output 2 content.
14.03 RELAY RO3 OUTPUT		Relay output 3 content.
14.04 EXT 2 REL OUTPUT1		Extension module 2 relay output 1
14.05 EXT 2 REL OUTPUT2		Extension module 2 relay output 2

**14.01 RELAY RO1 OUTPUT**

This parameter allows you to select which information is indicated with relay output RO1.

**M1 START**

Should be selected only if the Pump and Fan Control (PFC) Macro is active. Relay is energised when the PFC logic switches on motor 1. Relay is de-energised when the PFC logic switches off motor 1.

---

**Note:** The parameter always has the value **M1 START** if either of the following conditions is valid:

- In external control: External reference 2 is active and Parameter [81.18 AUTOCHANGE INTERVAL](#) is greater than zero.
- In local control: Parameter [11.01 KEYPAD REF SEL](#) is REF2 (%) and Parameter [81.18 AUTOCHANGE INTERVAL](#) is greater than zero.

---

**NOT USED**

**READY**

The ACS 600 is ready to function. The relay is energised unless no Run enable signal is present or a fault exists.

**RUNNING**

The ACS 600 has been started, Run enable signal is active, and no active faults exist.

**FAULT**

A fault has occurred. Refer to [Chapter 7 – Fault Tracing](#) for more details.

**FAULT (-1)**

Relay energised when power is applied, and de-energised upon a fault trip.

**FAULT(RST)**

The ACS 600 is in a fault condition, but will reset after the programmed autoreset delay (refer to Parameter [31.03 DELAY TIME](#)).

**STALL WARN**

Stall alarm has been activated (refer to Parameter [30.10 STALL FUNCTION](#)).

**STALL FLT**

Stall protection has tripped (refer to Parameter [30.10 STALL FUNCTION](#)).

**MOT TEMP WRN**

Motor temperature has exceeded the warning level.

**MOT TEMP FLT**

Motor thermal protection has tripped.

**ACS TEMP WRN**

The ACS 600 temperature has exceeded the warning level 115 °C (239 °F).

**ACS TEMP FLT**

The ACS 600 overheat protection has tripped. The tripping level is 125 °C (257 °F).

**FAULT/WARN**

Any fault or warning has occurred.

**WARNING**

Any warning has occurred.

**REVERSED**

Motor rotates in reverse direction.

**EXT CTRL**

External control is selected.

**REF2 SEL**

Reference 2 is selected.

**DC OVERVOLT**

The intermediate circuit DC voltage has exceeded the overvoltage limit.

**DC UNDERVOL**

The intermediate circuit DC voltage has fallen below the undervoltage limit.

**FREQ 1 LIM**

Output speed has exceeded or fallen below supervision limit 1. Refer to Parameter [32.01 FREQ 1 FUNCTION](#) and Parameter [32.02 FREQ 1 LIMIT](#).

**FREQ 2 LIM**

Output speed has exceeded or fallen below supervision limit 2. Refer to Parameter [32.03 FREQ 2 FUNCTION](#) and Parameter [32.04 FREQ 2 LIMIT](#).

**CURRENT LIM**

Motor current has exceeded or fallen below the set current supervision limit. Refer to Parameter [32.05 CURRENT FUNCTION](#) and Parameter [32.06 CURRENT LIMIT](#).

**REF 1 LIM**

Reference 1 has exceeded or fallen below the set supervision limit. Refer to Parameter [32.07 REF1 FUNCTION](#) and Parameter [32.08 REF1 LIMIT](#).

**REF 2 LIM**

Reference 2 has exceeded or fallen below the set supervision limit. Refer to Parameter [32.09 REF2 FUNCTION](#) and Parameter [32.10 REF2 LIMIT](#).

**STARTED**

The ACS 600 has received a Start command.

**LOSS OF REF**

Reference has been lost.

**AT SPEED**

The actual value has reached the reference value. The speed error is max. 10% of the nominal speed in speed control mode.

**ACT 1 LIM**

Actual value 1 has exceeded or fallen below the set supervision limit. Refer to Parameter [32.11 ACT1 FUNCTION](#) and [32.12 ACT1 LIMIT](#).

**ACT 2 LIM**

Actual value 2 has exceeded or fallen below the set supervision limit. Refer to Parameter [32.13 ACT2 FUNCTION](#) and [32.14 ACT2 LIMIT](#).

**COMM. MODULE**

The relay is controlled by Fieldbus reference REF3.  
See [Appendix C – Fieldbus Control](#).

**INLET LOW**

Pressure at the pump/fan inlet has fallen below the set supervision limit (and remained so longer than the set delay time). Refer to Parameter [Group 82 PRESSURE CONTROL](#).

**OUTLET HIGH**

Pressure at the pump/fan outlet has exceeded the set supervision limit (and remained so longer than the set delay time). Refer to Parameter [Group 82 PRESSURE CONTROL](#).

**PROFILE HIGH**

The signals APPL BLOCK OUTPUT or CONTROL DEVIATION has remained above the set supervision limit longer than the set delay time. Refer to Parameter [Group 82 PRESSURE CONTROL](#).



**14.02 RELAY RO2  
OUTPUT**

Refer to Parameter [14.01 RELAY RO1 OUTPUT](#). Exception: Selection **M1 START** is replaced with **M2 START**.

**M2 START**

Should be selected only if the PFC Macro is active. Relay is energised when the PFC logic switches on motor 2. Relay is de-energised when the PFC logic switches off motor 2.

---

**Note:** The parameter always has the value **M2 START** if either of the following conditions is valid:

- In external control: External reference 2 is active, parameter [81.18 AUTOCHANGE INTERVAL](#) is greater than zero and Parameter [81.17 NBR OF AUX MOTORS](#) is greater or equal than 1.
- In local control: Parameter [11.01 KEYPAD REF SEL](#) is REF2 (%), parameter [81.18 AUTOCHANGE INTERVAL](#) is greater than zero and Parameter [81.17 NBR OF AUX MOTORS](#) is greater or equal than 1.

**14.03 RELAY RO3  
OUTPUT**

Refer to Parameter [14.01 RELAY RO1 OUTPUT](#). Exceptions: Selection **M1 START** is replaced with **M3 START**, ACT1 LIM with MAGN READY, and ACT2 LIM with USER 2 SEL

**M3 START**

Should be selected only if the PFC Macro is active. Relay is energised when the PFC logic switches on motor 3. Relay is de-energised when the PFC logic switches off motor 3.

---

**Note:** The parameter always has the value **M3 START** if either of the following conditions is valid:

- In external control: External reference 2 is active, parameter [81.18 AUTOCHANGE INTERVAL](#) is greater than zero and Parameter [81.17 NBR OF AUX MOTORS](#) is greater or equal than 2.
- In local control: Parameter [11.01 KEYPAD REF SEL](#) is REF2 (%), parameter [81.18 AUTOCHANGE INTERVAL](#) is greater than zero and Parameter [81.17 NBR OF AUX MOTORS](#) is greater or equal than 2.

**MAGN READY**

The motor is magnetised and ready to give nominal torque (nominal magnetising of the motor has been reached).

**USER 2 SEL**

User Macro 2 has been loaded.

**14.04 EXT 2 REL OUTPUT 1** This parameter allows you to select which information is indicated with extension module 2 relay output 1.

**READY; RUNNING; FAULT; FAULT (-1); SPEED 1 LIM; ACT1 LIM; INLET LOW; OUTLET HIGH; PROFILE HIGH**

Refer to Parameter [14.01 RELAY RO1 OUTPUT](#) for details on these selections.

**14.05 EXT 2 REL OUTPUT 2** This parameter allows you to select which information is indicated with extension module 2 relay output 2.

---

**Note:** This parameter also selects the information sent to PFC extension module relay output 2 unless Parameter [81.17 NBR OF AUX MOTORS](#) is set to FOUR. In that case, PFC extension module relay output 2 is used to control the fourth auxiliary motor.

---

**READY; RUNNING; FAULT; FAULT (-1); FREQ 2 LIM; ACT2 LIM; INLET LOW; OUTLET HIGH; PROFILE HIGH**

Refer to Parameter [14.01 RELAY RO1 OUTPUT](#) for details on these selections.

**Group 15 ANALOGUE  
OUTPUTS**

The Range/Unit column in [Table 6-7](#) below shows the allowable parameter values. The text following the table explains the parameters in detail.

*Table 6-7 Group 15.*

Parameter	Range/Unit	Description
15.01 ANALOGUE OUTPUT 1	Refer to the text below for the available selections.	Analogue output 1 content.
15.02 INVERT AO1	NO; YES	Analogue output signal 1 inversion.
15.03 MINIMUM AO1	0 mA; 4 mA	Analogue output signal 1 minimum.
15.04 FILTER AO1	0.00 ... 10.00 s	Filter time constant for AO1.
15.05 SCALE AO1	10 ... 1000%	Analogue output signal 1 scaling factor.
15.06 ANALOGUE OUTPUT 2	Refer to the text below for the available selections.	Analogue output 2 content.
15.07 INVERT AO2	NO; YES	Analogue output signal 2 inversion.
15.08 MINIMUM AO2	0 mA; 4 mA	Analogue output signal 2 minimum.
15.09 FILTER AO2	0.00 ... 10.00 s	Filter time constant for AO2.
15.10 SCALE AO2	10 ... 1000%	Analogue output signal 2 scaling factor.

**15.01 ANALOGUE  
OUTPUT1**

This parameter allows you to select which output signal is connected to analogue output AO1 (current signal). The following list shows the full scale value with Parameters [15.05 SCALE AO1](#) and [15.10 SCALE AO2](#) set to 100%.

**NOT USED****SPEED**

Motor speed. 20 mA = motor nominal speed. The updating interval is 24 ms.

**FREQUENCY**

Output frequency. 20 mA = motor nominal frequency. The updating interval is 24 ms.

**CURRENT**

Output current. 20 mA = motor nominal current. The updating interval is 24 ms.

**TORQUE**

Motor torque. 20 mA = 100% of motor nominal rating. The updating interval is 24 ms.

**POWER**

Motor power. 20 mA = 100% of motor nominal rating. The updating interval is 100 ms.

**DC BUS VOLT**

DC bus voltage. 20 mA = 100% of the reference value. The reference value is 540 V d.c. ( $= 1.35 \times 400$  V) for ACS 600 with 380 ... 415 V a.c. mains voltage rating and 675 V d.c. ( $1.35 \times 500$  V) for ACS 600 with 380 ... 500 V a.c. mains voltage rating. The updating interval is 24 ms.

**OUTPUT VOLT**

Motor voltage. 20 mA = motor rated voltage. The updating interval is 100 ms.

**REFERENCE**

Active reference that the ACS 600 is currently following. 20 mA = 100% of the active reference. The updating interval is 24 ms.

**CONTROL DEV**

The difference between the reference and the actual value of the PFC PI Controller. 0/4 mA = -100% , 10/12 mA = 0%, 20 mA = 100%. The updating interval is 24 ms.

**ACTUAL 1**

Value scaled by Parameter [80.07 ACT1 MINIMUM](#) and [80.08 ACT1 MAXIMUM](#). 20 mA = value of Parameter [80.08 ACT1 MAXIMUM](#). The updating interval is 24 ms.

**ACTUAL 2**

Value scaled by Parameter [80.09 ACT2 MINIMUM](#) and [80.10 ACT2 MAXIMUM](#). 20 mA = value of Parameter [80.10 ACT2 MAXIMUM](#). The updating interval is 24 ms.

**PICON OUTP**

The reference, which is given as output from the PFC-application control block. The updating interval is 24 ms.

**PICON REF**

Reference to the PI control block. The updating interval is 24 ms.

**ACTUAL FUNC**

Result of an arithmetical operation selected by Parameter [80.04 ACTUAL VALUE SEL](#) and scaled by Parameter [80.15 ACTUAL FUNC SCALE](#). The updating interval is 24 ms.

**COMM. MODULE**

The value is read from Fieldbus reference REF4. See [Appendix C – Fieldbus Control](#).

15.02 INVERT AO1    Selecting YES inverts the analogue output AO1 signal.

**15.03 MINIMUM AO1** The minimum value of the analogue output signal can be set to either 0 mA or 4 mA.

**15.04 FILTER AO1** Filter time constant for analogue output AO1.

As the analogue output value changes, 63% of the change takes place within the time period specified by this parameter (See [Figure 6-3](#)).

---

**Note:** Even if you select 0 s as the minimum value, the signal is still filtered with a time constant of 10 ms due to the signal interface hardware. This cannot be changed by any parameters.

---

**15.05 SCALE AO1** This parameter is the scaling factor for the analogue output AO1 signal. If the selected value is 100%, the nominal value of the output signal corresponds to 20 mA. If the maximum is less than full scale, increase the value of this parameter.

**Example:** The nominal motor current is 7.5 A and the measured maximum current at maximum load is 5 A. The motor current of 0 to 5 A is read as a 0 to 20 mA analogue signal through AO1.

1. AO1 is set to CURRENT with Parameter 15.01.
2. AO1 minimum is set to 0 mA with Parameter 15.03.
3. The measured maximum motor current is scaled to correspond to 20 mA analogue output signal: The reference value of the output signal CURRENT is the motor nominal current, i.e. 7.5 A (see Parameter 15.01). With 100 % scaling, the reference value corresponds to full scale output signal 20 mA. To make the measured maximum motor current correspond to 20 mA, it should be scaled equal to the reference value before it is converted to an analogue output signal.

$$k \times 5 \text{ A} = 7.5 \text{ A} \Rightarrow k = 1.5 = 150\%$$

Thus the scaling factor is set to 150%.

**15.06 ANALOGUE OUTPUT2** Refer to Parameter 15.01.

**15.07 INVERT AO2** Refer to Parameter 15.02.

**15.08 MINIMUM AO2** Refer to Parameter 15.03.

**15.09 FILTER AO2** Refer to Parameter 15.04.

**15.10 SCALE AO2** Refer to Parameter 15.05.

**Group 16 SYSTEM CTR INPUTS**

The Range/Unit column in [Table 6-8](#) below shows the allowable parameter values. The text following the table explains the parameters in detail.

*Table 6-8 Group 16.*

Parameter	Range/Unit	Description
16.01 RUN ENABLE	YES; DI1 ... DI6; COMM. MODULE	Run enable input.
16.02 PARAMETER LOCK	OPEN; LOCKED;	Parameter lock input.
16.03 PASS CODE	0 ... 30000	Parameter lock pass code.
16.04 FAULT RESET SEL	NOT SEL; DI1 ... DI6; ON STOP; COMM. MODULE	Fault reset input.
16.05 USER MACRO IO CHG	NOT SEL; DI1 ... DI6	Restores parameters to user macro setting values.
16.06 LOCAL LOCK	OFF; ON	Disables local control (Panel)
16.07 PARAM SAVE	SAVE..; DONE	Parameter saving to the permanent memory

**16.01 RUN ENABLE**

This parameter selects the source of the run enable signal.

Indication of missing Run Enable signal is shown on the first row of the Control Panel display (see [Chapter 2 – Overview of ACS 600 Programming and the CDP 312 Control Panel](#)).

**YES**

Run enable signal is active. The ACS 600 is ready to start without an external run enable signal.

**DI1 ... DI6**

To activate the Run Enable signal, the selected digital input must be connected to +24 V DC. If the voltage drops to 0 V DC, the ACS 600 will coast to stop and will not start until the Run enable signal resumes.

**COMM. MODULE**

The signal is given through a communication (e.g. fieldbus adapter) module. See [Appendix C – Fieldbus Control](#).

**16.02 PARAMETER LOCK**

This parameter selects the state of the Parameter Lock. With Parameter Lock you can inhibit unauthorised parameter changes.

**OPEN**

Parameter Lock is open. Parameters can be altered.

**LOCKED**

Parameter Lock is closed from the Control Panel. Parameters cannot be altered. The Parameter Lock can be opened only by entering the valid code at Parameter [16.03 PASS CODE](#).

**16.03 PASS CODE**

This parameter selects the Pass Code for the Parameter Lock. The default value of this parameter is 0. In order to open the Parameter Lock, change the value to 358. After the Parameter Lock is opened the value is automatically changed back to 0.

**16.04 FAULT RESET SEL****NOT SEL**

Fault reset is executed from the Control Panel keypad only.

**DI1 ... DI6**

Fault reset is executed through the digital input, or from the Control Panel:

- Control Panel in remote mode: Reset is activated by a rising (positive) edge of the digital input signal, i.e. by closing a normally open contact, connecting 24 VDC to the digital input terminal.
- Control Panel in local mode: Reset is activated by the Control Panel reset key.

**ON STOP**

Fault reset is executed along with the stop signal received through a digital input. Reset can be given from the Control Panel also.

**COMM. MODULE**

The signal is given through fieldbus Control Word. See [Appendix C – Fieldbus Control](#). Reset can be given from the Control Panel also.

**16.05 USER MACRO IO CHG****NOT SEL; DI1 ... DI6**

This parameter enables the selection of the desired User Macro via a digital input in the following way:

When the state of the specified digital input changes from high to low User Macro 1 is loaded. When the state of the specified digital input changes from low to high User Macro 2 is loaded.

The User Macro used can be changed via a digital input only when the drive is stopped. During the change of the Macro the drive will not start.

The value of this parameter is not included in the User Macro. The setting once made remains despite of the User Macro change.

User Macro 2 selection can be supervised via relay output 3. See Parameter [14.03 RELAY RO3 OUTPUT](#) for more information.

---

**Note:** Always redo the User Macro save by Parameter [99.02 APPLICATION MACRO](#) after changing parameter settings or reperforming the motor identification. If Parameter [16.05 USER MACRO IO CHG](#) is pointing to a digital input, the last settings saved by the user are loaded into use whenever the power is switched off and on again, or macro is changed. Any unsaved changes will be lost.

---

16.06 LOCAL LOCK

**OFF; ON**

Selection ON disables local control (Panel) after which the control signals (Start, Stop, Direction, Reference) cannot be given from panel.

LOC/REM key of the Control Panel cannot be used for restoring the local control while ON is selected.

---



**WARNING:** Before activating this function it must be ensured that the Control Panel is not needed for stopping the drive.

---

16.07 PARAM SAVE

**SAVE..; DONE**

Selection SAVE saves parameter values to the permanent memory.

---

**Note:** A new parameter value of a standard macro is saved automatically when changed from the Panel but not when altered through a fieldbus connection.

---



**Group 20 LIMITS**

The Range/Unit column in [Table 6-9](#) below shows the allowable parameter values. The text following the table explains the parameters in detail.

*Table 6-9 Group 20.*

Parameter	Range/Unit	Description
20.01 MINIMUM FREQ	-120.00 ... 120.00 Hz	Operating range minimum frequency.
20.02 MAXIMUM FREQ	-120.00 ... 120.00 Hz	Operating range maximum frequency
20.03 MAXIMUM CURRENT	0% $I_{hd}$ ...200% $I_{hd}$	Maximum output current.
20.04 MAXIMUM TORQUE	0% ... 300%	Maximum output torque. Cannot be used in the SCALAR mode.
20.05 OVERVOLTAGE CTRL	ON; OFF	DC overvoltage controller
20.06 UNDERVOLTAGE CTRL	ON; OFF	DC undervoltage controller
20.11 P MOTORING LIM	0% ... 600%	Limit for the maximum power from inverter to motor.
20.12 P GENERATING LIM	-600% ... 0%	Limit for the maximum power from motor to inverter.

**20.01 MINIMUM FREQUENCY**

Represents the minimum frequency. The default value depends on the selected motor. When the value is positive the motor will not run in the reverse direction. With the PFC Macro, negative values must not be used.

**20.02 MAXIMUM FREQUENCY**

Represents the maximum frequency. The default value depends on the selected motor. With the PFC Macro, negative values must not be used.

**20.03 MAXIMUM CURRENT**

The maximum output current that the ACS 600 will supply to the motor. The default value is 200%  $I_{hd}$  e.g. 200 percentage of the heavy-duty use output current of the ACS 600.

**20.04 MAXIMUM TORQUE**

This setting defines the momentarily allowed maximum torque of the motor. The motor control software of the ACS 600 limits the setting range of the maximum torque according to the inverter and motor data. The default value is 300% of the nominal torque of the motor.

This limit cannot be set in the scalar control mode.

**20.05 OVERVOLTAGE  
CTRL**

Selection **OFF** deactivates the overvoltage controller.

Fast braking of a high inertia load causes the DC bus voltage to rise to the overvoltage control limit. To prevent the DC voltage from exceeding the limit, the overvoltage controller automatically decreases the braking torque.

---

**CAUTION!** If a braking chopper and a braking resistor are connected to the ACS 600, this parameter must be set to OFF to ensure proper operation of the chopper.

---

**20.06 UNDERVOLTAGE  
CTRL**

Selection **OFF** deactivates the undervoltage controller.

If the DC bus voltage drops due to loss of input power, the undervoltage controller will decrease the motor speed in order to keep the DC bus voltage above the lower limit. By decreasing the motor speed, the inertia of the load will cause regeneration back into the ACS 600, keeping the DC bus charged, and preventing an undervoltage trip. This will increase power loss ride-through on systems with a high inertia, such as a centrifuge or fan.

**20.11 P MOTORING LIM**

Defines the maximum allowed power fed by the inverter to the motor.

**0% ... 600%**

Maximum motoring power limit in percent of motor nominal power.  
Default: 300%.

**20.12 P GENERATING  
LIM**

Defines the maximum allowed power fed by the motor to the inverter.

**-600% ... 0%**

Maximum generating power limit in percent of motor nominal power.  
Default: -300%.

**Group 21 START/STOP** The Range/Unit column in [Table 6-10](#) below shows the allowable parameter values. The text following the table explains the parameters in detail.

Table 6-10 Group 21.

Parameter	Range/Unit	Description
21.01 START FUNCTION	AUTO; DC MAGN; CNST DC MAGN	Start function selection.
21.02 CONST MAGN TIME	30.0 ... 10000.0 ms	Time for pre-magnetising.
21.03 STOP FUNCTION	COAST; RAMP;	Stop function selection.
21.08 SCALAR FLYSTART	OFF; ON	Activation of flying start feature in scalar control mode.

### 21.01 START FUNCTION

#### **AUTOMATIC**

Automatic start is the default start function. This selection guarantees optimal motor starting in most cases. It includes the flying start (starting to a rotating machine) and the automatic restart functions (stopped motor can be restarted immediately without waiting the motor flux to die away).

The ACS 600 motor control identifies the flux as well as the mechanical state of the motor and starts the motor instantly under all conditions.

AUTOMATIC is always to be selected when in the scalar control mode (see Parameter [99.04 MOTOR CTRL MODE](#)), although in scalar control no flying start or automatic restart is possible.

#### **DC MAGN**

DC magnetising should be selected if high breakaway torque is required. The ACS 600 pre-magnetises the motor before the start. The pre-magnetising time is determined automatically, being typically 200 ms to 2 s depending on the motor size. This selection guarantees the highest possible break-away torque.

The starting to a rotating machine is not possible when DC magnetising is selected. DC magnetising cannot be selected in the scalar control mode (see Parameter [99.04 MOTOR CTRL MODE](#)).

#### **CNST DC MAGN**

Constant DC magnetising should be selected instead of DC magnetising if constant pre-magnetising time is required (e.g. if the motor start must be simultaneous with a mechanical brake release). This selection also guarantees the highest possible break-away torque when the pre-magnetising time is set long enough. The pre-magnetising time is defined by Parameter [21.02 CONST MAGN TIME](#).

Starting to a rotating machine is not possible when DC magnetising is selected. DC magnetising cannot be selected in the scalar control mode (see Parameter [99.04 MOTOR CTRL MODE](#)).

**21.02 CONST MAGN TIME** Defines the magnetising time in the constant magnetising mode (see Parameter [21.01 START FUNCTION](#)).

**21.03 STOP FUNCTION**

**COAST**

The ACS 600 stops supplying voltage immediately after a Stop command is received and the motor coasts to a stop.

**RAMP**

Ramp deceleration, as defined by the active deceleration time, Parameter [22.03 DECEL TIME 1](#) or Parameter [22.05 DECEL TIME 2](#). Motor voltage is gradually decreased to zero.



---

**WARNING:** If the Autochange function of the PFC macro is used, Parameter [21.03 STOP FUNCTION](#) must be set to COAST (see Parameter [81.18 AUTOCHANGE INTERVAL](#)).

---

**21.08 SCALAR FLYSTART**

Activates the flying start feature in the scalar control mode. See Parameter [21.01 START FUNCTION](#) for the flying start feature and Parameter [99.04 MOTOR CTRL MODE](#) for the scalar control mode.

**OFF**

The flying start feature is not active in the scalar control mode. This is the default setting.

**ON**

The flying start feature is active in the scalar control mode.

**Group 22  
ACCEL/DECEL**

The Range/Unit column in [Table 6-11](#) below shows the allowable parameter values. The text following the table explains the parameters in detail.

*Table 6-11 Group 22.*

Parameter	Range/Unit	Description
22.01 ACC/DEC 1/2 SEL	ACC/DEC 1; ACC/DEC 2; DI1 ... DI6	Acceleration/Deceleration ramp selection.
22.02 ACCEL TIME 1	0.00 ... 1800.00 s	Time for 0 frequency to max. frequency (Acceleration ramp 1).
22.03 DECEL TIME 1	0.00 ... 1800.00 s	Time for max. frequency to 0 frequency (Deceleration ramp 1).
22.04 ACCEL TIME 2	0.00 ... 1800.00 s	Time for 0 frequency to max. frequency (Acceleration ramp 2).
22.05 DECEL TIME 2	0.00 ... 1800.00 s	Time for max frequency to 0 frequency (Deceleration ramp 2).
22.06 ACC/DEC RAMP SHPE	0 ... 1000.00 s	Accel./Decel. ramp shape time.
22.07 EM STOP RAMP TIME	0.00 ... 2000.00 s	Emergency Stop decel.ramp time.

**22.01 ACC/DEC 1/2 SEL**

This parameter selects the Acceleration/Deceleration Ramp pair that is used. The selection can be performed through digital inputs DI1 to DI6. 0 V DC = Acceleration ramp 1 and Deceleration ramp 1 are used; 24 V DC = Acceleration ramp 2 and Deceleration ramp 2 are used.

**22.02 ACCEL TIME 1**

The time required for the frequency to change from 0 to the maximum frequency. The maximum frequency is defined with Parameter [20.02 MAXIMUM FREQUENCY](#), or [20.01 MINIMUM FREQUENCY](#) if the absolute value of the minimum limit is greater than the maximum limit.

If the reference signal changes at a rate slower than the acceleration time, the motor frequency will follow the reference signal. If the reference signal changes faster than the acceleration time, the rate at which the motor speeds up will be limited by this parameter.

If acceleration time is set too short, the ACS 600 will automatically prolong the acceleration not to exceed the maximum current limit (Parameter [20.03 MAXIMUM CURRENT](#)).

**22.03 DECEL TIME 1**

The time required for the frequency to change from maximum to zero. The maximum frequency is defined with Parameter [20.02 MAXIMUM FREQUENCY](#), or [20.01 MINIMUM FREQUENCY](#), if the absolute value of the minimum limit is greater than the maximum limit.

If the reference signal changes at a rate slower than the deceleration time, the motor frequency will follow the reference signal. If the

reference signal changes faster than the deceleration time, the rate at which the motor slows down will be limited by this parameter.

If deceleration time is set too short, the ACS 600 will automatically prolong the deceleration not to exceed the DC bus overvoltage limit. If there is any doubt about the deceleration time being too short, ensure that the DC overvoltage control is on (Parameter [20.05 OVERVOLTAGE CTRL](#)).

If short deceleration time is needed for the high inertia application, the ACS 600 should be equipped with a braking chopper and a braking resistor. The excess energy generated during the braking is led by the chopper to the resistor and dissipated to prevent a DC voltage rise in the intermediate circuit. The chopper and the resistor are available for all ACS 600 types as optional add-on kits.

**22.04 ACCEL TIME 2** Refer to Parameter [22.02 ACCEL TIME 1](#).

**22.05 DECEL TIME 2** Refer to Parameter [22.03 DECEL TIME 1](#).

**22.06 ACC/DEC RAMP SHPE** This parameter allows you to select the shape of the acceleration/deceleration ramp.

**0 s**  
Linear ramp. Suitable for drives requiring steady acceleration or deceleration and for slow ramps.

**0.100 ... 1000.00 s**  
S-curve ramp. S-curve ramps are ideal for conveyors carrying fragile loads, or other applications where a smooth transition is required when changing from one speed to another. The S-curve consists of symmetrical curves at both ends of the ramp and a linear part in between.

As a rule of thumb, a suitable relation between the ramp shape time and the acceleration ramp time is 1/5. Examples are given below.

Acc/Dec Ramp Time (Par. 22.02 to 22.05)	Ramp Shape Time (Par. 22.06)
1 s	0.2 s
5 s	1 s
15 s	3 s

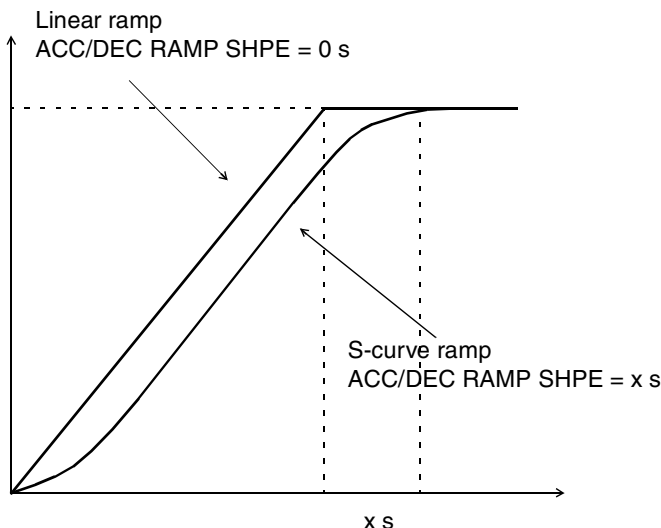

Figure 6-5 Acceleration and deceleration ramp shapes.

**22.07 EM STOP  
RAMP TIME**

This parameter defines the time inside which the drive is stopped upon an Emergency Stop command. The command can be given through a communication (e.g. fieldbus adapter) module (optional).

**0.00 ... 2000.00 s**



---

**WARNING:** If the Autochange function of the PFC Macro is used, a Ramp stop is not allowed (see Parameters [21.03 STOP FUNCTION](#) and [81.18 AUTOCHANGE INTERVAL](#)).

---

**Group 23 SPEED CTRL**

The Range/Unit column in [Table 6-12](#) below shows the allowable parameter values. The text following the table explains the parameters in detail.

These parameters are not visible in the scalar control mode.

*Table 6-12 Group 23.*

Parameter	Range/Unit	Description
23.01 GAIN	0.0 ... 100.0	Gain for speed controller.
23.02 INTEGRATION TIME	0.01 s ... 999.98 s	Integration time for speed controller.
23.03 SLIP GAIN	0.0% ... 400.0%	Gain for the slip of the motor.

It is possible to tune the PI algorithm based speed controller of the ACS 600 by setting Parameters [23.01 GAIN](#) to [23.03 SLIP GAIN](#) in this group. The Motor ID Run automatically tunes the speed controller so it is not necessary to tune it separately.

The values of these parameters define how the output of the Speed Controller changes when there is a difference (error value) between the actual speed and the reference. [Figure 6-6](#) displays typical step responses of the Speed Controller.

Step responses can be seen by monitoring Actual Signal 2 SPEED.

**Note:** The Standard Motor ID Run (refer to [Chapter 3 – Start-up Data](#)) updates the values of Parameters [23.01 GAIN](#) and [23.02 INTEGRATION TIME](#).

The dynamic performance of the speed control at low speeds can be improved by increasing the relative gain and decreasing the integration time.

Speed controller output is the reference for the torque controller. The torque reference is limited by Parameter [20.04 MAXIMUM TORQUE](#).

**Note:** Refer also to [Group 80 PI CONTROL](#) for the directions for tuning the process PI controller.



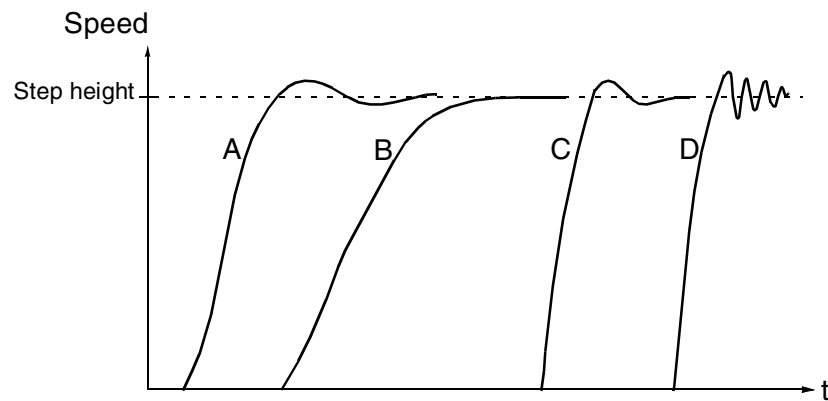

- A : Undercompensated: 23.02 INTEGRATION TIME too short and 23.01 GAIN too low
- B : Normally tuned, autotuning
- C : Normally tuned, manual tuning. Better dynamic performance than with B
- D : Overcompensated: 23.02 INTEGRATION TIME too short and 23.01 GAIN too high

Figure 6-6 Step responses of the Speed Controller with different settings. 1 to 10% reference step is used.

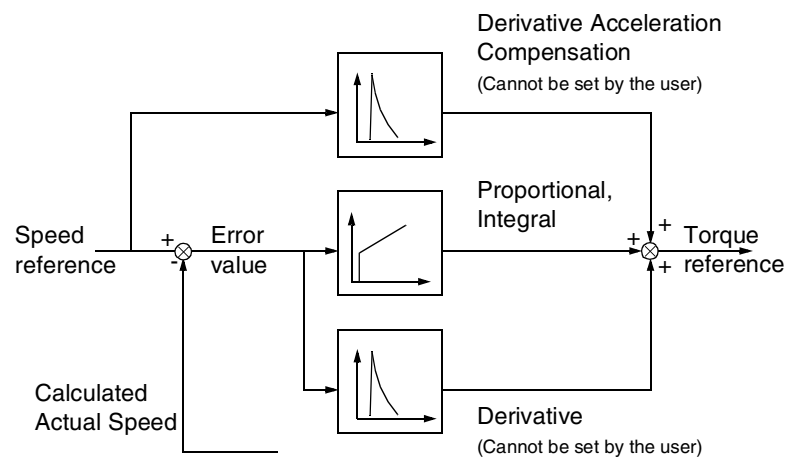

Figure 6-7 Speed controller, a simplified block diagram.

**23.01 GAIN** Relative gain for the speed controller. If you select 1, a 10% change in error value (e.g. reference - actual value) causes the speed controller output to change 10% of the nominal torque.

**Note:** Great gain may cause speed oscillation.

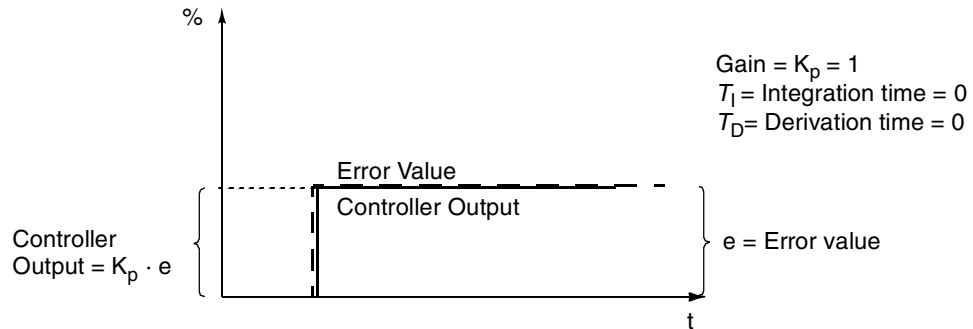

Figure 6-8 Speed Controller Output after an error step when the error remains constant.

**23.02 INTEGRATION TIME** Integration time defines the rate at which the controller output changes when the error value is constant. The shorter the integration time, the faster the continuous error value is corrected. Too short an integration time makes the control unstable.

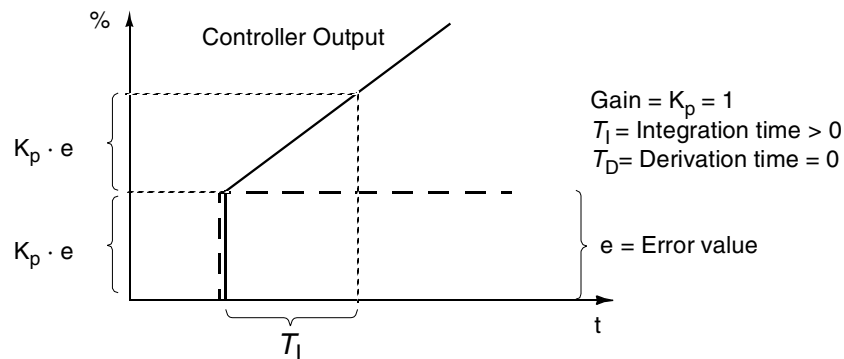

Figure 6-9 Speed Controller Output after an error step when the error remains constant.

**23.03 SLIP GAIN** Defines the gain for the slip. 100% means full slip compensation; 0% means no slip compensation. The default value is 100%. Other values can be used if static speed error is detected despite of the full slip compensation.

**Example:** 1000 rpm constant speed reference is given to the drive. Despite of the full slip compensation (SLIP GAIN = 100%) a manual tachometer measurement from the motor axis gives speed value 998 rpm. The static speed error is 1000 rpm - 998 rpm = 2 rpm. To compensate the error, the slip gain should be increased. At a gain value of 106% no static speed error exists.

**Group 25 CRITICAL  
FREQ**

These parameter values can be altered with the ACS 600 running. The Range/Unit column in [Table 6-13](#) below shows the allowable parameter values. The text following the table explains the parameters in detail.

*Table 6-13 Group 25.*

Parameter	Range/Unit	Description
25.01 CRIT FREQ SELECT	OFF; ON	Critical Freq. jump over logic.
25.02 CRIT FREQ 1 LOW	0...120 Hz	Critical Frequency 1 start.
25.03 CRIT FREQ 1 HIGH	0...120 Hz	Critical Frequency 1 end.
25.04 CRIT FREQ 2 LOW	0...120 Hz	Critical Frequency 2 start.
25.05 CRIT FREQ 2 HIGH	0...120 Hz	Critical Frequency 2 end.

---

**Note:** Using the critical frequency lockout function in a closed loop application will cause the system to oscillate if the required output frequency is within the critical frequency band.

---



---

**Note:** The value of the low frequency cannot be higher than the high frequency of the same band. As the low frequency is raised above the high frequency, the high frequency will rise with the low frequency.

---

In some mechanical systems, certain frequency ranges can cause resonance problems. With this Parameter Group, it is possible to set up to two different frequency ranges that the ACS 600 will skip. It is not required that Parameter [25.04 CRIT FREQ 2 LOW](#) is higher than Parameter [25.03 CRIT FREQ 1 HIGH](#) as long as the LOW parameter of any one set is lower than the HIGH parameter of the same set. Sets may overlap, but the skip will be from the lower LOW value to the higher HIGH value.

To activate the Critical Frequency settings, set Parameter [25.01 CRIT FREQ SELECT](#) to ON.

---

**Note:** Set unused Critical frequencies to 0 Hz.

---

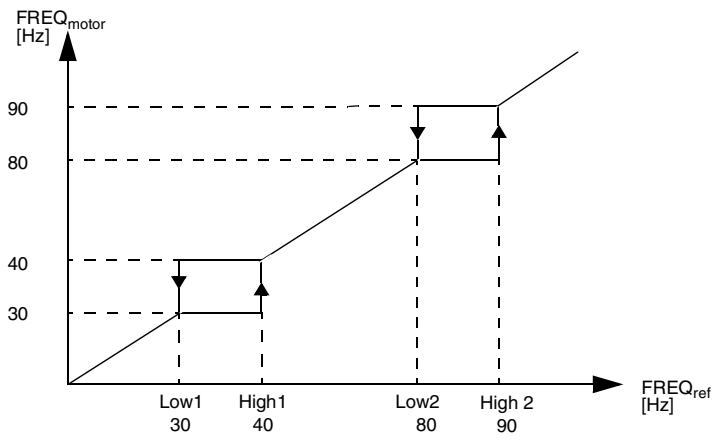

*Figure 6-10 Example: Critical Frequency settings in a fan system suffering vibration problems in the frequency ranges 30 Hz to 40 Hz and 80 Hz to 90 Hz.*

**Group 26 MOTOR CONTROL**

The Range/Unit column in Table below shows the allowable parameter values. The text following the table explains the parameters in detail.

Table 6-14 Group 26.

Parameter	Range/Unit	Description
26.01 FLUX OPTIMIZATION	NO; YES	Selection of the flux optimization function.
26.02 FLUX BRAKING	NO; YES	Selection of the flux braking function.
26.03 IR COMPENSATION	0.0 ... 30.0%	Compensation voltage level.
26.04 HEX FIELD WEAKEN	OFF; ON	Activates/inactivates motor flux control based on hexagonal flux pattern.

**26.01 FLUX OPTIMIZATION**

The total energy consumption and noise can be reduced by changing the magnitude of the flux depending on the actual load. Flux optimization should be activated in drives that usually operate below nominal load. This parameter has no effect in the scalar control mode (see Parameter [99.04 MOTOR CTRL MODE](#)).

**26.02 FLUX BRAKING**

The ACS 600 can provide faster deceleration by raising the level of magnetisation in the motor when needed, instead of limiting the deceleration ramp. By increasing the flux in the motor, the energy of the mechanical system is changed to thermal energy in the motor.

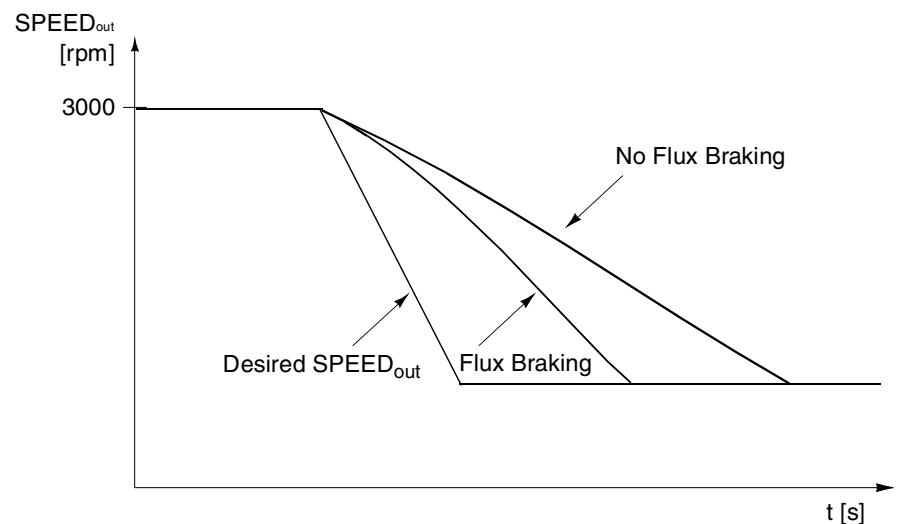

Figure 6-11 Motor deceleration with and without Flux Braking.

This parameter is visible only in the DTC motor control mode.

**26.03 IR  
COMPENSATION**

This parameter is visible in the scalar control mode only. It sets the extra relative voltage level that is given to the motor at zero speed. The range is 0 ... 30% of motor nominal voltage. IR compensation increases the breakaway torque.

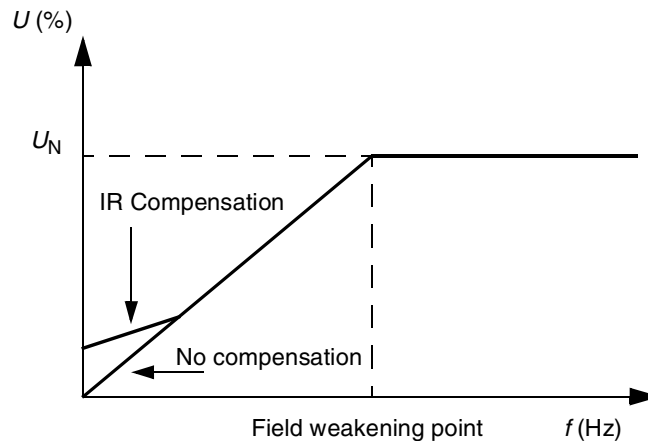

Figure 6-12 IR Compensation is implemented by applying extra voltage to the motor.  $U_N$  is the nominal voltage of the motor.

**26.04 HEX FIELD  
WEAKEN**

This parameter selects whether motor flux is controlled along a circular or a hexagonal pattern in the field weakening area of the frequency range.

**OFF**

The ACS 600 controls the motor flux such a way that the rotating flux vector follows a circular pattern. This is the default value and ideal for most applications. However, when operated in the field weakening range, it is not possible to reach 100% output voltage. The peak load capacity of the drive is lower than with full voltage.

**ON**

Motor flux is controlled along a circular pattern below the field weakening point (FWP, typically 50 or 60 Hz), and along a hexagonal pattern within the field weakening range. The applied pattern is changed gradually as the frequency increases from 100% to 120% of the FWP. Using the hexagonal flux, the maximum output voltage can be reached; the peak load capacity is higher than with the circular flux but the continuous load capacity is lower in frequency range from FWP to  $1.6 \times$  FWP due to increased losses.

**Group 30 FAULT FUNCTIONS**

The Range/Unit column in [Table 6-15](#) shows the allowable parameter values. The text following the table explains the parameters in detail.

*Table 6-15 Group 30.*

Parameter	Range/Unit	Description
30.01 AI<MIN FUNCTION	FAULT; PRESET FREQ; LAST FREQ	Operation in case of AI <Minimum fault.
30.02 PANEL LOSS	FAULT; PRESET FREQ; LAST FREQ	Operation in case the Control Panel, which is selected as active control location for the ACS 600, stops communicating.
30.03 EXTERNAL FAULT	NOT SEL; DI1-DI6	External fault input.
30.04 MOTOR THERM PROT	FAULT; WARNING; NO	Operation in case of overtemperature.
30.05 MOT THERM P MODE	DTC; USER MODE; THERMISTOR	Motor thermal protection mode selection.
30.06 MOTOR THERM TIME	256.0 ... 9999.8 s	Time for 63% temperature rise.
30.07 MOTOR LOAD CURVE	50.0 ... 150.0%	Motor current maximum limit.
30.08 ZERO SPEED LOAD	25.0 ... 150.0%	Motor load curve point at zero speed.
30.09 BREAK POINT	1.0 ... 300.0 Hz	Break point of motor load curve.
30.10 STALL FUNCTION	FAULT; WARNING; NO	Operation in case of motor stall.
30.11 STALL FREQ HI	0.5 ... 50 Hz	Frequency limit for stall protection logic.
30.12 STALL TIME	10.00 ... 400.00 s	Time for stall protection logic.
30.13 UNDERLOAD FUNC	NO; WARNING; FAULT	Operation in case of underload fault.
30.14 UNDERLOAD TIME	0.0 ... 600.0 s	Time limit for underload logic.
30.15 UNDERLOAD CURVE	1 ... 5	Torque limit for underload logic.
30.16 MOTOR PHASE LOSS	NO; FAULT	Operation in case motor phase is lost.
30.17 EARTH FAULT	NO; FAULT	Operation in case of earth fault.

Parameter	Range/Unit	Description
30.18 PRESET FREQ	0.00 ... 120.00 Hz	Preset fault frequency (See parameters <a href="#">30.01 AI&lt;MIN FUNCTION</a> , <a href="#">30.02 PANEL LOSS</a> and <a href="#">30.19 COMM FAULT FUNC</a> ).
30.19 COMM FAULT FUNC	FAULT; NO; PRESET FREQ; LAST FREQ	Operation in case DDCS communication with the communication module is lost.
30.20 MAIN REF DS T-OUT	0.1 s ... 60 s	Main Reference Data Set loss time delay for function specified by Parameter <a href="#">30.19 COMM FAULT FUNC</a> .
30.21 COMM FAULT RO/AO	ZERO; LAST VALUE	Operation of the relay output/analogue output in case DDCS communication with the communication module is lost.
30.22 AUX REF DS T-OUT	0.1 s ... 60 s	Auxiliary Reference Data Set loss time delay for function specified by Parameter <a href="#">30.19 COMM FAULT FUNC</a> .

### 30.01 AI<MIN FUNCTION

This parameter allows the selection of operation in case the analogue input (AI1, AI2 or AI3) signal drops below the minimum limit, provided the minimum is set at 0.5 V/1.0 mA or above (“floating zero”).

---

**CAUTION:** If you select PRESET FREQ or LAST FREQ, make sure that it is safe to continue operation in case analogue input signal is lost.

---

#### **FAULT**

Fault indication is displayed and the drive coasts to stop.

#### **NO**

No activity wanted.

#### **PRESET FREQ**

Warning indication is displayed and the frequency is set according to parameter [30.18 PRESET FREQ](#).

#### **LAST FREQ**

Warning indication is displayed and the frequency is set to the level the ACS 600 was last operating at. This value is determined by the average frequency over the last 10 seconds.



**30.02 PANEL LOSS** Defines the operation of the ACS 600 if the Control Panel selected as the control location for the ACS 600 stops communicating.

---

**CAUTION:** If you select PRESET FREQ or LAST FREQ, make sure that it is safe to continue operation in case analogue input signal is lost.

---

**FAULT; PRESET FREQ; LAST FREQ**

Refer to Parameter [30.01 AI<MIN FUNCTION](#).

**30.03 EXTERNAL FAULT**

**NOT SEL**

**DI1 ... DI6**

This selection defines the digital input used for an external fault signal. If an external fault occurs, i.e. digital input drops to 0 VDC, the ACS 600 is stopped and the motor coasts to stop. A fault message is displayed on the Control Panel.

**30.04 MOTOR THERM  
PROT**

This parameter defines the operation of the motor thermal protection function which protects the motor from overheating.

**FAULT**

Displays a warning indication at the warning level. Displays a fault indication and stops the ACS 600 when the motor temperature reaches the 100% level.

**WARNING**

Warning indication is displayed when the motor temperature reaches the warning level (95% of the nominal value).

**NO**

No activity wanted.

**30.05 MOT THERM P  
MODE**

Selects the thermal protection mode. The motor protection is made by means of the thermal model or thermistor measurement.

The ACS 600 calculates the temperature of the motor using the following assumptions:

- The motor is at ambient temperature (30 °C) when power is applied to the ACS 600.
- Motor heating is calculated assuming a load curve ([Figure 6-15](#)). The motor will heat above nominal temperature if it operates in the region above the curve, and cool if it operates below the curve. The rate of heating and cooling is set by MOTOR THERM TIME.

---

**CAUTION:** Motor thermal protection will not protect the motor if the cooling of the motor is reduced due to dust and dirt.

---

### DTC

The DTC (Direct Torque Control) load curve is used for calculating heating of the motor. Motor thermal time is approximated for standard self-ventilated squirrel-cage motors as a function of the current of the motor and the number of pole pairs.

It is possible to scale the DTC load curve with Parameter [30.07 MOTOR LOAD CURVE](#) if the motor is used in conditions other than described above. Parameters [30.06 MOTOR THERM TIME](#), [30.08 ZERO SPEED LOAD](#) and [30.09 BREAK POINT](#) cannot be set.

### USER MODE

In this mode the user can define the operation of thermal protection by setting Parameters [30.06 MOTOR THERM TIME](#), [30.07 MOTOR LOAD CURVE](#), [30.08 ZERO SPEED LOAD](#) and [30.09 BREAK POINT](#).

### THERMISTOR

Motor thermal protection is activated with an I/O signal based on a motor thermistor.

This mode requires a motor thermistor or break contact of a thermistor relay connected between digital input DI6 and +24 V d.c. If direct thermistor connection is used, digital input DI6 activates when resistance rises higher than 4 k $\Omega$ . The drive stops if the Parameter [30.04 MOTOR THERM PROT](#) is preset as FAULT. DI6 is reset to zero when the resistance of the thermistor is between 0 and 1.5 k $\Omega$ .



**WARNING!** According to IEC 664, the connection of the thermistor to digital input DI6 of ACS 600 requires double or reinforced insulation between the live parts of the motor and the thermistor. Reinforced insulation entails a clearance and creepage of 8 mm (400/500 VAC equipment). If the thermistor assembly does not fulfil the requirement, the other I/O terminals of ACS 600 must be protected against contact, or a thermistor relay must be used to isolate the thermistor from the digital input.

---



**WARNING!** The default settings of the application macros define digital input DI6 as the source for the Start/Stop command. Redefine this setting before selecting THERMISTOR for Parameter [30.05 MOT THERM P MODE](#). In other words, ensure that digital input DI6 is not selected as signal source by any other parameter than [30.05 MOT THERM P MODE](#).

---

Alternative 1

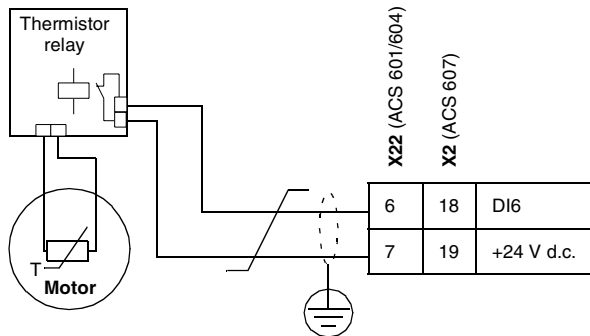

Alternative 2

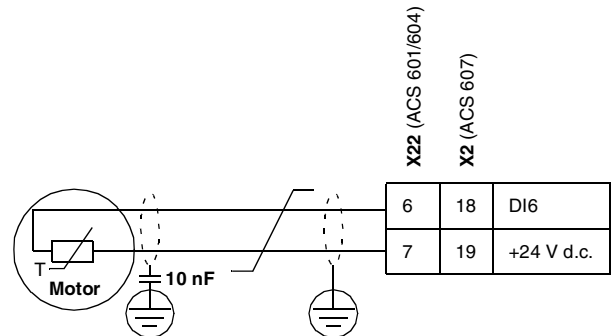

Figure 6-13 Thermistor connection. Alternative 2: At the motor end, the cable shield should be earthed through a 10 nF capacitor. If this is not possible, the shield is to be left unconnected.

30.06 MOTOR THERM TIME

This is the time within which the motor temperature reaches 63% of the final temperature rise. Figure 6-14 shows the definition of Motor Thermal Time. If the DTC mode is selected for motor thermal protection, the motor thermal time can be read from this parameter. This parameter can be set only if Parameter 30.05 MOT THERM P MODE is set to USER MODE.

If thermal protection according to UL requirements for NEMA-class motors is desired, use this rule of thumb: Motor Thermal Time equals  $35 \times t_6$  ( $t_6$  in seconds is the time that the motor can safely operate at six times its rated current, given by the motor manufacturer). The thermal time for a Class 10 trip curve is 350 s, for a Class 20 trip curve 700 s and for a Class 30 trip curve 1050 s.

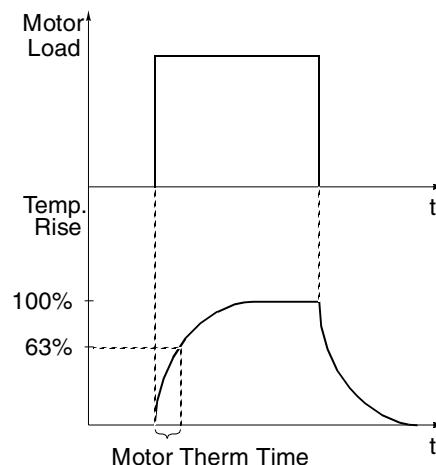

Figure 6-14 Motor Thermal Time.

**30.07 MOTOR LOAD CURVE**

The Motor Load Curve sets the maximum allowable operating load of the motor. When set to 100%, the maximum allowable load is equal to the value of Start-up Data Parameter [99.06 MOTOR NOM CURRENT](#). The load curve level should be adjusted if the ambient temperature differs from the nominal value.

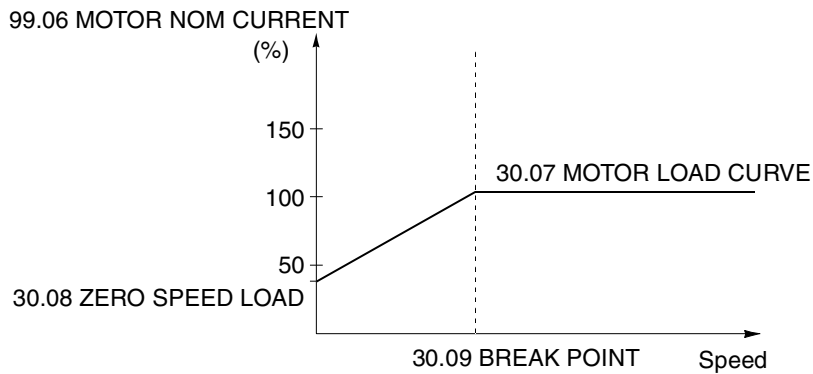

Figure 6-15 Motor Load Curve.

**30.08 ZERO SPEED LOAD**

This parameter defines the maximum allowable current at zero speed to define the Motor Load Curve.

**30.09 BREAK POINT**

This parameter defines the point at which the motor load curve begins to decrease from the maximum value set by Parameter [30.07 MOTOR LOAD CURVE](#) to the Parameter [30.08 ZERO SPEED LOAD](#). Refer to [Figure 6-15](#) for an example of motor load curve.

**30.10 STALL FUNCTION**

This parameter defines the operation of the stall protection. The protection is activated if the following conditions are valid at a time longer than the period set by Parameter [30.12 STALL TIME](#).

- The motor torque is close to the internal momentary changing limit of the motor control software that prevents the motor and the inverter from overheating or the motor from pulling out.
- The output frequency is below the level set by Parameter [30.11 STALL FREQ HI](#).

Stall protection is disabled in the scalar control mode (see Parameter [99.04 MOTOR CTRL MODE](#)).

**FAULT**

When the protection is activated the ACS 600 stops and a fault indication is displayed.

**WARNING**

A warning indication is displayed. The indication disappears in half of the time set by Parameter [30.12 STALL TIME](#).

**NO**

No activity is wanted.

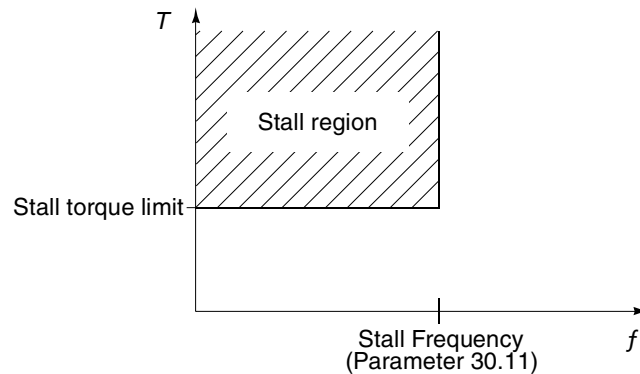

Figure 6-16 Stall protection.  $T$  is motor torque.

**30.11 STALL FREQ HI** This parameter sets the frequency value for the stall function.

**30.12 STALL TIME** This parameter sets the time value for the stall function.

**30.13 UNDERLOAD FUNC** Removal of motor load may indicate a process malfunction. The protection is activated if:

- The motor torque drops below the load curve selected by Parameter [30.15 UNDERLOAD CURVE](#).
- This condition has lasted longer than the time set by Parameter [30.14 UNDERLOAD TIME](#).
- Output frequency is higher than 10% of the nominal frequency of the motor.

The protection function assumes that the drive is equipped with a motor of the rated power.

Select NO; WARNING; FAULT according to the activity you prefer. With selection FAULT ACS 600 stops the motor and displays a fault message.

The underload function cannot be selected in the scalar control mode (see Parameter [99.04 MOTOR CTRL MODE](#)).

**30.14 UNDERLOAD TIME** Time limit for the underload logic.

**30.15 UNDERLOAD CURVE**

This parameter provides five selectable curves shown in Figure 6-17. If the load drops below the set curve for longer than the time set by Parameter 30.14 UNDERLOAD TIME, the underload protection is activated. Curves 1 ... 3 reach maximum at the motor rated frequency set by Start-up Data Parameter 99.07 MOTOR NOM FREQ.

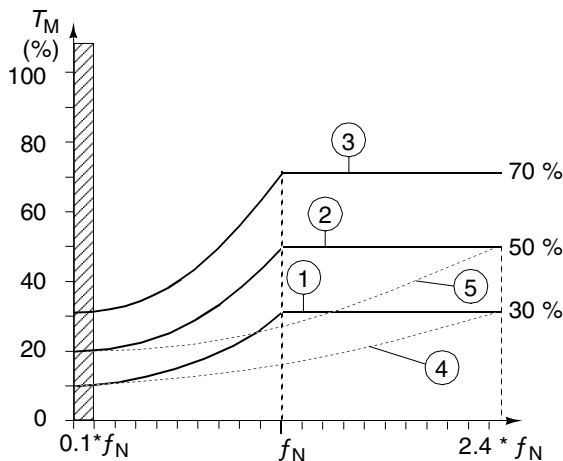

Figure 6-17 Underload curve types.  $T_M$  nominal torque of the motor,  $f_N$  nominal frequency of the motor.

---

**Note:** Underload protection functions only when ACS 600 output frequency is higher than 10% of the motor nominal frequency.

---

**30.16 MOTOR PHASE LOSS**

This parameter defines the operation when one or more motor phases are lost. Motor phase loss protection is disabled in the scalar control mode (see Parameter 99.04 MOTOR CTRL MODE).

**FAULT**

Fault indication is displayed and the ACS 600 stops.

**NO**

No activity wanted.

**30.17 EARTH FAULT**

This parameter defines the operation when an earth fault is detected in the motor or the motor cable.

**FAULT**

Fault indication is displayed and the ACS 600 stops.

**NO**

No activity wanted.

**30.18 PRESET FREQ**

Frequency which is used as a reference when fault occurs and fault function is set to preset frequency (see Parameter 30.01 AI<MIN FUNCTION, 30.02 PANEL LOSS and 30.19 COMM FAULT FUNC).

**30.19 COMM FAULT FUNC** This parameter defines the operation when the DDCS communication between the drive and the communication module (e.g. fieldbus adapter) is lost.

This parameter is visible only after a communication module has been activated with Parameter [98.02 COMM. MODULE LINK](#).

---

**CAUTION:** If you select PRESET FREQ or LAST FREQ, make sure that it is safe to continue operation in case analogue input signal is lost.

---

**FAULT**

A fault indication is given and the ACS 600 stops according to the setting of Parameter [21.03 STOP FUNCTION](#).

**NO**

No activity wanted.

**PRESET FREQ**

A warning indication is given and the speed is set according to Parameter [30.18 PRESET FREQ](#).

**LAST SPEED**

A warning indication is given and the speed is set to the level the ACS 600 was last operating at. This value is determined by the average speed over the last 10 seconds.

**30.20 MAIN REF DS T-OUT** Time delay for the Main Reference Data Set supervision function. See Parameter [30.19 COMM FAULT FUNC](#).

Default value is 1 s.

**0.1 ... 60 s**

**30.21 COMM FAULT RO/AO** When the DDCS communication between the drive and the communication module (e.g. fieldbus adapter) is lost, this parameter defines the operation of those relay outputs and analogue outputs that are operated through the fieldbus link (see Parameter [Group 14 RELAY OUTPUTS](#) and [Group 15 ANALOGUE OUTPUTS](#)). Default value is ZERO.

This parameter is visible only after a communication module has been activated with Parameter [98.02 COMM. MODULE LINK](#).

**ZERO**

Relay output is de-energised. Analogue output is set to zero.

**LAST VALUE**

Relay output keeps the last state before the communication loss. Analogue output will give the last value before the communication loss.

**30.22 AUX REF DS T-OUT** Time delay for the Auxiliary Reference Data Set supervision function. See Parameter [30.19 COMM FAULT FUNC](#). The drive automatically activates the supervision function 60 seconds after power switch-on if the Auxiliary Reference Data Set is in use, i.e. Parameter [90.01 AUX DS REF3](#), [90.02 AUX DS REF4](#), or [90.03 AUX DS REF5](#) has a value other than zero.

The application program also applies this delay time to the function defined with Parameter [30.21 COMM FAULT RO/AO](#).

Default value is 1 s.

**0.1 ... 60.0 s**



**Group 31 AUTOMATIC  
RESET**

The Range/Unit column in [Table 6-16](#) below shows the allowable parameter values. The text following the table explains the parameters in detail.

*Table 6-16 Group 31.*

Parameter	Range/Unit	Description
31.01 NUMBER OF TRIALS	0 ... 5	Number of faults limit for Autoreset logic.
31.02 TRIAL TIME	1.0 ... 180.0 s	Time limit for Autoreset logic.
31.03 DELAY TIME	0.0 ... 3.0 s	Time delay between the fault and the reset attempt.
31.04 OVERCURRENT	NO; YES	Enable automatic fault reset.
31.05 OVERVOLTAGE	NO; YES	Enable automatic fault reset.
31.06 UNDERVOLTAGE	NO; YES	Enable automatic fault reset.
31.07 AI SIGNAL<MIN	NO; YES	Enable automatic fault reset.

The Automatic fault reset system resets the faults selected with Parameters [31.04 OVERCURRENT](#), [31.05 OVERVOLTAGE](#), [31.06 UNDERVOLTAGE](#) and [31.07 AI SIGNAL<MIN](#).

**31.01 NUMBER OF  
TRIALS**

Sets the number of allowed autoresets within a certain time. The time is defined with Parameter [31.02 TRIAL TIME](#). The ACS 600 prevents additional autoresets and remains stopped until a successful reset is performed from the Control Panel or through a digital input.

**31.02 TRIAL TIME**

The time within which a limited number of fault autoresets is allowed. The allowed number of faults per this time period is given with Parameter [31.01 NUMBER OF TRIALS](#).

**31.03 DELAY TIME**

This parameter sets the time that the ACS 600 will wait after a fault occurs before attempting to reset. If set to zero, the ACS 600 will reset immediately. If set to a value higher than zero, the drive will wait before resetting.

**31.04 OVERCURRENT**

If YES is selected, the fault (motor overcurrent) is reset automatically after the delay set by Parameter [31.03 DELAY TIME](#) and the ACS 600 resumes normal operation.

**31.05 OVERVOLTAGE**

If YES is selected, the fault (DC bus overvoltage) is reset automatically after the delay set by Parameter [31.03 DELAY TIME](#) and the ACS 600 resumes normal operation.

**31.06 UNDERVOLTAGE**

If YES is selected, the fault (DC bus undervoltage) is reset automatically after the delay set by Parameter [31.03 DELAY TIME](#) and the ACS 600 resumes normal operation.

**31.07 AI SIGNAL<MIN** If YES is selected, the fault (analogue input signal under minimum level) is reset automatically after the delay set by Parameter [31.03 DELAY TIME](#).



---

**WARNING!** If Parameter [31.07 AI SIGNAL<MIN](#) is enabled, the drive may restart even after a long stop when the analogue input signal is restored. Ensure that the use of this feature will not cause physical injury and/or damage equipment.

---

**Group 32 SUPERVISION** The Range/Unit column in [Table 6-17](#) below shows the allowable parameter values. The text following the table explains the parameters in detail.

*Table 6-17 Group 32.*

Parameter	Range/Unit	Description
32.01 FREQ 1 FUNCTION	NO; LOW LIMIT; HIGH LIMIT; ABS LOW LIMIT	Frequency 1 supervision.
32.02 FREQ 1 LIMIT	- 120 Hz ... 120 Hz	Frequency 1 supervision limit.
32.03 FREQ 2 FUNCTION	NO; LOW LIMIT; HIGH LIMIT; ABS LOW LIMIT	Frequency 2 supervision.
32.04 FREQ 2 LIMIT	- 120 Hz ... 120 Hz	Frequency 2 supervision limit.
32.05 CURRENT FUNCTION	NO; LOW LIMIT; HIGH LIMIT	Motor current supervision.
32.06 CURRENT LIMIT	0 ... 1000 A	Motor current supervision limit.
32.07 REF1 FUNCTION	NO; LOW LIMIT; HIGH LIMIT	Reference 1 supervision.
32.08 REF1 LIMIT	0 ... 120 Hz	Reference 1 supervision limit.
32.09 REF2 FUNCTION	NO; LOW LIMIT; HIGH LIMIT	Reference 2 supervision.
32.10 REF2 LIMIT	0 ... 500%	Reference 2 supervision limit.
32.11 ACT1 FUNCTION	NO; LOW LIMIT; HIGH LIMIT	Actual 1 supervision.
32.12 ACT1 LIMIT	0 ... 200%	Actual 1 supervision limit.
32.13 ACT2 FUNCTION	NO; LOW LIMIT; HIGH LIMIT	Actual 2 supervision.
32.14 ACT2 LIMIT	0 ... 200%	Actual 2 supervision limit.

**32.01 *FREQ 1 FUNCTION***

This parameter allows you to activate a frequency supervision function. The relay outputs selected with Parameters [14.01 RELAY RO1 OUTPUT](#), [14.02 RELAY RO2 OUTPUT](#), [14.03 RELAY RO3 OUTPUT](#) and [14.04 EXT 2 REL OUTPUT 1](#) can be used to indicate if the frequency drops below (LOW LIMIT) or exceeds (HIGH LIMIT) the supervision limit.

**NO**

Supervision not used.

**LOW LIMIT**

Supervision will be activated if value is below the limit set.

**HIGH LIMIT**

Supervision will be activated if value is above the limit set.

**ABS LOW LIMIT**

Supervision will be activated if value is below the set limit. Limit is supervised in both rotating directions, forward and reverse (see the shaded area on the left).

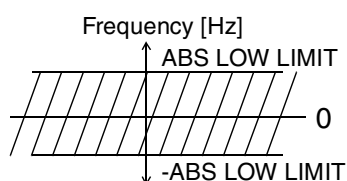

**32.02 *FREQ 1 LIMIT***

Frequency supervision limit adjustable from -120 to 120 Hz.

**32.03 *FREQ 2 FUNCTION***

Refer to Parameter [32.01 FREQ 1 FUNCTION](#).

**32.04 *FREQ 2 LIMIT***

Frequency supervision limit adjustable from -120 to 120 Hz. .

**32.05 *CURRENT FUNCTION***

Motor current supervision. Same options as with Parameter [32.01 FREQ 1 FUNCTION](#), excluding ABS LOW LIMIT and the selection by Parameters [14.04 EXT 2 REL OUTPUT 1](#)

**32.06 *CURRENT LIMIT***

Motor current supervision limit. Setting in actual amperes adjustable between 0 A ... 1000 A.

**32.07 *REF1 FUNCTION***

Reference 1 supervision. Same options as with Parameter [32.01 FREQ 1 FUNCTION](#), excluding ABS LOW LIMIT and the selection by Parameters [14.04 EXT 2 REL OUTPUT 1](#)

**32.08 *REF1 LIMIT***

Reference 1 supervision limit adjustable from 0 to 120 Hz.

**32.09 *REF2 FUNCTION***

Reference 2 supervision. Same options as with Parameter [32.01 FREQ 1 FUNCTION](#), excluding ABS LOW LIMIT and the selection by Parameters [14.04 EXT 2 REL OUTPUT 1](#)

**32.10 *REF2 LIMIT***

Reference 2 supervision limit adjustable from 0 to 500%.

**32.11 *ACT1 FUNCTION***

Actual value 1 supervision. Same options as with Parameter [32.01 FREQ 1 FUNCTION](#), excluding ABS LOW LIMIT and the selection by Parameters [14.03 RELAY RO3 OUTPUT](#)

**32.12 *ACT1 LIMIT***

Actual value 1 supervision limit adjustable from 0 to 200%.

- 32.13 ACT2 FUNCTION** Actual value 2 supervision. Same options as with Parameter [32.02](#) **FREQ 1 LIMIT**, excluding ABS LOW LIMIT and the selection by Parameters [14.03](#) **RELAY RO3 OUTPUT**
- 32.14 ACT2 LIMIT** Actual value 2 supervision limit adjustable from 0 to 200%.

**Group 33 INFORMATION**

These parameter values cannot be altered. The Range/Unit column in [Table 6-18](#) below shows the parameter values. The text following the table explains the parameters in detail.

Table 6-18 Group 33.

Parameter	Range/Unit	Description
33.01 SOFTWARE VERSION	xxxxxxx	Version of the ACS 600 firmware package.
33.02 APPL SW VERSION	xxxxxxx	Version of the application program.
33.03 TEST DATE	DDMMYY	Test date (day, month, year).

**33.01 SOFTWARE VERSION**

This parameter displays the type and version of the firmware package loaded into the ACS 600.

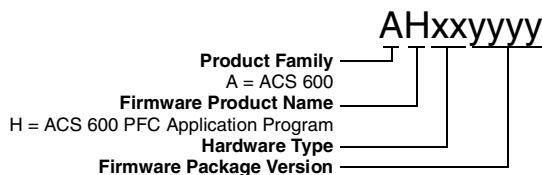

**33.02 APPL SW VERSION**

This parameter displays the version of the application program of your ACS 600.

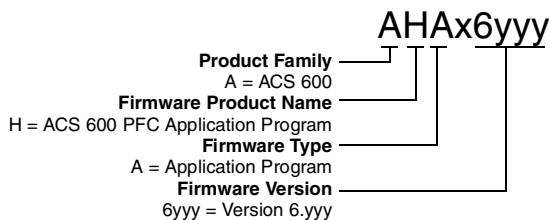

**33.03 TEST DATE**

This parameter displays the test date of your ACS 600.

**Group 51 COMM MOD  
DATA**

These parameters are visible, and need to be adjusted, only when a fieldbus adapter module (optional) is installed and activated with Parameter [98.02 COMM. MODULE LINK](#). For details on the parameters, refer to the manual of the fieldbus module.

These parameter settings are not affected by an application macro change.

**Group 52 STANDARD  
MODBUS**

These parameters define the basic settings for the Standard Modbus Link. See [Appendix C – Fieldbus Control](#).

Table 6-19 Group 52.

Parameter	Range	Description
52.01 STATION NUMBER	1 to 247	Device address. Two units with the same addresses are not allowed on-line. Default value is 1.
52.02 BAUDRATE	600; 1200; 2400; 4800; 9600	Transfer rate of the link in bit/s. Default value is 9600.
52.03 PARITY	NONE1STOPBIT; NONE2STOPBIT; ODD; EVEN	Usage of parity bit(s). Default value is ODD.

**Group 70 DDCS CONTROL**

The ACS 600 can communicate with external equipment via its DDCS-protocol fibre optic serial communication channels. The Parameters in Group 70 set the ACS 600 node addresses for the DDCS channels 0 and 2.

These parameter values need to be adjusted only in certain special cases, examples of which are given in the table below.

Table 6-20 Group 70.

Parameter	Range/Unit	Description
70.01 CHANNEL 0 ADDR	1...125	Node address for CH0. There must not be two nodes with the same address on-line. The setting need to be changed when a master station is connected to CH0 and it does not automatically change the address of the slave. Examples of such masters are an ABB Advant Controller AC 70 or another ACS 600.
70.02 CHANNEL 3 ADDR	1...254	Node address for CH3. There must not be two nodes with the same address on-line. Typically the setting need to be changed when ACS 600 is connected to a ring which consists of several ACS 600s and a PC with the DriveWindow® program running.



**Group 80 PI CONTROL**

These parameters are only visible when Parameter [99.02 APPLICATION MACRO](#) is set to PFC. The Range/Unit column in [Table 6-21](#) below shows the allowable parameter values. The text following the table explains the parameters in detail.

Table 6-21 Group 80.

Parameter	Range/Unit	Description
80.01 PI GAIN	0.1 ... 100	PI Controller Gain selection.
80.02 PI INTEG TIME	0.5 ... 1000 s	PI Controller integration time selection.
80.03 ERROR VALUE INV	NO; YES	PI Controller error value inversion.
80.04 ACTUAL VALUE SEL	ACT1; ACT1 - ACT2; ACT1 + ACT2; ACT1 * ACT2; ACT1/ACT2; MIN(A1,A2); MAX(A1,A2); sqrt(A1 - A2); sqA1+sqA2	PI Controller Actual signal selection.
80.05 ACTUAL1 INPUT SEL	NO; AI1; AI2; AI3	Actual 1 signal input selection.
80.06 ACTUAL2 INPUT SEL	NO; AI1; AI2; AI3	Actual 2 signal input selection.
80.07 ACT1 MINIMUM	-1000 ... 1000	Minimum scaling factor of the Actual 1.
80.08 ACT1 MAXIMUM	-1000 ... 1000	Maximum scaling factor of the Actual 1.
80.09 ACT2 MINIMUM	-1000 ... 1000	Minimum scaling factor of the Actual 2.
80.10 ACT2 MAXIMUM	-1000 ... 1000	Maximum scaling factor of the Actual 2.
80.11 ACT 1 UNIT SCALE	-999999 ... 999999	Value of display at Motor max speed.
80.12 ACTUAL 1 UNIT	NO; bar; %; °C; mg/l; kPa	Unit of the process speed.
80.13 ACT 2 UNIT SCALE	-999999 ... 999999	Scaling factor of the Actual 2.
80.14 ACTUAL 2 UNIT	NO; bar; %; °C mg/l; kPa	Unit of the Actual 2.
80.15 ACTUAL FUNC SCALE	-999999 ... 999999	Scaling factor for operation selected with Par. 80.04.

The minimum and maximum values of the PI Controller output are limited by Parameters [20.01 MINIMUM FREQUENCY](#) and [20.02 MAXIMUM FREQUENCY](#).

**80.01 PI GAIN** This parameter defines the gain of the PI Controller. If you select 1, a 10% change in error value causes the PI Controller output to change by 10% of the maximum frequency: If Parameter **20.02 MAXIMUM FREQUENCY** were 60 Hz, PI controller output would change 6 Hz.

*Table 6-22 Example: PI output change depending on relative error and gain setting when Parameter **20.02 MAXIMUM FREQUENCY** is 60 Hz.*

PI Gain	PI Output Change: 10% Change in Error	PI Output Change: 50% Change in Error
0.5	3 Hz (= $0.5 \times 0.1 \times 60$ Hz)	15 Hz (= $0.5 \times 0.5 \times 60$ Hz)
1.0	6 Hz (= $1.0 \times 0.1 \times 60$ Hz)	30 Hz (= $1.0 \times 0.5 \times 60$ Hz)
3.0	18 Hz (= $3.0 \times 0.1 \times 60$ Hz)	60 Hz (> $3.0 \times 0.5 \times 60$ Hz) (Limited by Parameter 20.02 MAXIMUM FREQUENCY)

**80.02 PI INTEG TIME** Defines the time in which the maximum output is achieved if a constant error value exists and the gain is 1. An integration time of 1 s denotes that a 100% change is achieved in 1 s.

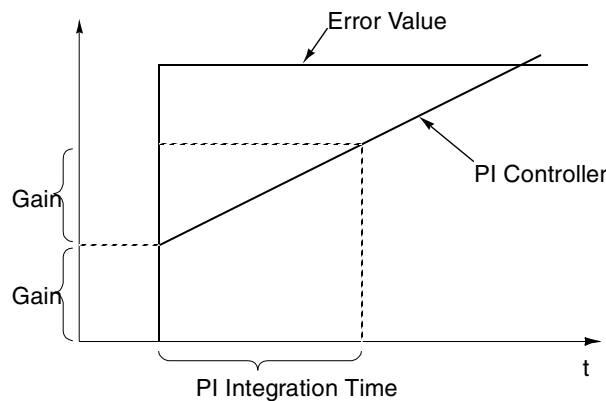

*Figure 6-18 PI Controller Gain, Integration Time, and Error Value.*

**Note:** Process PI controller need to be tuned slower than the speed controller (Group 23) to avoid resonance. Recommendable range of settings are the following, the value of the parameter **80.01 PI GAIN** should be 10 to 20% of the value **23.01 GAIN** and value **80.02 PI INTEG TIME** should be 5 to 10 times longer than **23.02 INTEGRATION TIME**.

**80.03 ERROR VALUE INV** This parameter allows you to invert the Error value (and thus the operation of the PI Controller). Normally, a decrease in Actual Signal (feedback) causes an increase in drive speed. If a decrease in Actual is desired to cause a decrease in speed, set Error Value Invert to YES.

- 80.04 ACTUAL VALUE SEL** **ACT1; ACT1 - ACT2; ACT1 + ACT2; ACT1 \* ACT2; ACT1/ACT2; MIN(A1,A2) ; MAX(A1,A2); sqrt(A1-A2); sqA1 + sqA2**  
 Actual signal for the PI Controller is selected by this parameter. Source for ACT1 is set with Parameter [80.05 ACTUAL 1 INPUT SEL](#). Source for ACT2 is set with Parameter [80.06 ACTUAL 2 INPUT SEL](#). In the list above, A1 denotes ACT1, A2 denotes ACT2. MIN(A1,A2) sets the parameter value to either ACT1 or ACT2, depending which one has the smallest value. sqrt(A1 - A2) sets the parameter value to square root of (ACT1 - ACT2). sqA1+sqA2 sets the parameter value to square root of ACT1 plus square root of ACT2.  
 Use the sqrt(A1 - A2) or sqA1+sqA2 function if the PI Controller controls flow with a pressure transducer measuring the pressure difference over a flow meter.
- 80.05 ACTUAL 1 INPUT SEL** **NO; AI1, AI2 or AI3**  
 This parameter selects one of the analogue inputs as actual signal 1 e.g. ACT1 used in Parameter 80.4 value selection.
- 80.06 ACTUAL 2 INPUT SEL** **NO; AI1, AI2 or AI3**  
 This parameter selects one of the analogue inputs as actual signal 2 e.g. ACT2 used in Parameter 80.4 value selection.
- 80.07 ACT1 MINIMUM** Minimum value for Actual Value 1. Defined as % of the difference between the maximum and minimum values of the selected analogue input. The setting range is -1000% to +1000%. Refer to Parameters 13.01, 13.02, 13.06, 13.07, 13.11 and 13.12 for analogue input minimum and maximum settings.  
 The value of this parameter can be calculated using the formula below. The minimum of the actual value refers to the minimum of the span of the actual value.

$$\text{ACTUAL 1 MINIMUM} = \frac{\text{Minimum of actual value (V or mA)} - \text{MINIMUM AI (1, 2 or 3)}}{\text{MAXIMUM AI (1, 2 or 3)} - \text{MINIMUM AI (1, 2 or 3)}} \times 100\%$$

**Example:** The pressure of a pipe system is to be controlled between 0 and 10 bar. The pressure transducer has an output range of 4 to 8 V, corresponding to pressure between 0 and 10 bar. The minimum output voltage of the transducer is 2 V and the maximum is 10 V, so the minimum and the maximum of the analogue input is set to 2 V and 10 V. ACTUAL 1 MINIMUM is calculated as follows:

$$\text{ACTUAL 1 MINIMUM} = \frac{4 \text{ V} - 2 \text{ V}}{10 \text{ V} - 2 \text{ V}} \cdot 100\% = 25\%$$

**80.08 ACT1 MAXIMUM** Maximum value for the Actual Value 1. ACT1 MAXIMUM is defined as % of the difference between the maximum and minimum values of the selected analogue input. The setting range is -1000% to +1000%. Refer to Parameters 13.01, 13.02, 13.06, 13.07, 13.11 and 13.12 for analogue input minimum and maximum settings.

The value of this parameter can be calculated using the formula below. The maximum of the actual value refers to the highest value the actual signal can attain.

$$\text{ACTUAL 1 MAXIMUM} = \frac{\text{Maximum of actual value (V or mA)} - \text{MINIMUM AI (1, 2 or 3)}}{\text{MAXIMUM AI (1, 2 or 3)} - \text{MINIMUM AI (1, 2 or 3)}} \cdot 100\%$$

Refer to the description of the example at Parameter [80.08 ACT1 MAXIMUM](#) in this case is:

$$\text{ACTUAL 1 MAXIMUM} = \frac{8 \text{ V} - 2 \text{ V}}{10 \text{ V} - 2 \text{ V}} \cdot 100\% = 75\%$$

[Figure 6-19](#) shows three examples of actual value scaling.

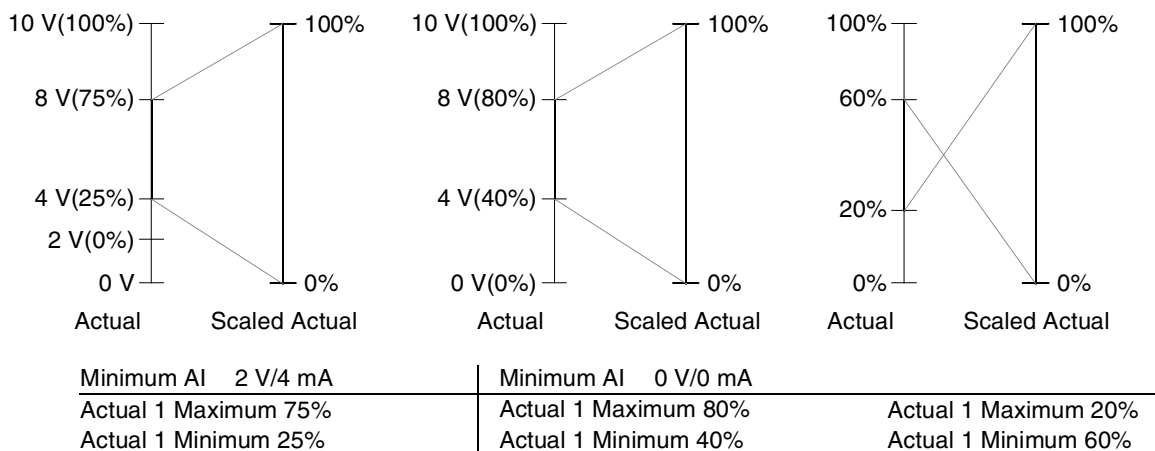

*Figure 6-19 Actual Value Scaling.*

**80.09 ACT2 MINIMUM** Refer to Parameter [80.07 ACT1 MINIMUM](#).

**80.10 ACT2 MAXIMUM** Refer to Parameter [80.08 ACT1 MAXIMUM](#).

**80.11 ACT1 UNIT SCALE** This parameter matches the Actual Value displayed in the Control Panel and the unit defined by Parameter [80.12 ACTUAL 1 UNIT](#).

**80.12 ACTUAL 1 UNIT** **NO; bar; %; C; mg/l; kPa**  
The possible choices for the Actual Value unit are NO (no unit is displayed), bar, %, C, mg/l or kPa.

**80.13 ACT2 UNIT SCALE** Refer to Parameter [80.11 ACT1 UNIT SCALE](#).

- 80.14 ACTUAL 2 UNIT** Refer to Parameter **80.12 ACTUAL 1 UNIT**.
- 80.15 ACTUAL FUNC SCALE** Used to scale the result of the arithmetical operation selected by Parameter **80.04 ACTUAL VALUE SEL**. The scaled value can be read through an analogue output (see Parameter **15.01 ANALOGUE OUTPUT1**).

**Group 81 PFC  
CONTROL**

These parameters are visible only when Parameter 99.02 APPLICATION MACRO is set to PFC. The Range/Unit column in Table 6-23 shows the allowable parameter settings. The text following the table explains the parameters in detail.

Table 6-23 Group 81.

Parameter	Range / Unit	Description
81.01 SET POINT	PANEL; EXTERNAL	Process reference source selection
81.02 CONST SET POINT	0.0 ... 100.0%	Constant set point (process reference).
81.03 REFERENCE STEP 1	0.0 ... 100.0%	Reference increase 1.
81.04 REFERENCE STEP 2	0.0 ... 100.0%	Reference increase 2.
81.05 REFERENCE STEP 3	0.0 ... 100.0%	Reference increase 3.
81.06 SLEEP DELAY	0.0 ... 3600.0 s	Time delay for the Sleep function.
81.07 SLEEP LEVEL	0.0 ... 120.0 Hz	Level for activation of Sleep function.
81.08 WAKE UP LEVEL	0.0 ... 100.0%	Level for deactivation of Sleep function.
81.09 START FREQ 1	0.0 ... 120.0 Hz	Start frequency for the first auxiliary motor.
81.10 START FREQ 2	0.0 ... 120.0 Hz	Start frequency for the second auxiliary motor.
81.11 START FREQ 3	0.0 ... 120.0 Hz	Start frequency for the third auxiliary motor.
81.12 LOW FREQ 1	0.0 ... 120.0 Hz	Output frequency at which the first auxiliary motor stops.
81.13 LOW FREQ 2	0.0 ... 120.0 Hz	Output frequency at which the second auxiliary motor stops.
81.14 LOW FREQ 3	0.0 ... 120.0 Hz	Output frequency at which the third auxiliary motor stops.
81.15 AUX MOT START DLY	0.0 ... 3600.0 s	Start delay for the auxiliary motors.
81.16 AUX MOT STOP DLY	0.0 ... 3600.0 s	Stop delay for the auxiliary motors.
81.17 NBR OF AUX MOTORS	ZERO; ... ; FOUR	Number of auxiliary motors.
81.18 AUTOCHANGE INTERV	0 h 0 min ... 336 h 0 min	Time interval for the Autochange function (up to 14 days).
81.19 AUTOCHANGE LEVEL	0.0 ... 100.0%	Supervision limit for the the Autochange function (up to 14 days).
81.20 INTERLOCKS	ON; OFF	Motor interlocks.
81.21 REGUL BYPASS CTRL	NO; YES	Bypass PI Regulator.
81.22 PFC START DELAY	0 ... 10000 ms	Start delay for the speed regulated motor.
81.23 REFERENCE STEP 4	0.0 ... 100.0%	Reference increase 4.
81.24 START FREQ 4	0.0 ... 120 Hz	Start frequency for the fourth auxiliary motor.
81.25 LOW FREQ 4	0.0 ... 120 Hz	Output frequency at which the fourth auxiliary motor stops.
81.26 SLEEP SELECTION	OFF; ...; EXT DI2	Source selector for Sleep function control.

- 81.01 SET POINT** This parameter defines the reference signal source for the Pump and Fan Control block.
- EXTERNAL**  
Process reference is read from a source defined with Parameter [11.06 EXT REF2 SELECT](#). The Control panel must be in remote mode.
- If the Control panel is in local mode (L shown on the first row of the display), the Panel gives direct frequency reference and no PFC logics are in operation.
- 
- Note:** To be able to read the process reference from the Panel in local mode, the type of the keypad reference should be changed to REF2 (%) (Parameter [11.01 KEYPAD REF SEL](#)).
- 
- PANEL**  
Process reference is a constant value set with parameter [81.02 CONST SET POINT](#).
- 81.02 CONST SET POINT** This parameter sets a constant process reference for the PI controller. PI controller follows this reference if Parameter [81.01 SET POINT](#) is set to PANEL.
- 81.03 REFERENCE STEP 1** This parameter sets a percentage that is added to the process reference when one auxiliary (constant speed) motor is running. Default value is 0%.
- Example:** An ACS 600 operates three parallel pumps that pump water into a pipe. The pressure in the pipe is controlled. The constant pressure reference is set by parameter [81.02 CONST SET POINT](#). During low water consumption, only the speed-regulated pump is run. When water consumption increases, constant-speed pumps are started; first one pump, and if the demand is still growing, also the other pump. When water flow increases, the pressure loss increases between the beginning (measurement site) and the end of the pipe. By setting suitable reference steps (parameters [81.03 REFERENCE STEP 1](#) and [81.04 REFERENCE STEP 2](#)) the process reference is increased along the increasing pumping capacity. The reference steps compensate the growing pressure loss and prevent the pressure fall at the end of the pipe.
- 81.04 REFERENCE STEP 2** This parameter sets a percentage that is added to the process reference when two auxiliary (constant speed) motors are running. Default value is 0%. See Parameter [81.03 REFERENCE STEP 1](#).
- 81.05 REFERENCE STEP 3** This parameter sets a percentage value that is added to the process reference when three auxiliary (constant speed) motors are running. Default value is 0%. See Parameter [81.03 REFERENCE STEP 1](#).

**81.06 SLEEP DELAY** This parameter sets the delay for the Sleep function (see [Figure 6-20](#)). If the ACS 600 output frequency is below a set level ([81.07 SLEEP LEVEL](#)) longer than the Sleep Delay, the ACS 600 is stopped, and the Control Panel shows the warning message “SLEEP MODE”.

See also Parameter [81.26 SLEEP SELECTION](#).

**81.07 SLEEP LEVEL** This parameter sets the frequency limit for the Sleep function (See [Figure 6-20](#)). When the ACS 600 output frequency falls below the Sleep Level the Sleep Delay counter is started. When the ACS 600 output frequency rises above the Sleep Level the Sleep Delay counter is reset.

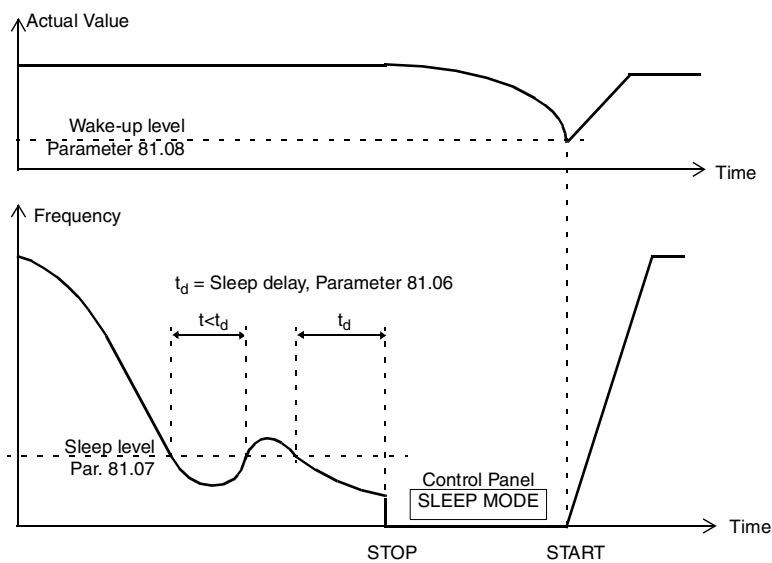

Figure 6-20 Operation of the Sleep function.

**Sleep Function ON/OFF:**

If this parameter is set to zero, the Sleep function is not active. See also Parameter [81.26 SLEEP SELECTION](#).

---

**CAUTION:** To use the Sleep function, the Sleep Level setting should be greater than the minimum frequency setting (value of Parameter [20.01 MINIMUM FREQUENCY](#)). Otherwise the ACS 600 output frequency will never fall below the Sleep Level.

---

**81.08 WAKE UP LEVEL** This Parameter sets the process actual value limit for the Sleep function (See [Figure 6-20](#)). When the actual value falls below the limit, the Sleep function is interrupted.

The wake-up level is defined in percent of the used process reference value.



**Example:** PFC program follows a process reference set by Parameter [81.02 CONST SET POINT](#). Table below shows the wake-up level with two process reference settings, and two wake-up level settings..

Value of <a href="#">81.02 CONST SET POINT</a>	Value of <a href="#">81.08 WAKE UP LEVEL</a>	Wake-up Level
100%	50%	50% of 100% = 50%
80%	40%	40% of 80% = 32%

**Note:** If Regulator Bypass control ([81.21 REGUL BYPASS CTRL](#)) is active or the PI process controller is inverted ([80.03 ERROR VALUE INV](#)), the Sleep function is interrupted when the actual value exceeds the wake-up level. In that case the wake-up level is taken as an absolute percentage value (of 100%).

**81.09 START FREQ 1** Parameter sets a frequency limit (see [Figure 6-21](#)).

When the output frequency of the ACS 600 exceeds ([81.09 START FREQ 1](#) + 1 Hz) and no auxiliary motors are running, the Start Delay counter is started. If the output frequency still exceeds ([81.09 START FREQ 1](#) + 1 Hz) as the time set with Parameter [81.15 AUX MOT START DLY](#) elapses, the first auxiliary motor is started.

After the first auxiliary motor is started, the output frequency is decreased by ([81.09 START FREQ 1](#) - [81.12 LOW FREQ 1](#)).

**Note:** Start Frequency 1 should fall within limits [81.12 LOW FREQ 1](#) and ([20.02 MAXIMUM FREQUENCY](#) - 1 Hz).

**81.10 START FREQ 2** This parameter sets a frequency limit (see [Figure 6-21](#)).

When the output frequency of the ACS 600 exceeds ([81.10 START FREQ 2](#) + 1 Hz) and one auxiliary motor is running, the Start Delay counter is started. If the output frequency still exceeds ([81.10 START FREQ 2](#) + 1 Hz) as the time set with Parameter [81.15 AUX MOT START DLY](#) elapses, the second auxiliary motor is started.

After the second auxiliary motor is started, the output frequency is decreased by ([81.10 START FREQ 2](#) - [81.13 LOW FREQ 2](#)).

**Note:** Start Frequency 2 should fall within limits [81.13 LOW FREQ 2](#) and ([20.02 MAXIMUM FREQUENCY](#) - 1 Hz).

**81.11 START FREQ 3** This parameter sets a frequency limit (see [Figure 6-21](#)).

When the output frequency of the ACS 600 exceeds ([81.11 START FREQ 3](#) + 1 Hz) and two auxiliary motors are running, the Start Delay counter is started. If the output frequency still exceeds ([81.11 START FREQ 3](#) + 1 Hz) as the time set with Parameter [81.15 AUX MOT START DLY](#) elapses, the third auxiliary motor is started.

After the third auxiliary motor is started, the output frequency is decreased by ([81.11 START FREQ 3](#) - [81.14 LOW FREQ 3](#)).

---

**Note:** Start Frequency 3 should fall within limits [81.14 LOW FREQ 3](#) and ([20.02 MAXIMUM FREQUENCY](#) - 1 Hz).

---

**81.12 LOW FREQ 1** This parameter sets a frequency limit (see [Figure 6-21](#)).

When the output frequency of the ACS 600 falls below ([81.12 LOW FREQ 1](#) - 1 Hz) and one auxiliary motor is running, the Stop Delay counter is started. If the output frequency remains lower than ([81.12 LOW FREQ 1](#) - 1 Hz) as the time set with Parameter [81.16 AUX MOT STOP DLY](#) elapses, the first auxiliary motor is stopped.

After the auxiliary motor is stopped, the output frequency is increased by ([81.09 START FREQ 1](#) - [81.12 LOW FREQ 1](#)).

---

**Note:** Stop Frequency 1 should fall within limits ([20.01 MINIMUM FREQUENCY](#) +1 Hz) and [81.09 START FREQ 1](#). If minimum value [20.01 MINIMUM FREQUENCY](#) is increased above LOW FREQ, the new value for LOW FREQ = min +2 Hz will also be set.

---

**81.13 LOW FREQ 2** This parameter sets a frequency limit (see [Figure 6-21](#)).

When the output frequency of the ACS 600 falls below ([81.13 LOW FREQ 2](#) - 1 Hz) and two auxiliary motors are running, the Stop Delay counter is started. If the output frequency remains lower than ([81.13 LOW FREQ 2](#) - 1 Hz) as the time set with Parameter [81.16 AUX MOT STOP DLY](#) elapses, the second auxiliary motor is stopped.

After the auxiliary motor is stopped, the output frequency is increased by ([81.10 START FREQ 2](#) - [81.13 LOW FREQ 2](#)).

---

**Note:** Stop Frequency 2 should fall within limits ([20.01 MINIMUM FREQUENCY](#) +1 Hz) and [81.10 START FREQ 2](#). If minimum value [20.01 MINIMUM FREQUENCY](#) is increased above LOW FREQ, the new value for LOW FREQ = min +2 Hz will also be set.

---

**81.14 LOW FREQ 3** This parameter sets a frequency limit (see Figure 6-21).

When the output frequency of the ACS 600 falls below (81.14 LOW FREQ 3 - 1 Hz) and three auxiliary motors are running, the Stop Delay counter is started. If the output frequency remains lower than (81.14 LOW FREQ 3 - 1 Hz) as the time set with Parameter 81.16 AUX MOT STOP DLY elapses, the third auxiliary motor is stopped.

After the auxiliary motor is stopped, the output frequency is increased by (81.11 START FREQ 3 - 81.14 LOW FREQ 3).

**Note:** Stop Frequency 3 should fall within limits (20.01 MINIMUM FREQUENCY +1 Hz) and 81.11 START FREQ 3. If minimum value 20.01 MINIMUM FREQUENCY is increased above LOW FREQ, the new value for LOW FREQ = min +2 Hz will also be set.

**81.15 AUX MOT START DLY** Sets the Start Delay for the auxiliary motors. See Figure 6-21 for more information.

**81.16 AUX MOT STOP DLY** Sets the Stop Delay for the auxiliary motors. See Parameter 81.12 LOW FREQ 1 for more information.

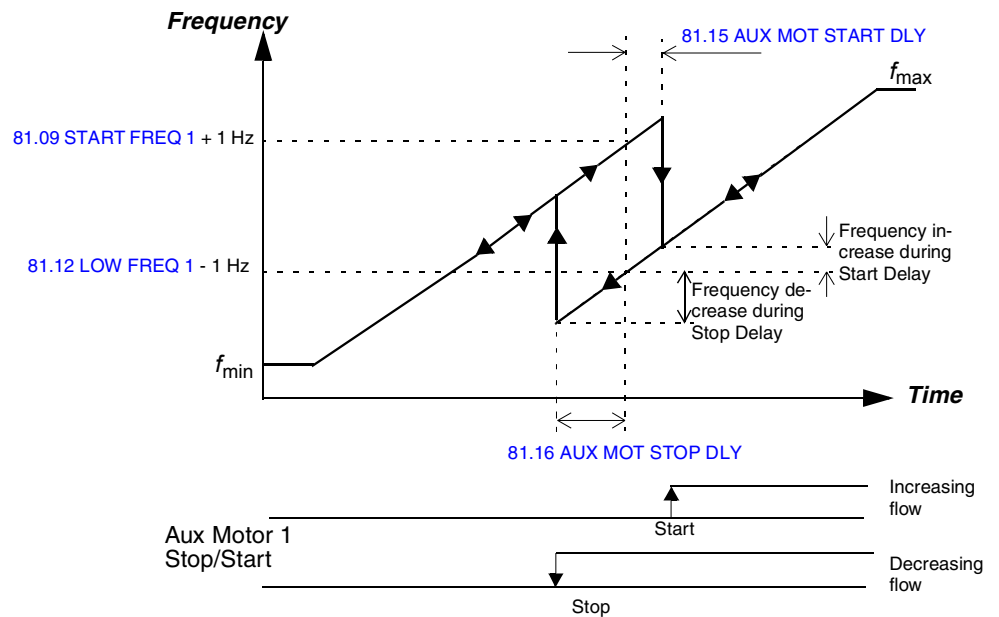

Figure 6-21 Start Frequency, Low Frequency, Start Delay and Stop Delay.

81.17 NBR OF AUX  
MOTORS

This parameter sets the number of auxiliary motors. Parameter can be altered only when the ACS 600 is stopped.

---

**Note:** After changing the number of auxiliary motors, check the settings of the Relay RO Outputs in Parameter Group 14.

---

**Note:** Without additional hardware, the ACS 600 with the PFC Application Macro supports the use of one or two auxiliary motors (i.e. two or three motors in total). The use of three to four auxiliary motors is possible with an optional external digital input/output module (NDIO). See section [Group 98 OPTION MODULES](#).

---

**Note:** Three auxiliary motors can be used without additional hardware if the Interlocks and Autochange functions are not used (Parameters [81.18 AUTOCHANGE INTERVAL](#), [81.19 AUTOCHANGE LEVEL](#) and [81.20 INTERLOCKS](#)).



---

**WARNING:** If the Autochange function is used, also the Interlocks function must be taken in use.

81.18 AUTOCHANGE  
INTERVAL

This parameter sets the interval for the Autochange function. See Parameter [81.19 AUTOCHANGE LEVEL](#) for information on the operation of Autochange.

**0 h 00 min (disabled) ... 336 h 0 min**

---

**Note:** The time is counted only when ACS 600 Start signal is on.



---

**WARNING:** If the Autochange function is used, the Interlocks must be in use and Parameter [21.03 STOP FUNCTION](#) must be set to COAST. In Autochange system there is a contactor between ACS 600 output terminals and the speed controlled motor. The contactor is damaged if opened without first interrupting the ACS 600 inverter power stage switching. The inverter switching is interrupted when the Interlock is switched off and the stop mode is coast.

---

**81.19 AUTOCHANGE LEVEL** This parameter sets a percentage from which the output frequency limit for the Autochange logic is calculated.

$$f_{ac} = \frac{\text{Par. 81.19}}{\left(\frac{100\%}{1 + \text{Par 81.17}}\right)} \times \text{Par. 20.02}$$

$f_{ac}$  = Output frequency below which the Autochange is allowed  
 Par. 81.19 = AUTOCHANGE LEVEL  
 Par. 81.17 = NUMBER OF AUX MOTORS  
 Par. 20.02 = MAXIMUM FREQUENCY

The motor starting order is changed when the Autochange Interval is elapsed from the previous Autochange and the output frequency is below the level calculated from the equation above. The autochange is indicated by the warning message “AUTOCHANGE” on the Control Panel.

**Example:** There are three motors in the system (value of Parameter **81.17 NBR OF AUX MOTORS** is two), Autochange level is set to 25% (Parameter **81.19 AUTOCHANGE LEVEL**), Maximum frequency is 52 Hz (Parameter **20.02 MAXIMUM FREQUENCY**).

The starting order is changed when:

1. ACS 600 output frequency is below 39 Hz  
 = 25%/(100%/(1+2)) × 52 Hz
2. Autochange Interval (**81.18 AUTOCHANGE INTERVAL**) has elapsed from previous Autochange.

When both conditions are valid, the Autochange procedure is performed:

1. All motors are stopped. The Control Panel displays “AUTOCHANGE”.
2. The starting order is changed (the starting order counter steps onward).
3. The contactor that connects the speed regulated motor to ACS 600 is switched on.
4. Time set with Parameter **81.22 PFC START DELAY** is waited.
5. Speed regulated motor is energised and normal PFC operation starts.

The starting order is changed as follows:

- First start: Motor 1, motor 2, motor 3.
- Second start: Motor 2, Motor 3, motor 1.
- Third start: Motor 3, motor 1, motor 2. (etc...)

Starting order cannot be changed with an external signal.

If the Autochange level is zero and Autochange Interval has elapsed, Autochange occurs when a motor stop, e.g. the Sleep function, is active.

---

**Note:** After the Parameter [81.19 AUTOCHANGE LEVEL](#) is set, it should always be checked by using the formula above that the corresponding output frequency value is within allowed range, i.e. within limits [20.01 MINIMUM FREQUENCY](#) and [20.02 MAXIMUM FREQUENCY](#). Otherwise no Autochange is possible.

---

**Note:** The Autochange logic can be disabled by setting parameter [81.18 AUTOCHANGE INTERVAL](#) to zero.

---

**Note:** When ACS 600 power supply is switched off, the values of the starting order counter and Autochange Interval counter are stored in the memory. The counters continue from the stored values after the power supply is switched on again.

#### 81.20 INTERLOCKS

This parameter controls the use of the Interlocks function.



---

**WARNING:** If the Autochange function is used, also the Interlocks must be taken into use (see Parameter [81.18 AUTOCHANGE INTERVAL](#)).

---

#### OFF

Interlocks function is not in use. Digital inputs 2, 3 and 4 are available for other purposes.

Depending on the number of auxiliary motors (Parameter [81.17 NBR OF AUX MOTORS](#)) the relay outputs are used according to following table (Parameters [14.01 RELAY RO1 OUTPUT](#), [14.02 RELAY RO2 OUTPUT](#) and [14.03 RELAY RO3 OUTPUT](#)).

Table 6-24 Usage of relay outputs when the Interlocks function is not in use.

Number of aux. motors Par. 81.17	Usage of relay outputs	Description
0	–	The speed regulated motor (motor no. 1) is directly connected to the ACS 600.
1	RO1	The speed regulated motor (motor no. 1) is directly connected to the ACS 600. Relay output RO1 controls the Start/Stop contactor of the first auxiliary motor (motor no. 2).
2	RO1 RO2	The speed regulated motor (motor no. 1) is directly connected to the ACS 600. Relay output RO1 controls the Start/Stop contactor of the first auxiliary motor (motor no. 2). Relay output RO2 controls the Start/Stop contactor of the second auxiliary motor (motor no. 3).
3	RO1 RO2 RO3	The speed regulated motor (motor no. 1) is directly connected to the ACS 600. Relay output RO1 controls the Start/Stop contactor of the first auxiliary motor (motor no. 2). Relay output RO2 controls the Start/Stop contactor of the second auxiliary motor (motor no. 3). Relay output RO3 controls the Start/Stop contactor of the third auxiliary motor (motor no. 4).
4	RO1 RO2 RO3 PFC NDIO (RO1)	The speed regulated motor (motor no. 1) is directly connected to the ACS 600. Relay output RO1 controls the Start/Stop contactor of the first auxiliary motor (motor no. 2). Relay output RO2 controls the Start/Stop contactor of the second auxiliary motor (motor no. 3). Relay output RO3 controls the Start/Stop contactor of the third auxiliary motor (motor no. 4). PFC extension module relay output 1 controls the Start/Stop contactor of the fourth auxiliary motor (motor no. 5).

**ON**

Interlocks function is in use. Depending on the number of motors, digital inputs 2, 3 and 4 are reserved for the interlock signals according to the following table.

*Table 6-25 Usage of relay outputs and digital inputs when the Interlock function is in use.*

Number of aux. motors Par. 81.17	Usage of relay outputs and digital inputs	Description
0	DI2 RO1	DI2 monitors the status of motor no. 1. Relay output RO1 controls the Start/Stop contactor of motor no. 1.
1	DI2, DI3 RO1, RO2	DI2 and DI3 monitor the status of motors no. 1 and 2 respectively. Relay outputs RO1 and RO2 control the Start/Stop contactors of motors no. 1 and 2 respectively.
2	DI2, DI3, DI4 RO1, RO2, RO3	DI2, DI3 and DI4 monitor the status of motors no. 1, 2 and 3 respectively. Relay outputs RO1, RO2 and RO3 control the Start/Stop contactors of motors no. 1, 2 and 3 respectively.
3	DI2, DI3, DI4 PFC NDIO (DI1) RO1, RO2, RO3 PFC NDIO (RO1)	DI2, DI3 and DI4 monitor the status of motors no. 1, 2 and 3 respectively. The status of motor no. 4 is wired to digital input 1 of the optional PFC extension (type NDIO) module. See Parameter <a href="#">98.01 DI/O PFC EXT.</a> Relay outputs RO1, RO2 and RO3 control the Start/Stop contactors of motors no. 1, 2 and 3 respectively. PFC extension module relay output 1 controls the Start/Stop contactor of motor no. 4. See Parameter <a href="#">98.01 DI/O PFC EXT.</a>
4	DI2, DI3, DI4 PFC NDIO (DI1, DI2) RO1, RO2, RO3 PFC NDIO (RO1, RO2)	DI2, DI3 and DI4 monitor the status of motors no. 1, 2 and 3 respectively. The status of motor no. 4 is wired to digital input 1 of the optional PFC extension (type NDIO) module. The status of motor no. 5 is wired to digital input 2 of the same module. See Parameter <a href="#">98.01 DI/O PFC EXT.</a> Relay outputs RO1, RO2 and RO3 control the Start/Stop contactors of motors no. 1, 2 and 3 respectively. PFC extension module relay output 1 controls the Start/Stop contactor of motor no. 4. PFC extension module relay output 2 controls the Start/Stop contactor of motor no. 5. See Parameter <a href="#">98.01 DI/O PFC EXT.</a>



Each Interlock circuit should be wired as follows:

1. A contact of the On/Off switch of the motor must be wired to the Interlock circuit. The PFC logic detects if a motor is switched off. The logic does not try to start a switched-off motor; the next available motor is started instead.
2. A contact of the motor thermal relay (or another protective device in the motor circuit) must be wired to the Interlock input. The PFC logic detects if the thermal relay energises. The motor is stopped.

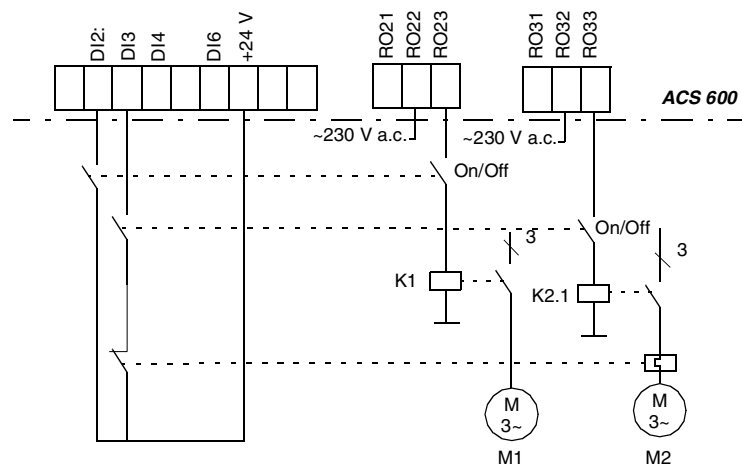

Figure 6-22 Wiring the interlocks of a PFC system with two motors. There is a thermal relay in the supply circuit of M2.

If the Interlock circuit of the speed regulated motor is switched off, the motor is stopped and all ACS 600 relay outputs are de-energised, stopping the other motors as well. Then the ACS 600 restarts. The next motor in Autochange order will be started as regulated.

If the Interlock circuit of a constant speed (auxiliary) motor is switched off, ACS 600 does not attempt to start the motor until the Interlock circuit is switched on again. The other motors operate normally.

#### 81.21 REGUL BYPASS CTRL

Regulator by-pass control is needed in special applications only. An example is given in [Figure 6-23](#) and [Figure 6-24](#).

##### NO

Process PI regulator is in use.

##### YES

The process PI regulator is bypassed. The signal connected to the PI Controller actual value pin (Parameter [80.04 ACTUAL VALUE SEL](#)) is used as the frequency reference. The automatic start and stop of constant speed motors is referred to this actual value signal instead of the output of the PI regulator.

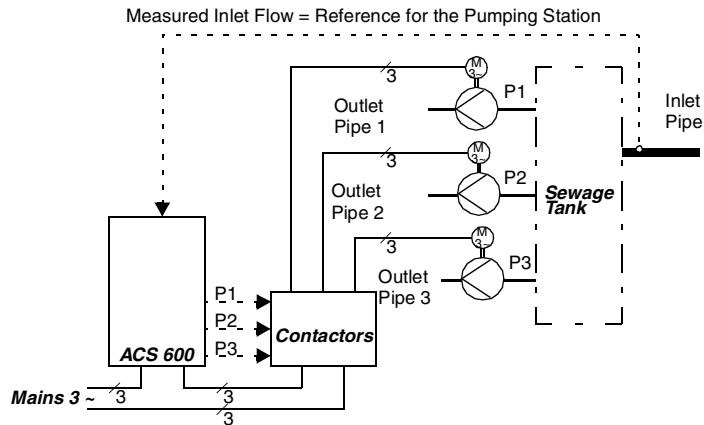

Figure 6-23 Regulator bypass control. The capacity of the pumping station (outlet flow) follows the measured inlet flow.

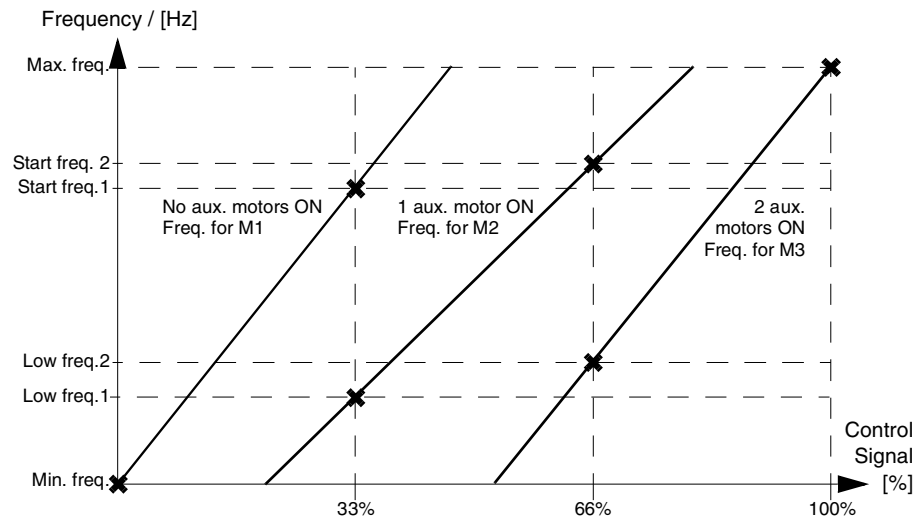

Figure 6-24 The slopes of the lines describe the relation between the control signal and the frequency of the controlled motor in a three-motor system.

- 81.22 PFC START DELAY** This parameter sets the start delay for the speed-regulated motor. The setting does not affect the starting of the constant speed (direct-on-line) motors. The delay functions as follows:
1. The contactor that connects the speed-regulated motor to the ACS 600 is switched on (by a ACS 600 relay output).
  2. PFC Start Delay is waited.
  3. The speed-regulated motor is energised and normal PFC operation starts.

---

**CAUTION:** There should always be a PFC Start Delay set if the motors are equipped with star-delta starters. The delay must be set longer than the time setting of the star-delta starter. After the motor is switched on by the relay output of the ACS 600, there must be enough time for the star-delta starter to first switch to star and then back to delta before the motor is connected to ACS 600.

---

**81.23 REFERENCE STEP 4** This parameter sets a percentage value that is added to the process reference when four auxiliary (constant speed) motors are running. Default value is 0%. See Parameter [81.03 REFERENCE STEP 1](#).

**81.24 START FREQ 4** This parameter sets a frequency limit (see [Figure 6-21](#)).

When the output frequency of the ACS 600 exceeds ([81.24 START FREQ 4](#) + 1 Hz) and three auxiliary motors are running, the Start Delay counter is started. If the output frequency still exceeds ([81.24 START FREQ 4](#) + 1 Hz) as the time set with Parameter [81.15 AUX MOT START DLY](#) elapses, the fourth auxiliary motor is started.

After the fourth auxiliary motor is started, the output frequency is decreased by ([81.24 START FREQ 4](#) - [81.25 LOW FREQ 4](#)).

---

**Note:** Start Frequency 4 should fall within limits [81.25 LOW FREQ 4](#) and ([20.02 MAXIMUM FREQUENCY](#) - 1 Hz).

---

**81.25 LOW FREQ 4** This parameter sets a frequency limit (see [Figure 6-21](#)).

When the output frequency of the ACS 600 falls below ([81.25 LOW FREQ 4](#) - 1 Hz) and four auxiliary motors are running, the Stop Delay counter is started. If the output frequency remains lower than ([81.25 LOW FREQ 4](#) - 1 Hz) as the time set with Parameter [81.16 AUX MOT STOP DLY](#) elapses, the fourth auxiliary motor is stopped.

After the auxiliary motor is stopped, the output frequency is increased by ([81.24 START FREQ 4](#) - [81.25 LOW FREQ 4](#)).

---

**Note:** Stop Frequency 4 should fall within limits ([20.01 MINIMUM FREQUENCY](#) +1 Hz) and [81.24 START FREQ 4](#). If minimum value [20.01 MINIMUM FREQUENCY](#) is increased above LOW FREQ, the new value for LOW FREQ = min +2 Hz will also be set.

---

**81.26 SLEEP SELECTION** This parameter controls the Sleep function.

**OFF**

The Sleep function is disabled.

**INTERNAL**

The Sleep function is activated and inactivated as defined with Parameters [81.06 SLEEP DELAY](#), [81.07 SLEEP LEVEL](#) and [81.08 WAKE UP LEVEL](#).

**DI1; ...; EXT DI2**

The Sleep conditions set with Parameters [81.07 SLEEP LEVEL](#) and [81.08 WAKE UP LEVEL](#) must be fulfilled, AND this digital input must be on (1) before the ACS 600 can enter the Sleep mode. The Sleep delay, set with Parameter [81.06 SLEEP DELAY](#), is in effect.

---

**Note:** If Parameter [81.21 REGUL BYPASS CTRL](#) is set to NO, the selected digital input forces the reference of the PI regulator to zero. If Parameter [81.21 REGUL BYPASS CTRL](#) is set to YES, the selected digital input forces the actual value of the PI regulator to zero.

---

**Group 82 PRESSURE CONTROL** The Range/Unit column in [Table 6-26](#) shows the allowable parameter settings. The text following the table explains the parameters in detail.

Table 6-26 Group 82.

Parameter	Range / Unit	Description
82.01 INPUT PROT CTRL	NOT SEL; ...; FAULT	Pump/fan inlet pressure monitoring activation and mode selection
82.02 AI MEASURE INLET	NOT USED; ...; EXT AI2	Analogue input selection for pump/fan inlet pressure measurement
82.03 AI LOW LEVEL	0.0 ... 100.0%	Minimum inlet pressure
82.04 DI STATUS INLET	NOT USED; ...; EXT DI2	Digital input selection for pump/fan inlet pressure switch
82.05 INPUT CTRL DLY	0 ... 60 s	Delay after which warning/indication/fault activated upon pressure loss
82.06 OUTPUT PROT CTRL	NOT SEL; ...; FAULT	Pump/fan outlet pressure monitoring activation and mode selection
82.07 AI MEASURE OUTLET	NOT USED; ...; EXT AI2	Analogue input selection for pump/fan outlet pressure measurement
82.08 AI HIGH LEVEL	0.0 ... 100.0%	Maximum outlet pressure
82.09 DI STATUS OUTLET	NOT USED; ...; EXT DI2	Digital input selection for pump/fan outlet pressure switch
82.10 OUTPUT CTRL DLY	0 ... 60 s	Delay after which warning/indication/fault activated upon detection of too high pressure
82.11 PI REF DEC TIME	0.01 ... 3600.00 s	PI controller output ramp-down time
82.12 APPL PROFILE CTRL	CONTROL DEV; APPL OUTPUT	Application profile monitoring: selection of monitored signal
82.13 PROFILE OUTP LIM	0 ... 500%	Application profile monitoring: indication limit
82.14 PROF LIMIT ON DLY	0.0 ... 100.0 h	Application profile monitoring: indication delay

- 82.01 INPUT PROT CTRL** This parameter enables, and selects the mode of, the monitoring of pump/fan inlet pressure.
- NOT SEL**  
Pump/fan inlet pressure monitoring disabled.
- WARNING**  
Detection of low inlet pressure produces a warning on the Control Panel display.
- PROTECT**  
Detection of low inlet pressure produces a warning on the Control Panel display. The output of the PI controller is ramped down to zero.
- FAULT**  
Detection of low inlet pressure trips the ACS 600 on a fault.
- 82.02 AI MEASURE INLET** Selects the analogue input for pump/fan inlet pressure monitoring.
- NOT USED**  
No analogue input used.
- AI1; AI2; AI3; EXT AI1; EXT AI2**  
Pump/fan inlet pressure monitored through selected input.
- 82.03 AI LOW LEVEL** Sets the supervision limit for pump/fan inlet pressure measurement. If the value of the selected analogue input falls below this limit, the action defined with Parameter [82.01 INPUT PROT CTRL](#) is taken after the delay set with Parameter [82.05 INPUT CTRL DLY](#).
- 0 ... 100%**  
This range corresponds to 0 ... 10 V or 0 ... 20 mA on the analogue input. With bipolar inputs, the absolute input value is monitored.
- 82.04 DI STATUS INLET** Selects the digital input for connection of a pressure switch at the pump/fan inlet. The “normal” state is 1 (on). If the selected input goes to 0 (off), the action defined with Parameter [82.01 INPUT PROT CTRL](#) is executed after the delay set with Parameter [82.05 INPUT CTRL DLY](#).
- NOT USED**  
No digital input used.
- DI1; DI2; DI3; DI4; DI5; DI6; EXT DI1; EXT DI2**  
Pump/fan inlet pressure monitored through selected input.
- 82.05 INPUT CTRL DLY** Sets the delay after which the action defined with Parameter [82.01 INPUT PROT CTRL](#) is taken upon detection of low inlet pressure.
- 0 ... 60 s**

- 82.06 OUTPUT PROT CTRL** This parameter enables, and selects the mode of, the monitoring of pump/fan outlet pressure.
- NOT SEL**  
Pump/fan outlet pressure monitoring disabled.
- WARNING**  
Detection of high outlet pressure produces a warning on the Control Panel display.
- PROTECT**  
Detection of high outlet pressure produces a warning on the Control Panel display. The output of the PI controller is ramped down to zero.
- FAULT**  
Detection of high outlet pressure trips the ACS 600 on a fault.
- 82.07 AI MEASURE OUTLET** Selects the analogue input for pump/fan outlet pressure monitoring.
- NOT USED**  
No analogue input used.
- AI1; AI2; AI3; EXT AI1; EXT AI2**  
Pump/fan outlet pressure monitored through selected input.
- 82.08 AI HIGH LEVEL** Sets the supervision limit for pump/fan outlet pressure measurement. If the value of the selected analogue input exceeds this limit, the action defined with Parameter [82.06 OUTPUT PROT CTRL](#) is taken after the delay set with Parameter [82.10 OUTPUT CTRL DLY](#) expires.
- 0 ... 100%**  
This range corresponds to 0 ... 10 V or 0 ... 20 mA on the analogue input. With bipolar inputs, the absolute input value is monitored.
- 82.09 DI STATUS OUTLET** Selects the digital input for connection of a pressure switch at the pump/fan outlet. The “normal” state is 1 (on). If the selected input goes to 0 (off), the action defined with Parameter [82.06 OUTPUT PROT CTRL](#) is executed after the delay set with Parameter [82.10 OUTPUT CTRL DLY](#) expires.
- NOT USED**  
No digital input used.
- DI1; DI2; DI3; DI4; DI5; DI6; EXT DI1; EXT DI2**  
Pump/fan outlet pressure monitored through selected input.
- 82.10 OUTPUT CTRL DLY** Sets the delay after which the action defined with Parameter [82.06 OUTPUT PROT CTRL](#) is taken upon detection of high outlet pressure.
- 0 ... 60 s**
- 82.11 PI REF DEC TIME** The PI controller output ramp-down time. See selection **PROTECT** at Parameters [82.01 INPUT PROT CTRL](#) and [82.06 OUTPUT PROT CTRL](#).

**82.12 APPL PROFILE CTRL** Parameters 82.12 to 82.14 provide the Application Profile protection feature, based on long-term monitoring of an internal status signal. If the selected signal exceeds (and remains above) the supervision limit for a longer time than the set delay, the internal status signal “PROFILE HIGH” is set to 1. The signal can be selected to control a relay output. (See Parameter [Group 14 RELAY OUTPUTS](#).)

**CONTROL DEV**

The signal [1.25 CONTROL DEVIATION](#) is monitored and compared to Parameter [82.13 PROFILE OUTP LIM](#).

**APPL OUTPUT**

The signal [1.15 APPL BLOCK OUTPUT](#) is monitored and compared to Parameter [82.13 PROFILE OUTP LIM](#).

**82.13 PROFILE OUTP LIM** Supervision limit for the Application Profile protection.  
**0 ... 500%**

**82.14 PROF LIMIT ON DLY** Delay time for the Application Profile protection.



**Group 90 D SET REC ADDR**

These parameters are visible only when fieldbus communication is activated with Parameter [98.02 COMM. MODULE LINK](#).

These settings are not affected by an application macro change.

Table 6-27 Group 90.

Parameter	Range	Description
90.01 AUX DS REF3	0 ... 8999	These parameters enable parameter adjustment through fieldbus reference. See <a href="#">Appendix C – Fieldbus Control</a> .
90.02 AUX DS REF4	0 ... 8999	
90.03 AUX DS REF5	0 ... 8999	
90.04 MAIN DS SOURCE	1 ... 255	Defines the data set number from which the drive reads the Control Word, Reference REF1 and Reference REF2. See <a href="#">Appendix C – Fieldbus Control</a> .
90.05 AUX DS SOURCE	1 ... 255	Defines the data set number from which the drive reads the References REF3, REF4 and REF5. See <a href="#">Appendix C – Fieldbus Control</a> .

**Group 92 D SET TR ADDR**

These parameters are visible only when fieldbus communication is activated with Parameter [98.02 COMM. MODULE LINK](#).

These parameter settings are not affected by an application macro change.

Table 6-28 Group 92.

Parameter	Range	Description
92.01 MAIN DS STATUS WORD	302 (fixed, not visible)	These parameters define the contents of Data sets 2 and 4, sent by the ACS 600 to the fieldbus master station. See <a href="#">Appendix C – Fieldbus Control</a> .
92.02 MAIN DS ACT1	0 ... 9999	
92.03 MAIN DS ACT2	0 ... 9999	
92.04 AUX DS ACT3	0 ... 9999	
92.05 AUX DS ACT4	0 ... 9999	
92.06 AUX DS ACT5	0 ... 9999	

**Group 98 OPTION MODULES**

The parameters of this group are set if an option module is installed. For more information on option modules refer to the option module manuals.

These parameter settings will remain the same even though the application macro is changed.

Table 6-29 Group 98.

Parameter	Range	Description
98.01 DI/O PFC EXT	NO; YES	PFC extension module (type NDIO) activation.
98.02 COMM. MODULE LINK	NO; FIELDBUS; ADVANT; STD MODBUS; CUSTOMISED	Communication module selection. See also Parameter Group 51.
98.03 DI/O EXT MODULE 2	NO; YES	Digital I/O extension module (type NDIO) selection.
98.04 AI/O EXT MODULE	NO; NAI0-01; NAI0-02	Analogue I/O extension module (type NAI0) selection.
98.05 COMM INTERFACE	ABB DRIVES; CSA 2.8/3.0	Communication profile selection

**98.01 DI/O PFC EXT**

Set to YES if an external digital input/output module (NDIO, optional) is installed on fibre optic channel CH1. Set the module node address to 6. For more information see module manual.

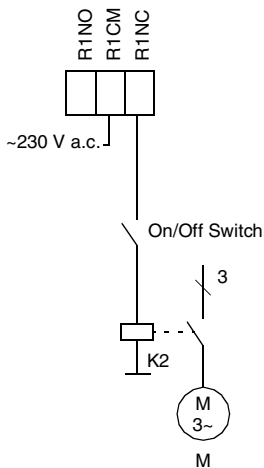

The module is used by the PFC Macro as the control signal interface to the fourth and fifth motors (interlock and Start/Stop). The usage of the input/output channels are defined below:

- Relay output 1 of the module controls the fourth motor.
- The interlock indication contact of the fourth motor is connected to digital input 1 of the module.
- Relay output 2 of the module controls the fifth motor if Parameter [81.17 NBR OF AUX MOTORS](#) is set to FOUR. Otherwise, the output is programmable by means of Parameter [14.05 EXT 2 REL OUTPUT 2](#).
- If the Interlocks function (see Parameter [81.20 INTERLOCKS](#)) is in use, the interlock indication contact of the fifth motor is connected to digital input 2 of the module. Otherwise, digital input 2 of the module replaces the standard digital input DI2 on the NIOC board.

<b>98.02 COMM. MODULE LINK</b>	<p>Selects the external serial communication interface. See <a href="#">Appendix C – Fieldbus Control</a>.</p> <p><b>NO</b> No external serial communication in use.</p> <p><b>FIELDBUS</b> ACS 600 communicates with a communication module (e.g. fieldbus adapter) via CH0 Fieldbus Adapter link. See also Parameter <a href="#">Group 51 COMM MOD DATA</a>.</p> <p><b>ADVANT</b> ACS 600 communicates with an Advant OCS system via CH0 Fieldbus Adapter link. See also Parameter <a href="#">Group 70 DDCS CONTROL</a>.</p> <p><b>STD MODBUS</b> ACS 600 communicates with a Modbus controller via the Standard Modbus link. See also Parameter <a href="#">Group 52 STANDARD MODBUS</a>.</p> <p><b>CUSTOMISED</b> ACS 600 can be controlled via two serial interfaces simultaneously. The control sources must be defined by the user with Parameters <a href="#">90.04 MAIN DS SOURCE</a> and <a href="#">90.05 AUX DS SOURCE</a>.</p>
<b>98.03 DI/O EXT MODULE 2</b>	<p>Set to YES if an external digital input/output module 2 (NDIO, optional) is installed on fibre optic channel CH1. Set the module node address to 3. For more information see module manual.)</p> <hr/> <p><b>Note:</b> The digital inputs 1 and 2 of the module replace the standard digital inputs DI3 and DI4 on the standard I/O board, However, if the interlocks are in use (Parameter <a href="#">81.20 INTERLOCKS</a> is ON), the PFC program reads the inputs DI3 and DI4 of the NIOC board. The digital inputs 1 and 2 of the module are not read.</p> <hr/> <p>The digital outputs are programmable by means of Parameters <a href="#">14.04 EXT 2 REL OUTPUT 1</a> and <a href="#">14.05 EXT 2 REL OUTPUT 2</a>.</p>
<b>98.04 AI/O EXT MODULE</b>	<p>Set to NAIO-01 or NAIO-02 if an external analogue input/output extension module (optional) is installed on fibre optic channel CH1. Set the module node address to 5. For more information see module manual.</p> <p><b>NO</b> Communication between drive and NAIO module inactive.</p> <p><b>NAIO-01; NAIO-02</b> Communication between drive and NAIO module active.</p> <p>Select according to the actual module type designation. When connecting an NAIO-03, the setting depends on the selected operation mode of the module (see module manual).</p>

Analogue input AI1 of NAIO module replaces standard analogue input AI3.

Analogue input AI2 of NAIO module replaces standard analogue input AI2.

Analogue output AI1 of NAIO module replaces standard analogue output AO1.

Analogue output AI2 of NAIO module replaces standard analogue output AO1.

---

**Note:** When connecting a module with bipolar inputs (such as an NAIO-03 in Bipolar Mode, or an NAIO-02), refer to Parameters [11.03 EXT REF1 SELECT](#) and [11.06 EXT REF2 SELECT](#).

---

**98.07 COMM  
INTERFACE**

This parameter is visible only when fieldbus communication is activated with Parameter [98.02 COMM. MODULE LINK](#).

This parameter defines the profile on which the communication with the fieldbus or another ACS 600 is based. For more information, see [Appendix C – Fieldbus Control](#).

**ABB DRIVES; CSA 2.8/3.0**

## Chapter 7 – Fault Tracing

---



**WARNING!** All electrical installation and maintenance work described in this chapter should only be undertaken by a qualified electrician. The *Safety Instructions* on the first pages of this manual and the appropriate hardware manual must be followed.

---

### **Fault Tracing**

The ACS 600 is equipped with advanced protection features that continuously guard the unit against damage and down time due to incorrect operating conditions and electrical and mechanical malfunctions.

This chapter explains the ACS 600 fault tracing procedure with the Control Panel.

All Warning and Fault messages are presented in tables below with information on the cause and remedy for each case. Most Warning and Fault conditions can be identified and cured with that information. If not, contact an ABB service representative.

---

**CAUTION!** Do not attempt any measurement, parts replacement or other service procedure not described in this manual. Such action will void guarantee, endanger correct operation, and increase downtime and expense.

---

The Warning message disappears when any of the Control Panel keys are pressed. The Warning will reappear in one minute if conditions remain unchanged. If the frequency converter is operated with the Control Panel detached, the red LED in the Control Panel mounting platform indicates Fault condition.

For setting of programmable warning and fault messages and functions, refer to [Chapter 6 – Parameters](#).

---

### **Fault Resetting**

An active fault can be reset either by pressing the keypad **RESET** key, by digital input or fieldbus, or switching the supply voltage off for a while. When the fault has been removed, the motor can be started.

---



**WARNING!** If an external source for start command is selected and it is ON, the ACS 600 (with Standard Application Program) will start immediately after fault reset. (If the fault has not been removed, the ACS 600 will trip again.)

---

**Fault History**







When a Fault is detected, it is stored in the Fault History. The last Faults and Warnings are stored with the time the Fault was detected.

---



**WARNING!** After a fault reset, the drive will start if the start signal is on. Before the reset, switch off the external start signal or ensure that it is safe to start.

---

The Fault History can be viewed by pressing  or  in the Actual Signal Display Mode. The Fault History can then be scrolled with  and . To exit the Fault History press  or . The Fault History can be cleared by pressing the **RESET** key.

**Fault and Warning Messages** The Tables below show the warning and fault messages.

Table 7-1 The Warning Messages generated by the drive firmware. <sup>PFC</sup>) for PFC Application only

WARNING	CAUSE	WHAT TO DO
ACS 600 TEMP	The ACS 600 internal temperature is excessive. A warning is given if inverter module temperature exceeds 115 °C.	Check ambient conditions. Check air flow and fan operation. Check heatsink fins for dust pick-up. Check motor power against unit power.
AI < MIN FUNC (programmable Fault Function 30.01)	An analogue control signal has fallen below minimum allowed value. This can be caused by an incorrect signal level or a failure in the control wiring.	Check for proper analogue control signal levels. Check the control wiring. Check AI < MIN FUNC Fault Function parameters.
AUTOCHANGE <sup>PFC</sup> )	The autochange function is performed.	Refer to the description of the parameters <a href="#">81.18 AUTOCHANGE INTERVAL</a> and <a href="#">81.19 AUTOCHANGE LEVEL</a> .
COMM MODULE (programmable Fault Function)	Cyclical communication between ACS 600 and fieldbus/ACS 600 Master is lost. The fault function is in use in remote control when the control place used is controlled from communication module.	Check the status of communication module. See <a href="#">Appendix C – Fieldbus Control</a> and the appropriate fieldbus manual. Check parameter settings of Group 51. Check fibre optic cable connections between AMC board channel 0 and communication module. Check connections between control system and adapter module. Check if the bus master is not communicating or configured.
ENCODER ERR	Communication fault between the pulse encoder and the NTAC module or between the NTAC module and the ACS 600.	Check the pulse encoder and its wiring, the NTAC module, Parameter Group 50 settings and the fibre optic connections on NAMC channel CH1.
ID DONE	The ACS 600 has performed the motor identification magnetisation and is ready for operation. This warning belongs to the normal start-up procedure.	Continue drive operation.
ID MAGN	Motor identification magnetisation is on. This warning belongs to the normal start-up procedure.	Wait until the drive indicates that motor identification is completed.
ID MAGN REQ	Motor identification is required. This warning belongs to the normal start-up procedure. The drive expects the user to select how the motor identification is to be performed: By ID magnetisation or by ID Run.	To start the ID magnetisation: Press the Start key. To start the ID Run procedure: Select the Identification Run type (see Parameter <a href="#">99.10 MOTOR ID RUN</a> ).
ID N CHANGED	The ID number of the drive has been changed from 1 in Drive Selection Mode (the change is not shown on the display).	To change the ID number back to 1 go to Drive Selection Mode by pressing <b>DRIVE</b> . Press <b>ENTER</b> . Set the ID number to 1. Press <b>ENTER</b> .
ID RUN DONE	The ACS 600 has performed the Identification Run and is ready for operation. This warning belongs to the ID Run procedure.	Continue drive operation.

WARNING	CAUSE	WHAT TO DO
ID RUN SEL	Motor Identification Run is selected, and the drive is ready to start the ID Run. This warning belongs to the ID Run procedure.	Press Start key to start the Identification Run.
ID RUNNING	Motor Identification Run is on.	Wait until the drive indicates that Identification Run is completed.
INLET LOW <sup>PFC)</sup> (programmable Fault Function 82.01 ... 82.05)	Pressure at pump/fan inlet too low.	Check for a closed valve on the inlet side of the pump/fan. Check piping for leaks.
MACRO CHANGE	Macro is restoring or user Macro is being saved.	Please wait.
MOTOR STALL (programmable Fault Function 30.10)	Motor is operating in the stall region. This can be caused by excessive load or insufficient motor power.	Check motor load and the ACS 600 ratings. Check MOTOR STALL Fault Function parameters.
MOTOR STARTS	Motor Identification Run starts. This warning belongs to the IR Run procedure.	Wait until the drive indicates that motor identification is completed.
MOTOR TEMP (programmable Fault Function 30.04 ... 30.10)	Motor temperature is too high (or appears to be too high). This can be caused by excessive load, insufficient motor power, inadequate cooling or incorrect start-up data.	Check motor ratings, load and cooling. Check start-up data. Check MOTOR TEMP Fault Function parameters.
OUTLET HIGH <sup>PFC)</sup> (programmable Fault Function 82.06 ... 82.10)	Pressure at pump/fan outlet too high.	Check piping for blocks.
PANEL LOSS (programmable Fault Function 30.02)	A Control Panel selected as active control location for the ACS 600 has ceased communicating.	Check Control Panel connector. Replace Control Panel in the mounting platform. Check PANEL LOSS Fault Function parameters.
SLEEP MODE <sup>PFC)</sup>	The sleep function is activated.	Refer to the description of Parameters <a href="#">81.06 SLEEP DELAY</a> and <a href="#">81.07 SLEEP LEVEL</a> .
THERMISTOR (programmable Fault Function 30.04 ... 30.05)	Motor thermal protection mode selected as THERMISTOR and the temperature is excessive.	Check motor ratings and load. Check start-up data. Check thermistor connections for digital input DI6 of NIOC board.
UNDERLOAD (programmable Fault Function 30.13)	Motor load is too low. This can be caused by a release mechanism in the driven equipment.	Check for a problem in the driven equipment. Check UNDERLOAD Fault Function parameters.



Table 7-2 The Warning Messages generated by the Control Panel firmware.

WARNING	CAUSE	WHAT TO DO
DOWNLOAD FAILED	Download function of the panel has failed. No data has been copied from the Panel to the ACS 600.	Retry (there might be interference on the link). Contact an ABB representative.
DRIVE INCOMPATIBLE DOWNLOADING NOT POSSIBLE	Program versions in the Panel and in the ACS 600 do not match. It is not possible to copy data from Panel to the ACS 600.	Check the program versions (see Parameter <a href="#">Group 33 INFORMATION</a> ).
DRIVE IS RUNNING DOWNLOADING NOT POSSIBLE	Downloading is not possible while the motor is running.	Stop the motor. Perform the downloading.
NO COMMUNICATION (X)	There is a cabling problem or a hardware malfunction on the Panel Link.  (4) = Panel type is not compatible with the version of the drive application program. CDP 312 Panel does not communicate with Standard Application Program (ACS) version 3.x or earlier. The CDP 311 Panel does not communicate with Standard Application Program (ACS) version 5.x or later.	Check the Panel Link connections. Press the RESET key. The panel reset may take up to half a minute, please wait.  Check the Panel type and the version of the drive application program. The Panel type is printed on the cover of the Panel. The application program version is stored in Parameter <a href="#">33.02 APPL SW VERSION</a> .
NO FREE ID NUMBERS ID NUMBER SETTING NOT POSSIBLE	The Panel Link already includes 31 stations.	Disconnect another station from the link to free an ID number.
NOT UPLOADED DOWNLOADING NOT POSSIBLE	No upload function has been performed.	Perform the Upload function before downloading. See <i>Chapter 2 – Overview of ACS 600 Programming and the CDP 312 Control Panel</i> .
UPLOAD FAILED	Upload function of the panel has failed. No data has been copied from the ACS 600 to the Panel.	Retry (there might be interference on the link). Contact an ABB representative.
WRITE ACCESS DENIED PARAMETER SETTING NOT POSSIBLE	Certain parameters do not allow changes while motor is running. If tried, no change is accepted, and a warning is displayed.  Parameter Lock is on.	Stop the motor then change the parameter value.  Open the parameter Lock (see Parameter <a href="#">16.02 PARAMETER LOCK</a> ).

Table 7-3 The Fault Messages generated by the drive firmware.

FAULT	CAUSE	WHAT TO DO
ACS 600 TEMP	The ACS 600 internal temperature is excessive. The trip level of inverter module temperature is 125 °C.	Check ambient conditions. Check air flow and fan operation. Check heatsink fins for dust pick-up. Check motor power against unit power.
AI < MIN FUNC (programmable Fault Function 30.01)	An analogue control signal is below minimum allowed value. This can be caused by incorrect signal level or a failure in the control wiring.	Check for proper analogue control signal levels. Check the control wiring. Check AI < MIN FUNC Fault Function parameters.
AMBIENT TEMP	I/O Control board temperature is lower than -5...0 °C or exceeds +73...82 °C.	Check air flow and fan operation.
COMM MODULE (programmable Fault Function)	Cyclical communication with ACS 600 and fieldbus/ACS 600 Master is lost. The fault function is in use in remote control when the used control place is controlled from communication module.	Check the status of communication module. See <a href="#">Appendix C – Fieldbus Control</a> and the appropriate fieldbus manual. Check parameter settings of Group 51. Check fibre optic cable connections between AMC or NDCO board channel 0 and communication module. Check connections between control system and adapter module. Check if the bus master is not communicating or configured.
DC OVERVOLT	Intermediate circuit DC voltage is excessive. DC overvoltage trip limit is $1.3 \cdot U_{1max}$ , where $U_{1max}$ is the maximum value of the mains voltage range. For 400 V units, $U_{1max}$ is 415 V. For 500 V units, $U_{1max}$ is 500 V. The actual voltage in the intermediate circuit corresponding to the mains voltage trip level is 728 V d.c. for 400 V units and 877 V d.c. for 500 V units.	Check that the overvoltage controller is on (Parameter <a href="#">20.05 OVERVOLTAGE CTRL</a> ). Check mains for static or transient overvoltages. Check Braking Chopper and Resistor (if used). Check deceleration time. Use Coasting To Stop function (if applicable). Retrofit the frequency converter with a Braking Chopper and a Braking Resistor.
DC UNDERVOLT	Intermediate circuit DC voltage is not sufficient. This can be caused by a missing mains phase, a blown fuse or a rectifier bridge internal fault.  DC undervoltage trip limit is $0.65 \cdot U_{1min}$ , where $U_{1min}$ is the minimum value of the mains voltage range. For 400 V and 500 V units, $U_{1min}$ is 380 V. The actual voltage in the intermediate circuit corresponding to the mains voltage trip level is 334 V d.c.	Check mains supply and fuses.
EARTH FAULT (programmable Fault Function 30.17 (ACC: 30.11))	The load on the incoming mains system is out of balance. This can be caused by a fault in the motor, motor cable or an internal malfunction.	Check motor. Check motor cable. Check there are no power factor correction capacitors or surge absorbers in the motor cable.
ENCODER ERR	Communication fault between the pulse encoder and the NTAC module or between the NTAC module and the ACS 600.	Check the pulse encoder and its wiring, the NTAC module, Parameter Group 50 settings and the fibre optic connections on NAMC channel CH1.

FAULT	CAUSE	WHAT TO DO
EXTERNAL FLT (programmable Fault Function 30.03)	There is a fault in one of the external devices. (This information is configured through one of the programmable digital inputs.)	Check external devices for faults. Check Parameter 30.03 EXTERNAL FAULT.
ID RUN FAIL	The Motor ID Run is not completed successfully.	Check the maximum speed (Parameter 20.02) It should be at least 80 % of the nominal speed of the motor (Parameter 99.08).
INLET LOW <sup>PFC</sup> (programmable Fault Function 82.01 ... 82.05)	Pressure at pump/fan inlet too low.	Check for a closed valve on the inlet side of the pump/fan. Check piping for leaks.
I/O COMM	A communication error has occurred on the NAMC board, channel CH1.  Electromagnetic interference.  There is an internal fault on the NIOC board.	Check the connections of the fibre optic cables on NAMC channel CH1. Check all I/O modules (if present) connected to channel CH1. Check for proper earthing of the equipment. Check for highly emissive components nearby. Replace the NIOC board.
MOTOR PHASE (programmable Fault Function 30.16 (ACC: 30.10))	One of the motor phases is lost. This can be caused by a fault in the motor, the motor cable, a thermal relay (if used) or an internal fault.	Check motor and motor cable. Check thermal relay (if used). Check MOTOR PHASE Fault Function parameters. Disable this protection.
MOTOR STALL (programmable Fault Function 30.10 ... 30.12)	Motor is operating in the stall region. This can be caused by excessive load or insufficient motor power.	Check motor load and the ACS 600 ratings. Check MOTOR STALL Fault Function parameters.
MOTOR TEMP (programmable Fault Function 30.04 ... 30.09)	Motor temperature is too high (or appears to be too high). This can be caused by excessive load, insufficient motor power, inadequate cooling or incorrect start-up data.	Check motor ratings and load. Check start-up data. Check MOTOR TEMP Fault Function parameters.
NO MOT DATA	Motor data is not given or motor data does not match with inverter data.	Check the motor data given by Parameters 99.04... 99.09.
OUTLET HIGH <sup>PFC</sup> (programmable Fault Function 82.06 ... 82.10)	Pressure at pump/fan outlet too high.	Check piping for blocks.
OVERCURRENT	Output current is excessive. The software overcurrent trip limit is $3.5 \cdot I_{2hd}$ .	Check motor load. Check acceleration time. Check motor and motor cable (including phasing). Check there are no power factor correction capacitors or surge absorbers in the motor cable. Check encoder cable (including phasing).

FAULT	CAUSE	WHAT TO DO
OVERFREQ	<p>Motor is turning faster than the highest allowed speed. This can be caused by an incorrectly set minimum/maximum speed, insufficient braking torque or changes in the load when using torque reference.</p> <p>The trip level is 40 Hz over the operating range absolute maximum speed limit (Direct Torque Control mode active) or frequency limit (Scalar Control active). The operating range limits are set by Parameters 20.01 and 20.02 (DTC mode active) or 20.07 and 20.08 (Scalar Control active), not in PFC.</p>	<p>Check minimum/maximum speed settings.                      Check adequacy of motor braking torque.                      Check applicability of torque control.                      Check the need for a Braking Chopper and Resistor(s).</p>
PANEL LOSS (programmable Fault Function 30.02)	<p>A Control Panel or Drives Window selected as active control location for the ACS 600 has ceased communicating.</p>	<p>Check Control Panel connector.                      Re-insert Control Panel in the mounting platform.                      Check PANEL LOSS Fault Function parameters.                      Check Drives Window connection.</p>
PPCC LINK	<p>The fibre optic link to the NINT board is faulty.</p>	<p>Check the fibre optic cables connected to the power plates.</p>
SHORT CIRC	<p>There is a short-circuit in the motor cable(s) or motor.</p> <p>There output bridge of the converter unit is faulty.</p>	<p>Check the motor and motor cable.                      Check there are no power factor correction capacitors or surge absorbers in the motor cable.</p> <p>Check output semiconductors and current transducers.</p>
START INHIBIT	<p>Optional start inhibit hardware logic is activated.</p>	<p>Check the start inhibit circuit (NGPS board).</p>
SUPPLY PHASE	<p>Intermediate circuit DC voltage is oscillating. This can be caused by a missing mains phase, a blown fuse or a rectifier bridge internal fault.                      A trip occurs when the DC voltage ripple is 13 per cent of the DC voltage.</p>	<p>Check mains fuses.                      Check for mains supply unbalance.</p>
THERMISTOR (programmable Fault Function 30.04 ... 30.05)	<p>Motor thermal protection mode selected as THERMISTOR and the temperature is excessive.</p>	<p>Check motor ratings and load.                      Check start-up data.                      Check thermistor connections for digital input DI6.                      Check thermistor cabling.</p>
UNDERLOAD (programmable Fault Function 30.13 ... 30.15)	<p>Motor load is too low. This can be caused by a release mechanism in the driven equipment.</p>	<p>Check for a problem in the driven equipment.                      Check UNDERLOAD Fault Function parameters.</p>
USER MACRO	<p>There is no User Macro saved or the file is defective.</p>	<p>Create the User Macro again.</p>

# Appendix A – Complete Parameter Settings

The tables in this Appendix list all the actual signals and parameters with their alternative settings of the ACS 600. The numbers in brackets ( ) in the Range/Unit and Alternative Settings columns show the numerical equivalents for fieldbus use.

*Table A-1 Default Signals in the Actual Signal Display Mode of the Control Panel.*

Parameter	PFC Macro Setting	Hand/Auto Setting	Custom Setting
<b>ACTUAL SIGNALS</b>	(three default signals in the actual signal display mode of the control panel)		
	ACT VAL1	FREQ	
	CURRENT	CURRENT	
	FREQ	CTRL LOC	

*Table A-2 Group 1 Actual Signals.*

No.	Signal	Short name	Range/Unit ( ) Fieldbus Equivalent	PROFIBUS Par. No. (Add 4000 in FMS Mode)	Modbus/ Plus Par. No.	Scaling for Fieldbus	Notes
1.01	SPEED	SPEED	rpm	1	40101	-20000 = -100% 20000 = 100%	
1.02	FREQUENCY	FREQ	Hz	2	40102	-100 = -1 Hz 100 = 1 Hz	
1.03	CURRENT	CURRENT	A	3	40103	10 = 1 A	
1.04	TORQUE	TORQUE	%	4	40104	-10000 = -100% 10000 = 100% of motor nominal torque	
1.05	POWER	POWER	%	5	40105	0 = 0% 10000 = 100% of motor nominal power	
1.06	DC BUS VOLTAGE V	DC BUS V	V	6	40106	1 = 1 V	

No.	Signal	Short name	Range/Unit ( ) Fieldbus Equivalent	PROFIBUS Par. No. (Add 4000 in FMS Mode)	Modbus/ Plus Par. No.	Scaling for Fieldbus	Notes
1.07	MAINS VOLTAGE	MAINS V	V	7	40107	1 = 1 V	
1.08	OUTPUT VOLTAGE	OUT VOLT	V	8	40108	1 = 1 V	
1.09	ACS600 TEMP	ACS TEMP	°C	9	40109	1 = 1 °C	
1.10	EXTERNAL REF 1	EXT REF1	Hz	10	40110	100 = 1 Hz	
1.11	EXTERNAL REF 2	EXT REF2	%	11	40111	0 = 0% 10000 = 100% of max. process reference (PFC Macro) or max. frequency (Hand/ Auto Macro)	
1.12	CTRL LOCATION	CTRL LOC	(1,2) LOCAL; (3) EXT1; (4) EXT2	12	40112	(see Range/Unit)	
1.13	OP HOUR COUNTER	OP HOURS	h	13	40113	1 = 1 h	
1.14	KILOWATT HOURS	KW HOURS	kWh	14	40114	1 = 100 kWh	
1.15	APPL BLOCK OUTPUT	APPL OUT	%	15	40115	0 = 0 % 10000 = 100 %	
1.16	DI6-1 STATUS	DI6-1		16	40116		
1.17	AI1 [V]	AI1 [V]	V	17	40117	1 = 0.01 V	
1.18	AI2 [mA]	AI2 [mA]	mA	18	40118	1 = 0.01 mA	
1.19	AI3 [mA]	AI3 [mA]	mA	19	40119	1 = 0.01 mA	
1.20	RO3-1 STATUS	RO3-1		20	40120		
1.21	AO1 [mA]	AO1 [mA]	mA	21	40121	1 = 0.01 mA	
1.22	AO2 [mA]	AO2 [mA]	mA	22	40122	1 = 0.01 mA	
1.23	ACTUAL VALUE 1	ACT VAL1	No; bar; %; C; mg/l; kPa	23	40123	0 = 0 % 10000 = 100 %	
1.24	ACTUAL VALUE 2	ACT VAL2	No; bar; %; C; mg/l; kPa	24	40124	0 = 0 % 10000 = 100 %	
1.25	CONTROL DEVIATION	CONT DEV	%	25	40125	-10000 = -100 % 10000 = 100 %	
1.26	PFC OPERAT. TIME	PFC OPT	h	26	40126	1 = 1 h	
1.27	ACTUAL FUNC OUT	ACTUAL F		27	40127		
1.43	MOTOR RUN-TIME	MOTOR RU	h	43	40143	1 = 10 h	

**Table A-3 Group 2 Actual Signals for speed and torque reference monitoring.**

No.	Signal	Short name	Range/Unit ( ) Fieldbus Equivalent	PROFIBUS Par. No. (Add 4000 in FMS Mode)	Modbus/ Modbus Plus Par. No.	Scaling for Fieldbus
2.01	SPEED REF 2	S REF 2	%	51	40201	0 = 0 % 20000 = 100 % of motor absolute max. speed
2.02	SPEED REF 3	S REF 3	%	52	40202	
2.09	TORQ REF 2	T REF 2	%	59	40209	0 = 0 % 10000 = 100 % of motor nominal torque
2.10	TORQ REF 3	T REF 3	%	60	40210	
2.13	TORQ REF USED	T USED R	%	63	40213	
2.17	SPEED ESTIMATED	SPEED ES	%	67	40217	0 = 0 % 20000 = 100 % of motor absolute max. speed

**Table A-4 Group 3 Actual Signals for fieldbus communication (each signal is a 16-bit data word).**

No.	Signal	Short name	Range/Unit ( ) Fieldbus Equivalent	PROFIBUS Par. No. (Add 4000 in FMS Mode)	Modbus/ Modbus Plus Par. No.	Scaling for Fieldbus
3.01	MAIN CTRL WORD	MAIN CW	0 ... 65535 (Decimal)	76	40301	
3.02	MAIN STATUS WORD	MAIN SW	0 ... 65535 (Decimal)	77	40302	
3.03	AUX STATUS WORD	AUX SW	0 ... 65535 (Decimal)	78	40303	
3.04	LIMIT WORD 1	LIMIT W1	0 ... 65535 (Decimal)	79	40304	
3.05	FAULT WORD 1	FAULT W1	0 ... 65535 (Decimal)	80	40305	
3.06	FAULT WORD 2	FAULT W2	0 ... 65535 (Decimal)	81	40306	
3.07	SYSTEM FAULT	SYS FLT	0 ... 65535 (Decimal)	82	40307	
3.08	ALARM WORD 1	ALARM W 1	0 ... 65535 (Decimal)	83	40308	
3.09	ALARM WORD 2	ALARM W 2	0 ... 65535 (Decimal)	84	40309	

The contents of these data words are detailed in Appendix C – Fieldbus Control.

Table A-5 Parameter Settings.

Parameter	Alternative Settings ( ) Fieldbus Equivalent	PROFIBUS Par. No. (Add 4000 in FMS Mode)	Modbus/ Plus Par. No.	Scaling for Fieldbus	Default Parameter Settings of PFC Macro	Default Parameter Settings of Hand/Auto Macro	Custom Setting
<b>99 START-UP DATA</b>							
99.01 LANGUAGE	(0) ENGLISH; (1) ENGLISH AM; (2) DEUTSCH; (3) ITALIANO; (4) ESPANOL; (5) PORTUGUES; (6) NEDERLANDS; (7) FRANCAIS; (8) DANSK; (9) SUOMI; (10) SVENSKA; (11) CESKY; (12) POLSKI	1926	49901	(see <b>Alternative Settings</b> )	ENGLISH	ENGLISH	
99.02 APPLICATION MACRO	(1) PFC; (2) HAND/AUTO; (3) USER 1 LOAD; (4) USER 1 SAVE; (5) USER 2 LOAD; (6) USER 2 SAVE	1927	49902	(see <b>Alternative Settings</b> )	PFC	HAND/AUTO	
99.03 APPLIC RESTORE	(0) NO; (1) YES	1928	49903	(see <b>Alternative Settings</b> )	NO	NO	
99.04 MOTOR CTRL MODE	(0) DTC; (1) SCALAR	1929	49904	(see <b>Alternative Settings</b> )	DTC	DTC	
99.05 MOTOR NOM VOLTAGE	$1/2 \times U_n$ of ACS 600 ... $2 \times U_n$ of ACS 600 (printed on the motor nameplate)	1930	49905	1 = 1 V	0 V	0 V	
99.06 MOTOR NOM CURRENT	$1/6 \times I_{nld}$ of ACS 600 ... $2 \times I_{nld}$ of ACS 600 (printed on the motor nameplate)	1931	49906	1 = 0.1 A	0.0 A	0.0 A	
99.07 MOTOR NOM FREQ	8 ... 300 Hz (printed on the motor nameplate)	1932	49907	1 = 0.01 Hz	50.0 Hz	50.0 Hz	
99.08 MOTOR NOM SPEED	1 ... 18000 rpm (printed on the motor nameplate)	1933	49908	1 = 1 rpm	1 rpm	1 rpm	
99.09 MOTOR NOM POWER	0 ... 9000 kW (printed on the motor nameplate)	1934	49909	1 = 1 kW	0.0 kW	0.0 kW	
99.10 MOTOR ID RUN	(1) NO; (2) STANDARD; (3) REDUCED	1935	49910	(see <b>Alternative Settings</b> )	NO	NO	
<b>10 START/STOP/DIR</b>							
10.01 EXT1 STRT/STP/DIR	(1) NOT SEL.; (2) DI1; (3) DI1.2; (4) DI1P2P; (5) DI1P2P;3; (6) DI1P2P;3P; (7) DI6; (8) DI6.5; (9) KEYPAD; (10) COMM. MODULE	101	41001	(see <b>Alternative Settings</b> )	DI1	DI1	
10.02 EXT2 STRT/STP/DIR	(1) NOT SEL.; (2) DI1; (3) DI1.2; (4) DI1P2P; (5) DI1P2P;3; (6) DI1P2P;3P; (7) DI6; (8) DI6.5; (9) KEYPAD; (10) COMM. MODULE	102	41002	(see <b>Alternative Settings</b> )	DI6	DI6	
10.03 DIRECTION	(1) FORWARD; (2) REVERSE; (3) REQUEST	103	41003	(see <b>Alternative Settings</b> )	FORWARD	FORWARD	



Parameter	Alternative Settings ( ) Fieldbus Equivalent	PROFIBUS Par No. (Add 4000 in FMS Mode)	Modbus/ Plus Par. No.	Scaling for Fieldbus	Default Parameter Settings of PFC Macro	Default Parameter Settings of Hand/Auto Macro	Custom Setting
<b>11 REFERENCE SELECT</b>							
11.01 KEYPAD REF SEL	(1) REF1(Hz); (2) REF2(%)	126	41101	(see <b>Alternative Settings</b> )	REF1 (Hz)	REF1 (Hz)	
11.02 EXT1/EXT2 SELECT	(1) DI1; (2) DI2; (3) DI3; (4) DI4; (5) DI5; (6) DI6; (7) EXT1; (8) EXT2; (9) COMM. MODULE	127	41102	(see <b>Alternative Settings</b> )	EXT2	DI5	
11.03 EXT REF1 SELECT	(1) KEYPAD; (2) AI1; (3) AI2; (4) AI3; (5) AI1+AI3; (6) AI2+AI3; (7) AI1-AI3; (8) AI2-AI3; (9) AI1*AI3; (10) AI2*AI3; (11) MIN(AI1,AI3); (12) MIN(AI2,AI3); (13) MAX(AI1,AI3); (14) MAX(AI2,AI3); (15) COMM. MODULE	128	41103	(see <b>Alternative Settings</b> )	AI1	AI1	
11.04 EXT REF1 MINIMUM	0 ... 120 Hz	129	41104	1 = 0.01 Hz	0 Hz	0 Hz	
11.05 EXT REF1 MAXIMUM	0 ... 120 Hz	130	41105	1 = 0.01 Hz	52 Hz	52 Hz	
11.06 EXT REF2 SELECT	(1) KEYPAD; (2) AI1; (3) AI2; (4) AI3; (5) AI1+AI3; (6) AI2+AI3; (7) AI1-AI3; (8) AI2-AI3; (9) AI1*AI3; (10) AI2*AI3; (11) MIN(AI1,AI3); (12) MIN(AI2,AI3); (13) MAX(AI1,AI3); (14) MAX(AI2,AI3); (15) COMM. MODULE	131	41106	(see <b>Alternative Settings</b> )	AI1	AI2	
11.07 EXT REF2 MINIMUM	0 ... 100%	132	41107	0 = 0% 10000 = 100%	0%	0%	
11.08 EXT REF2 MAXIMUM	0 ... 500%	133	41108	0 = 0% 5000 = 500%	100%	100%	
<b>12 CONSTANT FREQ</b>							
12.01 CONST FREQ SEL	(1) NOT SEL; (2) DI4 (FREQ1); (3) DI5 (FREQ2); (4) DI4,5	151	41201	(see <b>Alternative Settings</b> )	NOT SEL	NOT SEL	
12.02 CONST FREQ 1	0 ... 120 Hz	152	41202	1 = 0.01 Hz	25 Hz	25 Hz	
12.03 CONST FREQ 2	0 ... 120 Hz	153	41203		30 Hz	30 Hz	
12.04 CONST FREQ 3	0 ... 120 Hz	154	41204		35 Hz	35 Hz	
<b>13 ANALOGUE INPUTS</b>							
13.01 MINIMUM AI1	(1) 0 V; (2) 2 V; (3) TUNED VALUE; (4) TUNE	176	41301	(see <b>Alternative Settings</b> )	0 V	0 V	
13.02 MAXIMUM AI1	(1) 10 V; (2) TUNED VALUE; (3) TUNE	177	41302	(see <b>Alternative Settings</b> )	10 V	10 V	
13.03 SCALE AI1	0 ... 100%	178	41303	0 = 0% 10000 = 100%	100%	100%	
13.04 FILTER AI1	0.00 ... 10.00 s	179	41304	0 = 0 s 1000 = 10 s	0.10 s	0.10 s	
13.05 INVERT AI1	(0) NO; (65535) YES	180	41305	(see <b>Alternative Settings</b> )	NO	NO	
13.06 MINIMUM AI2	(1) 0 mA; (2) 4 mA; (3) TUNED VALUE; (4) TUNE	181	41306	(see <b>Alternative Settings</b> )	4 mA	4 mA	

Parameter	Alternative Settings ( ) Fieldbus Equivalent	PROFIBUS Par. No. (Add 4000 in FMS Mode)	Modbus/ Par. No.	Scaling for Fieldbus	Default Parameter Settings of PFC Macro	Default Parameter Settings of Hand/Auto Macro	Custom Setting
13.07 MAXIMUM AI2	(1) 20 mA; (2) TUNED VALUE; (3) TUNE	182	41307	(see Alternative Settings)	20 mA	20 mA	
13.08 SCALE AI2	0 ... 100%	183	41308	0 = 0% 10000 = 100%	100%	100%	
13.09 FILTER AI2	0.00 ... 10.00 s	184	41309	0 = 0 s 1000 = 10 s	0.10 s	0.10 s	
13.10 INVERT AI2	(0) NO; (65535) YES	185	41310	(see Alternative Settings)	NO	NO	
13.11 MINIMUM AI3	(1) 0 mA; (2) 4 mA; (3) TUNED VALUE; (4) TUNE	186	41311	(see Alternative Settings)	4 mA	4 mA	
13.12 MAXIMUM AI3	(1) 20 mA; (2) TUNED VALUE; (3) TUNE	187	41312	(see Alternative Settings)	20 mA	20 mA	
13.13 SCALE AI3	0 ... 100%	188	41313	0 = 0% 10000 = 100%	100%	100%	
13.14 FILTER AI3	0.00 ... 10.00 s	189	41314	0 = 0 s 1000 = 10 s	0.10 s	0.10 s	
13.15 INVERT AI3	(0) NO; (65535) YES	190	41315	(see Alternative Settings)	NO	NO	
<b>14 RELAY OUTPUTS</b>							
14.01 RELAY RO1 OUTPUT	Relay_output 1: (1) M1 START; Relay_output 2: (1) M2 START; Relay_output 3: (1) M3 START;	201	41401	(see Alternative Settings)	M1 START	READY	
14.02 RELAY RO2 OUTPUT	Relay_output 1, 2 & 3: (2) NOT USED; (3) READY; (4) RUNNING; (5) FAULT; (6) FAULT(-1); (7) FAULT(RST); (8) STALL WARN; (9) STALL FLT; (10) MOT TEMP WRN; (11) MOT TEMP FLT; (12) ACS TEMP WRN; (13) ACS TEMP FLT; (14) FAULT/WARN; (15) WARNING; (16) REVERSED; (17) EXT CTRL; (18) REF2 SEL; (19) DC OVERVOLT; (20) DC UNDERVOLT; (21) FREQ 1 LIM; (22) FREQ 2 LIM; (23) CURRENT LIM; (24) REF 1 LIM; (25) REF 2 LIM; (26) STARTED; (27) LOSS OF REF; (28) AT SPEED;	202	41402		M2 START	RUNNING	
14.03 RELAY RO3 OUTPUT	Relay_output 1 & 2: (29) ACT 1 LIM; (30) ACT 2 LIM; (31) COMM. MODULE; (32) INLET LOW; (33) OUTLET HIGH; (34) PROFILE HIGH Relay_output 3: (29) MAGN READY; (30) USER 2 SEL (31) COMM. MODULE; (32) INLET LOW; (33) OUTLET HIGH; (34) PROFILE HIGH	203	41403		FAULT	FAULT(-1)	
14.04 EXT2 REL OUTPUT1	(1) READY; (2) RUNNING; (3) FAULT; (4) FAULT(-1); (5) FREQ 1 LIM; (6) ACT 1 LIM; (7) INLET LOW; (8) OUTLET HIGH; (9) PROFILE HIGH	204	41404		RUNNING	RUNNING	
14.05 EXT2 REL OUTPUT2	(1) READY; (2) RUNNING; (3) FAULT; (4) FAULT(-1); (5) FREQ 2 LIM; (6) ACT 2 LIM; (7) INLET LOW; (8) OUTLET HIGH; (9) PROFILE HIGH	205	41405		FAULT	FAULT	

Parameter	Alternative Settings ( ) Fieldbus Equivalent	PROFIBUS Par. No. (Add 4000 in FMS Mode)	Modbus/ Plus Par. No.	Scaling for Fieldbus	Default Parameter Settings of PFC Macro	Default Parameter Settings of Hand/Auto Macro	Custom Setting
<b>15 ANALOGUE OUTPUTS</b>							
15.01 ANALOGUE OUTPUT1	(1) NOT USED; (2) SPEED; (3) FREQUENCY; (4) CURRENT; (5) TORQUE; (6) POWER; (7) DC BUS VOLT; (8) OUTPUT VOLT; (9) REFERENCE; (10) CONTROL DEV.; (11) ACTUAL 1; (12) ACTUAL 2; (13) PICON OUTP.; (14) PICON REF; (15) ACTUAL FUNC; (16) COMM. MODULE	226	41501	(see <b>Alternative Settings</b> )	FREQUENCY	FREQUENCY	
15.02 INVERT AO1	(0) NO; (65535) YES	227	41502	(see <b>Alternative Settings</b> )	NO	NO	
15.03 MINIMUM AO1	(1) 0 mA; (2) 4 mA	228	41503	(see <b>Alternative Settings</b> )	0 mA	0 mA	
15.04 FILTER AO1	0.00 ... 10.00 s	229	41504	0 = 0 s 1000 = 10 s	2.00 s	2.00 s	
15.05 SCALE AO1	10 ... 1000%	230	41505	100 = 10% 10000 = 10000%	100%	100%	
15.06 ANALOGUE OUTPUT2	(1) NOT USED; (2) SPEED; (3) FREQUENCY; (4) CURRENT; (5) TORQUE; (6) POWER; (7) DC BUS VOLT; (8) OUTPUT VOLT; (9) REFERENCE; (10) CONTROL DEV.; (11) ACTUAL 1; (12) ACTUAL 2; (13) PICON OUTP.; (14) PICON REF; (15) ACTUAL FUNC; (16) COMM. MODULE	231	41506	(see <b>Alternative Settings</b> )	ACTUAL 1	CURRENT	
15.07 INVERT AO2	(0) NO; (65535) YES	232	41507	(see <b>Alternative Settings</b> )	NO	NO	
15.08 MINIMUM AO2	(1) 0 mA; (2) 4 mA	233	41508	(see <b>Alternative Settings</b> )	0 mA	0 mA	
15.09 FILTER AO2	0.00 ... 10.00 s	234	41509	0 = 0 s 1000 = 10 s	2.00 s	2.00 s	
15.10 SCALE AO2	10 ... 1000%	235	41510	100 = 10% 10000 = 10000%	100%	100%	
<b>16 SYSTEM CTR INPUTS</b>							
16.01 RUN ENABLE	(1) YES; (2) DI1; (3) DI2; (4) DI3; (5) DI4; (6) DI5; (7) DI6; (8) COMM. MODULE	251	41601	(see <b>Alternative Settings</b> )	YES	YES	
16.02 PARAMETER LOCK	(0) OPEN; (65535) LOCKED	252	41602	(see <b>Alternative Settings</b> )	OPEN	OPEN	
16.03 PASS CODE	0 ... 30000	253	41603		0	0	
16.04 FAULT RESET SEL	(1) NOT SEL.; (2) DI1; (3) DI2; (4) DI3; (5) DI4; (6) DI5; (7) DI6; (8) ON STOP; (9) COMM. MODULE	254	41604	(see <b>Alternative Settings</b> )	NOT SEL	NOT SEL	
16.05 USER MACRO IO CHG	(1) NOT SEL.; (2) DI1; (3) DI2; (4) DI3; (5) DI4; (6) DI5; (7) DI6	255	41605	(see <b>Alternative Settings</b> )	NOT SEL	NOT SEL	

Parameter	Alternative Settings ( ) Fieldbus Equivalent	PROFIBUS Par. No. (Add 4000 in FMS Mode)	Modbus/ Modbus Plus Par. No.	Scaling for Fieldbus	Default Parameter Settings of PFC Macro	Default Parameter Settings of Hand/Auto Macro	Custom Setting
16.06 LOCAL LOCK	(0) OFF; (65535) ON	256	41606	(see Alternative Settings)	OFF	OFF	
16.07 PARAMETER SAVE	(0) DONE; (1) SAVE..	257	41607	(see Alternative Settings)	DONE	DONE	
<b>20 LIMITS</b>							
20.01 MINIMUM FREQ	-120 ... 120 Hz	351	42001	1 = 0.01 Hz	0.00 Hz	0.00 Hz	
20.02 MAXIMUM FREQ	-120 ... 120 Hz	352	42002	1 = 0.01 Hz	52.00 Hz	52.00 Hz	
20.03 MAXIMUM CURRENT	0.0% $I_{hd}$ ... 200.0% $I_{hd}$	353	42003	0 = 0% 20000 = 200%	200.0% $I_{hd}$	200.0% $I_{hd}$	
20.04 MAXIMUM TORQUE	0.0 ... 300.0%	354	42004	100 = 1%	300.0%	300.0%	
20.05 OVERVOLTAGE CTRL	(0) NO; (65535) YES	355	42005	(see Alternative Settings)	ON	ON	
20.06 UNDERVOLTAGE CTRL	(0) NO; (65535) YES	356	42006	(see Alternative Settings)	ON	ON	
20.11 P MOTORING LIM	0.0 ... 600.0%	361	42011	100 = 1%	300.0%	300.0%	
20.12 P GENERATING LIM	-600.0 ... 0.0%	362	42012	100 = 1%	-300.0%	-300.0%	
<b>21 START/STOP</b>							
21.01 START FUNCTION	(1) AUTO; (2) DC MAGN; (3) CNST DC MAGN	376	42101	(see Alternative Settings)	AUTO	AUTO	
21.02 CONST MAGN TIME	30.0 ... 10000.0 ms	377	42102	1 = 1 ms	300.0 ms	300.0 ms	
21.03 STOP FUNCTION	(1) COAST; (2) RAMP	378	42103	(see Alternative Settings)	COAST	COAST	
21.08 SCALAR FLYSTART	(0) OFF; (65535) ON	383	42108	(see Alternative Settings)	OFF	OFF	
<b>22 ACCEL/DECEL</b>							
22.01 ACC/DEC 1/2 SEL	(1) ACC/DEC 1; (2) ACC/DEC 2; (3) DI1; (4) DI2; (5) DI3; (6) DI4; (7) DI5; (8) DI6	401	42201	(see Alternative Settings)	ACC/DEC 1	ACC/DEC 1	
22.02 ACCEL TIME 1	0.00 ... 1800.00 s	402	42202	0 = 0 s 18000 = 1800 s	3.00 s	3.00 s	
22.03 DECEL TIME 1	0.00 ... 1800.00 s	403	42203		3.00 s	3.00 s	
22.04 ACCEL TIME 2	0.00 ... 1800.00 s	404	42204		60.00 s	60.00 s	
22.05 DECEL TIME 2	0.00 ... 1800.00 s	405	42205		60.00 s	60.00 s	
22.06 ACC/DEC RAMP SHPE	0.00 ... 1000.00 s	406	42206	100 = 1 s	0.00 s	0.00 s	
22.07 EM STOP RAMP TIME	0.00 ... 1999.97 s	407	42207	100 = 1 s	3.00 s	3.00 s	

Parameter	Alternative Settings ( ) Fieldbus Equivalent	PROFIBUS Par. No. (Add 4000 in FMS Mode)	Modbus/ Plus Par. No.	Scaling for Fieldbus	Default Parameter Settings of Hand/Auto Macro	Default Parameter Settings of PFC Macro	Custom Setting
<b>23 SPEED CTRL</b>	(VISIBLE ONLY WHEN THE DTC MOTOR CONTROL MODE IS SELECTED.)						
23.01 GAIN	0.0 ... 200.0	426	42301	0 = 0 10000 = 100	10.0	10.0	
23.02 INTEGRATION TIME	0.01 ... 999.98 s	427	42302	1000 = 1 s	2.50 s	2.50 s	
23.03 SLIP GAIN	0.0 ... 400.0%	430	42305	1 = 1%	100.0%	100.0%	
<b>25 CRITICAL FREQ</b>							
25.01 CRIT FREQ SELECT	(0) OFF; (65535) ON	476	42501	(see <b>Alternative Settings</b> )	OFF	OFF	
25.02 CRIT FREQ 1 LOW	0 ... 120 Hz	477	42502	1 = 0.01 Hz	0 Hz	0 Hz	
25.03 CRIT FREQ 1 HIGH	0 ... 120 Hz	478	42503		0 Hz	0 Hz	
25.04 CRIT FREQ 2 LOW	0 ... 120 Hz	479	42504		0 Hz	0 Hz	
25.05 CRIT FREQ 2 HIGH	0 ... 120 Hz	480	42505		0 Hz	0 Hz	
<b>26 MOTOR CONTROL</b>							
26.01 FLUX OPTIMIZATION	(0) NO; (65535) YES	501	42601	(see <b>Alternative Settings</b> )	NO	NO	
26.02 FLUX BRAKING	(0) NO; (65535) YES (visible only when the DTC motor control mode is selected)	502	42602	(see <b>Alternative Settings</b> )	YES	YES	
26.03 IR COMPENSATION	0.0 ... 30.0% (visible only when the scalar motor control mode is selected)	503	42603	100 = 1%	0.0%	0.0%	
26.04 HEX FIELD WEAKEN	(0) OFF; (65535) ON	504	42604	(see <b>Alternative Settings</b> )	OFF	OFF	
<b>30 FAULT FUNCTIONS</b>							
30.01 AI<MIN FUNCTION	(1) FAULT; (2) NO; (3) PRESET FREQ; (4) LAST FREQ	601	43001	(see <b>Alternative Settings</b> )	FAULT	FAULT	
30.02 PANEL LOSS	(1) FAULT; (2) PRESET FREQ; (3) LAST FREQ	602	43002	(see <b>Alternative Settings</b> )	FAULT	FAULT	
30.03 EXTERNAL FAULT	(1) NOT SEL; (2) DI1; (3) DI2; (4) DI3; (5) DI4; (6) DI5; (7) DI6	603	43003	(see <b>Alternative Settings</b> )	NOT SEL	NOT SEL	
30.04 MOTOR THERM PROT	(1) FAULT; (2) WARNING; (3) NO	604	43004	(see <b>Alternative Settings</b> )	NO	NO	
30.05 MOT THERM P MODE	(1) DTC; (2) USER MODE; (3) THERMISTOR	605	43005	(see <b>Alternative Settings</b> )	DTC	DTC	
30.06 MOTOR THERM TIME	256.0 ... 9999.8 s	606	43006	1 = 1 s	(calculated)	(calculated)	
30.07 MOTOR LOAD CURVE	50.0 ... 150.0%	607	43007	1 = 1%	100.0%	100.0%	
30.08 ZERO SPEED LOAD	25.0 ... 150.0%	608	43008	1 = 1%	74.0%	74.0%	

Parameter	Alternative Settings ( ) Fieldbus Equivalent	PROFIBUS Par. No. (Add 4000 in Modbus Plus)	Modbus/ Modbus Plus Par. No.	Scaling for Fieldbus	Default Parameter Settings of PFC Macro	Default Parameter Settings of Hand/Auto Macro	Custom Setting
30.09 BREAK POINT	1.0 ... 300.0 Hz	609	43009	100 = 1 Hz 30000 = 300 Hz	45.0 Hz	45.0 Hz	
30.10 STALL FUNCTION	(1) FAULT; (2) WARNING; (3) NO	610	43010	(see <b>Alternative Settings</b> )	FAULT	FAULT	
30.11 STALL FREQ HI	0.5 ... 50.0 Hz	611	43011	50 = 0.5 Hz 5000 = 50 Hz	20.0 Hz	20.0 Hz	
30.12 STALL TIME	10.00 ... 400.00 s	612	43012	1 = 1 s	20.00 s	20.00 s	
30.13 UNDERLOAD FUNC	(1) NO; (2) WARNING; (3) FAULT	613	43013	(see <b>Alternative Settings</b> )	NO	NO	
30.14 UNDERLOAD TIME	0 ... 600 s	614	43014	1 = 1 s	600 s	600 s	
30.15 UNDERLOAD CURVE	1 ... 5	615	43015	(see <b>Alternative Settings</b> )	1	1	
30.16 MOTOR PHASE LOSS	(0) NO; (65535) FAULT (visible only when the DTC motor control mode is selected)	616	43016	(see <b>Alternative Settings</b> )	NO	NO	
30.17 EARTH FAULT	(0) NO; (65535) FAULT	617	43017	(see <b>Alternative Settings</b> )	FAULT	FAULT	
30.18 PRESET FREQ	0 ... 120.0 Hz	618	43018	1 = 0.01 Hz	10.00 Hz	10.00 Hz	
30.19 COMM FAULT FUNC	(1) FAULT; (2) NO; (3) PRESET FREQ; (4) LAST FREQ (visible only with a communication module active)	619	43019	(see <b>Alternative Settings</b> )	FAULT	FAULT	
30.20 COMM FAULT TIMEOUT	0.10 ... 60.00 s (visible only with a communication module active)	620	43020	10 = 0.1 s 6000 = 60 s	1.00 s	1.00 s	
30.21 COMM FAULT RO/AO	(0) ZERO; (65535) LAST VALUE (visible only with a communication module active)	621	43021	(see <b>Alternative Settings</b> )	ZERO	ZERO	
<b>31 AUTOMATIC RESET</b>							
31.01 NUMBER OF TRIALS	0 ... 5	626	43101		0	0	
31.02 TRIAL TIME	1.0 ... 180.0 s	627	43102	100 = 1 s 18000 = 180 s	30.0 s	30.0 s	
31.03 DELAY TIME	0.0 ... 3.0 s	628	43103	0 = 0 s 300 = 3 s	0.0 s	0.0 s	
31.04 OVERCURRENT	(0) NO; (65535) YES	629	43104	(see <b>Alternative Settings</b> )	NO	NO	
31.05 OVERVOLTAGE	(0) NO; (65535) YES	630	43105	(see <b>Alternative Settings</b> )	NO	NO	
31.06 UNDERVOLTAGE	(0) NO; (65535) YES	631	43106	(see <b>Alternative Settings</b> )	NO	NO	
31.07 AI SIGNAL<MIN	(0) NO; (65535) YES	632	43107	(see <b>Alternative Settings</b> )	NO	NO	

Parameter	Alternative Settings ( ) Fieldbus Equivalent	PROFIBUS Par. No. (Add 4000 in FMS Mode)	Modbus Plus Par. No.	Scaling for Fieldbus	Default Parameter Settings of PFC Macro	Default Parameter Settings of Hand/Auto Macro	Custom Setting
<b>32 SUPERVISION</b>							
32.01 FREQ1 FUNCTION	(1) NO; (2) LOW LIMIT; (3) HIGH LIMIT; (4) ABS LOW LIMIT	651	43201	(see <b>Alternative Settings</b> )	NO	NO	
32.02 FREQ1 LIMIT	-120 ... 120 Hz	652	43202	1 = 0.01 Hz	0 Hz	0 Hz	
32.03 FREQ2 FUNCTION	(1) NO; (2) LOW LIMIT; (3) HIGH LIMIT; (4) ABS LOW LIMIT	653	43203	(see <b>Alternative Settings</b> )	NO	NO	
32.04 FREQ2 LIMIT	-120 ... 120 Hz	654	43204	1 = 0.01 Hz	0 Hz	0 Hz	
32.05 CURRENT FUNCTION	(1) NO; (2) LOW LIMIT; (3) HIGH LIMIT	655	43205	(see <b>Alternative Settings</b> )	NO	NO	
32.06 CURRENT LIMIT	0 ... 1000 A	656	43206	1 = 1 A	0 A	0 A	
32.07 REF1 FUNCTION	(1) NO; (2) LOW LIMIT; (3) HIGH LIMIT	661	43211	(see <b>Alternative Settings</b> )	NO	NO	
32.08 REF1 LIMIT	0 ... 120 Hz	662	43212	1 = 0.01 Hz	0 Hz	0 Hz	
32.09 REF2 FUNCTION	(1) NO; (2) LOW LIMIT; (3) HIGH LIMIT	663	43213	(see <b>Alternative Settings</b> )	NO	NO	
32.10 REF2 LIMIT	0 ... 500%	664	43214	10 = 1%	0%	0%	
32.11 ACT1 FUNCTION	(1) NO; (2) LOW LIMIT; (3) HIGH LIMIT	665	43215	(see <b>Alternative Settings</b> )	NO	NO	
32.12 ACT1 LIMIT	0 ... 200%	666	43216	0 = 0% 10 = 1%	0%	0%	
32.13 ACT2 FUNCTION	(1) NO; (2) LOW LIMIT; (3) HIGH LIMIT	667	43217	(see <b>Alternative Settings</b> )	NO	NO	
32.14 ACT2 LIMIT	0 ... 200%	668	43218	0 = 0% 10 = 1%	0%	0%	
<b>33 INFORMATION</b>							
33.01 SOFTWARE VERSION	(Version of the ACS 600 software)	676	43301	(Version )	(Version )	(Version )	
33.02 APPL SW VERSION	(Version of the ACS 600 application software)	677	43302	(Version )	(Version )	(Version )	
33.03 TEST DATE	(Date Tested)	678	43303	(Date)	(Date)	(Date)	
<b>51 COMM MOD DATA</b>							
	(VISIBLE ONLY WITH A COMMUNICATION MODULE ACTIVE. SEE MODULE MANUAL.)	1026 ...	45101 ...				
<b>52 STANDARD MODBUS</b>							
52.01 STATION NUMBER	1 ... 247	1051	45201	(see <b>Alternative Settings</b> )	1	1	
52.02 BAUDRATE	(1) 600; (2) 1200; (3) 2400; (4) 4800; (5) 9600; (6) 19200	1052	45202	(see <b>Alternative Settings</b> )	9600	9600	
52.03 PARITY	(1) NONE 1STOPBIT; (2) NONE 2STOPBIT; (3) ODD; (4) EVEN	1053	45203	(see <b>Alternative Settings</b> )	ODD	ODD	

Parameter	Alternative Settings ( ) Fieldbus Equivalent	PROFIBUS Par. No. (Add 4000 in FMS Mode)	Modbus/ Modbus Plus Par. No.	Scaling for Fieldbus	Default Parameter Settings of PFC Macro	Default Parameter Settings of Hand/Auto Macro	Custom Setting
<b>70 DDCS CONTROL</b>							
70.01 CHANNEL 0 ADDR	1 ... 125	1375	47001		1	1	
70.02 CHANNEL 3 ADDR	1 ... 254	1376	47002		1	1	
<b>80 PI CONTROL</b>							
(VISIBLE ONLY WHEN THE PFC MACRO IS SELECTED.)							
80.01 PI GAIN	0.1 ... 100.0		48001		2.5	N/A	
80.02 PI INTEG TIME	0.50 ... 1000.00 s		48002		3.00 s	N/A	
80.03 ERROR VALUE INV	(0) NO; (65535) YES		48003		NO	N/A	
80.04 ACTUAL VALUE SEL	(1) ACT1; (2) ACT1 - ACT2; (3) ACT1 + ACT2; (4) ACT1 * ACT2; (5) ACT1 / ACT2; (6) MIN(A1,A2); (7) MAX(A1,A2);(8) sqrt(A1 - A2); (9) sqA1 + sqA2		48004		ACT1	N/A	
80.05 ACTUAL1 INPUT SEL	(1) NO; (2) A11; (3) A12; (4) A13		48005		A12	N/A	
80.06 ACTUAL2 INPUT SEL	(1) NO; (2) A11; (3) A12; (4) A13		48006		A13	N/A	
80.07 ACT1 MINIMUM	-1000 ... 1000 %		48007		0 %	N/A	
80.08 ACT1 MAXIMUM	-1000 ... 1000 %		48008		100 %	N/A	
80.09 ACT2 MINIMUM	-1000 ... 1000 %		48009		0 %	N/A	
80.10 ACT2 MAXIMUM	-1000 ... 1000 %		48010		100 %	N/A	
80.11 ACT1 UNIT SCALE	-999999 ... 999999		48011		0.10	N/A	
80.12 ACTUAL 1 UNIT	(1) NO; (2) bar; (3) %; (4) C; (5) mg/l; (6) kPa		48012		bar	N/A	
80.13 ACT2 UNIT SCALE	-99999.98 ... 99999.98		48013		0.10	N/A	
80.14 ACTUAL 2 UNIT	(1) NO; (2) bar; (3) %; (4) C; (5) mg/l; (6) kPa		48014		bar	N/A	
80.15 ACTUAL FUNC SCALE	-999999 ... 999999		48015		0.10	N/A	
<b>81 PFC CONTROL</b>							
(VISIBLE ONLY WHEN THE PFC MACRO IS SELECTED.)							
81.01 SET POINT	(0) PANEL; (65535) EXTERNAL		48101		EXTERNAL	N/A	
81.02 CONST SET POINT	0.0 ... 100.0%		48102		40.0%	N/A	
81.03 REFERENCE STEP 1	0.0 ... 100.0%		48103		0.0%	N/A	
81.04 REFERENCE STEP 2	0.0 ... 100.0%		48104		0.0%	N/A	
81.05 REFERENCE STEP 3	0.0 ... 100.0%		48105		0.0%	N/A	
81.06 SLEEP DELAY	0.0 ... 3600.0 s		48106		60.0 s	N/A	



Parameter	Alternative Settings ( ) Fieldbus Equivalent	PROFIBUS Par. No. (Add 4000 in FMS Mode)	Modbus Plus Par. No.	Scaling for Fieldbus	Default Parameter Settings of PFC Macro	Default Parameter Settings of Hand/Auto Macro	Custom Setting
81.07 SLEEP LEVEL	0.0 ... 120.0 Hz		48107		0.0 Hz	N/A	
81.08 WAKE UP LEVEL	0.0 ... 100.0% of the used process reference signal		48108		0.0%	N/A	
81.09 START FREQ 1	0.0 ... 120.0 Hz		48109		50.0 Hz	N/A	
81.10 START FREQ 2	0.0 ... 120.0 Hz		48110		50.0 Hz	N/A	
81.11 START FREQ 3	0.0 ... 120.0 Hz		48111		50.0 Hz	N/A	
81.12 LOW FREQ 1	0.0 ... 120.0 Hz		48112		25.0 Hz	N/A	
81.13 LOW FREQ 2	0.0 ... 120.0 Hz		48113		25.0 Hz	N/A	
81.14 LOW FREQ 3	0.0 ... 120.0 Hz		48114		25.0 Hz	N/A	
81.15 AUX MOT START DLY	0.0 ... 3600.0 s		48115		5.0 s	N/A	
81.16 AUX MOT STOP DLY	0.0 ... 3600.0 s		48116		3.0 s	N/A	
81.17 NBR OF AUX MOTORS	(1) ZERO; (2) ONE; (3) TWO; (4) THREE; (5) FOUR		48117		ONE	N/A	
81.18 AUTOCHANGE INTERV	0 h 0 min ... 336 h 0 min (= 14 days)		48118	0 to 20160 min (= 14 days)	0 h 00 min	N/A	
81.19 AUTOCHANGE LEVEL	0.0 ... 100.0%		48119		0.0%	N/A	
81.20 INTERLOCKS	(0) ON; (65535) OFF		48120		ON	N/A	
81.21 REGUL BYPASS CTRL	(0) YES; (65535) NO		48121		NO	N/A	
81.22 PFC START DELAY	0 ... 10000 ms		48122		500 ms	N/A	
81.23 REFERENCE STEP 4	0.0 ... 100.0% (visible only when Par. 81.17 = FOUR)		48123		0.0%	N/A	
81.24 START FREQ 4	0.0 ... 120.0 Hz (visible only when Par. 81.17 = FOUR)		48124		50.0 Hz	N/A	
81.25 LOW FREQ 4	0.0 ... 120.0 Hz (visible only when Par. 81.17 = FOUR)		48125		25.0 Hz	N/A	
81.26 SLEEP SELECTION	(1) OFF; (2) INTERNAL; (3) DI1; (4) DI2; (5) DI3; (6) DI4; (7) DI5; (8) DI6; (9) EXT DI1; (10) EXT DI2		48126		INTERNAL	N/A	
<b>82 PRESSURE CTRL</b>							
82.01 INPUT PROT CTRL	(1) NOT SEL; (2) WARNING; (3) PROTECT; (4) FAULT		48201		NOT SEL	NOT SEL	
82.02 AI MEASURE INLET	(1) NOT USED; (2) AI1; (3) AI2; (4) AI3; (5) EXT AI1; (6) EXT AI2		48202		NOT USED	NOT USED	
82.03 AI LOW LEVEL	0.0 ... 100.0%		48203		0.0%	0.0%	
82.04 DI STATUS INLET	(1) NOT USED; (2) DI1; (3) DI2; (4) DI3; (5) DI4; (6) DI5; (7) DI6; (8) EXT DI1; (9) EXT DI2		48204		NOT USED	NOT USED	
82.05 INPUT CTRL DLY	0 ... 60 s		48205		0 s	0 s	

Parameter	Alternative Settings ( ) Fieldbus Equivalent	PROFIBUS Par. No. (Add 4000 in FMS Mode)	Modbus Plus Par. No.	Scaling for Fieldbus	Default Parameter Settings of PFC Macro	Default Parameter Settings of Hand/Auto Macro	Custom Setting
82.06 OUTPUT PROT CTRL	(1) NOT SEL.; (2) WARNING; (3) PROTECT; (4) FAULT		48206		NOT SEL	NOT SEL	
82.07 AI MEASURE OUTLET	(1) NOT USED; (2) AI1; (3) AI2; (4) AI3; (5) EXT AI1; (6) EXT AI2		48207		NOT USED	NOT USED	
82.08 AI HIGH LEVEL	0.0 ... 100.0%		48208		0.0%	0.0%	
82.09 DI STATUS OUTLET	(1) NOT USED; (2) DI1; (3) DI2; (4) DI3; (5) DI4; (6) DI5; (7) DI6; (8) EXT DI1; (9) EXT DI2		48209		NOT USED	NOT USED	
82.10 OUTPUT CTRL DLY	0 ... 60 s		48210		0 s	0 s	
82.11 PI REF DEC TIME	0.01 ... 3600.00 s		48211		1.00 s	1.00 s	
82.12 APPL PROFILE CTRL	(1) CONTROL DEV; (2) APPL OUTPUT		48212		APPL OUTPUT	APPL OUTPUT	
82.13 PROFILE OUTP LIM	0 ... 500%		48213		100%	100%	
82.14 PROF LIMIT ON DLY	0.0 ... 100.0 h		48214		0.0 h	0.0 h	
<b>90 D SET REC ADDR</b>	(VISIBLE ONLY WITH A COMMUNICATION MODULE ACTIVE.)						
90.01 AUX DS REF3	0 ... 8999 (Format: (X)YY, where (X)X = Parameter Group, YY = Parameter Index)		49001	(see Alternative Settings)	0	0	
90.02 AUX DS REF4	0 ... 8999 (Format: (X)YY, where (X)X = Parameter Group, YY = Parameter Index)		49002	(see Alternative Settings)	0	0	
90.03 AUX DS REF5	0 ... 8999 (Format: (X)YY, where (X)X = Parameter Group, YY = Parameter Index)		49003	(see Alternative Settings)	0	0	
90.04 MAIN DS SOURCE	1 ... 255		49004	(see Alternative Settings)	1	1	
90.05 AUX DS SOURCE	1 ... 255		49005	(see Alternative Settings)	3	3	
<b>92 D SET TR ADDR</b>	(VISIBLE ONLY WITH A COMMUNICATION MODULE ACTIVE.)						
92.01 MAIN DS STATUS WORD	Fixed to 302 (Actual Signal 3.02 MAIN STATUS WORD)	1771	49201	(see Alternative Settings)	302 (fixed)	302 (fixed)	
92.02 MAIN DS ACT1	0 ... 9999 (Format: (X)YY, where (X)X = Parameter Group, YY = Parameter Index)	1772	49202	(see Alternative Settings)	102	102	
92.03 MAIN DS ACT2	0 ... 9999 (Format: (X)YY, where (X)X = Parameter Group, YY = Parameter Index)	1773	49203	(see Alternative Settings)	105	105	
92.04 MAIN DS ACT3	0 ... 9999 (Format: (X)YY, where (X)X = Parameter Group, YY = Parameter Index)	1774	49204	(see Alternative Settings)	305	305	

Parameter	Alternative Settings ( ) Fieldbus Equivalent	PROFIBUS Par. No. (Add 4000 in FMS Mode)	Modbus/ Plus Par. No.	Scaling for Fieldbus	Default Parameter Settings of PFC Macro	Default Parameter Settings of Hand/Auto Macro	Custom Setting
92.05 MAIN DS ACT4	0 ... 9999 (Format: (X)XY, where (X)X = Parameter Group, YY = Parameter Index)	1775	49205	(see Alternative Settings)	308	308	
92.06 MAIN DS ACT5	0 ... 9999 (Format: (X)XY, where (X)X = Parameter Group, YY = Parameter Index)	1776	49206	(see Alternative Settings)	306	306	
<b>98 OPTION MODULES</b>							
98.01 DI/O PFC EXT	(0) NO; (65535) YES	1901	49801	(see Alternative Settings)	NO	NO	
98.02 COMM. MODULE LINK	(1) NO; (2) FIELDBUS; (3) ADVANT; (4) STD MODBUS; (5) CUSTOMISED	1902	49802	(see Alternative Settings)	NO	NO	
98.03 DI/O EXT MODULE 2	(0) NO; (65535) YES	1903	49803	(see Alternative Settings)	NO	NO	
98.04 AI/O EXT MODULE	(1) NO; (2) NAI0-01; (3) NAI0-02	1904	49804	(see Alternative Settings)	NO	NO	
98.05 COMM INTERFACE	(0) ABB DRIVES; (65535) CSA 2.8/3.0 (visible only with a communication module active)	1905	49805	(see Alternative Settings)	ABB DRIVES	ABB DRIVES	



## ***Appendix B – PFC Application Example***

---

### ***Overview***

In this appendix an existing two-pump PFC application is briefly presented by means of circuit diagrams:

- main circuit diagram (page B-3)
- control circuit diagram (page B-4)
- connection diagram (page B-5)

The pumps are used for pressure boosting. Alternation and a sleep function are used. The application also includes the following additional features:

- Manual control switches for selection between conventional PFC control and direct-on-line (DOL) connection of the motors (S1, S2).  
The switches are of the three-position type:  
A = PFC control in use.  
O = Motor is off.  
V = PFC control is by-passed and motor is connected direct on line.
- Cooling air fan for the alternation switchgear cabinet which includes the ACS 600 and the contactor logic (fan motor = M10)
- Indicator lamps (H1, H2)
- Operating hour counters (P1, P2)

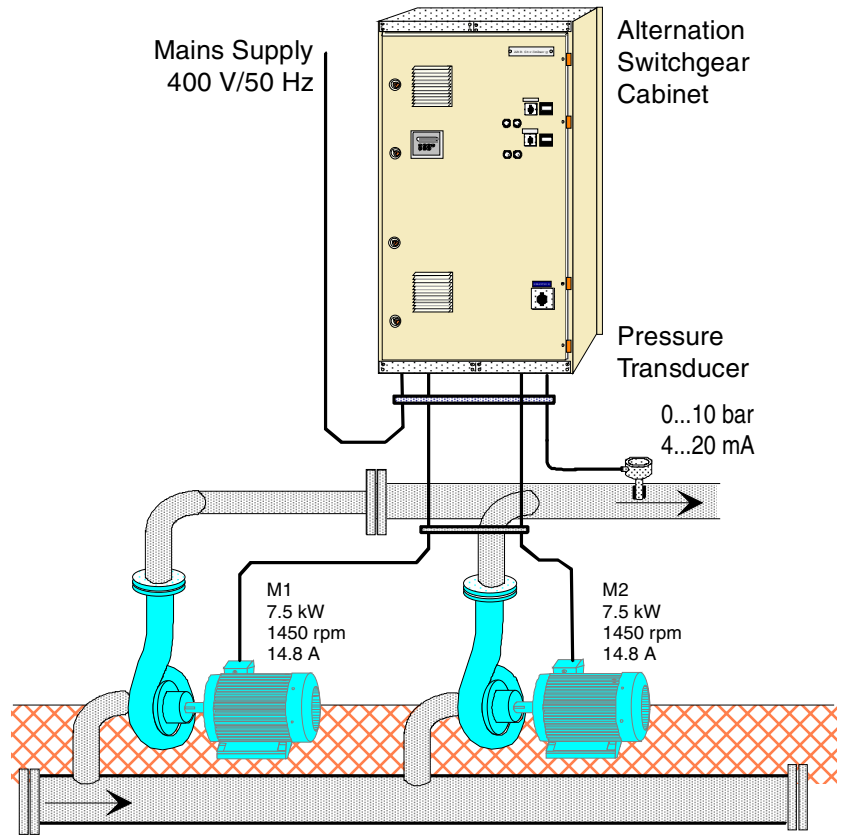
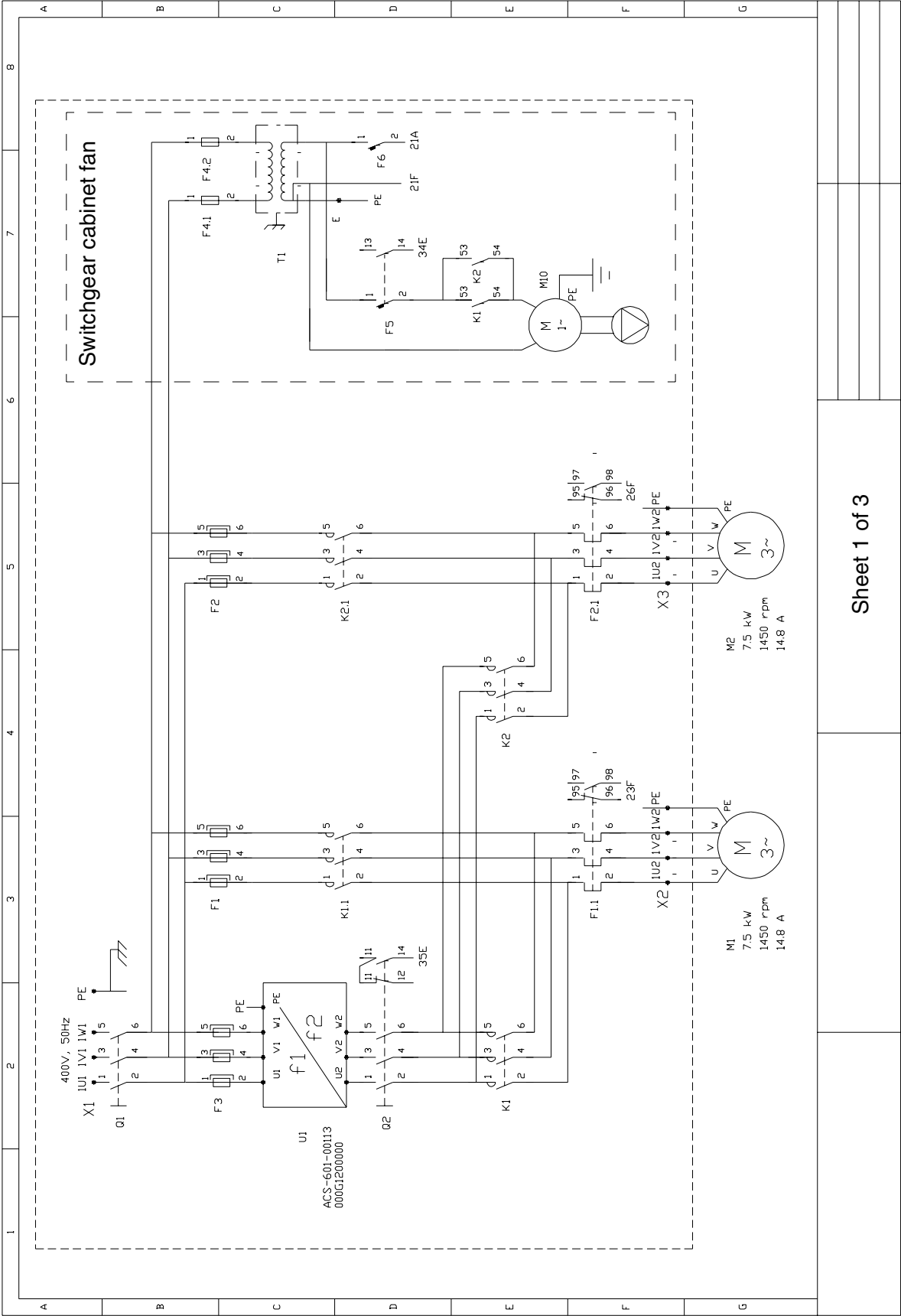
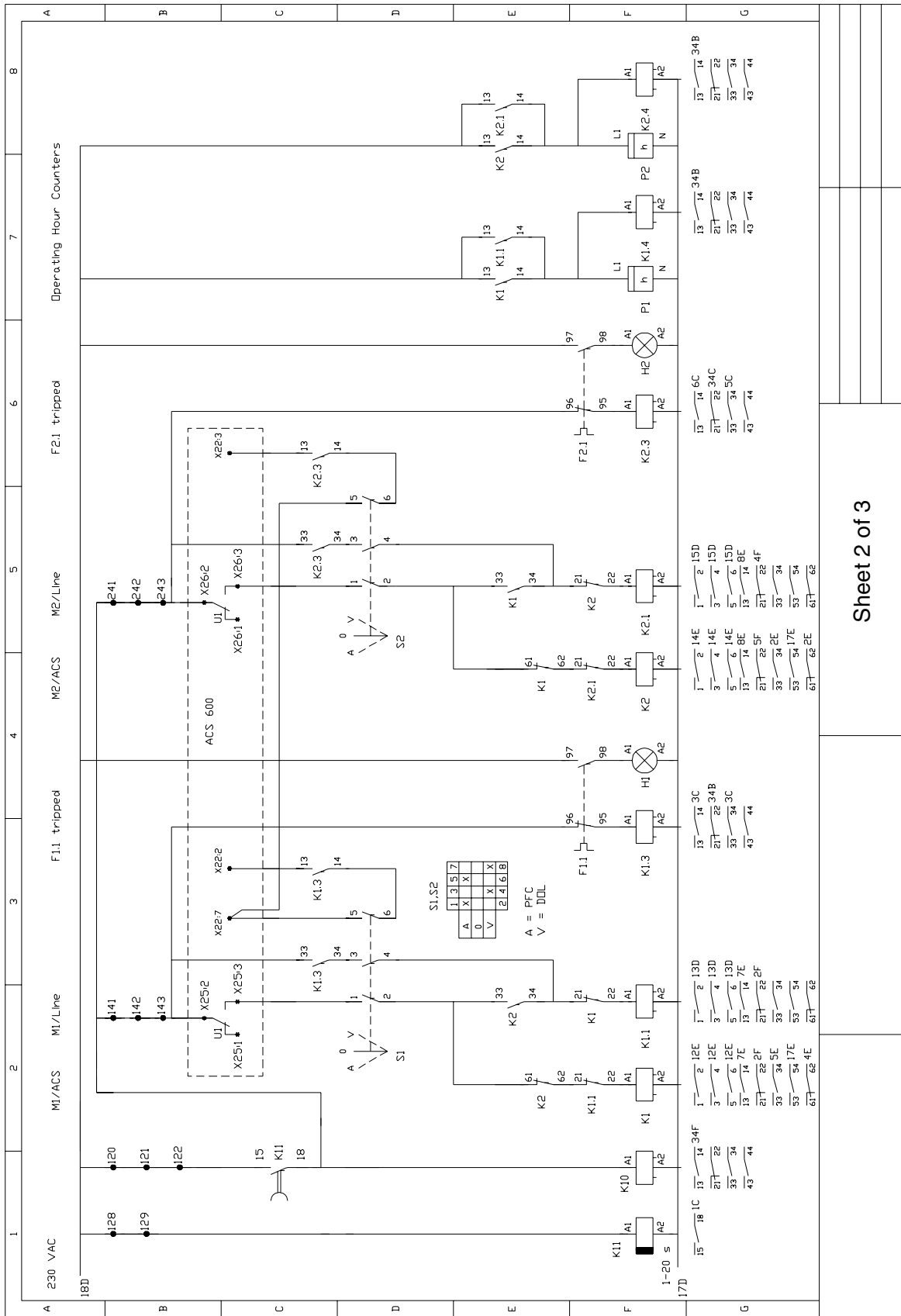

Figure B-1 Pumping station, general view. The ACS 600 is installed inside the alternation switchgear cabinet.





Sheet 2 of 3



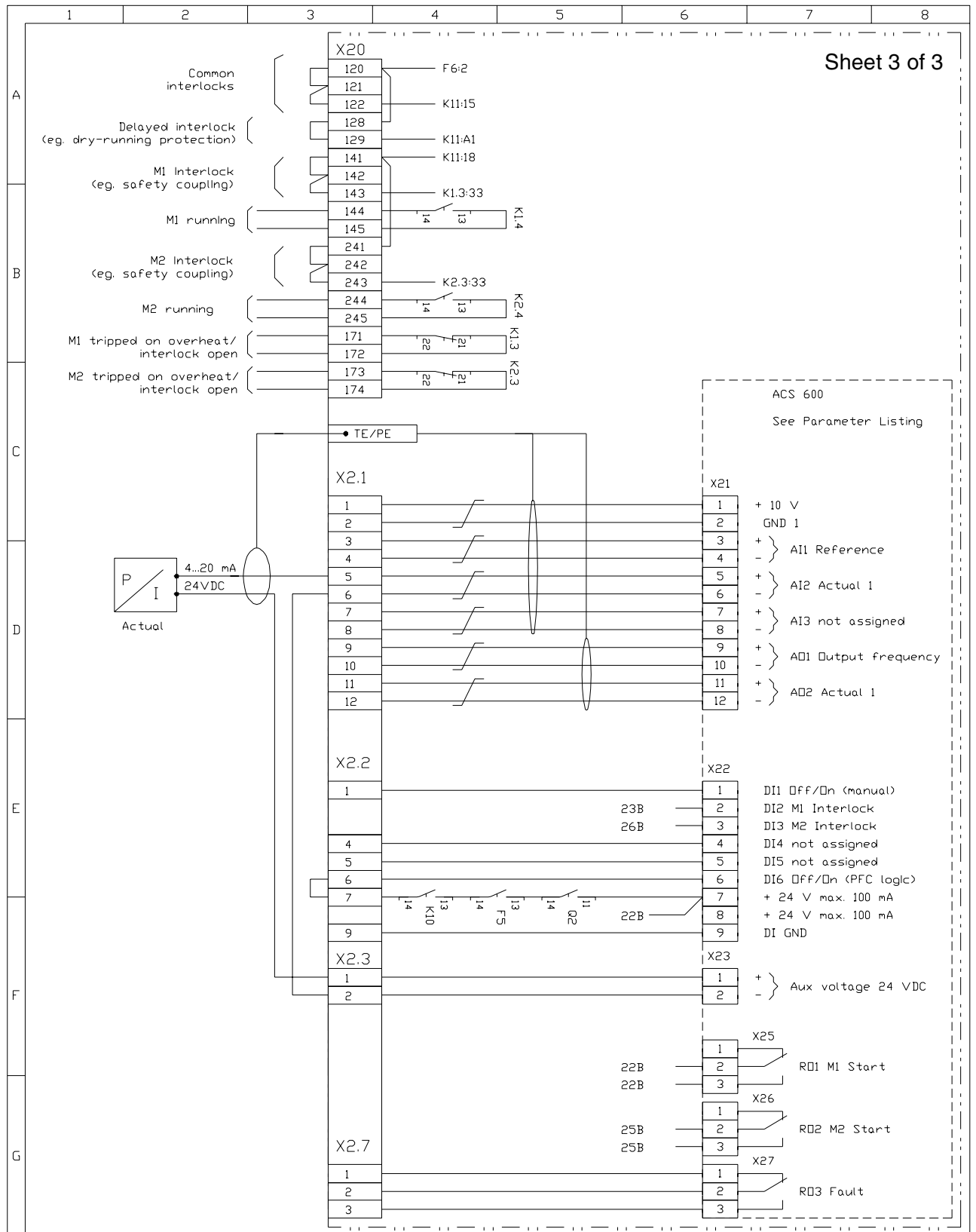



# Appendix C – Fieldbus Control

## Overview

The ACS 600 can be connected to an external control system – usually a fieldbus – via an adapter module (connected to fibre optic channel CH0 on the NDCO board) and/or a Modbus-protocol RS-485 connection (on the NIOC-01 board).

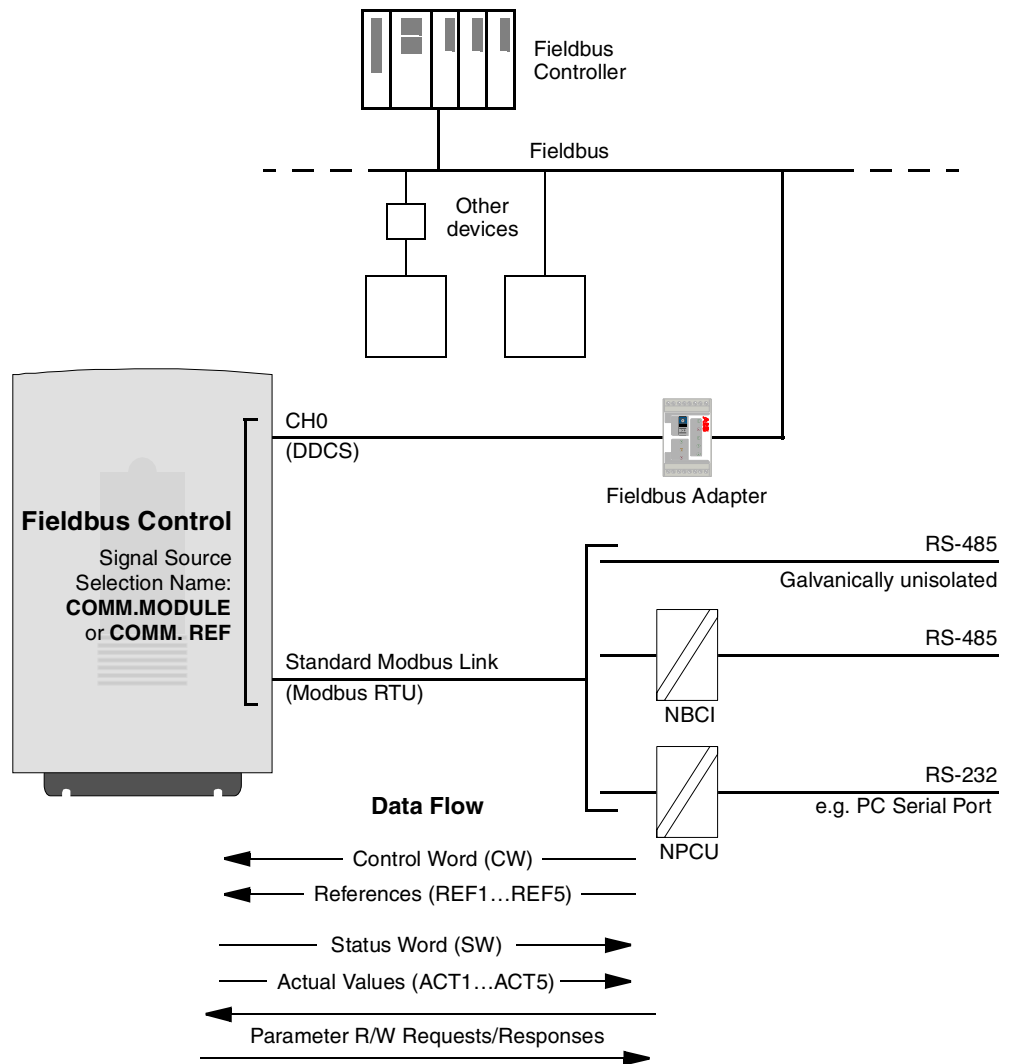

Figure C-1 Fieldbus control.

The drive can be set to receive all of its control information from one fieldbus channel, or the control can be distributed between the two fieldbus channels and other available sources, e.g. digital and analogue inputs.

**Control via NDCO Board Channel CH0**

The DDCS-protocol fibre optic channel CH0, located on the NDCO add-on communication board, is used for connecting the ACS 600 to a fieldbus adapter module. (The NDCO board may be ordered factory-installed or as an add-on kit. It is also installed at the factory if required by another option.)

Channel CH0 is also used for connecting the ACS 600 to an Advant control system. From the drive’s point of view, Advant connection is similar to a fieldbus adapter connection.

**Fieldbus Adapter Communication Set-up**

Before configuring the ACS 600 for fieldbus control, the adapter module must be mechanically and electrically installed according to the instructions given in the *Hardware Manual* of the drive and the module manual.

The communication between the ACS 600 and the fieldbus adapter module is then activated by setting Parameter [98.02 COMM. MODULE LINK](#). After the communication is initialised, the configuration parameters of the module become available in the drive at Parameter Group 51. These parameters are specific to the module used; see its manual for information on the available settings.

Table C-1 Communication set-up parameters for channel CH0 (for fieldbus adapter connection).

Parameter	Alternative Settings	Setting for Control through CH0	Function/Information
<i>COMMUNICATION INITIALISATION</i>			
<a href="#">98.02 COMM. MODULE LINK</a>	NO; FIELDBUS; ADVANT; STD MODBUS; CUSTOMISED	FIELDBUS	Initialises communication between drive (fibre optic channel CH0) and fieldbus adapter module. Activates module parameters (Group 51).
<a href="#">98.05 COMM INTERFACE</a>	ABB DRIVES; CSA 2.8/3.0	ABB DRIVES	Selects the communication profile used by the drive. Affects both fieldbus channels (fibre optic channel CH0 and Standard Modbus Link). See section <i>Communication Profiles</i> later in this Appendix.
<i>ADAPTER MODULE CONFIGURATION (Module-specific; see module manual.)</i>			
51.01 (FIELDBUS PARAMETER 1)		–	
...	...	...	...
51.15 (FIELDBUS PARAMETER 15)		–	

After the parameters in Group 51 have been set, the drive control parameters (shown in [Table C-4](#)) must be checked and adjusted where necessary.

**AF 100 Connection** The connection of an ACS 600 to an AF (Advant Fieldbus) 100 bus is similar to other fieldbusses, with the exception that one of the AF 100 interfaces listed below is substituted for the fieldbus adapter. As opposed to other fieldbusses, Parameter Group 51 contains no adjustable parameters. The drive (channel CH0) is connected to the AF 100 interface using fibre optic cables. The following is a list of suitable interfaces:

- **CI810 Fieldbus Communication Interface**  
*TB811 (5 MBd) or TB810 (10 MBd) Optical ModuleBus Port Interface required*
- **Advant Controller 70 (AC 70)**  
*TB811 (5 MBd) or TB810 (10 MBd) Optical ModuleBus Port Interface required*
- **Advant Controller 80 (AC 80)**  
*Optical ModuleBus connection: TB811 (5 MBd) or TB810 (10 MBd) Optical ModuleBus Port Interface required*  
*DriveBus connection: Connectible to NAMC-11 Board with NDCO-01 Communication Option.*

One of the above interfaces may already be present on the AF 100 bus. If not, an Advant Fieldbus 100 Adapter kit (NAFA-01) is separately available, containing the CI810 Fieldbus Communication Interface, a TB811 Optical ModuleBus Port Interface, and a TC505 Trunk Tap. (For more information on these components, see the *S800 I/O User's Guide*, 3BSE 008 878 [ABB Industrial Systems, Västerås, Sweden]).

#### *Optical Component Types*

The TB811 Optical ModuleBus Port Interface is equipped with 5 MBd optical components, while the TB810 has 10 MBd components. All optical components on a fibre optic link must be of the same type since 5 MBd components do not communicate with 10 MBd components. The choice between TB810 and TB811 depends on the equipment it is connected to.

The TB811 (5 MBd) should be used when connecting to a drive with the following equipment:

- NAMC-03 Board (not used with PFC Application Program version 5.2 or higher)
- NAMC-11/51 Board with NDCO-02 Communication Option
- NAMC-11/51 Board with NDCO-03 Communication Option
- NAMC-22 Board.

The TB810 (10 MBd) should be used when connecting to the following equipment:

- NAMC-11/51 Board with NDCO-01 Communication Option
- NAMC-21 Board
- NDBU-85/95 DDCS Branching Units.

**Communication Set-up** The communication between the ACS 600 and the AF 100 interface is activated by setting Parameter **98.02 COMM. MODULE LINK** to ADVANT.

Table C-2 Communication set-up parameters for channel CH0 (for AF 100 connection).

Parameter	Alternative Settings	Setting for Control through CH0	Function/Information
<i>COMMUNICATION INITIALISATION</i>			
<b>98.02 COMM. MODULE LINK</b>	NO; FIELDBUS; ADVANT; STD MODBUS, CUSTOMISED	ADVANT	Initialises communication between drive (fibre optic channel CH0) and AF 100 interface. The transmission speed is 4 Mbit/s.
<b>98.05 COMM INTERFACE</b>	ABB DRIVES; CSA 2.8/3.0	ABB DRIVES	Selects the communication profile used by the drive. Affects both fieldbus channels (fibre optic channel CH0 and Standard Modbus Link). See section <i>Communication Profiles</i> later in this Appendix.

After the communication activation parameters have been set, the AF 100 interface must be programmed according to its documentation, and the drive control parameters (shown in [Table C-4](#)) checked and adjusted where necessary.

**In an Optical ModuleBus connection**, the value for drive Parameter **70.01 CHANNEL 0 ADDR** is calculated from the value of the POSITION terminal in the appropriate database element (for the AC 80, DRISTD) as follows:

1. Multiply the hundreds of the value of POSITION by 16.
2. Add the tens and ones of the value of POSITION to the result.

For example, if the POSITION terminal of the DRISTD database element has the value of 110 (the tenth drive on the Optical ModuleBus ring), Parameter 70.01 must be set to  $16 \times 1 + 10 = 26$ .

**In an AC 80 DriveBus connection**, the drives are addressed 1 to 12. The drive address (set with Parameter 70.01) is related to the value of the DRNR terminal of the ACSRX PC element.

### Control through the Standard Modbus Link

The modular jacks (X28 and X29) on the ACS 600 NIOC-01 board form the Standard Modbus Link. The Link can be used for external control by a Modbus RTU-protocol controller. The controller can be connected either directly or using an NBCI-01 Panel Bus Connection Interface module to obtain galvanic isolation and parallel or long-distance connection of several drives.

An RS-232 port (e.g. a serial port of a PC) can be connected to the Standard Modbus Link through an NPCU-01 PC Connection Unit, which provides galvanic isolation and RS-232/RS-485 conversion. (However, the DriveWindow Light PC tool can only be connected to the Control Panel connector on the NAMC board.)

**Communication Set-up** The communication through the Standard Modbus Link is initialised by setting Parameter [98.02 COMM. MODULE LINK](#) to STD MODBUS. Then, the communication parameters in Group 52 must be adjusted. See the following table.

Table C-3 Communication set-up parameters for the Standard Modbus Link.

Parameter	Alternative Settings	Setting for Control through the Standard Modbus Link	Function/Information
<i>COMMUNICATION INITIALISATION</i>			
<a href="#">98.02 COMM. MODULE LINK</a>	NO; FIELDBUS; ADVANT; STD MODBUS; CUSTOMISED	STD MODBUS	Initialises communication between drive (Standard Modbus Link) and Modbus-protocol controller. Activates communication parameters in Group 52.
<a href="#">98.05 COMM INTERFACE</a>	ABB DRIVES; CSA 2.8/3.0	ABB DRIVES	Selects the communication profile used by the drive. Affects both fieldbus channels (fibre optic channel CH0 and Standard Modbus Link). See section <i>Communication Profiles</i> later in this Appendix.
<i>COMMUNICATION PARAMETERS</i>			
<a href="#">52.01 STATION NUMBER</a>	1 ... 247	–	Specifies the station number of the drive on the Standard Modbus link.
<a href="#">52.02 BAUDRATE</a>	600; 1200; 2400; 4800; 9600	–	Communication speed for the Standard Modbus Link.
<a href="#">52.03 PARITY</a>	ODD; EVEN; NONE1STOPBIT; NONE2STOPBIT	–	Parity setting for the Standard Modbus Link.

After the parameters in Group 52 have been set, the drive control parameters (shown in [Table C-4](#)) should be checked and adjusted where necessary.

**Drive Control Parameters**

After the desired fieldbus channels have been set up, the drive control parameters listed below in [Table C-4](#) below should be checked and adjusted where necessary.

The **Setting for Fieldbus Control** column gives the value to use when either fieldbus channel (CH0 or Standard Modbus Link) is the desired source or destination for that particular signal. The **Function/Information** column gives a description of the parameter.

The fieldbus signal routes and message composition are explained later in this Appendix under **The Fieldbus Control Interface**. Further information on the alternative parameter settings is also given in Chapter 6.

Table C-4 Drive control parameters to be checked and adjusted for fieldbus control.

Parameter	Alternative Settings	Setting for Fieldbus Control	Function/Information
<i>CONTROL COMMAND SOURCE SELECTION</i>			
10.01 EXT1 STRT/STP/DIR	NOT SEL; DI1; ...; COMM.MODULE	COMM.MODULE	Enables the fieldbus Control Word (except bit 11) when EXT1 is selected as control location.
10.02 EXT2 STRT/STP/DIR	NOT SEL; D1; ...; COMM.MODULE	COMM.MODULE	Enables the fieldbus Control Word (except bit 11) when EXT2 is selected as control location.
10.03 DIRECTION	FORWARD; REVERSE; REQUEST	REQUEST	Enables rotation direction control as defined by Parameters 10.01 and 10.02.
11.02 EXT1/EXT2 SELECT	DI1; ...; COMM.MODULE	COMM.MODULE	Enables EXT1/EXT2 selection by fieldbus Control Word bit 11 EXT CTRL LOC.
11.03 EXT REF1 SELECT	KEYPAD; ...; COMM.REF; COMMREF+AI1; COMMREF*AI1	COMM.REF, COMMREF+AI1 or COMMREF*AI1	Fieldbus reference REF1 is used when EXT1 is selected as control location. See section <i>References</i> below for information on the alternative settings.
11.06 EXT REF2 SELECT	KEYPAD; ...; COMM.REF; COMMREF+AI1; COMMREF*AI1	COMM.REF, COMMREF+AI1 or COMMREF*AI1	Fieldbus reference REF2 is used when EXT2 is selected as control location. See section <i>References</i> below for information on the alternative settings.
<i>OUTPUT SIGNAL SOURCE SELECTION</i>			
14.01 RELAY RO1 OUTPUT	READY; ...; COMM.MODULE	COMM.MODULE	Enables Relay output RO1 control by fieldbus reference REF3 bit 13.
14.02 RELAY RO2 OUTPUT	READY; ...; COMM.MODULE	COMM.MODULE	Enables Relay output RO2 control by fieldbus reference REF3 bit 14.
14.03 RELAY RO3 OUTPUT	READY; ...; COMM.MODULE	COMM.MODULE	Enables Relay output RO3 control by fieldbus reference REF3 bit 15.
15.01 ANALOGUE OUTPUT 1	NOT USED; P SPEED; ...; COMM.MODULE	COMM.MODULE	Directs the contents of fieldbus reference REF4 to Analogue output AO1. <b>Scaling:</b> 20000 = 20 mA
15.06 ANALOGUE OUTPUT 2	NOT USED; P SPEED; ...; COMM.MODULE	COMM.MODULE	Directs the contents of fieldbus reference REF5 to Analogue output AO2. <b>Scaling:</b> 20000 = 20 mA.



Parameter	Alternative Settings	Setting for Fieldbus Control	Function/Information
<i>SYSTEM CONTROL INPUTS</i>			
16.01 RUN ENABLE	YES; DI1; ...; COMM.MODULE	COMM.MODULE	Enables the control of the Run Enable signal through fieldbus Control Word bit 3.
16.04 FAULT RESET SEL	NOT SEL; DI1; ...; COMM.MODULE	COMM.MODULE	Enables fault reset through fieldbus Control Word bit 7.
16.07 PARAM SAVE	SAVE.; DONE		Saves parameter value changes (incl. those made through fieldbus control) to permanent memory. See <i>Chapter 6 – Parameters</i> .
<i>COMMUNICATION FAULT FUNCTIONS</i>			
30.19 COMM FAULT FUNC	NO; FAULT; CONST SP 15; LAST SPEED	–	Determines drive action in case fieldbus communication is lost. <b>Note:</b> The communication loss detection is based on monitoring of received Main and Auxiliary data sets (whose sources are selected with Parameters 90.04 and 90.05).
30.20 MAIN REF DS T-OUT	0.1 ... 60 s	–	Defines the time between Main Reference data set loss detection and the action selected with Parameter 30.18.
30.21 COMM FAULT RO/AO	ZERO; LAST VALUE	–	Determines the position in which Relay outputs RO1 to RO3 and Analogue outputs AO1 and AO2 are left upon Auxiliary Reference data set loss.
30.22 AUX REF DS T-OUT	0.1 ... 60 s	–	Defines the time between Auxiliary Reference data set loss detection and the action selected with Parameter 30.19. <b>Note:</b> This supervision function is disabled if Pars. 90.01, 90.02 and 90.03 are set to 0.
<i>FIELDBUS REFERENCE TARGET SELECTION</i> (Not visible when 98.02 is set to NO.)			
90.01 AUX DS REF3	0 ... 8999 <b>Default:</b> 0 (None selected)	–	Defines the drive parameter into which the value of fieldbus reference REF3 is written. <b>Format:</b> <b>xyy</b> , where <b>xx</b> = Parameter Group (10 to 89), <b>yy</b> = Parameter Index. E.g. <b>3001</b> = Parameter 30.01.
90.02 AUX DS REF4	0 ... 8999 <b>Default:</b> 0 (None selected)	–	Defines the drive parameter into which the value of fieldbus reference REF4 is written. <b>Format:</b> see Parameter 90.01.
90.03 AUX DS REF5	0 ... 8999 <b>Default:</b> 0 (None selected)	–	Defines the drive parameter into which the value of fieldbus reference REF5 is written. <b>Format:</b> see Parameter 90.01.
90.04 MAIN DS SOURCE	1; 81	–	If <b>98.02 COMM. MODULE LINK</b> = CUSTOMISED this parameter selects the fieldbus channel from which the drive reads the Main Reference data set (comprising the fieldbus Control Word, and fieldbus References REF1 and REF2).
90.05 AUX DS SOURCE	3; 83	–	If <b>98.02 COMM. MODULE LINK</b> = CUSTOMISED this parameter selects the fieldbus channel from which the drive reads the Auxiliary Reference data set (comprising fieldbus References REF3, REF4 and REF5).

Appendix C – Fieldbus Control

Parameter	Alternative Settings	Setting for Fieldbus Control	Function/Information
<i>ACTUAL SIGNAL SELECTION FOR FIELDBUS</i> (Not visible when 98.02 is set to NO.)			
92.01 MAIN DS STATUS WORD	<b>Fixed</b> to 302 (Actual Signal 3.02 MAIN STATUS WORD).	302 (Fixed)	The Status Word is transmitted to as the first word of the Main Actual Signal data set.
92.02 MAIN DS ACT1	0 ... 9999 <b>Default:</b> 102 (Actual Signal 1.02 FREQUENCY)	–	Selects the Actual signal or Parameter value to be transmitted as the second word (ACT1) of the Main Actual Signal data set. <b>Format:</b> (x)xyy, where (x)x = Actual Signal Group or Parameter Group, yy = Actual Signal or Parameter Index. E.g. <b>103</b> = Actual Signal 1.03 CURRENT; <b>2202</b> = Parameter <b>22.02 ACCEL TIME 1</b> .
92.03 MAIN DS ACT2	0 ... 9999 <b>Default:</b> 105 (Actual Signal 1.05 POWER)	–	Selects the Actual signal or Parameter value to be transmitted as the third word (ACT2) of the Main Actual Signal data set. <b>Format:</b> see Parameter 92.02.
92.04 AUX DS ACT3	0 ... 9999 <b>Default:</b> 305 (Actual Signal 3.05 FAULT WORD 1)	–	Selects the Actual signal or Parameter value to be transmitted as the first word (ACT3) of the Auxiliary Actual Signal data set. <b>Format:</b> see Parameter 92.02.
92.05 AUX DS ACT4	0 ... 9999 <b>Default:</b> 308 (Actual Signal 3.08 ALARM WORD 1)	–	Selects the Actual signal or Parameter value to be transmitted as the second word (ACT4) of the Auxiliary Actual Signal data set. <b>Format:</b> see Parameter 92.02.
92.06 AUX DS ACT5	0 ... 9999 <b>Default:</b> 306 (Actual Signal 3.06 FAULT WORD 2)	–	Selects the Actual signal or Parameter value to be transmitted as the third word (ACT5) of the Auxiliary Actual Signal data set. <b>Format:</b> see Parameter 92.02.

## **The Fieldbus Control Interface**

The communication between a fieldbus system and the ACS 600 employs *data sets*. One data set consists of three 16-bit words. The ACS 600 Standard Application Program supports the use of four data sets, two in each direction. The ACS 600 has a memory location for two control and two status data sets for each fieldbus channel (the fibre optic channel CH0 and the Standard Modbus Link), totalling 4 input and 4 output memory locations. Two out of the four input data sets are selected with Parameter [98.02 COMM. MODULE LINK](#), [90.04 MAIN DS SOURCE](#) and [90.05 AUX DS SOURCE](#). The selected data sets form the *Main Reference data set* and the *Auxiliary Reference data set* which are used to control the drive.

The status information transmitted by the drive is selected with Parameters 92.01 to 92.03 (the *Main Actual Signal data set*), and the 92.04 to 92.06 (the *Auxiliary Actual Signal data set*).

The update time for the Main Reference and Main Actual Signal data sets is 12 milliseconds; for the Auxiliary Reference and Auxiliary Actual Signals, it is 100 milliseconds.

Figures C-2 and C-3 demonstrate the routes of input and output signals for fieldbus control.

## **The Control Word and the Status Word**

The Control Word (CW) is the principal means for controlling the drive from a fieldbus system. It is effective when the current control location (EXT1 or EXT2, see Parameters 10.01 and 10.02) is set to COMM. MODULE.

The Control Word (detailed in [Table C-5](#)) is sent by the fieldbus controller to the drive. The drive switches between its states (shown in [Figure C-4](#)) according to the bit-coded instructions of the Control Word.

The Status Word (SW) is a word containing status information, sent by the drive to the fieldbus controller. The composition of the Status Word is explained in [Table C-6](#).

## **References**

References (REF) are 16-bit words comprising a sign bit and a 15-bit integer. A negative reference (indicating reversed direction of rotation) is formed by calculating the two's complement from the corresponding positive reference value if the value of Parameter [10.01 EXT1 STRT/STP/DIR](#) or [10.02 EXT2 STRT/STP/DIR](#) is COMM. MODULE.

## **Fieldbus Reference Selection**

Fieldbus reference (called COMMREF in signal selection contexts) is selected by setting a Reference selection parameter – [11.03 EXT REF1 SELECT](#) or [11.06 EXT REF2 SELECT](#) – to COMMREF

**Fieldbus Reference Scaling** Fieldbus references REF1 and REF2 are scaled as shown in the table below.

Ref. No.	Application Macro Used (Par. 99.02)	Reference Type	Range	Scaling	Notes
REF1	(any)	Frequency	-32765 ... 32765	-20000 = -[Par. 11.05] 0 = 0 20000 = [Par. 11.05]	Not limited by Pars. 11.04/11.05. (Final reference limited by 20.01/20.02.)
REF2	PFC	Controller Reference	-32765 ... 32765	-10000 = -[Par. 11.08] 0 = 0 10000 = [Par. 11.08]	
	HAND/AUTO	Frequency	-32765 ... 32765	-20000 = -[Par. 11.05] 0 = 0 20000 = [Par. 11.05]	Not limited by Pars. 11.07/11.08. (Final reference limited by 20.01/20.02.)

**Actual Values** Actual Values (ACT) are 16-bit words containing information on selected operations of the drive. The functions to be monitored are selected with the parameters in Group 92. The scaling of the integers sent to the master as Actual Values depends on the selected function; please refer to the **Scaling for Fieldbus** column in the tables of [Appendix A – Complete Parameter Settings](#).

The contents of Group 3 Actual Signals are presented in this Appendix from [Table C-5](#) onwards. (The Control and Status Words are also available as Actual Signals 3.01 and 3.02 respectively.)

**Modbus Addressing** In the Modbus controller memory, the Control Word, the Status Word, the references, and the actual values are mapped as follows:

Address	Contents	Address	Contents
40001	Control Word	40004	Status Word
40002	REF1	40005	ACT1
40003	REF2	40006	ACT2
40007	REF3	40010	ACT3
40008	REF4	40011	ACT4
40009	REF5	40012	ACT5

More information on Modbus communication is available from the separate publication *NMBA-01 Installation and Start-up Guide* (3AFY 58919772 [English]; available from ABB Industry Oy, Helsinki, Finland) and the Modicon website <http://www.modicon.com>.

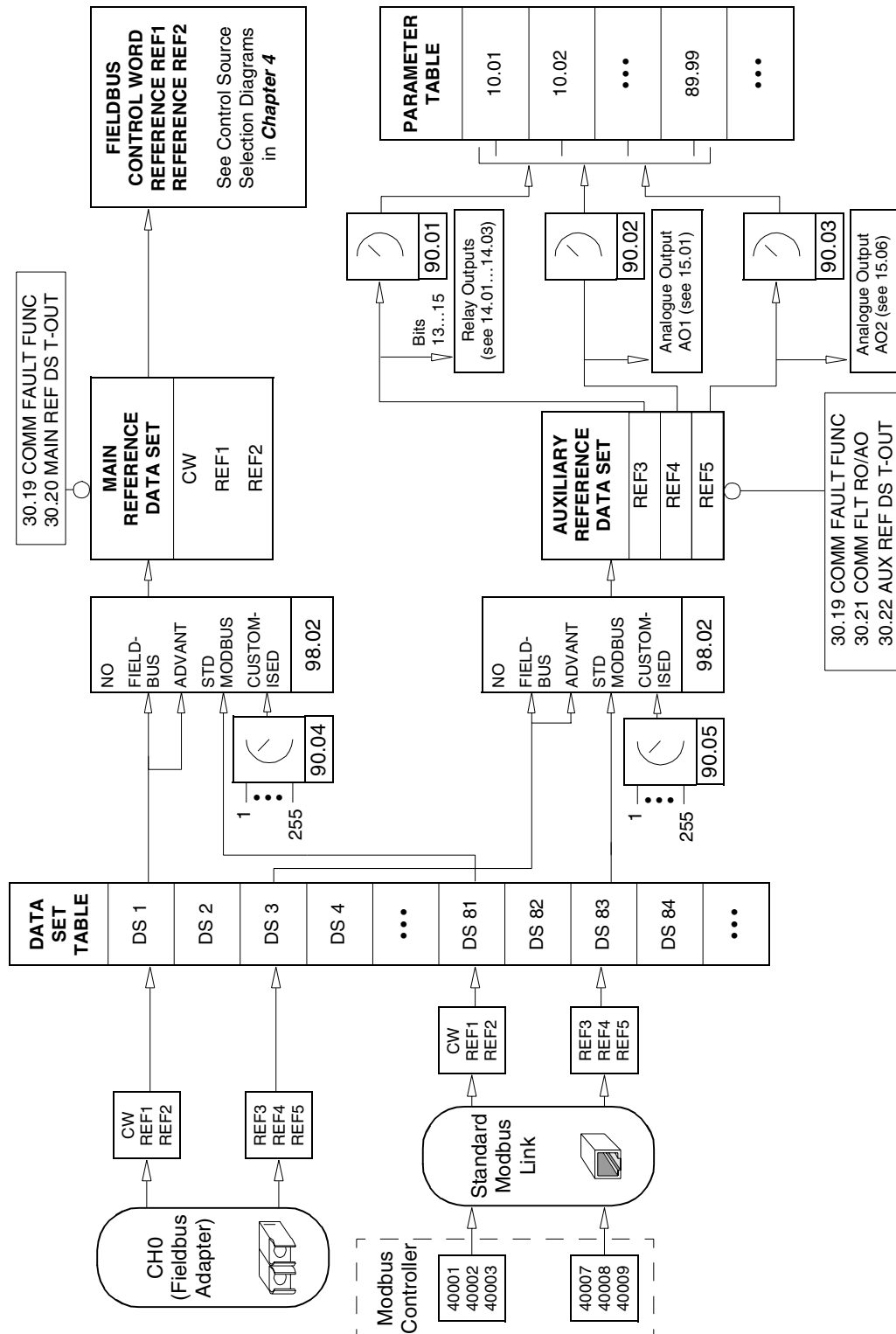
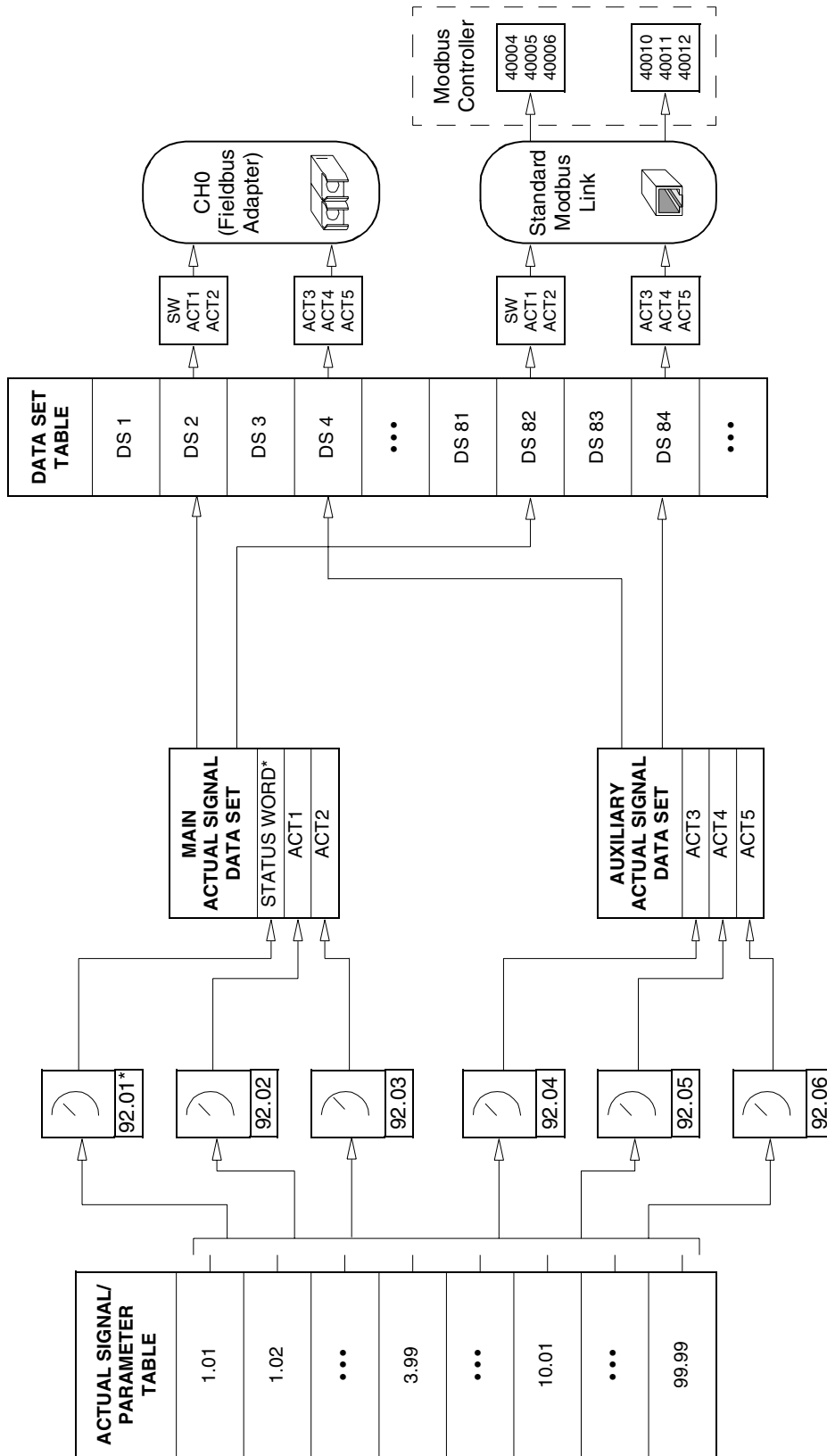

Figure C-2 Control data input from fieldbus.



\*Par. 92.01 is fixed to 3.02 MAIN STATUS WORD.

Figure C-3 Actual value selection for fieldbus.

## **Communication Profiles**

The PFC Application Program supports the *ABB Drives* communication profile, which standardises the control interface (such as the Control and Status Words) among ABB drives. The ABB Drives profile derives from the PROFIBUS control interface and provides a variety of control and diagnostic functions (see [Table C-5](#), [Table C-6](#), and [Figure C-4](#)).

In order to retain backward compatibility with PFC Application Program versions 2.8 and 3.0, a communication profile suitable for these versions (*CSA 2.8/3.0*) can be selected with Parameter [98.05 COMM INTERFACE](#). This eliminates the need for reprogramming the PLC when ACS 600 drives with older application program versions are replaced.

The Control Word and the Status Word for the *CSA 2.8/3.0* communication profile are detailed in [Table C-14](#) and [Table C-15](#) respectively.

---

**Note:** The communication profile selector parameter [98.05 COMM INTERFACE](#) affects both the optical CH0 and the Standard Modbus channels.

---

Table C-5 The Control Word (Actual Signal 3.01 MAIN CTRL WORD) for the ABB Drives Communication Profile. The upper case boldface text refers to the states shown in Figure C-4.

Bit	Name	Value	Proceed to STATE/Description
0	ON	1	Proceed to <b>READY TO OPERATE</b> .
	OFF1	0	Emergency OFF, stop within time defined by Par. 22.07 EM STOP RAMP TIME. Proceed to <b>OFF1 ACTIVE</b> ; proceed further to <b>READY TO SWITCH ON</b> unless other interlocks (OFF2, OFF3) are active.
1	OFF2	1	Continue operation (OFF2 inactive).
		0	Emergency OFF, coast to stop. Proceed to <b>OFF2 ACTIVE</b> ; proceed further to <b>SWITCH-ON INHIBITED</b> .
2	OFF3	1	Continue operation (OFF3 inactive).
		0	Emergency stop, stop within time defined by Par. 22.07 EM STOP RAMP TIME. Proceed to <b>OFF3 ACTIVE</b> ; proceed further to <b>SWITCH-ON INHIBITED</b> . <b>Warning:</b> Ensure motor and driven machine can be stopped using this stop mode.
3	START	1	Proceed to <b>OPERATION ENABLED</b> . ( <i>Note:</i> The Run enable signal must be active; see Parameter 16.01. If Par. 16.01 is set to COMM. MODULE, this bit also activates the Run enable signal.)
		0	Inhibit operation. Proceed to <b>OPERATION INHIBITED</b> .
4	RAMP_OUT_ZERO	1	Normal operation. Proceed to <b>RAMP FUNCTION GENERATOR: OUTPUT ENABLED</b> .
		0	Force Ramp Function Generator output to zero. Drive ramps to stop (current and DC voltage limits in force).
5	RAMP_HOLD	1	Enable ramp function. Proceed to <b>RAMP FUNCTION GENERATOR: ACCELERATOR ENABLED</b> .
		0	Halt ramping (Ramp Function Generator output held).
6	RAMP_IN_ZERO	1	Normal operation. Proceed to <b>OPERATING</b> .
		0	Force Ramp Function Generator input to zero.
7	RESET	0 ⇒ 1	Fault reset if an active fault exists. Proceed to <b>SWITCH-ON INHIBITED</b> .
		0	Continue normal operation.
8	INCHING_1	1	Not in use.
		1 ⇒ 0	Not in use.
9	INCHING_2	1	Not in use.
		1 ⇒ 0	Not in use.
10	REMOTE_CMD	1	Fieldbus control enabled.
		0	Control Word <> 0 or Reference <> 0: Retain last Control Word and Reference. Control Word = 0 and Reference = 0: Fieldbus control enabled. Reference and deceleration/acceleration ramp are locked.
11	EXT CTRL LOC	1	Select External Control Location 2 (EXT2). Effective if Par. 11.02 is set to COMM.MODULE.
		0	Select External Control Location 1 (EXT1). Effective if Par. 11.02 is set to COMM.MODULE.
12 to 15	Reserved		



**Table C-6** The Status Word (Actual Signal 3.02 MAIN STATUS WORD) for the ABB Drives Communication Profile. The upper case boldface text refers to the states shown in [Figure C-4](#).

Bit	Name	Value	STATE/Description
0	RDY_ON	1	<b>READY TO SWITCH ON.</b>
		0	<b>NOT READY TO SWITCH ON.</b>
1	RDY_RUN	1	<b>READY TO OPERATE.</b>
		0	<b>OFF1 ACTIVE.</b>
2	RDY_REF	1	<b>OPERATION ENABLED.</b>
		0	<b>OPERATION INHIBITED.</b>
3	TRIPPED	1	<b>FAULT.</b>
		0	No fault.
4	OFF_2_STA	1	OFF2 inactive.
		0	<b>OFF2 ACTIVE.</b>
5	OFF_3_STA	1	OFF3 inactive.
		0	<b>OFF3 ACTIVE.</b>
6	SWC_ON_INHIB	1	<b>SWITCH-ON INHIBITED.</b>
		0	
7	ALARM	1	Warning/Alarm.
		0	No Warning/Alarm.
8	AT_SETPOINT	1	<b>OPERATING.</b> Actual value equals reference value (= is within tolerance limits).
		0	Actual value differs from reference value (= is outside tolerance limits).
9	REMOTE	1	Drive control location: REMOTE (EXT1 or EXT2).
		0	Drive control location: LOCAL.
10	ABOVE_LIMIT	1	Actual frequency or speed value equals or is greater than supervision limit (Par. 32.03). Valid in both rotation directions regardless of value of Par. 32.03.
		0	Actual frequency or speed value is within supervision limit.
11	EXT CTRL LOC	1	External Control Location 2 (EXT2) selected.
		0	External Control Location 1 (EXT1) selected.
12	EXT RUN ENABLE	1	External Run Enable signal received.
		0	No External Run Enable received.
13 to 14	Reserved		
15		1	Communication error detected by fieldbus adapter module (on fibre optic channel CH0).
		0	Fieldbus adapter (CH0) communication OK.

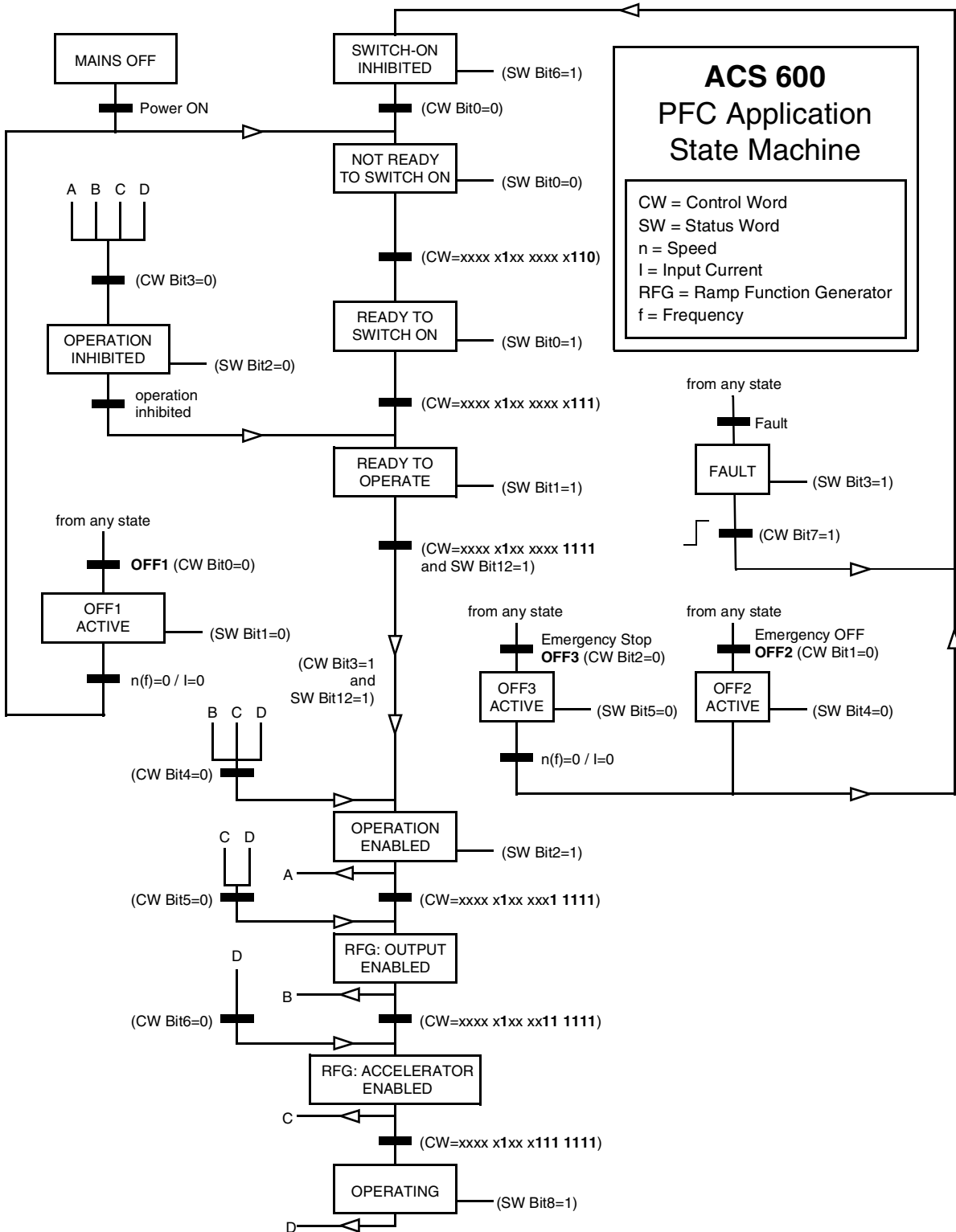

Figure C-4 The ACS 600 State Machine for the PFC Application Program (ABB Drives Communication Profile), effective under fieldbus control.

Table C-7 The Auxiliary Status Word (Actual Signal 3.03 AUX STATUS WORD).

Bit	Name	Description
0	Reserved	
1	OUT OF WINDOW	Speed difference is out of the window (in speed control)*.
2	Reserved	
3	MAGNETIZED	Flux has been formed in the motor.
4	Reserved	
5	SYNC RDY	Position counter synchronised.
6	1 START NOT DONE	Drive has not been started after changing the motor parameters in Group 99.
7	IDENTIF RUN DONE	Motor ID Run successfully completed.
8	START INHIBITION	Prevention of unexpected start-up active.
9	LIMITING	Control at a limit. See Actual signal 3.04 LIMIT WORD 1 below.
10	TORQ CONTROL	Torque reference is followed*.
11	ZERO SPEED	Absolute value of motor actual speed is below zero speed limit (4% of synchronous speed).
12	INTERNAL SPEED FB	Internal speed feedback followed.
13	M/F COMM ERR	Master/Follower link (on CH2) communication error*.
14	Reserved	
15	Reserved	

\*See Application Guide: Master/Follower Application Macro (3AFY 58962180 [English]).

Table C-8 Limit Word 1 (Actual Signal 3.04 LIMIT WORD 1).

Bit	Name	Active Limit
0	TORQ MOTOR LIM	Pull-out limit.
1	SPD_TOR_MIN_LIM	Speed control torque min. limit.
2	SPD_TOR_MAX_LIM	Speed control torque max. limit.
3	TORQ_USER_CUR_LIM	User-defined current limit.
4	TORQ_INV_CUR_LIM	Internal current limit.
5	TORQ_MIN_LIM	Any torque min. limit.
6	TORQ_MAX_LIM	Any torque max. limit.
7	TREF_TORQ_MIN_LIM	Torque reference min. limit.
8	TREF_TORQ_MAX_LIM	Torque reference max. limit.
9	FLUX_MIN_LIM	Flux reference min. limit.
10	FREQ_MIN_LIMIT	Speed/Frequency min. limit.
11	FREQ_MAX_LIMIT	Speed/Frequency max. limit.
12	DC_UNDERVOLT	DC undervoltage limit.
13	DC_OVERVOLT	DC overvoltage limit.
14	TORQUE LIMIT	Any torque limit.
15	FREQ_LIMIT	Any speed/frequency limit.

Table C-9 Fault Word 1 (Actual Signal 3.05 FAULT WORD 1).

Bit	Name	Description
0	SHORT CIRC	For the possible causes and remedies, see Chapter 7 – Fault Tracing.
1	OVERCURRENT	
2	DC OVERVOLT	
3	ACx 600 TEMP	
4	EARTH FAULT	
5	THERMISTOR	
6	MOTOR TEMP	
7	SYSTEM_FAULT	A fault is indicated by the System Fault Word (Actual Signal 3.07).
8	UNDERLOAD	For the possible causes and remedies, see Chapter 7 – Fault Tracing.
9	OVERFREQ	
10	Reserved	
11	Reserved	
12	Reserved	
13	Reserved	
14	Reserved	
15	Reserved	

Table C-10 Fault Word 2 (Actual Signal 3.06 FAULT WORD 2).

Bit	Name	Description
0	SUPPLY PHASE	For the possible causes and remedies, see Chapter 7 – Fault Tracing.
1	NO MOT DATA	
2	DC UNDERVOLT	
3	Reserved	
4	RUN DISABLED	For the possible causes and remedies, see Chapter 7 – Fault Tracing.
5	ENCODER FLT	
6	I/O COMM	
7	AMBIENT TEMP	
8	EXTERNAL FLT	
9	OVER SWFREQ	Switching overfrequency fault.
10	AI < MIN FUNC	For the possible causes and remedies, see Chapter 7 – Fault Tracing.
11	PPCC LINK	
12	COMM MODULE	
13	PANEL LOSS	
14	MOTOR STALL	
15	MOTOR PHASE	

Table C-11 The System Fault Word (Actual Signal 3.07 SYSTEM FAULT).

Bit	Name	Description
0	FLT (F1_7)	Factory default parameter file error.
1	USER MACRO	User Macro file error.
2	FLT (F1_4)	FEPROM operating error.
3	FLT (F1_5)	FEPROM data error.
4	FLT (F2_12)	Internal time level 2 overflow.
5	FLT (F2_13)	Internal time level 3 overflow.
6	FLT (F2_14)	Internal time level 4 overflow.
7	FLT (F2_15)	Internal time level 5 overflow.
8	FLT (F2_16)	State machine overflow.
9	FLT (F2_17)	Application program execution error.
10	FLT (F2_18)	Application program execution error.
11	FLT (F2_19)	Illegal instruction.
12	FLT (F2_3)	Register stack overflow.
13	FLT (F2_1)	System stack overflow.
14	FLT (F2_0)	System stack underflow.
15	Reserved	

Table C-12 Alarm Word 1 (Actual Signal 3.08 ALARM WORD 1).

Bit	Name	Description
0	START INHIBIT	For the possible causes and remedies, see <i>Chapter 7 – Fault Tracing</i> .
1	Reserved	
2	Reserved	
3	MOTOR TEMP	For the possible causes and remedies, see <i>Chapter 7 – Fault Tracing</i> .
4	ACx 600 TEMP	
5	ENCODER ERR	
6	Reserved	
7	Reserved	
8	Reserved	
9	Reserved	
10	Reserved	
11	Reserved	
12	COMM MODULE	For the possible causes and remedies, see <i>Chapter 7 – Fault Tracing</i> .
13	THERMISTOR	
14	EARTH FAULT	
15	Reserved	

Table C-13 Alarm Word 2 (Actual Signal 3.09 ALARM WORD 2).

Bit	Name	Description
0	Reserved	
1	UNDERLOAD	For the possible causes and remedies, see Chapter 7 – Fault Tracing.
2	Reserved	
3	DC UNDERVOLT	For the possible causes and remedies, see Chapter 7 – Fault Tracing.
4	DC OVERVOLT	
5	OVERCURRENT	
6	OVERFREQ	
7	ALM (A_16)	Error in restoring POWERFAIL.DDF.
8	ALM (A_17)	Error in restoring POWERDOWN.DDF.
9	MOTOR STALL	For the possible causes and remedies, see Chapter 7 – Fault Tracing.
10	AI < MIN FUNC	
11	Reserved	
12	Reserved	
13	PANEL LOSS	For the possible causes and remedies, see Chapter 7 – Fault Tracing.
14	Reserved	
15	Reserved	

Table C-14 Control Word for the CSA 2.8/3.0 Communication Profile.

Bit	Name	Description
0	Reserved	
1	ENABLE	1 = Enabled 0 = Coast to stop
2	Reserved	
3	START/STOP	0→1 = Start 0 = Stop according to Parameter 21.03 STOP FUNCTION.
4	Reserved	
5	CNTRL_MODE	1 = Select control mode 2 0 = Select control mode 1
6	Reserved	
7	Reserved	
8	RESET_FAULT	0→1 = Reset drive fault
9...15	Reserved	

Table C-15 Status Word for the CSA 2.8/3.0 Communication Profile.

Bit	Name	Description
0	READY	1 = Ready to start 0 = Initialising, or initialisation error
1	ENABLE	1 = Enabled 0 = Coast to stop
2	Reserved	
3	RUNNING	1 = Running with selected reference 0 = Stopped
4	Reserved	
5	REMOTE	1 = Drive in Remote Mode 0 = Drive in Local Mode
6	Reserved	
7	AT_SETPOINT	1 = Drive at reference 0 = Drive not at reference
8	FAULTED	1 = A fault is active 0 = No active faults
9	WARNING	1 = A warning is active 0 = No active warnings
10	LIMIT	1 = Drive at a limit 0 = Drive at no limit
11...15	Reserved	





# Index

<b>A</b>			
ACC/DEC 1/2 SEL	6-29	AUX MOT STOP DLY	6-67
ACC/DEC RAMP SHPE	6-30	AUX REF DS T-OUT	6-48
ACCEL TIME 1	6-29	<b>B</b>	
ACCEL TIME 2	6-30	BREAK POINT	6-44
Acceleration	6-29	<b>C</b>	
ACT1 FUNCTION	6-52	COMM FAULT FUNC	6-47
ACT1 LIMIT	6-52	COMM FAULT RO/AO	6-47
ACT1 MAXIMUM	6-60	COMM INTERFACE	6-84
ACT1 MINIMUM	6-59	COMM. MODULE LINK	6-83
ACT1 UNIT SCALE	6-60	CONST FREQ 1	6-9
ACT2 FUNCTION	6-53	CONST FREQ 2	6-9
ACT2 LIMIT	6-53	CONST FREQ 3	6-9
ACT2 MAXIMUM	6-60	CONST FREQ SEL	6-9
ACT2 MINIMUM	6-60	CONST MAGN TIME	6-28
ACT2 UNIT SCALE	6-60	CONST SET POINT	6-63
ACTUAL 1 INPUT SEL	6-59	Constant DC magnetising	6-27
ACTUAL 1 UNIT	6-60	Constant frequencies	6-9
ACTUAL 2 INPUT SEL	6-59	Constant speeds	
ACTUAL 2 UNIT	6-61	Not considered	4-5
ACTUAL FUNC SCALE	6-61	Control location	
Actual Signal Display Mode	2-4	selecting	4-5
Actual Signals	4-1	Control Locations	6-5
ACTUAL VALUE SEL	6-59	changing	2-13
AI	6-40	Control operation	C-1
AI HIGH LEVEL	6-79	Control Panel	2-1
AI LOW LEVEL	6-78	actual signal selection	2-5
AI MEASURE INLET	6-78	display	2-2
AI MEASURE OUTLET	6-79	setting the contrast	2-10
AI SIGNAL	6-50	keys	2-2
AI/O EXT MODULE	6-83	modes	2-3
Analogue inputs	6-10	Control source	
ANALOGUE OUTPUT1	6-19	selecting	4-5
ANALOGUE OUTPUT2	6-21	Critical frequencies	6-35
Analogue outputs	6-19	CURRENT	4-1
APPL PROFILE CTRL	6-80	CURRENT FUNCTION	6-52
APPL SW VERSION	6-54	CURRENT LIMIT	6-52
APPLIC RESTORE	3-8	<b>D</b>	
APPLICATION MACRO	3-8	DC magnetising	6-27
Application Macros	2-1, 5-1	DDCS communication	6-47
Autochange function	6-68	DECEL TIME 1	6-29
AUTOCHANGE INTERVAL	6-68	DECEL TIME 2	6-30
AUTOCHANGE LEVEL	6-69		
Automatic start	6-27		
AUX MOT START DLY	6-67		

Deceleration	6-29	FREQ 1 LIMIT	6-52
DELAY TIME	6-49	FREQ 2 FUNCTION	6-52
DI STATUS INLET	6-78	FREQ 2 LIMIT	6-52
DI STATUS OUTLET	6-79	FREQUENCY	4-1
DI/O EXT MODULE 2	6-83	Function Mode	2-9
DI/O PFC EXT	6-82		
DIRECTION	6-4	<b>G</b>	
Drive Selection Mode	2-12	GAIN	6-34
DTC (Direct Torque Control) Mode	3-9	Group 1 ACTUAL SIGNALS	4-1
<b>E</b>		Group 10 START/STOP/DIR	6-2
EARTH FAULT	6-46	Group 11 REFERENCE SELECT	6-5
EM STOP RAMP TIME	6-31	Group 12 CONSTANT FREQ	6-9
Emergency stop	6-31	Group 13 ANALOGUE INPUTS	6-10
ERROR VALUE INV	6-58	Group 14 RELAY OUTPUTS	6-14
EXT 2 REL OUTPUT 1	6-18	Group 15 ANALOGUE OUTPUTS	6-19
EXT 2 REL OUTPUT 2	6-18	Group 16 SYSTEM CTR INPUTS	6-22
EXT REF1 MAXIMUM	6-7	Group 2 ACTUAL SIGNALS	4-3
EXT REF1 MINIMUM	6-6	Group 20 LIMITS	6-25
EXT REF1 SELECT	6-6	Group 21 START/STOP	6-27
EXT REF2 MAXIMUM	6-7	Group 22 ACCEL/DECEL	6-29
EXT REF2 MINIMUM	6-7	Group 23 SPEED CTRL	6-32
EXT REF2 SELECT	6-7	Group 25 CRITICAL FREQ	6-35
EXT1 STRT/STP/DIR	6-2	Group 26 MOTOR CONTROL	6-37
EXT1/EXT2 SELECT	6-5	Group 3 ACTUAL SIGNALS	4-3
EXT2 STRT/STP/DIR	6-4	Group 30 FAULT FUNCTIONS	6-39
External control	4-5	Group 31 AUTOMATIC RESET	6-49
EXTERNAL FAULT	6-41	Group 32 SUPERVISION	6-51
<b>F</b>		Group 33 INFORMATION	6-54
Fault and warning messages	7-3	Group 51 COMM MOD DATA	6-55
Fault functions	6-39	Group 52 STANDARD MODBUS	6-55
Fault history	2-4, 4-4, 7-2	Group 70 DDCS CONTROL	6-56
displaying and resetting	2-7	Group 80 PI CONTROL	6-57
FAULT RESET SEL	6-23	Group 81 PFC CONTROL	6-62
Faults	7-1	Group 82 PRESSURE CONTROL	6-77
resetting	6-49, 7-1	Group 90 D SET REC ADDR	6-81
tracing	7-1	Group 92 D SET TR ADDR	6-81
Fieldbus control	6-83	Group 98 OPTION MODULES	6-82
FILTER AI1	6-11	Group 99 START-UP DATA	3-7
FILTER AI2	6-13	<b>H</b>	
FILTER AI3	6-13	Hand/Auto Application Macro	5-6
FILTER AO1	6-21	HEX FIELD WEAKEN	6-38
FILTER AO2	6-21	<b>I</b>	
FLUX BRAKING	6-37	ID Numbers	2-12
FLUX OPTIMIZATION	6-37	ID Run	3-4, 3-10
Flying start feature	6-28	Identification Display	2-4
FREQ 1 FUNCTION	6-52	INPUT CTRL DLY	6-78

INPUT PROT CTRL	6-78	MOTOR NOM SPEED	3-10
Integer scaling	C-1	MOTOR NOM VOLTAGE	3-9
INTEGRATION TIME	6-34	MOTOR PHASE LOSS	6-46
INTERLOCKS	6-70	MOTOR THERM PROT	6-41
Interlocks	3-1, 6-70	MOTOR THERM TIME	6-43
INVERT AI1	6-12	Motor thermal protection	6-41
INVERT AI2	6-13	Motors	
INVERT AI3	6-13	parallel connection	3-7
INVERT AO1	6-20	Multimotor drives	3-9
INVERT AO2	6-21		
IR COMPENSATION	6-38		
		<b>N</b>	
		NBR OF AUX MOTORS	6-68
<b>K</b>		NUMBER OF TRIALS	6-49
KEYPAD REF SEL	6-5		
		<b>O</b>	
		Operational commands	2-13
<b>L</b>		Option modules	6-82
LANGUAGE	3-8	OUTPUT CTRL DLY	6-79
Limits	6-25	OUTPUT PROT CTRL	6-79
Local Control	2-13	OVERCURRENT	6-49
LOCAL LOCK	6-24	OVERVOLTAGE	6-49
LOW FREQ 1	6-66	OVERVOLTAGE CTRL	6-26
LOW FREQ 2	6-66		
LOW FREQ 3	6-67	<b>P</b>	
LOW FREQ 4	6-76	P GENERATING LIM	6-26
		P MOTORING LIM	6-26
<b>M</b>		Panel Link	2-12
MAIN REF DS T-OUT	6-47	PANEL LOSS	6-41
MAXIMUM AI1	6-11	Panel Operation	2-4
MAXIMUM AI2	6-13	PARAM SAVE	6-24
MAXIMUM AI3	6-13	Parameter Groups	2-1, 6-1
MAXIMUM CURRENT	6-25	PARAMETER LOCK	6-23
MAXIMUM FREQUENCY	6-25	Parameter Mode	2-8
MAXIMUM TORQUE	6-25	Parameters	
MINIMUM AI1	6-11	copying from one unit to other units	2-11
MINIMUM AI2	6-12	restoring	3-8
MINIMUM AI3	6-13	selecting and changing	2-8
MINIMUM AO1	6-21	PASS CODE	6-23
MINIMUM AO2	6-21	PFC START DELAY	6-75
MINIMUM FREQUENCY	6-25	PI controller	6-57
MOT THERM P MODE	6-41	PI GAIN	6-58
Motor control	6-37	PI INTEG TIME	6-58
Motor control modes	3-9	PI REF DEC TIME	6-79
MOTOR CTRL MODE	3-9	PRESET FREQ	6-46
MOTOR ID RUN	3-10	Pressure supervision	6-77
MOTOR LOAD CURVE	6-44	PROF LIMIT ON DLY	6-80
MOTOR NOM CURRENT	3-9	PROFILE OUTP LIM	6-80
MOTOR NOM FREQUENCY	3-9	Pump and Fan Control (PFC) Macro	5-2
MOTOR NOM POWER	3-10		

## R

Ramps, Acceleration/Deceleration	6-29
REF1 FUNCTION	6-52
REF1 LIMIT	6-52
REF2 FUNCTION	6-52
REF2 LIMIT	6-52
Reference	
range	6-8
scaling	6-8
selecting	6-5
setting from Control Panel	2-14
REFERENCE STEP 1	6-63
REFERENCE STEP 2	6-63
REFERENCE STEP 3	6-63
REFERENCE STEP 4	6-75
REGUL BYPASS CTRL	6-73
Related publications	1-2
Relay outputs	6-14
RELAY RO1 OUTPUT	6-14
RELAY RO2 OUTPUT	6-17
RELAY RO3 OUTPUT	6-17
Remote Control	2-13
RUN ENABLE	6-22
Run Enable signal	6-22

## S

Safety Instructions	i
Safety instructions	i
Scalar control mode	3-9
SCALAR FLYSTART	6-28
SCALE AI1	6-11
SCALE AI2	6-13
SCALE AI3	6-13
SCALE AO1	6-21
SCALE AO2	6-21
SET POINT	6-63
SLEEP DELAY	6-64
Sleep function	6-64, 6-76
SLEEP LEVEL	6-64
SLEEP SELECTION	6-76
SLIP GAIN	6-34
SOFTWARE VERSION	6-54
SPEED	4-1
Speed controller	6-32
SPEED EST	4-3
SPEED REF 2	4-3
SPEED REF 3	4-3
STALL FREQ HI	6-45

STALL FUNCTION	6-44
STALL TIME	6-45
Standard Modbus Link	6-55
START FREQ 1	6-65
START FREQ 2	6-65
START FREQ 3	6-66
START FREQ 4	6-75
START FUNCTION	6-27
Start, Stop, Direction and Reference	2-13
Start-up procedure	3-1
STOP FUNCTION	6-28
Supervision	6-51
System control inputs	6-22

## T

TEST DATE	6-54
Thermal protection of motor	6-41
TORQ REF 2	4-3
TORQ REF 3	4-3
TORQ REF USED	4-3
TORQUE	4-1
TRIAL TIME	6-49

## U

UNDERLOAD CURVE	6-46
UNDERLOAD FUNC	6-45
UNDERLOAD TIME	6-45
UNDERVOLTAGE	6-49
UNDERVOLTAGE CTRL	6-26
USER MACRO IO CHG	6-23
User macros	5-9, 6-23

## W

WAKE UP LEVEL	6-64
Warnings	7-1
Warnings and Notes	i

## Z

ZERO SPEED LOAD	6-44
-----------------	------



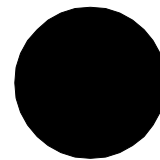

3AFY 61279008 R0325  
EFFECTIVE: 1.1.2001 EN

---

**ABB Industry Oy**

Drives  
P.O. Box 184  
FIN-00381 HELSINKI  
FINLAND  
Telephone: +358 10 22 2000  
Fax: +358 10 22 22681  
Internet: <http://www.abb.com/automation>

**ABB Automation Inc.**

Drives & Power Products  
16250 West Glendale Drive  
New Berlin, WI 53151  
USA  
Telephone: 262 785-8378  
800 243-4384  
Fax: 262 780-5135