

Table of Contents

Introduction	3
How to get going	4
System overview	9
Audio features	13
AM/FM	13
Satellite radio (if equipped)	15
CD	20
Auxiliary input jack (Line in)	22
DVD (if equipped)	22
Sound features	24
Speed compensated volume	26
Rear seat controls	26
System features	28
Date/time settings	29
Security	32
Help	33
MAP DVD - Loading and unloading	35
Cleaning map DVDs	37
Navigation features	38
Map icons	41
Destination entry	43
Previous destination	45
Address Book - destination entry	46
Point of Interest (POI)	48
Intersection	52
Freeway entrance/exit	53
Destination way points	55
Map preferences	57
Address Book - editing	59
Quick POIs	60
Avoid areas	60
Voice recognition	62

Table of Contents

Frequently asked questions	74
General Information	77
Index	82

All rights reserved. Reproduction by any means, electronic or mechanical including photocopying, recording or by any information storage and retrieval system or translation in whole or part is not permitted without written authorization from Ford Motor Company. Ford may change the contents without notice and without incurring obligation.

Copyright © 2006 Ford Motor Company

Introduction

NAVIGATION SYSTEM

Your vehicle is equipped with a navigation system which allows you to listen to the radio, play CDs, and also navigate the vehicle using a navigation map DVD.



Your system has a large range of features, yet is easy to use. Guidance is shown on the display screen and is supplemented with voice prompts. The display screen provides full information for operating the system through the use of tabbed menus, text screens, and map displays. Screen selections are made by touching the desired selection on the touch screen.

Introduction

DRIVING RESTRICTIONS

In order to prevent the navigation system from distracting the driver, access to certain functions are restricted when the vehicle is traveling above 5 MPH. (For example, only QUICK DEST (Destination) items are available for destination entry. Refer to *Destination Programming*). When the vehicle is in motion, the following functions are restricted:

- Scrolling of long lists
- Continuous scrolling of map
- Editing/Adding entries in the Address Book and Avoid Areas List
- DVD ROM Load and Eject

When the vehicle begins to move, and the Select Route Screen is shown, the highlighted route is automatically selected and guidance begins. When the vehicle speed is reduced to 5 MPH or less, system restrictions are lifted and you have full access to the system.

QUICK START

TO PLAY A RADIO STATION

1. Ensure that the navigation system is on.
2. Press MEDIA.



3. Select AM, FM1 or FM2.



4. Press TUNE to adjust manually up (▲) or down (▼) the frequency band.



5. Press SEEK to find the next strong station up (▲) or down (▼) the frequency band.



Introduction

TO PLAY SATELLITE RADIO (SR - IF EQUIPPED)

1. Ensure that the navigation system is on.
2. Press MEDIA.



3. If your vehicle is equipped with Satellite Radio, the SR tab will be present on the media screen. Select the SR tab to enter Satellite Radio mode (if equipped).



For further information on Satellite Radio, refer to *Satellite Radio* in the *Audio Features* chapter.

TO PLAY A PREVIOUSLY LOADED CD:

1. Ensure that the navigation system is on.
2. Press MEDIA.



3. Select the CD tab or press MEDIA repeatedly until CD is highlighted. Press the corresponding memory preset (1–6) to select the desired CD. The previously loaded CD will begin to play. The system will begin playing the discs in order.



Note: If there are no CDs loaded into the system, NO DISC will display in the status bar and you will not be able to highlight or select the CD tab.

4. Press SEEK to advance to the next (▲) or previous (▼) tracks.



Introduction

TO LOAD CDS:

1. Ensure that the navigation system is on.
2. Press LOAD.



3. When LOAD CD (#) appears on the status bar, select the desired slot by pressing the corresponding memory preset (1–6.)



4. Insert the disc. The CD will begin to play.

USING THE AUXILIARY INPUT JACK:

Your vehicle is equipped with an auxiliary input jack which allows a portable audio device to be listened to through your vehicle's audio system. To access the auxiliary input jack mode:

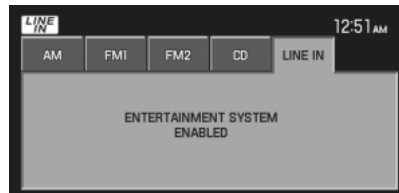

1. Press the MEDIA hard button.
2. Select the LINE IN tab.

Once a 3.5 mm input jack is plugged into the Line In jack, sound from the device will be emitted through the vehicle speakers.

For information on the auxiliary input jack location, please refer to *Auxiliary input jack* in the *Entertainment* chapter in your *Owner's Guide*.

Introduction

TO USE THE NAVIGATION SYSTEM:

1. Ensure that the vehicle ignition is on, and the navigation map DVD is loaded into the navigation map DVD player. If the navigation map DVD is not loaded, refer to *Loading and ejecting navigation map DVDs* in the *System Features* chapter for loading instructions.

2. Press DEST.



3. Select the desired type of destination entry: Quick Destination, Previous Destination, Address Book, POI, Address (shown), Map, Phone Number, Intersection or Freeway Entrance/Exit.



4. Enter the required information. Please note that:

- The system uses a Smart Speller, which facilitates entering information through the keyboard.
- Accented characters in English, Spanish and French will be converted internally to non-accented characters for search purposes.

5. The screen will show the point entered in a map. If this is the intended destination, press SET AS DESTINATION. COMPUTING ROUTE will display while the system is computing the route.

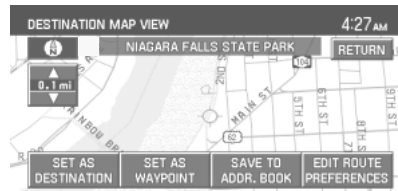

6. Select the desired route on the right hand side of the screen. There will be up to three routes possible from which to choose, each highlighted with a different color. For each route, the overall distance, route conditions and the estimated travel time are displayed.



7. Press START ROUTE and follow the instructions.

Introduction

VOICE RECOGNITION

Your navigation system is equipped with a voice activated feature that allows you to “speak” certain commands to the system. For further information, refer to *Voice recognition* in the *Navigation* chapter.

MENU TAB ARRANGEMENT

The 'tabs' that appear across the top of the screen will vary depending on your vehicle's options. For example, the 'SR' tab will appear if your vehicle is equipped with Satellite Radio. The FM tab also varies; and will be represented as FM or FM1 and FM2 depending on your vehicle's options.

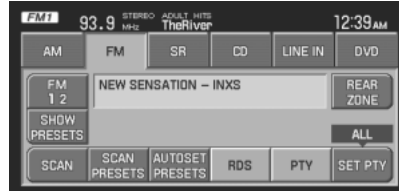

System overview

FORD AND MERCURY SYSTEM

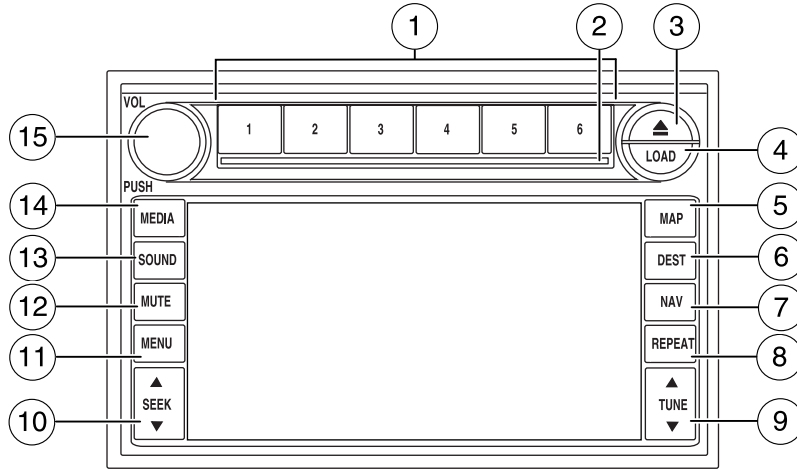

LINCOLN SYSTEM

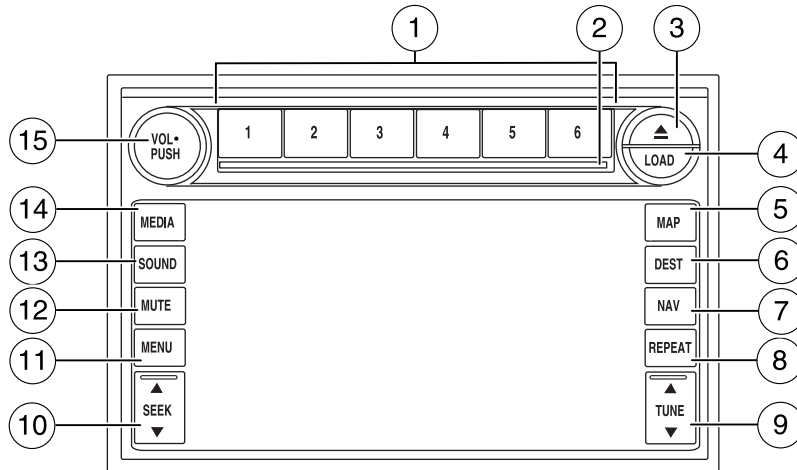

System overview

Refer to the System Overview graphics on the previous page.



1. **Memory presets:** To save a station (AM/FM1/FM2) in radio mode, tune to the selection. Press and hold the desired memory preset button (1–6). Press the memory preset buttons (1-6) to access your preset stations. In CD mode, press the memory preset buttons (1-6) to play the disc in the corresponding slot location.

2. **CD slot:** To load a CD: Press LOAD and a specific memory preset to load a CD to a specific slot. Once LOAD CD# appears in the display, the CD door will open. Insert the CD label side up.

3. **▲ (Eject):** Press the eject button to eject a single disc. Press and hold the button to eject all discs present in the system. To eject a specific disc, press the eject button and then press the corresponding memory preset button. If you do not select a specific disc, the system will automatically eject the disc that is currently playing.



4. **LOAD:** Press the load button to load a single disc. Press and hold the button to load discs in all empty slot locations.



5. **MAP:** Press to access the navigation map. Press while the map display is active to re-center the map on the current vehicle position. Press the button while the map display is active and a route is active to step through the different map guidance views.



6. **DEST (Destination):** Press to access the navigation destination entry menu. Press while in the navigation destination entry menu to show additional destination entry techniques.



7. **NAV (Navigation):** Press to access the navigation menu. Press while in the navigation menu to step through the navigation menu tabs.



System overview

8. **REPEAT:** Press the repeat button while navigation guidance is active to repeat the last spoken navigation guidance prompt.



9. **TUNE:** In radio mode, press ▲ TUNE ▼ to manually advance down or up the frequency band. In MP3 mode, press ▲ TUNE ▼ to advance to the previous/next folder.



Note: This feature requires a disc containing MP3 files organized in multiple folders.

10. **SEEK:** In radio mode, press SEEK ▲ / ▼ to seek to the next/previous available station. In CDX6 / DVD mode (if equipped), press SEEK ▲ / ▼ to change the next/previous track.



11. **MENU:** Press to access the system menu. Press while the system menu is active to step through the system menu tabs.



12. **MUTE:** Press to mute the playing media. Press again to return to the playing media.



13. **SOUND:** Press to access the Sound menu. Press while in the sound menu to step through the sound menu tabs.



14. **MEDIA:** Press to access the media menu. Press while in the media menu to step through the media menu tabs consisting of various sources.



System overview

15. **On/Off/Volume:** Press to turn the audio system on/off. Press and hold to turn the navigation radio completely off. Turn to adjust the volume of the audio system or the navigation voice prompts as they are being given.

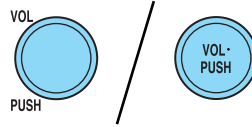

Note: If a route is active when the navigation radio is turned off, the route is resumed when the system is turned on again.

After the system initializes, the screen will be divided in two sections:

- **Status bar:** This is the top portion of screen that displays the clock or date and useful information, depending on current mode.
- **Display area:** The interactive screen that is activated by finger touch and changes depending on current system operation. Graphical buttons are displayed in this area depending on the current screen for the user to make choices.

Audio features

THX AUDIO SYSTEM — IF EQUIPPED (LINCOLN VEHICLES ONLY)

Your vehicle may be equipped with the THX® certified premium audio system. This system creates optimal acoustic quality for all seating positions and road conditions.

The system offers an advanced speaker system, amplifier, subwoofer and equalizer.



AM

1. Ensure that the navigation system is on.
2. Press MEDIA.
3. Select AM. Once in AM mode, you may select between SHOW OPTIONS and SHOW PRESETS.
4. Press SHOW OPTIONS to select from:

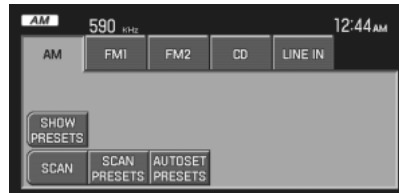

- **SCAN:** Press for a brief sampling of all listenable stations. Press again to disable and remain on the current selection.
- **SCAN PRESETS:** Press for a brief sampling of all the stations held in the memory presets.
- **AUTOSET PRESETS:** The autoselect feature allows you to set strong radio stations without losing your original preset stations. This feature is helpful on trips when traveling between cities with different radio stations. To enable, select AUTOSET PRESETS and the six strongest stations in your current area will be set as presets. To return to your original presets, press AUTOSET PRESETS again and the feature will disable.

Audio features

5. Press SHOW PRESETS to view the preset stations. To set or change a preset station, press and hold any of the memory presets buttons (1–6) or any of the soft key memory preset buttons on the screen while on the desired station. The new station will replace the previous one recorded.

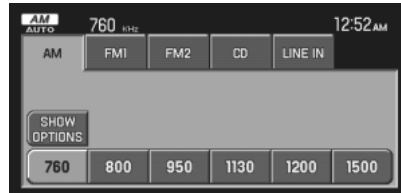

FM

1. Ensure that the navigation system is on.
2. Press MEDIA.
3. Select FM1 or FM2. Once in FM mode, you may select between SHOW OPTIONS and SHOW PRESETS.



4. Press SHOW OPTIONS to select from:



- **SCAN:** Press for a brief sampling of all listenable stations. Press again to disable and remain on the current selection.
- **SCAN PRESETS:** Press for a brief sampling of all the stations held in the memory presets.
- **AUTOSET PRESETS:** The autoselect feature allows you to set strong radio stations without losing your original preset stations. This feature is helpful on trips when traveling between cities with different radio stations. To enable, select AUTOSET PRESETS and the six strongest stations in your current area will be set as presets. To return to your original presets, press AUTOSET PRESETS again and the feature will disable.
- **RDS:** This feature allows the radio system to receive text information from RDS-equipped FM radio stations. In FM mode, press RDS to activate/deactivate. RDS must be activated in order to access PTY and SET PTY.
- **PTY:** This feature allows the user to search for Radio Data System (RDS) stations selectively by their program type. To be able to select this feature, RDS must be enabled. PTY and station call letters will be displayed on the Status Bar.

Audio features

- **SET PTY:** Press to select a program type, which, once selected, will be displayed above the SET PTY button. Once PTY has been programmed, press SEEK or SCAN to initiate a search up or down the frequency. The search will stop when the desired program type has been reached.

Note: The system will scan the frequency band three times for the chosen program type. If the program type is unavailable in your reception range, the system will return to the previous station.

5. Press SHOW PRESETS to view the preset stations. To set or change a preset station, press and hold any of the presets while on the desired station. The new station will replace the previous one recorded.



SATELLITE RADIO (IF EQUIPPED)

Your vehicle may be equipped with Satellite Radio capability. Vehicles that are equipped with a factory installed SIRIUS Satellite Radio system include a limited subscription term which begins on the date of sale/lease of the vehicle. Extended subscription terms are available, please contact SIRIUS at 1-888-539-7474.

You will need to give SIRIUS your Satellite Radio ESN Number for activation. The ESN number is found on the System Information Screen in the lower left corner (SR ESN:XXXXXXXXXXXX). If the SYSTEM INFO screen is not available, press MENU to access the system information.

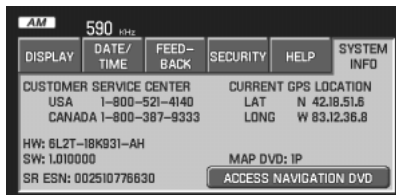

For further information on satellite subscription and service, refer to *Satellite radio information* later in this chapter.

Audio features

SATELLITE RADIO INTERACTION (IF EQUIPPED)

Once the Satellite Radio feature is activated, your navigation system will have additional features.

Press SR to enter Satellite Radio Mode.

- **SR123:** You will be able to access three different Satellite Radio bands, SR1, SR2 and SR3. You can save six presets on each band, for a total of 18 presets.



- **SCAN:** Press to hear a brief sampling of Satellite Radio channels. Press again to stop. When a scan is active, the system will only scan stations available in the selected genre setting.
- **SCAN PRESETS:** Press to hear a brief sampling of all preset stations.
- **TEXT:** Press once to display artist and title information. Press again to display album and genre information.
- **KEYPAD:** Press to display the numeric keypad (0–9). Use the keypad to manually enter a desired channel. Press ENTER to confirm the selection, or press BACK to delete the entered numbers.
- **SHOW PRESETS/SHOW OPTIONS:** Press to toggle between displays of the functional buttons or presets at the bottom of the screen.

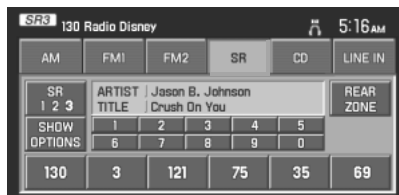

- **CHANNEL GUIDE:** Press to display the list of satellite radio channels from 1–184. Press the SKIP button located next to the listed channel in order to block that station from being selected when tune, seek or scan searches are active.

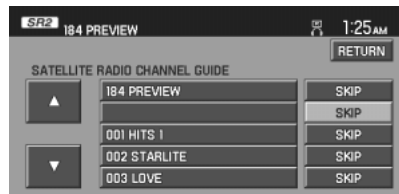

Note: You will not be able to scroll through the channel guide when the vehicle is in motion.

Audio features

- **GENRE:** Press to scroll through a variety of different format types.

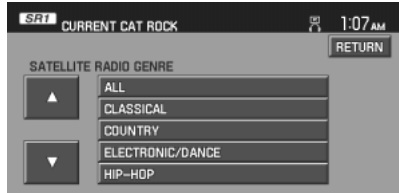

- **REAR ZONE:** Press to enable/disable the rear controls, turn the headphones on/off and to select from different media sources.

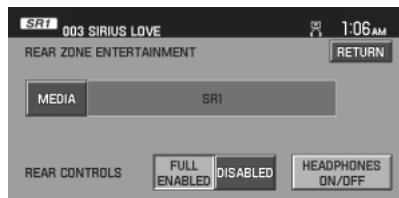

SATELLITE RADIO INFORMATION (IF EQUIPPED)

Satellite radio channels: SIRIUS broadcasts a variety of music, news, sports, weather, traffic and entertainment satellite radio channels. For more information and a complete list of SIRIUS satellite radio channels, visit www.sirius.com in the United States, www.sirius-canada.ca in Canada, or call SIRIUS at 1-888-539-7474.

Satellite radio reception factors: To receive the satellite signal, your vehicle has been equipped with a satellite radio antenna located on the roof of your vehicle. The vehicle roof provides the best location for an unobstructed, open view of the sky, a requirement of a satellite radio system. Like AM/FM, there are several factors that can affect satellite radio reception performance:

- **Antenna Obstructions:** For optimal reception performance, keep the antenna clear of snow and ice build-up and keep luggage and other material as far away from the antenna as possible.
- **Terrain:** Hills, mountains, tall buildings, bridges, tunnels, freeway overpasses, parking garages, dense tree foliage and thunderstorms can interfere with your reception.
- **Station overload:** When you pass a ground based broadcast repeating tower, a stronger signal may overtake a weaker one and result in an audio mute.

Unlike AM/FM audible static, you will hear an audio mute when there is a satellite radio signal interference. Your radio display may display NO SIGNAL to indicate the interference.

Audio features

SIRIUS satellite radio service: SIRIUS Satellite Radio is a subscription based satellite radio service that broadcasts music, sports, news and entertainment programming. A service fee is required in order to receive SIRIUS service. Vehicles that are equipped with a factory installed SIRIUS Satellite Radio system include:

- Hardware and limited subscription term, which begins on the date of sale or lease of the vehicle.
- Online media player providing access to all 65 SIRIUS music channels over the internet (U.S. customers only).

For information on extended subscription terms, contact SIRIUS at 1-888-539-7474.

Note: SIRIUS reserves the unrestricted right to change, rearrange, add or delete programming including canceling, moving or adding particular channels, and its prices, at any time, with or without notice to you. Ford Motor Company shall not be responsible for any such programming changes.

Satellite Radio Electronic Serial Number (ESN): This 12 digit Satellite Serial Number is needed to activate, modify or track your satellite radio account. You will need this number when communicating with SIRIUS. While in Satellite Radio mode, you can view this number by pressing the MENU hard button and then selecting SYSTEM INFO. The number will appear in the bottom left corner of the screen. For further information, please refer to *System information* in the *System features chapter* of this navigation supplement.

Radio Display	Condition	Action Required
ACQUIRING	Radio requires more than two seconds to produce audio for the selected channel.	No action required. This message should disappear shortly.
SAT FAULT	Internal module or system failure present.	If this message does not clear within a short period of time, or with an ignition key cycle, your receiver may have a fault. See your authorized dealer for service.

Audio features

Radio Display	Condition	Action Required
INVALID CHNL	Channel no longer available.	This previously available channel is no longer available. Tune to another channel. If the channel was one of your presets, you may choose another channel for that preset button.
UNSUBSCRIBED	Subscription not available for this channel.	Contact SIRIUS at 1-888-539-7474 to subscribe to the channel, or tune to another channel.
NO TEXT	Artist information not available.	Artist information not available at this time on this channel. The system is working properly.
NO TEXT	Song title information not available.	Song title information not available at this time on this channel. The system is working properly.
NO TEXT	Category information not available.	Category information not available at this time on this channel. The system is working properly.

Audio features

Radio Display	Condition	Action Required
NO SIGNAL	Loss of signal from the SIRIUS satellite or SIRIUS tower to the vehicle antenna.	You are in a location that is blocking the SIRIUS signal (i.e., tunnel, under an overpass, dense foliage, etc). The system is working properly. When you move into an open area, the signal should return.
UPDATING	Update of channel programming in progress.	No action required. The process may take up to three minutes.
CALL SIRIUS 1-888-539-7474	Satellite service has been deactivated by SIRIUS Satellite Radio.	Call SIRIUS at 1-888-539-7474 to re-activate or resolve subscription issues.

CD

To load a CD:

1. Press LOAD.



Note: CD units are designed to play commercially pressed 4.75 in (12 cm) audio compact discs only. Due to technical incompatibility, certain recordable and re-recordable compact discs may not function correctly when used in CD players. Irregular shaped CDs, CDs with a scratch protection film attached, and CDs with homemade paper (adhesive) labels should not be inserted into the CD player. The label may peel and cause the CD to become jammed. It is recommended that homemade CDs be identified with permanent felt tip marker rather than adhesive labels. Ballpoint pens may damage CDs. Please contact your authorized dealer for further information.

2. Select the desired slot by pressing the corresponding memory preset button (1-6).



20

Audio features

3. Insert the disc, label side up, when LOAD CD# appears in the status bar. The CD will begin to play.

The following functions are available in CD mode:



- **SEEK:** In CD or MP3 mode, press to listen to the next (▲) or previous (▼) track. In MP3 mode with FOLDER MODE selected, press SEEK to advance to the first track in the same folder.
- **TUNE:** In MP3 mode, press to advance to the next (▲) or previous (▼) folder.
- ◀◀ (Reverse): Press to step back through current track.
- ▶ / || (Play/Pause): Press to play or pause the current track.
- ▶▶ (Fast forward): Press to advance through the current track.
- **SCAN:** In CD mode, press to hear a brief sampling of all tracks on the current CD. In MP3 mode, press for a brief sampling of all tracks in all folders.
For an MP3 disc with multiple folders, pressing FOLDER MODE when running a scan will result in brief sampling of all songs in the current folder.
- **COMP** (Compression): Press to engage the compression feature. COMPRESSION boosts more quiet music and lowers louder music to minimize the need for volume adjustments. Press again to disengage.
- **REPEAT:** Press to repeat the current track. REPEAT will appear in the Status Bar when selected. Press again to disengage.
- **SHUFFLE:** Press to engage the shuffle feature. When playing MP3 files, if FOLDER MODE is engaged, the system will shuffle the songs within the current folder only; otherwise, it will shuffle all the tracks in the disc. Press again to disengage.
- **FOLDER MODE:** Press to play only the tracks in the current folder, when playing MP3 files arranged in separate folders.
- **TEXT:** When available, displays information from the CD.

Audio features

AUXILIARY INPUT JACK (LINE IN)

Your vehicle is equipped with an audio input jack which will allow a portable audio device to be listened to through your vehicle's audio system. To activate this feature and access the LINE IN screen:

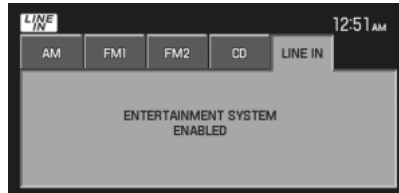

1. Press the MEDIA hard button.
2. Select the 'Line In' tab.

Once a 3.5 mm input jack is plugged into the Line In jack, sound from the device will be emitted through the vehicle speakers.

For information on the auxiliary input jack location, please refer to the *Auxiliary input jack* in the *Entertainment* chapter of your *Owner's Guide*.

DVD (IF EQUIPPED)

Your vehicle may be equipped with a DVD player. The navigation system can provide you interaction with the DVD system in the rear of the vehicle. To access the DVD screen:

1. Ensure that the navigation system is ON.

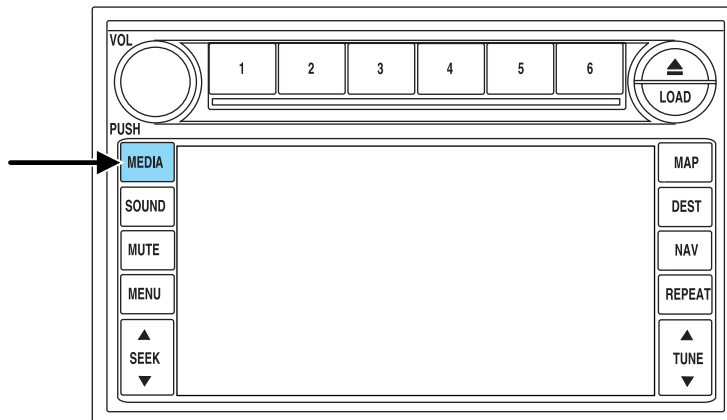

2. Press MEDIA.

Audio features

3. If your vehicle is equipped with a DVD player, DVD will appear as a tab selection in the media screen. The DVD screen will allow you to select from the following options:



- **◀◀** (Reverse): Press for reverse play.
- **▶/||** (Play/Pause): Press to play or pause the DVD.
- **▶▶** (Fast forward): Press for advance play.
- **REAR AUX** : Press to access rear auxiliary mode. There is an external video/audio input for the rear seat passengers to connect to an external DVD player, video games, etc.
- **REAR ZONE**: Press to access the Rear Zone Entertainment Screen. This screen allows back seat passengers to select/listen to a different audio/video source than the front seat passengers. The only restriction being the front and back seat passengers cannot both listen to a different frequency band (AM/FM1/FM2).

SEEK: You may press SEEK on the bezel for the next (▲) or previous (▼) chapter.

4. The screen will show you the selected playing media of the different headsets (A and B). To make adjustments, ensure that the correct headset (A or B) is highlighted. The appropriate controls will appear to allow you to make adjustments to your current playing media.



- **MEDIA**: Press to select the desired media in the selected headset (A or B).
- **FULL ENABLED**: When active, rear seat passengers can select any audio/video source for the A headset (B headset can only choose from DVD and DVD AUX). If the front seat passengers are listening to the radio, the rear seat passengers can also select to listen to the radio and will have control to change the radio station or Satellite Radio channel.

Audio features

- **REAR ONLY:** When active, rear seat passengers can select any audio/video source for the A headset (B headset can only choose from DVD and DVD AUX). If the front seat passengers are listening to the radio, the rear seat passengers can also select to listen to the radio but will not have control to change the radio station or Satellite Radio channel.
- **DISABLED:** When active, all features for the rear seat passengers are disabled. REAR ZONE OFF will be displayed in front of the A and B buttons. The audio selection of the front seat will play through all speakers. At any time the rear seat passengers can turn on the Family Entertainment System (FES), if equipped, through the DVD player. At that point, the navigation system will automatically display REAR ZONE ENTERTAINMENT and enable the headsets. The primary selection for the front seat will change to DVD.
- **HEADPHONES ON/OFF:** Press to turn the headphones on/off.

SOUND FEATURES

The sound menu allows you to access settings such as Bass, Treble, Fade, Balance, Digital Signal Processing (DSP) and Speed Compensated Volume (SCV).

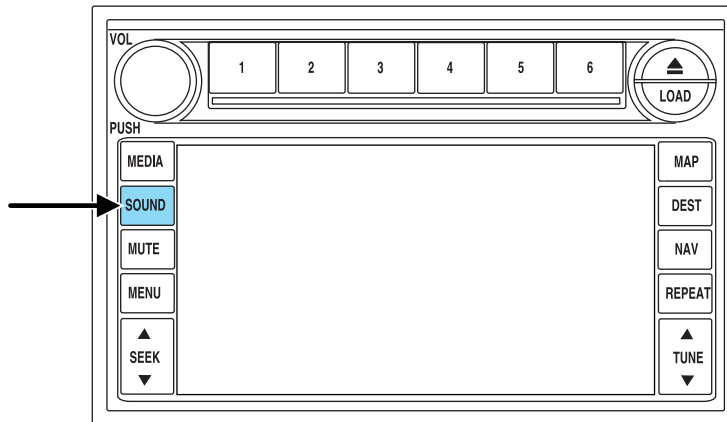

1. To access the sound features, press SOUND. The sound screen will appear.

Audio features

2. Press the appropriate tab to select from:

BASS/TREBLE: Press + to increase or — to decrease the level of bass/treble.

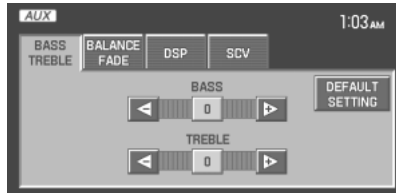

BALANCE/FADE: Press ◀ / ▶ to adjust the sound between the left and right speakers (Balance) and ▲ / ▼ to adjust the sound to the front and rear speakers (Fade).



DSP (Digital Signal Processing): Press to optimize the sound quality for ALL SEATS, DRIVER, REAR or CONVERTIBLE (if equipped). If THX equipped, optimization is available for ALL SEATS, DRIVER or FRONT.

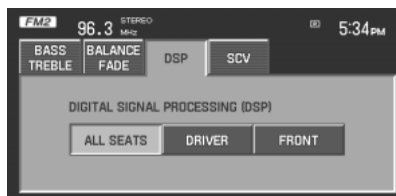

SCV (Speed Compensated Volume): Radio volume changes automatically with vehicle speed to compensate for road and wind noise. You may turn the feature on/off, and select a level of compensation between 1 and 7 by pressing the corresponding button.

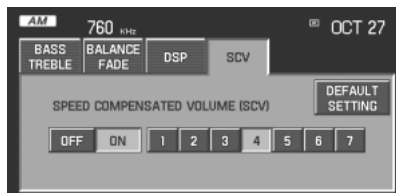

DEFAULT SETTING: Press to clear out any current settings and return the system to the default settings.

Note: Please refer to your *Owner's Guide* for further information.

Audio features

REAR SEAT CONTROLS

Your vehicle is equipped with Rear Seat Controls. To access the Rear Zone screen through your Navigation system:

1. Ensure that the navigation system is ON.

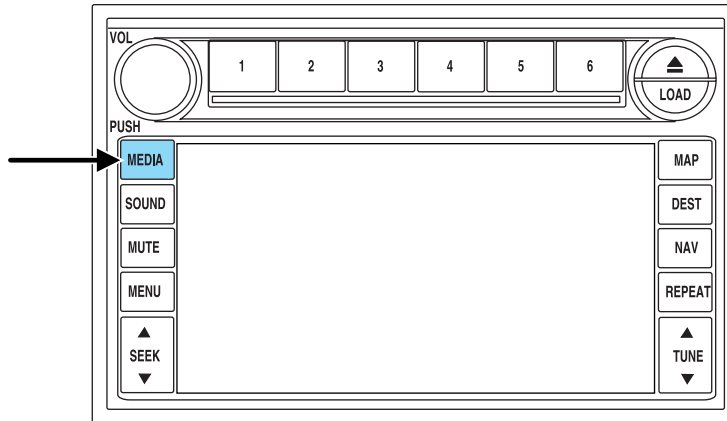

2. Press MEDIA.
3. Press REAR ZONE on the AM, FM, CD or SR media screens.

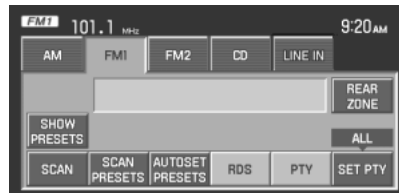

Audio features

4. The screen will show you the selected playing media. The appropriate controls will appear to allow you to make adjustments to your current playing media.



- **HEADPHONES ON/OFF:** Press to turn the headphones on/off.
- **REAR ZONE:** Press to turn the Rear Zone off.
- **MEDIA:** If the headphones are ON, press the media button to select between Radio and Rear AUX.
- **FULL ENABLED:** When active, rear seat passengers can select any audio/video source. If the front seat passengers are listening to the radio, the rear seat passengers can also select to listen to the radio and will have control to change the radio station or Satellite Radio channel.
- **REAR ONLY:** When active, rear seat passengers can select any audio/video source. If the front seat passengers are listening to the radio, the rear seat passengers can also select to listen to the radio but will not have control to change the radio station or Satellite Radio channel.
- **DISABLED:** When active, all features for the rear seat passengers are disabled. REAR ZONE OFF will be displayed. The audio selection of the front seat will play through all speakers. At any time the rear seat passengers can turn on the Family Entertainment System (FES), if equipped, through the DVD player. At that point, the navigation system will automatically display REAR ZONE ENTERTAINMENT and enable the headsets. The primary selection for the front seat will change to DVD.

For more information, please refer to *Rear seat controls* in your *Owner's Guide*.

System features

DISPLAY

To access the display settings:

1. Ensure that the navigation system is ON.

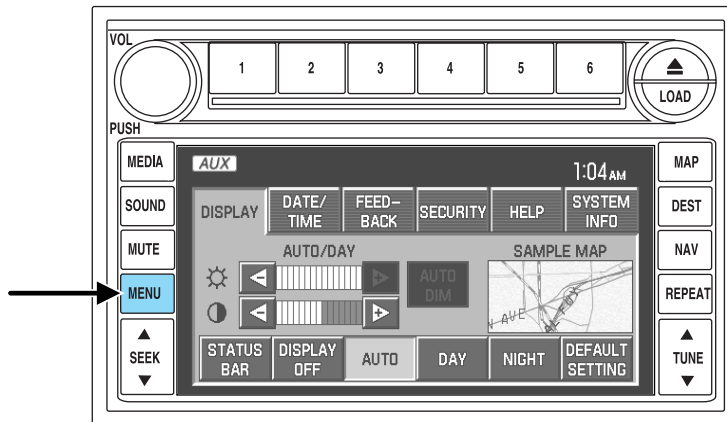

2. Press MENU. The Menu screen will display.
3. Press DISPLAY. You may then select from the following options:
 - **AUTO DIM:** Select to automatically dim the display brightness with the vehicle backlighting (when headlights are turned on). Otherwise, display brightness can be manually adjusted.
 - **STATUS BAR:** Press to display only the Status Bar until the screen is touched again. Refer to *Status Bar Description* in Basic Operation.
 - **DISPLAY OFF:** Press to turn off the entire screen. Press the screen or any hard button to turn the display on again.
 - **AUTO:** Press to set the display to automatic mode. When headlights are turned on, the system will automatically switch to the night display screen. To adjust brightness or contrast, press + or — .
 - **DAY:** Press to select the day screen. To adjust brightness or contrast, press + or — .
 - **NIGHT:** Press to select the night screen display. To adjust brightness or contrast, press + or — .

System features

- **DEFAULT SETTING:** Press to clear any current settings and return to the system default.
- **SAMPLE MAP:** Shows you how the map will appear with the current settings

DATE/TIME

To access the date/time settings:

1. Ensure that the navigation system is ON.

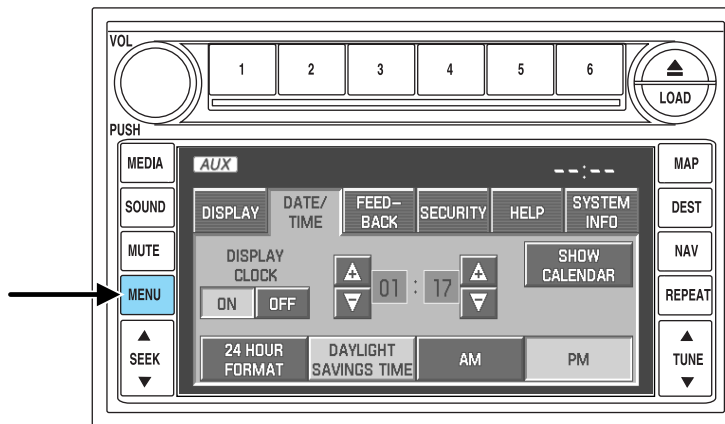

2. Press MENU. The Menu screen will display.
3. Press DATE / TIME. You may then select from the following options:
 - **SHOW CLOCK / SHOW CALENDAR:** Press to toggle between CLOCK and CALENDAR screens. Under the CLOCK screen, the following buttons will be available:
 - **CLOCK ON/OFF :** Press ON to enable the clock display in the status bar. Press OFF to disable the clock display in the status bar.
 - **TIME SET BUTTONS:** Press + or - to adjust the hours and minutes.
 - **24 HOUR FORMAT:** If enabled, the system will display military time. If disabled, the user must select AM or PM.
 - **DAYLIGHT SAVINGS TIME (if equipped):** Automatically prompts you to adjust the clock according to the daylight savings calendar.
 - **SHOW CALENDAR:** Press to display the calendar screen.

System features

The calendar screen will display the current month. Press PREV to view the previous month or NEXT to view the next month. Under the CALENDAR screen, the following buttons are available:



- **GO TO TODAY:** Press to highlight the current date.
- **SHOW CLOCK:** Press to return to the clock screen.

FEEDBACK

To access the feedback screen:

1. Ensure that the navigation system is ON.

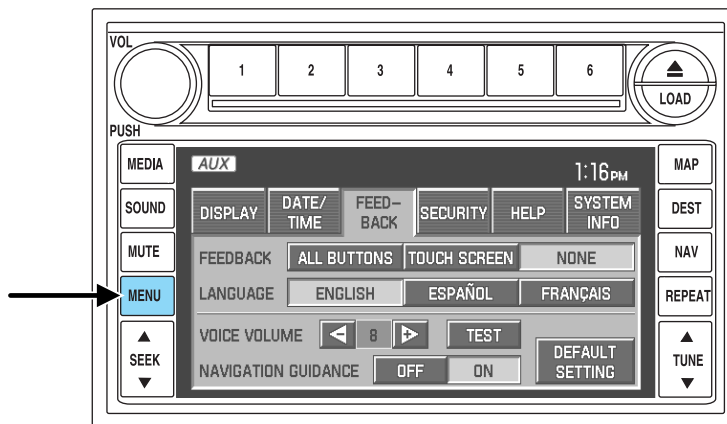

2. Press MENU. The Menu screen will display.

System features

3. Press **FEEDBACK**. The feedback screen will appear. In this screen you have the following options:

FEEDBACK: One must be selected at all times:

- **ALL BUTTONS:** Press to hear an audible beep every time any button on the system is pressed.
- **TOUCH SCREEN:** Press to hear an audible beep when any touch screen button is pressed.
- **NONE:** Press to turn off all audible beeps. You may press any button and no beeps will be heard.

LANGUAGE: One must be selected at all times:

- **ENGLISH:** Press to set the system language to English.
- **ESPAÑOL:** Press to set the system language to North American Spanish.
- **FRANCAIS:** Press to set the system language to North American French.

Note: The system will automatically restart after a new language is chosen.

VOICE VOLUME: Press +/- to select voice prompt volume level (1–34). You may also turn the volume control during a voice prompt to adjust the volume level.

TEST: Press to hear an audio sample of voice prompt at the currently selected volume.

NAVIGATION GUIDANCE: Press ON to hear navigation guidance voice prompts. Press OFF to turn the voice prompts off.

DEFAULT SETTING: Press to clear any current settings and return to the system default settings.

System features

SECURITY

Your navigation system has a special security feature which allows you to enable the valet mode. In valet mode, if your vehicle is being parked by a valet, they will be unable to access any of the navigational information (addresses, destinations, etc.), change any settings or eject any CDs or the navigation DVD. To access and enable valet mode:

1. Ensure that the navigation system is on.

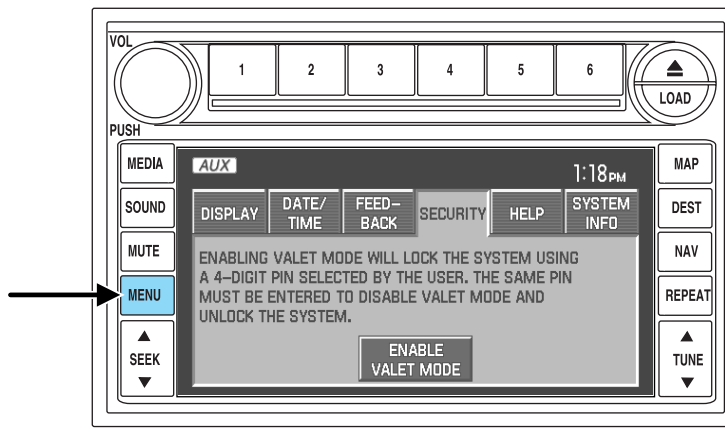

2. Press MENU.
3. Press SECURITY.
4. Press ENABLE VALET MODE to lock the system using any 4-digit PIN (Personal Identification Number). When valet mode is activated, the system will be completely locked. The PIN must be entered in order to disable Valet Mode and unlock the system. You can select a different PIN every time the system needs to be locked. If the PIN is forgotten, you can disable Valet Mode by disconnecting the battery or removing the appropriate fuse for one minute to reset the system.

System features

HELP

Your system has a special help feature. To access the help feature:

1. Ensure that the system is on.

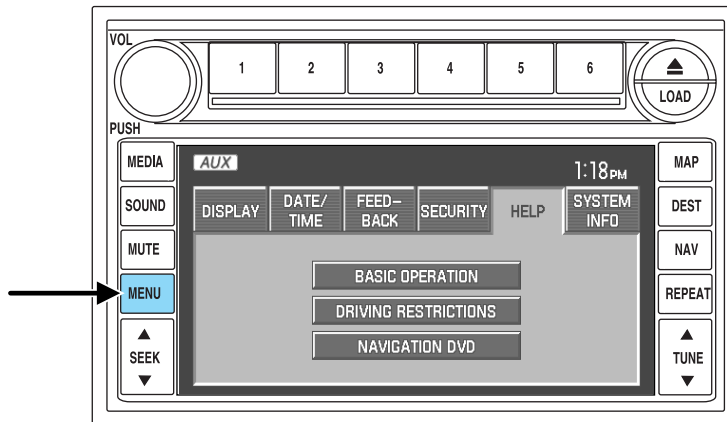

2. Press MENU.
3. Press HELP. You may then select from:
 - **BASIC OPERATION:** This screen will provide basic help with the hard buttons on the system, providing a brief description for each button.
 - **DRIVING RESTRICTIONS:** This screen will inform you that due to driver distraction and safety concerns, certain features will be restricted when the vehicle is in motion.
 - **NAVIGATION DVD INFORMATION:** Press to access information on the navigation map DVD — basic operation , how to access the DVD, and also replacement and contact information for the Customer Relationship Center.

System features

SYSTEM INFORMATION

The system information screen gives you contact information, current location and access to the Navigation DVD. To access the System Information screen:

1. Ensure that the system is on.

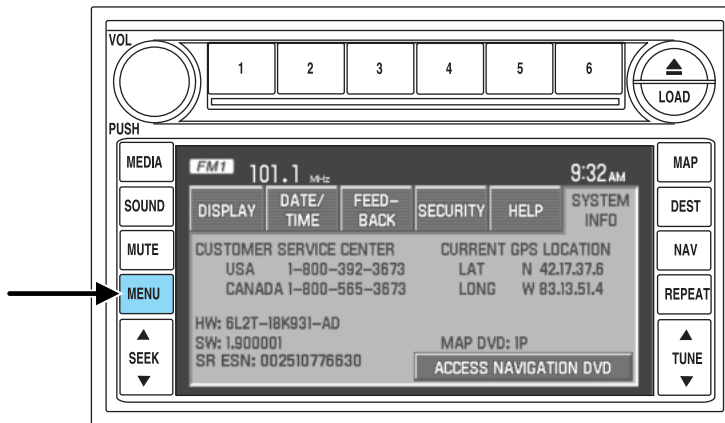

2. Press MENU.
3. Press SYSTEM INFO to view the following information:
 - Customer Relationship Center (shown as "Customer Service Center") phone numbers in USA and Canada
 - Current GPS Location
 - Map DVD Release Version
 - ACCESS NAVIGATION DVD: Press to access the Navigation Map DVD from this screen.
 - Satellite Radio Electronic Serial Number (ESN#)

System features

LOADING AND EJECTING NAVIGATION MAP DVDS

1. Ensure that the system is on.

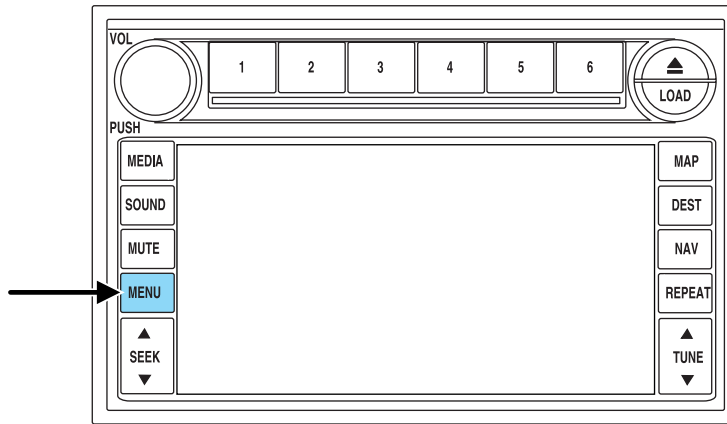

2. Press MENU.
3. Press SYSTEM INFO.
4. Press ACCESS NAVIGATION DVD. The following disclaimer will appear:

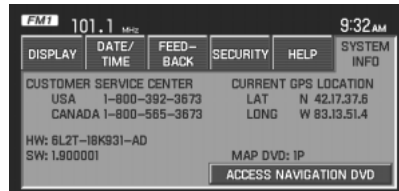

“To access the navigation DVD, select the OPEN button. This will cause the display to open. If the navigation DVD is installed, it will be ejected automatically. The screen will close automatically when a disc is inserted, or if no activity is detected for 5 minutes.”

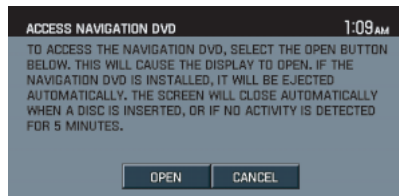

System features

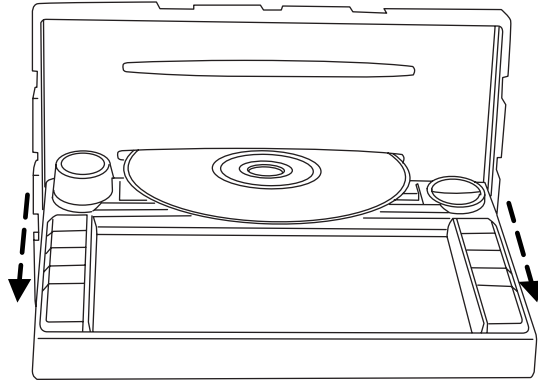

5. Press OPEN. The navigation screen will fold down, allowing you to access the navigation DVD slot. Insert the DVD with the printed side up into the lowest slot. If you do not wish to change the DVD, simply reinsert the DVD and the system will close automatically. Do not allow moisture or foreign objects to enter the slot. The system then will check the disc inserted. If valid, it will install the software and restart the system.

If you do not wish to access the DVD, press CANCEL.

LATEST MAP DVDS

The map content is constantly changing due to new roads, traffic, restrictions, etc. Therefore, it is not always possible to exactly match the DVD map with the current roadways. For best results, always use the latest version of the map DVD. Map information is regularly updated, but all areas are not necessarily covered to the same level of detail. Some areas, in particular private roads, may not be included on the MAP DVD. To help with accuracy, always use the latest DVD version for navigation. Updates to the database will have no effect on the contents of the address book and other user settings. Loading an older version of the map DVD may result in data loss.

System features

CLEANING MAP DVDS

Note: Ensure that you handle the high density digital map DVD with care and by the edges only. Fingerprints, smudges and scratches on the disc can affect Navigation System performance.

1. Ensure that you use a soft, non-abrasive, lint-free cloth.
2. DO NOT clean the disc in a circular motion as this may harm the pits on the surface of the disc.
3. In order to minimize any scratching, wipe the disc with the cloth from the inner hub to the outside of the disc.
4. DO NOT use any type of liquid cleaning solutions on the discs.

ORDERING ADDITIONAL MAP DVDS

If you wish to order a replacement map, an additional map, or an updated DVD, in the United States, please contact:

- Ford Customer Relationship Center at 1 (800) 392-3673 (FORD)
- Lincoln Mercury Customer Service Center at 1 (800) 521-4140

In Canada, please contact:

- Ford Customer Relationship Centre at 1 (800) 565-3673 (FORD)
- Lincoln Customer Service Centre at 1 (800) 387-9333

Navigation features

DISCLAIMER

After each ignition cycle, a disclaimer display will appear. Press AGREE to the content of the screen in order to access the navigation functions. If you do not press AGREE, you will only have access to non-navigation functions.

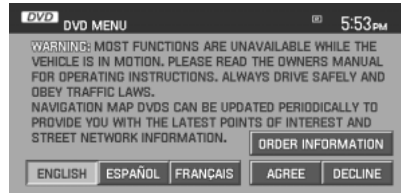

MAP MODE

To enter map mode:

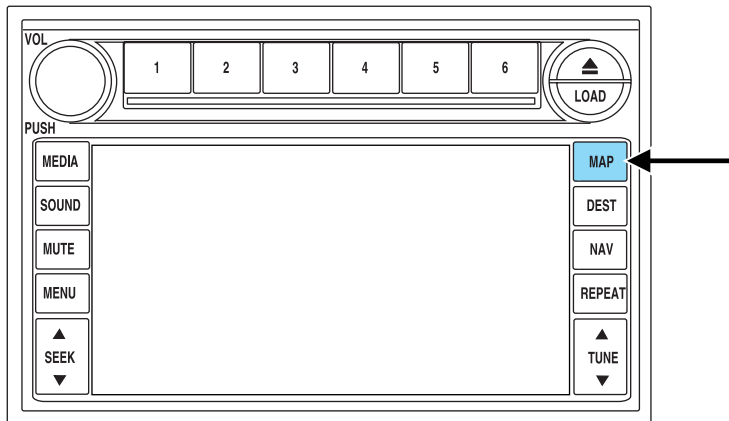

1. Ensure that the system is on.



2. Press MAP. The map screen will display.

Navigation features

When in MAP mode, an icon appears on the upper left side of the screen; this is a toggle button to change the view of the map displayed. The following methods exist for orientation of the map:

- **Heading up:** In this mode, the direction of forward travel is always upward direction on screen. Available for map scales up to 2.5 mi/5km. For scales above that, the setting for Heading-Up is remembered, but the map is shown in North-Up only. If the scale returns below this level, then the Heading-Up setting is restored. 
- **North up:** In this mode, the Northern Direction is always upward direction on screen. 

MAP SCALE

The map display scale on the map has 16 levels, ranging from 0.02 miles to 1000 miles. In MAP mode, you can also zoom in or out, changing the display scale by

pressing on one of the arrows on the button appearing on the left side of the screen. When in Full Screen Map Mode, touching this button will cause the Zoom Direct buttons to appear. The Zoom Direct buttons represent the most common scales and can be pressed directly to show the map at the desired scale. 

Map road colors and building representation on the map:

- **Roads:** Will be displayed in a variety of colors. Specifically, pink roads are not able to be used as routes. Also, purple roads indicate roads under construction currently or at the time of disc compilation. These roads will be open in the future.
- **Building footprints:** Will display areas of major buildings in the 20 largest cities in the U.S. These areas will be displayed depending on their size and the map zoom level.

Navigation features

- **EDIT ROUTE:** Press in order to adjust the following features of the current route:

DETOUR: Press to select a portion of the route for the navigation system to avoid. Select the desired distance (between one and 100 miles) of the current road. A map for each alternative route will display on the screen. Select the desired route.

EDIT TURN LIST: Press to display the TURN LIST screen and make any desired adjustments. Refer to *Turn list*.

EDIT ROUTE PREFERENCES: Press in order to change settings for route searches. Refer to *Route preferences*.

EDIT DESTINATION/WAYPOINTS: Press in order to add, delete or adjust any waypoints or your destination. Refer to *Destination/Waypoints list*.

- **CANCEL ROUTE:** Press to delete the next waypoint or the whole current route. The route cannot be deleted while a reroute is in progress.

Note: Once deleted, you will not be able to restore the waypoint or route.

MAP SCROLLING

Single scroll: In single scroll mode, press and release on the map display will bring the pressed position to the center of the screen. The scroll mode will time out after five minutes of inactivity.







Continuous scroll: During scroll mode, press and hold to begin scrolling continuously in one of eight directions closest to the point that is pressed. The scroll will continue until the map is released, and will increase in speed after three seconds. This is not possible if the vehicle is moving. The scroll mode will time out after five minutes of inactivity.

MAP ICON DESCRIPTIONS

- **Vehicle mark:** This icon is shown in scroll mode also. The ring around the vehicle mark will flash. The vehicle mark is shown in the center of the map display, except when in scroll mode.
- **Scroll cursor:** This icon is fixed in the center of the screen. The map position closest to the cursor is in a window on the top center part of the screen.

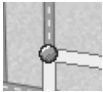

Navigation features

- **Address book entry default icon:** This icon indicates the location on the map of an address book entry. This is the default symbol shown after the entry has been stored to the Address Book by any method other than the map. A different icon can be selected from the 12 icons available; each icon can be used more than once. Refer to *Address book*.

- **Home:** This icon indicates the location on the map currently stored as the home position. Only one entry from the Address Book can be saved as Home. This icon cannot be changed.

- **POI (Point Of Interest) icon:** Icons such as this can be displayed on the map and can be turned on or off. There are about 56 subcategories of POIs that can be selected to be displayed on the map one at a time.

- **Waypoints:** This icon indicates the location of a waypoint on the map. The number inside the circle is different for each waypoint and represents the position of the waypoint in the route list.

- **Destination symbol:** This icon indicates the location of the final destination on the map.

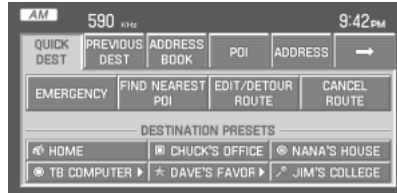
- **Next maneuver point:** This icon shows the location where the next turn should occur on the planned route. You may be able to see up to the next three turns.

- **No GPS symbol:** This icon indicates that insufficient GPS satellite signals are being received for accurate map positioning. The symbol may be intermittently displayed under normal operation in an area with poor GPS access. Refer to *Limited GPS reception* in General Information.

Navigation features

DESTINATION PROGRAMMING

Press DEST to set a destination.

There are nine ways to program a destination. Most of these will be restricted when the vehicle is in motion. One tab for each method will appear on the screen when DEST is pressed. An additional tab with the symbol → or ← will be displayed for additional methods. When entering a destination, the system uses a Smart Speller, which facilitates entering information through the keyboard.



Note: The system will not calculate a route to a destination that is located on the same block as the vehicle's current location.

QUICK DESTINATION

Press the Quick Destination tab to view the possible destination choices when the vehicle is in motion.

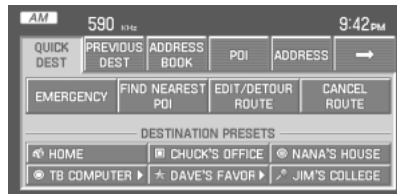

- **EMERGENCY:** There are two categories of Hospital and Police that can be selected under the Emergency category. They can be searched for in order of their distance from the vehicle's current location. The maximum length for the search result will be 25 items.



Navigation features

- **FIND NEAREST POI:** You can select five POI categories at a time. Of these five possible, you can search for one at a time in the vicinity of the vehicle position. The defaults for these five categories are shown in the graphic, and can be changed. Refer to *Quick POIs*.



Once one of these categories is selected, a list of matches will be shown in order of distance from the current location.

LIST ALL CATEGORIES: When selected, a list of categories will be shown. When one is selected, a list of subcategories will appear. After selecting a subcategory, a search will show a list with name and distance to each POI from the vehicle position. Once a location is selected, the system will display the Destination map screen for confirmation.



- **DESTINATION PRESETS:** Displays the home location and five entries selected from the Address Book. The icon and the name associated with the location will appear. Refer to *Address Book*.

When a route has been initiated, the following buttons become available under the QUICK DEST tab:

- **EDIT/DETOUR ROUTE:** Gives you the following options to change features of the current route:

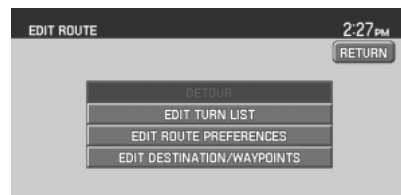

DETOUR: Press to select a portion of the route for the navigation system to avoid. Select the desired distance (between one and 100 miles) of the detour. A map for each alternative route will display on the screen. Select the desired route.

EDIT TURN LIST: Press to display the TURN LIST screen and make any desired adjustments. Refer to *Turn list*.

EDIT ROUTE PREFERENCES: Press in order to change settings for route searches. Refer to *Route preferences*.

Navigation features

EDIT DESTINATION/WAYPOINTS: Press in order to add, delete or adjust any waypoints or your destination. Refer to *Destination/Waypoints list*.

- **CANCEL ROUTE:** Press to delete the next waypoint or the whole current route. The route can be deleted while a reroute is in progress.

PREVIOUS DESTINATION

Your navigation system will allow you to select from a list of the 20 most recent destinations and waypoints. Once the list is full, any newly added items overwrite the oldest ones on the list. To access your previous destinations/waypoints:

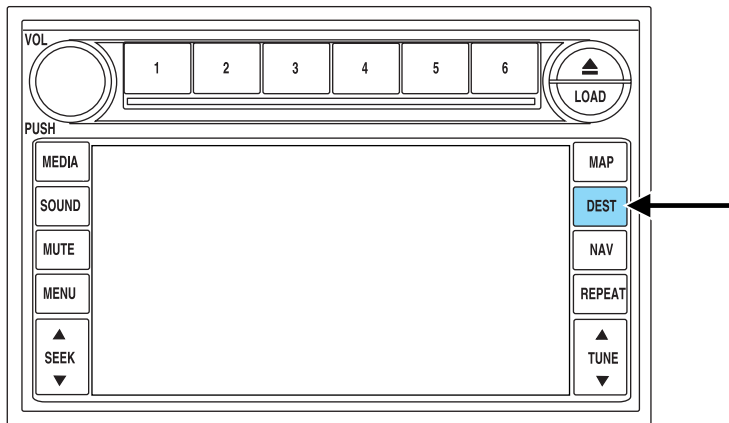

1. Press DEST.
2. Select PREVIOUS DESTINATION.

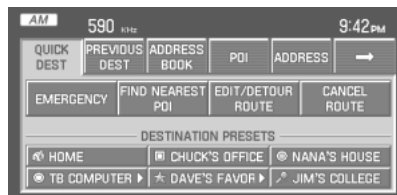

Navigation features

3. You may now scroll through the list of previous destinations using the ▲ / ▼ soft keys. Once you have made your destination selection, you can now choose from:

- **SET AS DEST:** Press for the Destination Map screen to appear. You can then decide if you would like to set the desired selection as a waypoint or final destination.
- **DELETE:** Press to delete the desired selection.
- **DELETE ALL:** Press to delete all entries.

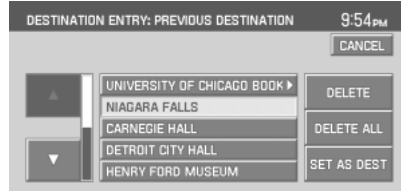

ADDRESS BOOK — DESTINATION ENTRY

The address book feature of your system allows you to view a list of address book entries previously saved. To access:

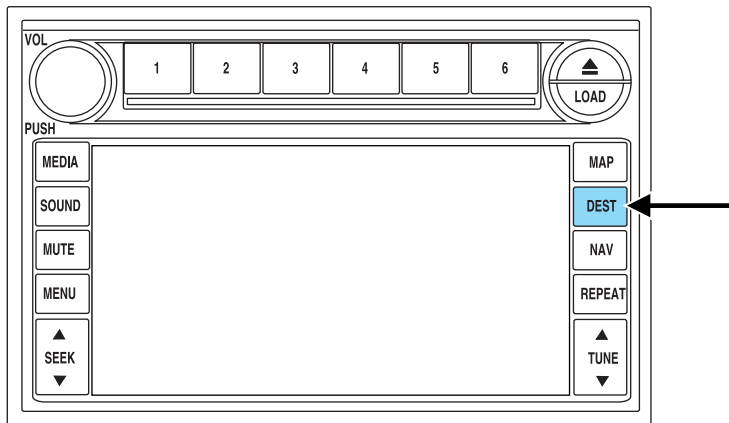

1. Press DEST.

Navigation features

2. Select ADDRESS BOOK.

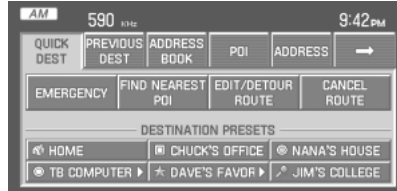

3. You may now choose to sort the list of entries by:

- **A – Z:** Select to view list in alphabetical order
- **DATE:** Select to view list in order of the entry date.
- **ICON:** Select to sort on the icon type.
- **INFO:** When the vehicle is stationary, you may select this in order to view the following information about the current address book entry:

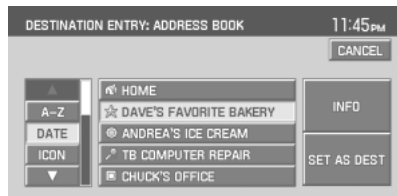

NAME

LOCATION

POINT OF INTEREST (POI) PHONE NUMBER

ICON

QUICK DEST / DESTINATION PRESET NUMBER

- **SET AS DEST:** Press to set the current address book entry as your destination. The Destination Map screen will then appear. Refer to *Destination map* for further information.

Note: If the battery is disconnected, the address book information will be saved but the previous destinations will be deleted.

To edit address book entries, press the NAV hard control and select the 'Address Book' tab. For a complete description, refer to *Address book — editing* later in this section.

Navigation features

POINT OF INTEREST (POI)

To access Points of Interest:

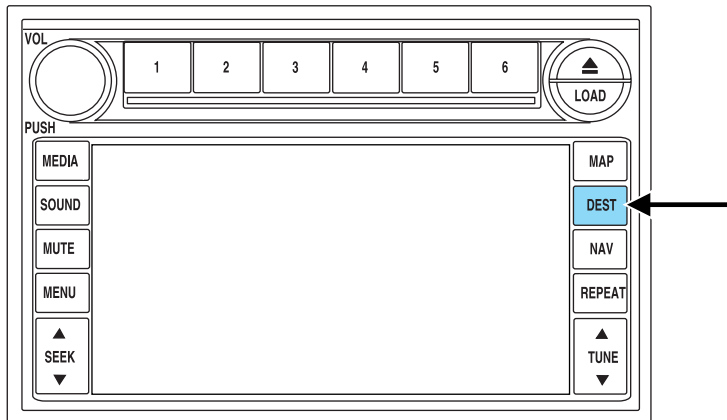

1. Press DEST.
2. Select POINT OF INTEREST (POI).

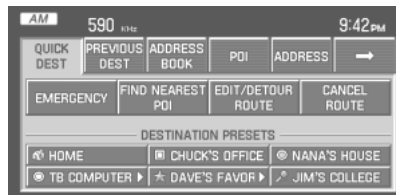

3. POI listings can be sorted alphabetically or in the order of the distance from the vehicle position. Detailed information on POIs (Name, City name, Street name, House number, Telephone number) can also be displayed.

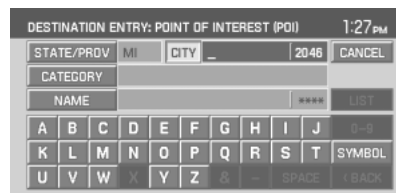

- **STATE/PROV:** Press to set the State, Province or Territory using the keyboard or select from List. The preset value for this field is based on current position (Auto Fill On) or previous selection (Auto Fill Off), depending on the settings.
- USA:** Select any state (except Alaska), including Puerto Rico and the District of Columbia.

Navigation features

CANADA: Select any province or territory.

- **CITY:** Input city name for desired location.
- **CATEGORY:** POIs can be searched by category and sub-category.
- **NAME:** When searching for a POI by name, the search can be done for a full or partial match.
- **LIST:** State/Provinces/Territories, Cities, and Names can be selected from a list determined by the Smart Speller.

ADDRESS

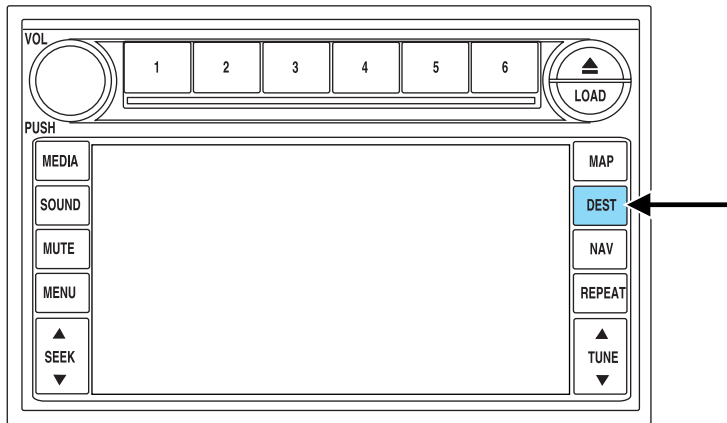

1. Press DEST.
2. Select ADDRESS.

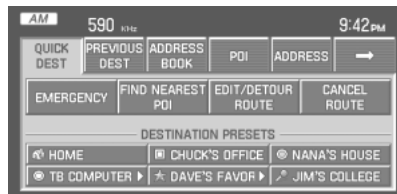

Navigation features

3. Enter the following information:

- **STATE/PROV:** Press to set the State, Province or Territory using the keyboard or select from List. The preset value for this field is based on current position (Auto Fill On) or previous selection (Auto Fill Off), depending on the settings.

DESTINATION ENTRY: ADDRESS 1:30 PM

STATE/PROV	MI	CITY	DETROIT	1	CANCEL
STREET	2440	NUMBER		LIST	

A	B	C	D	E	F	G	H	I	J	0-9
K	L	M	N	O	P	Q	R	S	T	SYMBOL
U	V	W	X	Y	Z	&	-	SPACE	BACK	

USA: Select any state (except Alaska), including Puerto Rico and the District of Columbia.

CANADA: Select any province or territory.

- **CITY:** Input city name for desired location.
- **STREET:** Streets which include numbers in their name can be searched if the name is input using digits or a spelling of the number. This applies to street names containing whole numbers from 1 (one) to 20 (twenty) or 1st (first) to 20th (twentieth) only.
- **NUMBER:** After the street has been input, the Smart Speller will allow the user to enter a house number in the range of the area specified.
- **LIST:** State/Province, City, Street can be selected from a list determined by the Smart Speller.

Navigation features

POI PHONE NUMBER

The system will allow you to search for an address book entry or POI using the phone number.

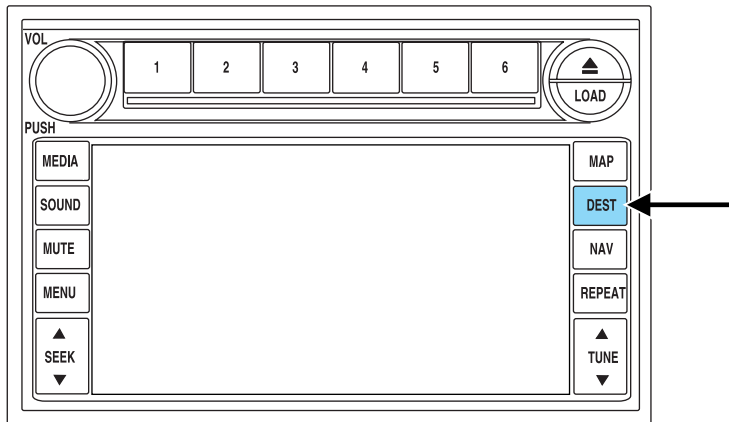

1. Press DEST.
2. Select PHONE NUMBER.



3. Use the key pad to enter the desired phone number. Press ENTER. A list of possible matches will appear. Select the correct one. You can then set that location as your destination. If the phone number matches one of the saved destinations, the destination map will appear showing the location.

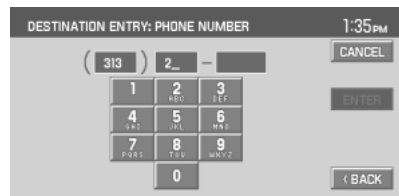

Navigation features

INTERSECTION

To set an intersection as a destination:

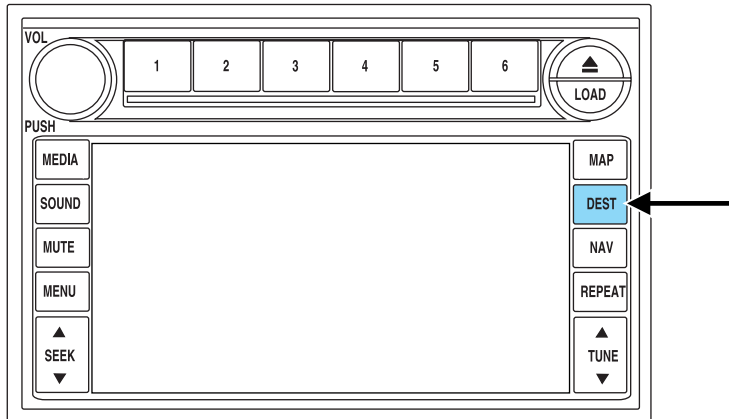

1. Press DEST.
2. Select INTERSECTION to program a destination to a major intersection.



3. Under STREET #1, use the keypad to type in the name of the first street. The streets that intersect with your STREET #1 will appear in a list. Select the desired street (STREET #2) from the list. The list can be sorted alphabetically, or in the order of distance from the current position. After entering the desired intersection, select the city from the list. The Destination Map will appear.
- **STATE/PROV:** Press to set the State, Province or Territory using the keyboard or select from List . The preset value for this field is based on current position (Auto Fill On) or previous selection (Auto Fill Off), depending on the settings.

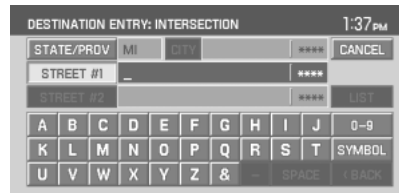

Navigation features

USA: Select any state (except Alaska), including Puerto Rico and the District of Columbia.

CANADA: Select any province or territory.

- **CITY:** Input city name for desired location.
- **STREET#1:** Streets which include numbers in their name can be searched if the name is input using digits or a spelling of the number. This applies to street names containing whole numbers from 1 (one) to 20 (twenty) or 1st (first) to 20th (twentieth) only.
- **STREET#2:** Enter a valid name for the intersecting street, or select from a list.
- **LIST:** State/Provinces/Territories, Cities, and Names can be selected from a list determined by the Smart Speller.

FREEWAY ENTRANCE/EXIT

To set a freeway entrance or exit as a destination:

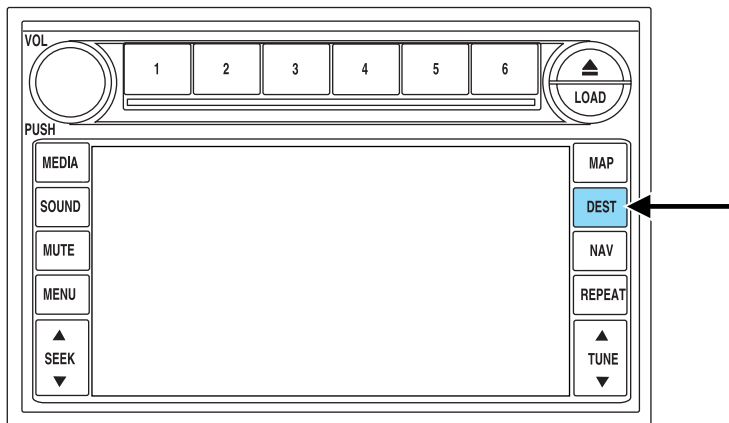

1. Press DEST.

Navigation features

2. Select FREEWAY ENTRANCE/EXIT.



The system will allow you to input of a Freeway name, and an entrance or exit to that freeway. The entrance/exit list can be sorted alphabetically or by distance from the vehicle position. After selecting the desired intersection, the Destination Map will appear.

- **STATE/PROV:** Press to set the State, Province or Territory using the keyboard or select from List. The preset value for this field is based on current position (Auto Fill On) or previous selection (Auto Fill Off), depending on the settings.

USA: Select any state (except Alaska), including Puerto Rico and the District of Colombia.

CANADA: Select any province or territory.

- **FREEWAY:** The Smart Speller will facilitate the entry of a valid freeway in the area specified.
- **LIST:** State/Provinces/Territories, Cities, and Names can be selected from a list determined by the Smart Speller.

DESTINATION MAP

After the destination type has been selected, and the necessary information is entered, the desired location will be shown on the destination map. You can then plan a route or save the location by using one of the buttons at the bottom of the screen:

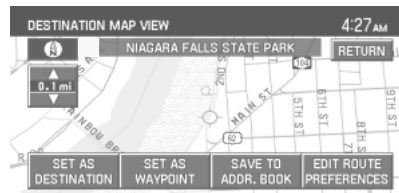

- **SET AS DESTINATION:** Select for the system to calculate your selected destination immediately. The SELECT ROUTE screen will then display. Refer to *Select route*.
- **SET AS WAYPOINT:** Select for the desired location to be stored as a waypoint. The DESTINATION/WAYPOINT LIST will then display. Refer to *Destination/Waypoint list*.

Navigation features

- **SAVE TO ADDRESS BOOK:** Select for the system to store desired location in the address book.
- **EDIT ROUTE PREFERENCES:** Select to set or change the preferences for the selected route. Refer to *Route preferences*.

DESTINATION/WAYPOINTS LIST

After you have selected a location, you can set that location as a waypoint by pressing the SET AS WAYPOINT while in the DESTINATION MAP screen. If a route is already active, press DEST and select the QUICK DEST tab, or press EDIT



DESTINATION/WAYPOINTS directly from the map. The Destination/Waypoint List screen will appear, showing a list of the final destination and up to five waypoints. From this screen, you can select:

- **OPTIMIZE:** This appears on screen when multiple waypoints have been listed. Press in order to find the first closest waypoint and then the next closest waypoint.
- **CHANGE ORDER:** This appears after one waypoint has been selected. Press to manually arrange waypoints moving them one space up or down at a time in the list. You can also move the destination to a waypoint, making the last waypoint the new destination.
- **ADD ANOTHER:** This selection allows you to search and add one more waypoint or destination to the list. This becomes disabled once there are five waypoints and one destination programmed.
- **DELETE:** Press to delete the selected waypoint from the list.
- **DELETE ALL:** Press to delete all the listed items.
- **COMPUTE ROUTE:** Press for the system to begin calculating the selected destination and waypoints.

Note: You can select waypoints before a destination is selected. If a waypoint is deleted while a route is active, the route is recalculated from the current position to the following waypoint or destination.

Navigation features

SELECT ROUTE SCREEN

The Select route screen will appear after COMPUTE ROUTE is selected from the DESTINATION/WAYPOINTS LIST screen or the SET AS DESTINATION from the DESTINATION MAP screen. You can then select from any of the following options:



- **ROUTE PREFS:** Press to change settings for route searches. Refer to *Route preferences*.
- **START ROUTE:** Press to begin guidance for the selected route. All other calculated routes will be deleted.
- **CANCEL ROUTE:** Press to delete the current route (which you will not be able to retrieve.)

The system will display all computed routes, and the preferred route will be highlighted. A route information box will appear on the right hand side of the screen which consists of:

- **ROUTE PREFERENCE ICONS:** These icons indicate the status of the route preferences. Refer to *Route preferences*.
- **CALCULATED POSSIBLE ROUTES:** These routes will be displayed simultaneously, each highlighted with a different color. To view the details of each route, press the corresponding button.

RECALCULATION OF ROUTE

If the vehicle deviates from the selected guidance route, the navigation system will automatically recalculate the route from the current location.

VOICE GUIDANCE PROMPTS

Once a route is selected, you will begin to hear voice guidance prompts. If you are not currently on the route, there will be a prompt. There may be up to three voice prompts for each maneuver, depending on the vehicle speed and the distance before the maneuver. The voice prompts will announce all road names in route guidance instructions. Road name pronunciations may vary from local pronunciations. The last prompt will be a double tone and will give just enough time for you to complete the maneuver.

To adjust the volume level of the voice guidance prompts, turn the volume control during a voice prompt, or set to the desired level on the FEEDBACK screen. (Refer to the *Menu* section).

Navigation features

NAVIGATION MENU

MAP PREFERENCES

Your navigation system allows you to set specific map preferences. In the Map Preference screen you may select from:

MAP CONTENT Select one of the following map displays:

- **CURRENT STREET NAME:** Displays the current street name in a window at the top of the screen.
- **TIME TO DESTINATION:** Displays the distance and estimated travel time to the selected destination on the left side of the screen. When selected, a popup screen will also display the Estimated Time of Arrival (ETA).
- **BREADCRUMBING:** Stores and allows the display of the vehicle's previous route(s). These routes are indicated by white dots on the map display. The system can store up to about 140 miles/230 km.

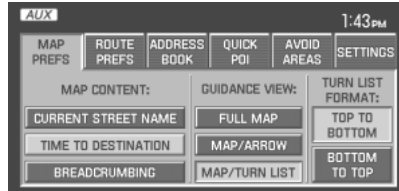

GUIDANCE VIEW: Select one of the guidance views:

- **FULL SCREEN MAP MODE:** The map is displayed on the full screen and a turn icon appears in the upper right hand corner of the screen.
- **SPLIT SCREEN ARROW MODE:** The screen is divided in two: the map is displayed on the left, while a turn icon and street name signify the upcoming maneuver on the right.

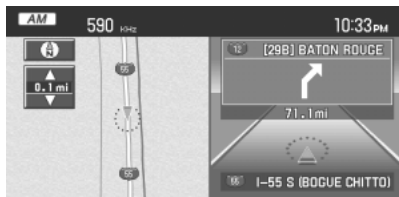
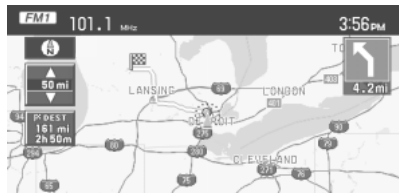

Navigation features

- **SPLIT SCREEN TURN LIST MODE:** The screen is divided in two, the map is displayed on the left, and the planned turn list is on the right.



Regardless which guidance view is selected, a detailed intersection screen will appear on the right side of the map display when the vehicle is approaching the next turn.

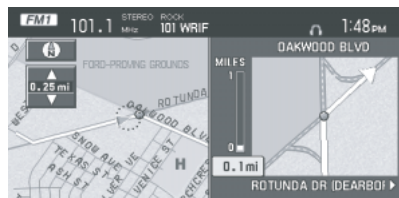

TURN LIST FORMAT: You can select which order the guidance instructions appear on the screen:

- TOP TO BOTTOM
- BOTTOM TO TOP

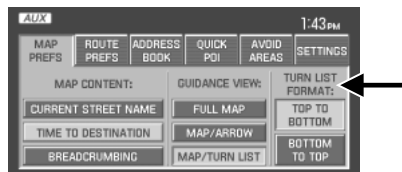

ROUTE PREFERENCES

You can select certain preferences for your route.

- **AVOID FREEWAYS / TOLL ROADS / FERRIES:** The system will search for routes attempting to avoid the use of freeways, toll roads and/or ferries whenever possible.
- **PREFERRED ROUTE:** The system can search for up to three routes: fastest route, shortest route and unrestricted route (the fastest or shortest route without any "avoid" settings). If there are not any Avoid settings, only two routes will be calculated and displayed. The preferred route will be automatically highlighted on the map for route selection.

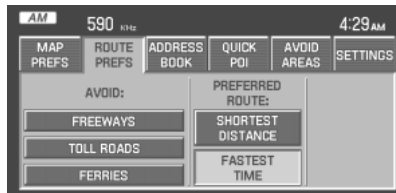

Navigation features

ADDRESS BOOK — EDITING

The ADDRESS BOOK tab allows you to view and edit the address book entries. The maximum number of entries that can be stored in the address book is 25. Five of these entries can be set as Destination Presets (to be easily accessed), and one entry can be saved as the Home location. To set an Address Book entry as a destination preset, select the address book entry and select the view/edit button.

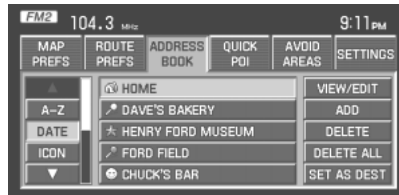

Select the set button at the bottom of the screen adjacent to Quick Dest. The list of entries can be sorted by:

- **A-Z:** List entries by alphabetical order.
- **DATE:** List entries by date of entry.
- **ICON:** List entries by icon type.

VIEW/EDIT: The information related to each entry can be changed or entered according to the following criteria:

- **NAME:** Input a name or leave this blank.
- **LOCATION:** Previously programmed address.
- **PHONE NUMBER:** Select to edit phone number for the specified entry.
- **ICON:** Select from a list of available icons. All icons, except for the Home icon, can be used more than once.
- **QUICK DEST SET/CLEAR:** A maximum of five entries can be selected as Destination Preset entries. These entries are accessible directly from the QUICK DEST tab under the DEST menu as well as through any of the ADDRESS BOOK tabs.
- **VOICE NAMETAG SET/CLEAR:** Use for voice tag designation.

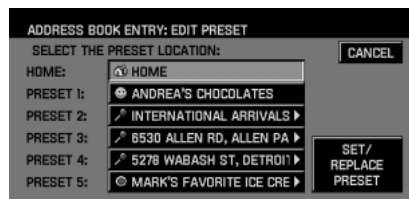
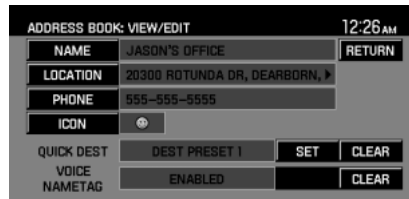

Navigation features

ADD: You can select a location by one of the following methods:

- **PREVIOUS DEST**
- **POI**
- **ADDRESS**
- **INTERSECTION**
- **MAP**
- **FREEWAY ENT/EXIT**
- **PHONE NUMBER**

DELETE: Press to delete the selected entry from the list.

DELETE ALL: Press to delete all entries in the address book.

SET AS DEST: Press for the DESTINATION MAP screen to appear with more options from which to select. Refer to *Destination menu*.

QUICK POINTS OF INTEREST (POIS)

This tab allows you to set the five most frequently used Point of Interest (POI) categories.

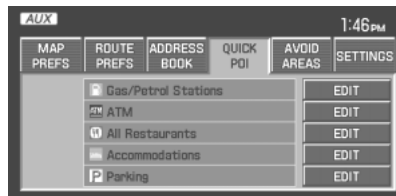

- **QUICK POI LIST:** Lists five preset POI categories. You can change any of them.
- **EDIT:** Press to select a different POI category/subcategory from a list.

AVOID AREAS

You can search avoiding all roads (even freeways) within specified avoid areas. If any road within an avoid area is used for the route, an icon will be displayed on the screen for route selection. A maximum of five areas can be stored as Avoid Areas. They are represented on the map as colored squares. If a road is specified as an avoid area, it is represented by a different color to other roads.

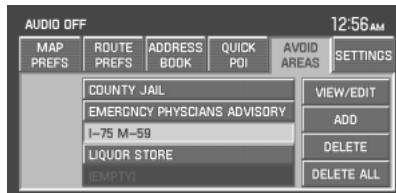

Navigation features

VIEW/EDIT: After entries are programmed, they are shown in a list. Highlight your selection to change/edit the following attributes:

- **NAME:** Select to enter a different name for the area.
- **LOCATION:** A map with the selected location will appear on the screen. You can then:

REDUCE AREA

SAVE AREA

EXPAND AREA

- **RETURN:** Saves changes to the selected area.

ADD: Add an avoid area by selecting an input method and entering the required information:

- **PREVIOUS DEST**
- **POI**
- **ADDRESS**
- **INTERSECTION**
- **MAP**
- **FREEWAY ENTRANCE/EXIT**
- **PHONE NUMBER**
- **CANCEL**

DELETE: Press to delete the selected entry.

DELETE ALL: Press to delete all entries in the Avoid Area list.

SETTINGS

UNITS: The system can be set to display different units:

- **ENGLISH (MILES)**
- **METRIC (KILOMETERS)**

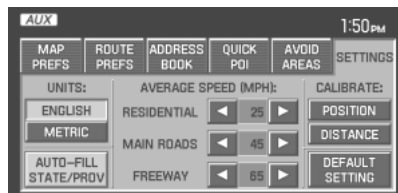

AUTO-FILL STATE/PROV: When selected, the State/Province field will be automatically filled in based on current location for destination entry. If it is not selected, the last State/Province will be displayed.

Navigation features

AVERAGE SPEED (MPH): You can preset speeds based on driving habits for calculation of travel time and ETA (Estimated Time Arrival).

- **RESIDENTIAL**
- **MAIN ROADS**
- **FREEWAY**

CALIBRATE: The navigation system supports a quick method to calibrate the vehicle position. Under normal circumstances this calibration is done automatically, but over a longer period of time. The user may want to recalibrate the system if the vehicle icon is not tracking proper position resulting in inaccurate route guidance instructions.

- **POSITION:** The system supports manual adjustment of the vehicle's position and heading via the Map. Press to scroll on map until the desired location is reached and press ENTER. Adjust the vehicle heading by pressing the arrow buttons until the desired heading is reached. Press ENTER to save the new settings.

DEFAULT SETTINGS: Press to set all the features in this screen back to system default.

VOICE RECOGNITION

Your navigation system is equipped with Voice Recognition (VR), a hands-free way of operating the radio and navigation system while driving. With this feature, you can control navigation, audio, display and voice settings by "speaking" specific commands.

Press  or VOICE on your steering wheel controls to activate Voice recognition. Speak clearly and ensure that the commands are spoken exactly as they are written or they may not function. You must say the system function followed by the sub command. System functions are listed in bold below; subcommands are listed beneath. For example, if you wanted the map to be shown on the system screen, you would say "Navigation Show Map".

If the voice system is already engaged in a specific function, there is no need to continue repeating that function for future commands within a 30 second period. For example, if you just finished saying "Navigation Show Map" and then wanted to zoom the map in, you could say "Zoom In" instead of "Navigation Zoom In". After 30 seconds has elapsed, the voice system will start the next voice session from the main menu.

Navigation features

Navigation+	Audio+	Display +	Voice Settings +	Tutorial +
	Line In			
	Rear Aux			
	Radio +			
Detour / Reroute	Play	ON	Interaction Mode	Lesson 1
Cancel Route	Auto Preset	OFF	Interaction Mode Standard	Lesson 2
Cancel Next Waypoint	Seek Up	Night	Interaction Mode Advanced	Lesson 3
Repeat Instruction	Seek Down	Day	Profile Create	Previous Lesson
Voice On	Tune Frequency	Auto	Profile Delete (Profile Name)	Next Lesson
Voice Off	Tune AM	Brighter	Profile Select (Profile Name)	
Voice Louder	Tune FM	Dimmer	Profile Select None	
Voice Softer	Tune FM1	Help	Help	
Help	Tune FM2			
<i>Map Commands</i>	Tune Preset #			
Show Map	Store Preset #			
Zoom In				
Zoom Out	Help			
Zoom In Minimum	CD +			

Navigation features

Navigation+	Audio+	Display +	Voice Settings +	Tutorial +
Zoom In Maximum	Play			
Show Destination	Play Disc #			
Show or Clear Next Waypoint	Play Track #			
Show or Clear Route	Play Folder #			
Show North Up	Play Disc # Folder # Track #			
Show Heading Up	Play Next Disc			
<i>Destination Commands</i>	Play Next Folder			
Route Home/Return Home	Play Next Track			
Destination (Nametag)	Play Previous Disc			
Play Nametags	Play Previous Folder			
Destination or Find a Restaurant	Play Previous Track			
Destination or Find all Restaurants	Folder Mode			
Destination or Find an American Restaurant	Folder Mode On			

Navigation features

Navigation+	Audio+	Display +	Voice Settings +	Tutorial +
Destination or Find an Chinese Restaurant	Folder Mode Off			
Destination or Find a Fast food Restaurant	Shuffle, Random or Mix			
Destination or Find an Italian Restaurant	Shuffle, Random or Mix On			
Destination or Find a Mexican Restaurant	Shuffle, Random or Mix Off			
Destination or Find a Seafood Restaurant	Help			
Destination or Find a Steak House Restaurant	DVD+			
Destination or Find a Vegetarian Restaurant	Play			
I'm Hungry	Play Next or Previous Chapter			
Destination or Find an Auto Parts	Play Next or Previous Chapter			

Navigation features

Navigation+	Audio+	Display +	Voice Settings +	Tutorial +
Destination or Find an/a automobile / car dealership	Play Next or Previous Folder			
Destination or Find a Ford dealership	Play AUX			
Destination or Find a Lincoln dealership	Play Previous Folder			
Destination or Find a Mercury dealership	Headphones ON			
Destination or Find an oil change	Headphones OFF			
Destination or Find a Business Facility	Shuffle Tracks			
Destination or Find a Community Center	Shuffle ON			
Destination or Find Education	Shuffle OFF			
Destination or Find Higher Education/ College/ University	Folder Mode ON			

Navigation features

Navigation+	Audio+	Display +	Voice Settings +	Tutorial +
Destination or Find K-12 Schools	Folder Mode OFF			
Destination or Find an Exhibition/ Conference Center	Help			
Destination or Find a Library	*Satellite Radio +			
Destination or Find a Named Place	Play			
Destination or Find a Hospital	Seek up			
Destination Police, Find a Police Station or Find Police	Seek Down			
Destination or Find an Amusement Theme Park	Tune (#)			
Destination or Find a Casino	Tune SR1			
Destination or Find a Movie Theater	Tune SR2			
Destination or Find a Museum	Turn SR3			

Navigation features

Navigation+	Audio+	Display +	Voice Settings +	Tutorial +
Destination or Find a Performing Arts	Preset #			
Destination or Find a Zoo/Botanical Gardens	Store Preset #			
Destination or Find an ATM	Next Channel			
Destination Bank/Banking or Find a Bank	Previous Channel			
Destination or Find a Historical Monument				
Destination or Find an International Border Crossing				
Destination or Find Parking				
Destination or Find Public Transit				
Destination or Find an Airport				

Navigation features

Navigation+	Audio+	Display +	Voice Settings +	Tutorial +
Destination or Find a Bus Station				
Destination or Find a Commuter Rail				
Destination or Find a Ferry Terminal				
Destination or Find a Rest Area				
Destination or Find a Tourist Attraction				
Destination or Find Tourist Information				
Destination or Find Coffee House, Find Cafe				
Destination or Find Pharmacies				
Destination or Find a Book Store				

Note: Satellite Radio and DVD voice commands are operational only on vehicles equipped with those features.

Navigation features

A listing of all available voice commands also resides in the navigation system. To access this list:

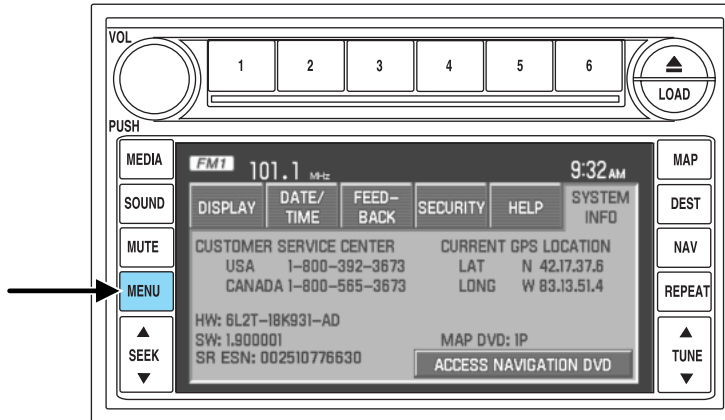

1. Press the MENU hard key.
2. Press SYSTEM INFO.
3. Press HELP.
4. Select VOICE SETTING COMMANDS.

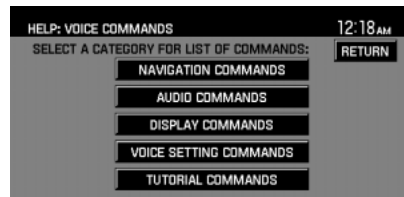

Voice recognition (VR) operates for all system languages. There is a push to talk button on the vehicle steering wheel labeled either VOICE or . Press to activate Voice Recognition. The system will state available commands, and then listen for a spoken response from you. Speak the command clearly to ensure that the system is able to recognize and perform the desired function.

Navigation features

VOICE RECOGNITION VISUAL FEEDBACK (NAVIGATION STATUS BAR)



When Voice recognition (VR) is activated, the following icons will appear on the screen in the status bar.





VR State	VR Icon	VR Device Text
Main Menu		Main Menu
Audio system		Audio System
Navigation		Navigation
MP3		MP3
Satellite Radio		Satellite Radio
FM Radio		FM
AM Radio		AM
CD		CD
Voice Preferences		Voice Settings
Display		Display
Tutorial		Tutorial
DVD		DVD
DVD_MP3		DVD_MP3
DVD_CD		DVD_CD
VR Recognition Failure		Listening Failed
VR Session Successful Completion		Voice Success
VR Session Unsuccessful Termination		Voice Failed
Listening		Listening

Navigation features

For the best system performance, please adhere to the following:

- The interior of the vehicle needs to be as quiet as possible. Wind noise from open windows, road vibrations, and radio volume may prevent the system from correctly recognizing voice commands.
- Wait until the tone sounds after pressing the push to talk button before speaking a command.
- Speak naturally without large pauses in between words.
- Please realize voice recognition performance is not 100% and varies by user. The voice recognition system is meant to be a secondary convenience control and if it doesn't operate optimally, users can still operate their navigation system via the touch screen and hard buttons.

To speak voice commands:

1. Push the talk button on the steering wheel. A tone will sound.
2. 'Main Menu' and  will appear in the status bar.
3. The system will speak the available voice commands and a tone will sound.
4. 'Listening' and  will appear in the status bar and the system waits for your response.
5. If the system is not confident that it recognized the user's voice command, it will ask for a confirmation of yes or no.
6. If the system does not recognize or hear the user's voice command, it will say, 'Sorry, please say' and repeat the available voice commands. The voice failed icon  will be displayed in the status bar.
7. If the system does not recognize or hear the user's voice command a second time, the system will say, 'Sorry, please press the voice button and try again' and the voice session is terminated.
8. Once confirmation / recognition takes place, the voice success icon  is displayed, the system will speak the next level of available commands, a tone will sound, and the appropriate voice menu name and icon will be displayed.
9. If the voice session is not complete, the system will then speak the next set of available voice commands, a tone will sound, and the system will display 'listening'  and again, waits for a response.
10. This sequence of events occurs until the voice recognition session is complete.

Navigation features

Three voice recognition tutorials are available through the voice system:

- Lesson One: What you can do with speech
- Lesson Two: How we'll work together
- Lesson Three: Getting accustomed to the system

To access the tutorials, press the voice button on the steering wheel and say, 'Tutorial Lesson (1, 2 or 3).'

Voice settings

Voice settings are adjusted through the voice recognition. In voice settings, you can customize the system to behave the way you prefer as well as train the system to fine tune its listening to a specific user by creating a profile. The following settings are available:

- Interaction mode: standard or advanced

Standard system provides detailed user instructions and announces all available voice commands

Advanced system speaks less and assumes that the user knows the voice commands

- Profile: trains the system to create voice profiles of users. The vehicle must be in Park and the profile takes approximately 10 minutes to complete.

Voice Tags

Voice recognition includes a function that allows you to input personal names for locations to be recognized by the system. These are called 'voice name tags'. You can assign voice name tags to all locations stored in the address book to be used later as destinations.

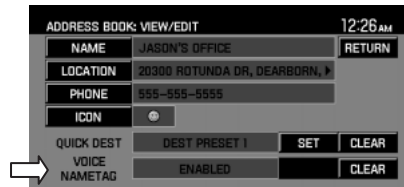

Frequently asked questions

FREQUENTLY ASKED QUESTIONS

How do I turn off the Navigation System?

Press and hold the Volume control for at least 3 seconds.

How do I hear the navigation voice prompts?

1. Press the MENU hard button.
2. Select the FEEDBACK tab.
3. Check the VOICE VOLUME LEVEL and that the NAVIGATION GUIDANCE setting is on.

How do I recover after accidental language re-set?

1. Press the MENU hard button.
2. Select the FEEDBACK/Retour/Reaccion tab.
3. Press the ENGLISH/Anglais/Ingles button to reset language to English.
4. Press the SPANISH/Espanol/Espanol button to reset language to Spanish.
5. Press the FRENCH/Francais/Frances button to reset language to French.

Or, you can also turn vehicle off to restart system. Then from the DISCLAIMER screen, select the desired language before pressing AGREE.

Frequently asked questions

TROUBLESHOOTING

Symptoms	Possible Cause	Action
Focus Error	System unable to play reproduced disc.	Contact your dealer.
Bad Disc	Disc was inserted upside down or the system is unable to read the information in the disc.	The mechanism will automatically eject disc.
Track Error	The system is unable to reproduce a corrupt MP3 file.	The system will skip the corrupted track.
Invalid Disc Detected	Dirty DVD	Wipe the DVD with a dry, soft cloth from the center to the outer edge of the disc.
System has detected incompatible NAV DVD Would you like to change a NEW DVD? (Popup window)	The DVD mechanism is unable to reproduce the information in the disc inserted in the DVD slot.	Eject the currently loaded disc, and insert the correct map DVD in the DVD slot. Refer to <i>Loading and Ejecting Navigation Map DVDs</i> in the System Features section.
Address not found/ Address range does not exist. Show the midpoint of the street? (Popup window)	The house number entered is not registered in the database.	Press NO and enter a valid number for the specified street, or press YES to view the middle point of the street.

Frequently asked questions

Symptoms	Possible Cause	Action
Navigation Fault. A system fault has been detected that may cause the navigation to perform abnormally. Please contact your dealership. (Popup window)	System hardware or software error	Contact your dealer.
Error. PINs did not match. Please re-enter. (Popup window)	A different PIN was entered to unlock the system for valet mode.	Press OK and try entering PIN again. If unable, contact your dealer.
Invalid PIN. Please Re-enter. (Popup window)	System does not recognize PIN as valid.	Press OK and enter different PIN to lock the system.
Error. Map DVD must be loaded in order to change language. (Popup window)	Map DVD is not in DVD slot.	Press OK, then load a valid map DVD.
Navigation DVD error. Installation failed. Please install a valid Navigation DVD. (Popup window)	The DVD mechanism is unable to reproduce the information in the disc inserted in the DVD slot.	Eject the currently loaded disc, and insert the correct map DVD in the DVD slot. Refer to <i>Loading and Ejecting Navigation Map DVDs</i> in the System Features section.

General Information

SYSTEM HELP

Please refer to the system Help Menu or system functional descriptions. If additional help is required, please contact Ford Customer Service in the US at 1 (800) 392-3673 and in Canada 1 (800) 565-3673.

MAP DATA DVD END-USER LICENSE TERMS

The data ("Data") is provided for your personal, internal use only and not for resale. It is protected by copyright, and is subject to the following terms and conditions which are agreed to by you, on the one hand, and (Licensee). ("Licensee") and its licensors (including their licensors and suppliers) on the other hand. Such licensors include NAVTEQ North America, LLC. Without limiting the foregoing, you agree that NAVTEQ North America, LLC shall have the right to enforce these Terms directly against you. © 2004 NAVTEQ. All rights reserved. The Data for areas of Canada includes information taken with permission from Canadian authorities, including: © Her Majesty the Queen in Right of Canada, © Queen's Printer for Ontario, © Canada Post Corporation, Geobase ®.

TERMS AND CONDITIONS

Personal use only: You agree to use this Data together with your FLM navigation system for solely personal, non commercial purposes for which you were licensed, and not for service bureau, time-sharing or other similar purposes. Accordingly, but subject to the restrictions set forth in the following paragraphs, you may copy this Data only as necessary for your personal use to (i) view it, and (ii) save it, provided that you do not remove any copyright notices that appear and do not modify the Data in any way. You agree not to otherwise reproduce copy, modify, decompile, disassemble or reverse engineer any portion of this Data, and may not transfer or distribute it in any form, for any purpose, except to the extent permitted by mandatory laws.

Restrictions: Except where you have been specifically licensed to do so by (Licensee), and without limiting the preceding paragraph, you may not (a) use this Data with any products, systems, or applications installed or otherwise connected to or in communication with vehicles, capable of vehicle navigation, positioning, dispatch, real time route guidance, fleet management or similar applications; or (b) with or in communication with any positioning devices or any mobile or wireless-connected electronic or computer devices, including without limitation cellular phones, palmtop and handheld computers, pagers, and personal digital assistants or PDAs.

General Information

No warranty: This Data is provided to you “as is,” and you agree to use it at your own risk. (Licensee) and its licensors (and their licensors and suppliers) make no guarantees, representations or warranties of any kind, express or implied, arising by law or otherwise, including but not limited to, content, quality, accuracy, completeness, effectiveness, reliability, fitness for a particular purpose, usefulness, use or results to be obtained from this Data, or that the Data or server will be uninterrupted or error-free.

Disclaimer of warranty: (Licensee) and its licensors (including their licensors and suppliers) disclaim any warranties, express or implied, of quality, performance, merchantability, fitness for a particular purpose or non infringement. Some States, Territories and Countries do not allow certain warranty exclusions, so to that extent the above exclusion may not apply to you.

Disclaimer of liability: (Licensee) and its licensors (including their licensors and suppliers) shall not be liable to you: in respect of any claim, demand or action, irrespective of the nature of the cause of the claim, demand or action alleging any loss, injury or damages, direct or indirect, which may result from the use or possession of the information; or for any loss of profit, revenue, contracts or savings, or any other direct, indirect, incidental, special or consequential damages arising out of your use of or inability to use this information, any defect in the information, or the breach of these terms or conditions, whether in an action in contract or tort or based on a warranty, even if (Licensee) or its licensors have been advised of the possibility of such damages. Some States, Territories and Countries do not allow certain liability exclusions or damages limitations, so to that extent the above may not apply to you.

Export control: You agree not to export from anywhere any part of the Data provided to you or any direct product thereof except in compliance with, and with all licenses and approvals required under, applicable export laws, rules and regulations.

Termination for Breach or Bankruptcy: (Licensee) and its licensors, including NAVTEQ, may terminate this Agreement if you breach any of its terms. Upon any such termination, you shall immediately cease your use of the Data and return all copies thereof to LICENSEE or NAVTEQ, as instructed. (Licensee) and its licensors also may terminate this Agreement in the event that you (i) fail to pay license fees due for the Data, or (ii) if any of the following events occur affecting you: (a) voluntary bankruptcy or application for bankruptcy; (b) involuntary bankruptcy or application for bankruptcy not discharged within sixty (60) days; (c) appointment of receiver for all or a portion of your assets; or (d) any assignment for the benefit of creditors.

General Information

Entire agreement: These terms and conditions constitute the entire agreement between (Licensee) (and its licensors, including their licensors and suppliers) and you pertaining to the subject matter hereof, and supersedes in their entirety any and all written or oral agreements previously existing between us with respect to such subject matter.

Governing law: The above terms and conditions shall be governed by the laws of the Illinois, without giving effect to (i) its conflict of laws provisions, or (ii) the United Nations Convention for Contracts for the International Sale of Goods, which is explicitly excluded. You agree to submit to the jurisdiction of Illinois for any and all disputes, claims and actions arising from or in connection with the Data provided to you hereunder.

FCC COMPLIANCE

Changes or modifications not approved by Ford Lincoln Mercury could void user's authority to operate the equipment. This equipment has been tested and found to comply with the limits with the Class B digital device, pursuant to Part 15 of the FCC Rules. These limits are designed to provide reasonable protection against harmful interference in a residential installation. This equipment generates, uses and can radiate radio frequency energy and, if not installed and used in accordance with the instructions, may cause harmful interference to radio communications.

However, there is no guarantee that interference will not occur in a particular installation. If this equipment does cause harmful interference to radio or television reception, which can be determined by turning the equipment off and on, the user is encouraged to consult the dealer or an experienced radio/TV technician for help.

PRINCIPLES OF NAVIGATION

The system directs the user based on information derived from global positioning satellites, road maps stored on the DVD, sensors in the vehicle and the desired destination. The system compiles all necessary information to guide the user to the selected destination. Space satellites broadcast information used to determine the vehicle's current location.

General Information

LIMITED GPS RECEPTION

System performance may be adversely affected if GPS reception is interrupted or interference occurs over a distance of several miles. The following are possible causes for GPS reception being interrupted. If the vehicle is:

- In multi-story parking garages
- In tunnels and under bridges
- Inside or in between buildings
- By forests or tree-lined avenues
- In heavy rain showers and thunderstorms
- In valleys and in mountainous regions
- Roads under cliffs

Ensure that you do not have any metal objects on the dashboard and that if your windows are tinted, they use non-metal tinting instead of metal oxide tinting. Both of these factors can also interrupt GPS reception.

If the vehicle has been parked for a long period of time, the navigation function may be temporarily unresponsive. The navigation system will operate reliably again once GPS reception is available for a few minutes.

SYSTEM LIMITATIONS

Cold temperature start: When operating the system below 32° F (0°C), the display screen requires a 2–3 minutes warm-up time to achieve maximum brightness.

Other conditions: When calculating a route, the system doesn't take into consideration any of the following conditions:

- Traffic Conditions
- Weather Conditions
- Driving Habits
- Construction Zones
- New Roads

General Information

GLOSSARY

COMP: Compression

DEST: Destination

DSP: Digital Signal Processing

ETA : Estimated Time of Arrival

FCC: Federal Communications Commission

GPS: Global Positioning System

MAP/NAVIGATION DVD: The disc containing a map database to operate the navigation system.

POI: Point(s) Of Interest

PROV: Province

PTY: Program Type

RDS: Radio Data System

SCV: Speed Compensated Volume

SMART SPELLER: Feature that provides a number of available candidates matching partial input entered by the user.

SR: Satellite Radio

TOUCH SCREEN: A touch-sensitive screen that lets the user make choices by touching icons or graphical buttons on the screen.

WAYPOINT: An intermediate stop or destination before the final destination.

Index

A

- Address Book - destination entry46
- Address Book - editing59
- AM/FM13
- Auxiliary input jack (Line in)22
- Avoid areas60

C

- CD20
- Cleaning Map DVDs37

D

- Date/time settings29
- Destination entry43
- Destination map54
- Destination way points55
- Displays28
- DVD (if equipped)22

F

- Freeway entrance/exit53

G

- GPS reception80

H

- Help33
- How to get going4

I

- Intersection52

82

L

- Latest map DVDs36

M

- MAP DVD - Loading and Unloading35
- Map icons41
- Map preferences57

O

- Ordering additional map DVDs37

P

- Point of Interest (POI)48
- Previous destination45

Q

- Quick destination43
- Quick POIs60
- Quick touch buttons40

S

- Satellite Radio (if equipped)15
- Security32
- Select route56
- Settings61
- Sound features24
- Speed compensated volume26
- System information34
- System introduction3
- System limitations80

Index

System overview	9	V	
T			
Troubleshooting	75	Voice recognition	62

