

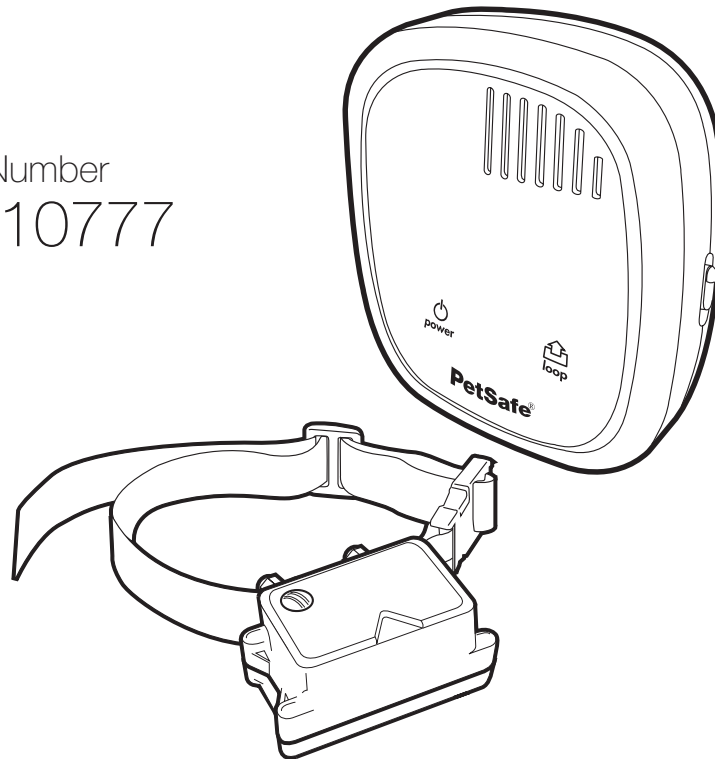

protect. **teach.** love.

Model Number
PIG00-10777



stubborn dog in-ground fence™

operating and training guide

PLEASE READ THIS ENTIRE GUIDE BEFORE BEGINNING

Important Safety Information

Explanation of Attention Words and Symbols used in this guide



This is the safety alert symbol. It is used to alert you to potential personal injury hazards. Obey all safety messages that follow this symbol to avoid possible injury or death.

⚠ WARNING

WARNING indicates a hazardous situation which, if not avoided, could result in death or serious injury.

⚠ CAUTION

CAUTION, used with the safety alert symbol, indicates a hazardous situation which, if not avoided, could result in minor or moderate injury.

CAUTION

CAUTION, used without the safety alert symbol, indicates a hazardous situation which, if not avoided, could result in harm to your pet.

NOTICE

NOTICE is used to address safe use practices not related to personal injury.

⚠ WARNING

- Not for use with aggressive dogs. Do not use this product if your dog is prone to aggressive behavior. Aggressive dogs can cause severe injury or death to their owners and others. If you are not sure that this product is right for your dog, please talk to your veterinarian or a certified trainer.
- Underground cables can carry high voltage. Have all underground cables marked before you dig to bury your wire. In most areas this is a free service. Avoid these cables when you dig.
- Follow all safety instructions for your power tools. Be sure to always wear your safety goggles.
- Do not install, connect, or remove your system during a lightning storm. If the storm is close enough for you to hear thunder, it is close enough to create hazardous surges.
- Risk of electric shock. Use the Fence Transmitter indoors in dry location only.

⚠ CAUTION

- Risk of injury. Wire on top of the ground may be a trip hazard; Use care in how you place your wires.

CAUTION

This PetSafe® Stubborn Dog In-Ground Fence™ is not a solid barrier. This system is designed to act as a deterrent to remind pets by Static Correction to remain in the boundary established. It is important that you reinforce training with your pet on a regular basis. Proper fit of the collar is important. A collar worn for too long or made too tight on the pet's neck may cause skin damage. Ranging from redness to pressure ulcers; this condition is commonly known as bed sores.

- Avoid leaving the collar on the dog for more than 12 hours per day.
- When possible reposition the collar on the pet's neck every 1 to 2 hours.
- Check the fit to prevent excessive pressure; follow the instructions in this manual.
- Never connect a lead to the electronic collar; it will cause excessive pressure on the contacts.
- When using a separate collar for a lead, don't put pressure on the electronic collar.
- Wash the dog's neck area and the contacts of the collar weekly with a damp cloth.
- Examine the contact area daily for signs of a rash or a sore.
- If a rash or sore is found, discontinue use of the collar until the skin has healed.
- If the condition persists beyond 48 hours, see your veterinarian.
- For additional information on bed sores and pressure necrosis, please visit our website.

These steps will help keep your pet safe and comfortable. Millions of pets are comfortable while they wear stainless steel contacts. Some pets are sensitive to contact pressure. You may find after some time that your pet is very tolerant of the collar. If so, you may relax some of these precautions. It is important to continue daily checks of the contact area. If redness or sores are found, discontinue use until the skin has fully healed.

You may need to trim the hair in the area of the Contact Points. Never shave the dog's neck; this may lead to a rash or infection.

- The Receiver Collar should not be on your dog when the system is tested. Your pet may receive an unintended correction.
- The Boundary Width of the system must be tested whenever an adjustment is made to the containment field to prevent unintended corrections to your pet.
- If you use a collar and leash for training, be sure the extra collar does not put pressure on the contact points.
- Always remove your dog's Receiver Collar before performing any Transmitter testing.
- If possible, DO NOT use an AC circuit protected with a Ground Fault Circuit Interrupter (GFCI) or Residual Current Device (RCD). In rare cases, nearby lightning strikes may cause the GFCI or RCD to trip. Without power your dog may be vulnerable to escape. You will have to reset the GFCI or RCD to restore power to the system.

NOTICE

- Use care when mowing or trimming your grass not to cut the loop wire.
- For added protection, when unused for long periods of time or prior to thunderstorms, unplug from the wall outlet and disconnect the loop boundary wires. This will prevent damage to the transmitter due to surges.
- To prevent an unintended correction, after the Boundary Flags have been placed, be sure to set the static correction on the receiver collar back to level 1 tone only.

Thank you for choosing PetSafe® brand. You and your pet deserve a companionship that includes memorable moments and a shared understanding together. Our products and training tools promote a lifestyle of protection, teaching, and love — essentials that influence memories for a lifetime. If you have any questions about our products or training your pet, please visit our website at www.petsafe.net or contact our Customer Care Center at 1-800-732-2677.

To get the most protection out of your warranty, please register your product within 30 days at www.petsafe.net. By registering and keeping your receipt, you will enjoy the product's full warranty and should you ever need to call the Customer Care Center, we will be able to help you faster. Most importantly, PetSafe® will never give or sell your valuable information to anyone. Complete warranty information is available online at www.petsafe.net.

Table of Contents

Components.....	5
Other Items You May Need	5
How the System Works	6
Key Definitions	6
Operating Guide	7
Locate the Fence Transmitter	7
Lay Out the System	8
Sample Layouts.....	8
Position the Boundary Wire.....	10
Connect the Wires to the Fence Transmitter	11
Prepare the Receiver Collar.....	12
Set the Boundary Width and Test the Receiver Collar	13
Install the Boundary Wire	15
Place the Boundary Flags	16
Fit the Receiver Collar	17
Training Guide	18
Be Patient With Your Pet	18
Day 1 - Boundary Awareness.....	19
Days 2 thru 4 - Continue Boundary Awareness.....	19
Days 5 thru 8 - Distraction Phase	20
Days 9 thru 14 - Unleashed Supervision.....	21
Days 15 thru 30 - Pet Monitoring.....	21
Taking Your Pet Out of the Pet Area	21
Accessories.....	22
Troubleshooting	22
Additional Information	23
System Test	24
Transmitter Loop Test.....	25
Wire Break Location Test.....	25
Terms of Use and Limitation of Liability	26
Compliance	27
Customer Care International.....	27
Mounting Template.....	28
Layout Grid.....	28

Components

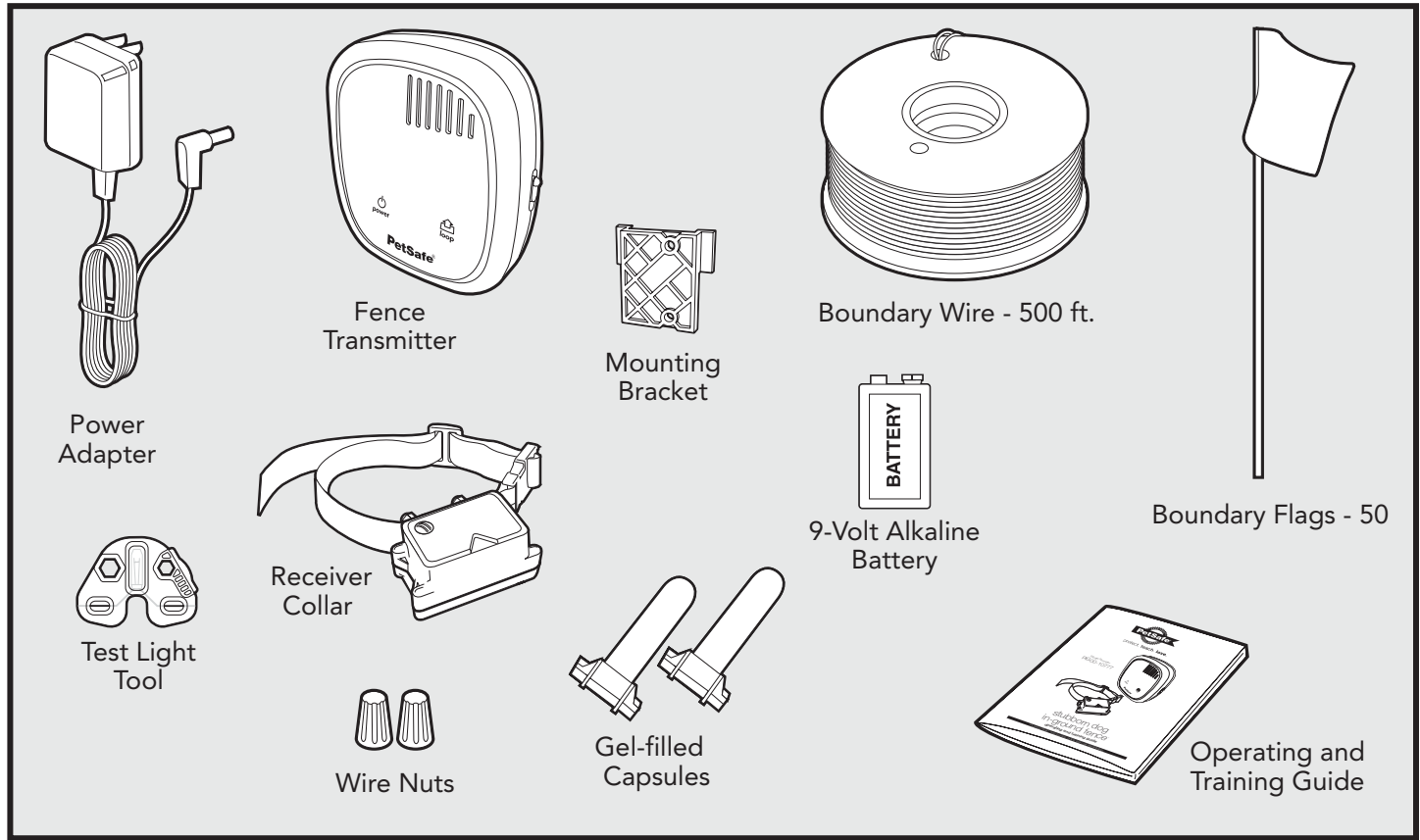

Other Items You May Need

- Additional wire and flags (Part #PRFA-500)
- Tape measure
- Small Phillips screwdriver
- Drill & mounting hardware
- Shovel or lawn edger
- Pliers
- Wire stripping pliers
- Scissors
- Lighter
- Electrical tape
- Gel-filled Capsules
- Additional wire nuts
- Waterproofing compound (e.g. silicone caulk)
- PVC pipe or water hose
- Circular saw with masonry blade
- Staple gun
- Non-metallic collar and leash

Fence installation and training help: www.petsafe.net

How the System Works

A radio signal travels from the Fence Transmitter through a buried wire, marking the boundaries you wish to set for your dog. Your dog wears a Receiver Collar that detects the signal at the boundary. As your dog approaches the boundary, the receiver issues a warning tone and vibrates. If he proceeds further, he receives a safe but startling Static Correction. While harmless, the correction will persuade him to stay in the containment area you've established. Boundary flags are a temporary visual aid for your pet; remove them after training. This PetSafe® Stubborn Dog In-Ground Fence™ has been proven safe, comfortable, and effective for pets over 8 pounds.

Key Definitions

Fence Transmitter: Transmits the radio signal through the Boundary Wire.

Pet Area: Area within the Warning Zone where your pet can roam freely.

Warning Zone: Outer edge of the Pet Area where your pet's Receiver Collar begins to beep and vibrates for

2 seconds, warning him not to go into the Static Correction Zone.

Static Correction Zone: Zone beyond the Warning Zone where your pet's Receiver Collar will emit a Static Correction, signaling him to return to the Pet Area.

Boundary Width: Combination of the Warning Zone and the Static Correction Zone.

Receiver Collar: Receives the radio signal from the Boundary Wire.

Correction Level Button: Adjusts the level of Static Correction your pet receives in the Static Correction Zone.

Receiver Indicator Light: Indicates the level of correction at which the Receiver Collar is set. This light also serves as a low battery indicator.

Contact Points: Delivers the safe Static Correction when your pet moves into the Static Correction Zone.

Power Jack: Where the Power Adapter plugs into the Fence Transmitter.

Boundary Control Switch: Switch located on the Fence Transmitter to adjust according to the length of Boundary Wire used.

Boundary Wire Terminals: Where the Boundary Wires connect to the Fence Transmitter in order to complete a continuous loop.

Loop Indicator Light: Indicates that the Boundary Wire makes a complete loop, enabling the signal to be transmitted.

Boundary Width Control: Adjusts the width of the Warning and Static Correction Zones. *Note: Adjusting the knob does not change the level of Static Correction on the Receiver Collar.*

Want professional installation help? Invisible Fence® Brand installers will come to your home and install your new PetSafe® System for an additional cost. Contact your local dealer at 1-877-866-DOGS (3647) or visit our website at www.invisiblefence.com for more information.

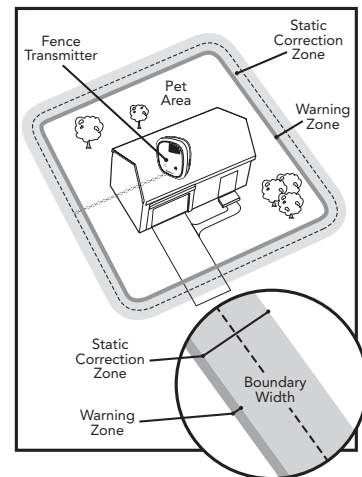

Receiver Collar

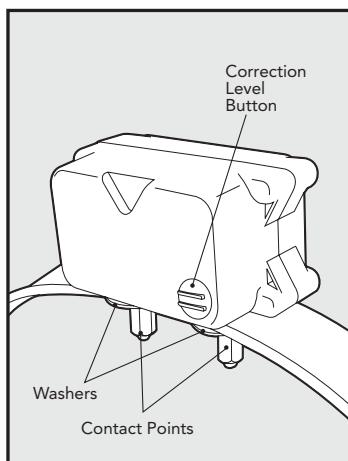

Fence Transmitter

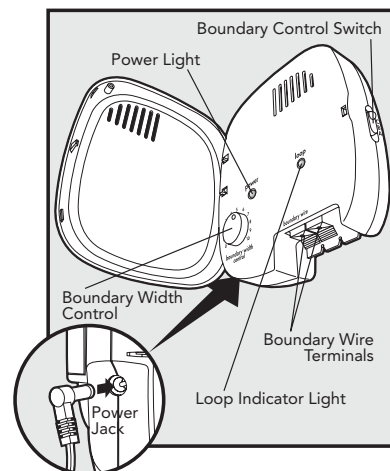

Operating Guide

Step 1 Locate the Fence Transmitter

Place the Fence Transmitter:

- In a dry, well ventilated, protected area (**1A**, **1B**).
- In an area where temperatures do not fall below freezing (e.g., garage, basement, shed, closet).
- Secured to a stationary surface using the mounting hardware. A mounting template is included in the back of this guide.
- At least 3 feet from large metal objects or appliances as these items may interfere with the signal consistency (**1C**).

To mount the Fence Transmitter, screw the mounting bracket onto a stationary surface such as a wall, and slide the Fence Transmitter onto the bracket. Once you have mounted the Fence Transmitter, the Boundary Wire must exit the building. This can be accomplished via a window or through a hole drilled through the wall. Ensure the drill path is clear of any utilities. Make sure the Boundary Wire is not cut off or pinched by a window, door, or garage door, as this can damage it over time.

To prevent fires and electrical hazards, install the Fence Transmitter in buildings that are in accordance with state and local electrical codes.

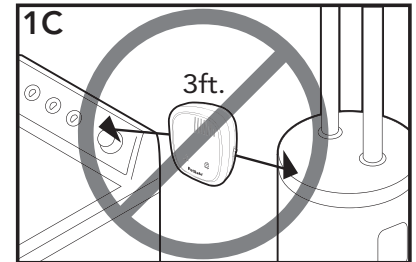
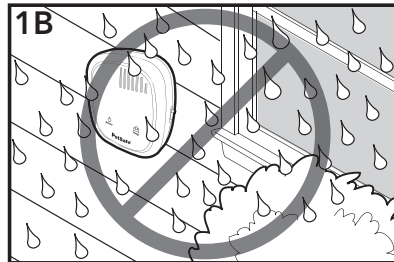
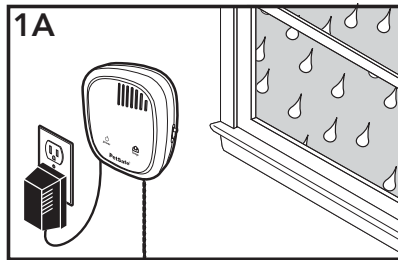

Step Lay Out the System

2

Basic Planning Tips

⚠ WARNING Underground cables can carry high voltage. Have all underground cables marked before you dig to bury your wire. In most areas this is a free service. Avoid these cables when you dig.

For information regarding how these underground wires can affect your system's operation, see Step 3 Position the Boundary Wire.

- The Boundary Wire **MUST** start at the Fence Transmitter and make a continuous loop back (2A).
- Twisting the Boundary Wire cancels the signal and allows your pet to cross over that area without correction. Plastic or metal piping will not cancel the signal. Twist the Boundary Wire 10 to 12 times per foot to cancel the signal (2A).
- Design a layout that is suitable for your yard. Sample layouts are provided in this section, and a grid for designing your layout is provided in the back of this guide.
- Always use gradual turns at the corners with a minimum of 3 foot radius to produce a more consistent boundary (2B). Do not use sharp turns, as this will cause gaps in your boundary.
- To properly contain your pet, we recommend setting a Boundary Width for the Warning and Static Correction Zones to approximately 12-20 feet (6 to 10 feet on each side of the wire).
- Avoid making passageways too narrow for your pet to move about freely (e.g., along the sides of a house).
- The Receiver Collar can be activated inside the house if the Boundary Wire runs along the outside wall of the house. If this occurs, remove your pet's Receiver Collar before bringing him inside, decrease the range using the Boundary Width Control knob or consider an alternate layout.

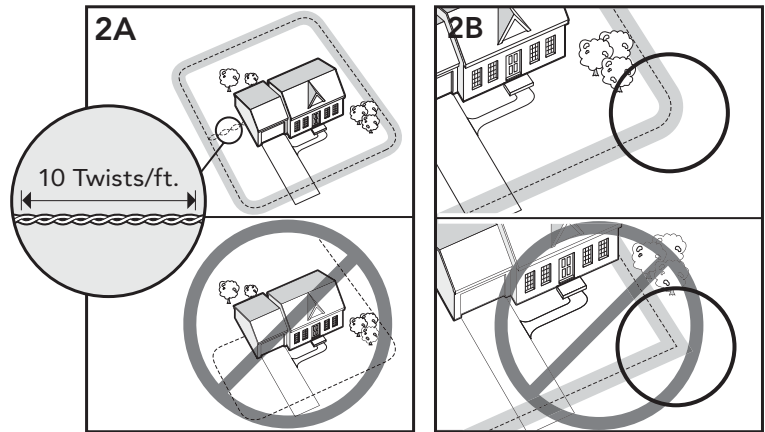

Sample Layouts

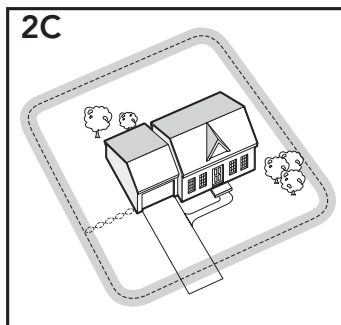

Sample 1: Perimeter Loop (Single Loop) The Perimeter Loop is the most common layout. This will allow your pet to freely and safely roam your entire property (2C). It can also protect gardens, pools and landscaping (2D).

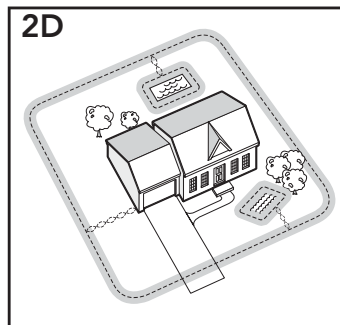

Sample 2 (2E): Perimeter Loop Using Existing Fence (Single Loop) This layout allows you to include your existing fence as part of your layout and keep your pet from jumping out or digging under your existing fence. It reduces the amount of wire which will need to be buried. From the Fence Transmitter, run the wire to **A**, **A** to **B**, **B** to **C**, **C** to **D**, **D** to **E**, **E** to **A**, twist the wires from **A** back to the Fence Transmitter. See the "Install the Boundary Wire" section for more information on attaching the wire to a fence.

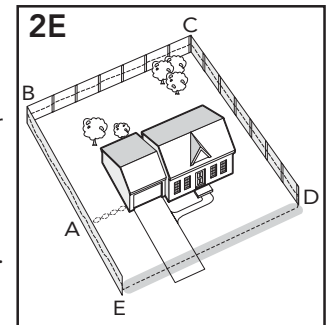

Double Loop

A Double Loop must be used when you are not establishing the Boundary Zone on all sides of your property.

When using a Double Loop, the Boundary Wire must be separated by a minimum of **5 FEET** to avoid canceling the signal. Remember that a Double Loop will require twice as much wire.

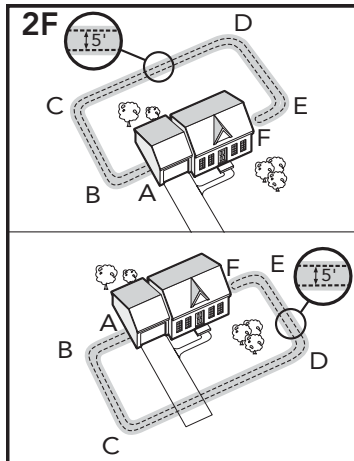

Sample 3 (2F): Front or Back Yard Only (Double Loop) From the Fence Transmitter, run the wire to **A**, **A** to **B**, **B** to **C**, **C** to **D**, **D** to **E**, **E** to **F**, make a U-turn and follow your path all the way back to **A**, keeping the wire separated **at least 5 feet**. Twist the wire from **A** back to the Fence Transmitter.

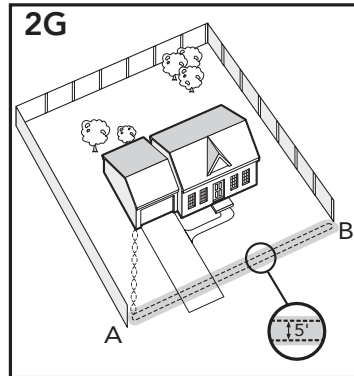

Sample 4 (2G): Front Boundary Only (Double Loop) From the Fence Transmitter, run the wire to **A**, **A** to **B**, **B** back to **A** keeping the wire separated **at least 5 feet**. Twist the wire from **A** back to the Fence Transmitter.

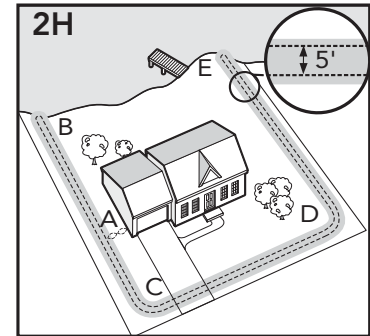

Sample 5 (2H): Lake Access (Double Loop) From the Fence Transmitter, run the wire to **A**, **A** to **B**, make a U-turn and go to **C**, **C** to **D**, **D** to **E**, make a U-turn and follow your path all the way back to **A** keeping wire separated **at least 5 feet**. Twist the wire from **A** back to the Fence Transmitter.

Sample 6 (2J): Wire Loop Attached to Existing Fence (Double Loop) This layout allows you to include your existing fence as part of your layout and keep your pet from jumping out or digging under your existing fence. It reduces the amount of wire which will need to be buried. Run the wire from the Fence Transmitter to **A**, **A** to **B**, **B** to **C**, **C** to **D**, **D** to **E**, **E** to **F**, make a U-turn and follow your path all the way back to **A**, keeping the wire separated **at least 5 feet**. Twist the wire from **A** back to the Fence Transmitter. See the "Install the Boundary Wire" section for more information on attaching the wire to a fence.

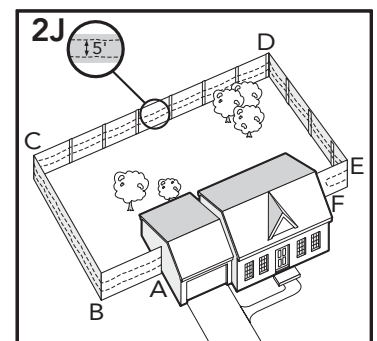

Step 3 Position the Boundary Wire

3

Lay out the Boundary Wire using your planned boundary and test the system BEFORE burying the wire or attaching it to an existing fence. This will make any layout changes easier. Work carefully. A nick in the wire insulation can diminish the signal strength and create a weak area where your pet can escape.

Running the Boundary Wire parallel to and within 10 feet of electrical wires, neighboring containment systems, telephone wires, television or antenna cables, or satellite dishes may cause an inconsistent signal. If you must cross any of these, do so at 90-degree angles (perpendicularly) (3A).

If separating the wire by at least 10 feet from a neighboring containment system's wire does not reduce the inconsistent signal, contact the Customer Care Center at 1-800-732-2677.

To Twist the Boundary Wire

Twisting the Boundary Wire cancels the signal and allows your pet to cross over that area safely (3B). The signal cannot be cancelled by running the wire through plastic or metal piping. Using shielded cable in place of the Boundary Wire will also not cancel the signal. Refer to figure (3C) for the correct method of twisting the wire. You can twist your own wire by cutting two equal lengths of Boundary Wire supplied and twisting them together. Anchor one end of the wires to something secure and insert the other end in a power drill. Pull the wire taut. The drill enables you to twist the wire quickly. Twist the Boundary Wire 10 to 12 times per foot to cancel the signal. Once you have completed your boundary layout, insert the twisted wire into the transmitter.

To Splice or Repair the Boundary Wire

If you need additional Boundary Wire to expand your wire loop, you will need to splice the wires together. Note the locations of all splices for future reference.

Strip approximately $\frac{3}{8}$ inch of insulation off the ends of the Boundary Wires to be spliced (3D). Make sure the copper Boundary Wire is not corroded. If the Boundary Wire is corroded, cut it back to expose clean copper wire.

Insert the stripped ends into the wire nut and twist the wire nut around the wires. Ensure that there is no copper exposed beyond the end of the wire nut. Tie a knot 3 to 4 inches from the wire nut (3E). Ensure that the wire nut is secure on the wire splice.

Once you have securely spliced the wires together, open the lid of the gel-filled splice capsule and insert the wire nut as deeply as possible into the waterproof gel inside the capsule (3F). Snap the lid of the capsule shut (3G). For proper system performance, the splice connection must be waterproof.

If your splice pulls loose, the entire system will fail. Make sure your splice is secure. Additional gel-filled splice capsules and wire nuts are available through the Customer Care Center.

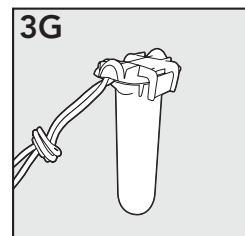
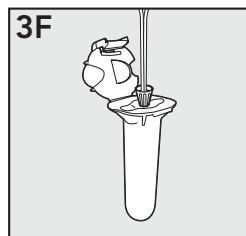
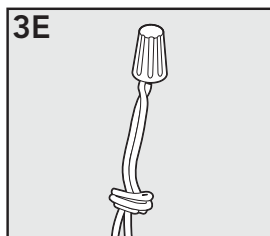
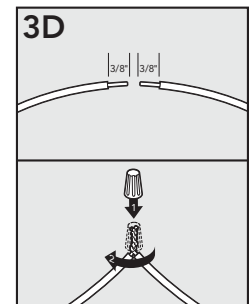
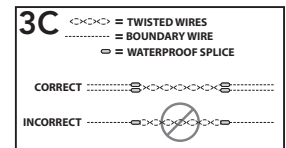
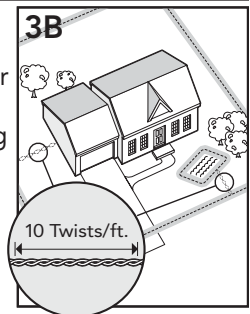
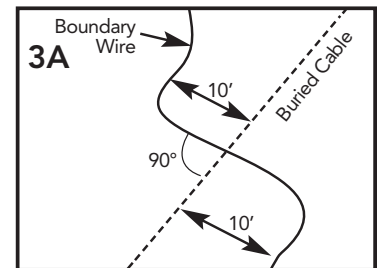

Additional Boundary Wire

Extra direct burial Boundary Wire can be purchased in 500 foot spools at the store where you purchased the kit or through the Customer Care Center at 1-800-732-2677.

Note: When adding Boundary Wire, it must act as a continuous loop.

The table at right indicates the approximate length of Boundary Wire needed for a square, Single Loop layout. Length will vary due to the amount of twisted wire and layout used.

Acres	Feet of Wire Needed
1/4	415
1/3	480
1/2	590
1	835
2	1180
5	1870
10	2800

Step 4 Connect the Wires to the Fence Transmitter

Boundary Wire (4A)

1. Run the Boundary Wire to the Fence Transmitter through a window, under a door, through a crawl space vent, or any other appropriate available access. You can also drill a hole through your wall.
2. Strip 3/8 inch of insulation from the ends of the Boundary Wire.
3. Press the red tabs on the Fence Transmitter and insert the twisted wire into the Boundary Wire Terminals. Make sure the wires do not touch each other at the terminals.
4. Turn the Boundary Width Control knob to 10. This will set the Boundary Width at the maximum width.
5. Plug the Power Adapter into the Power Jack and AC Power Outlet.
6. The Power Light and Loop Indicator Lights should come on. If this does not happen, see the "Troubleshooting" section.

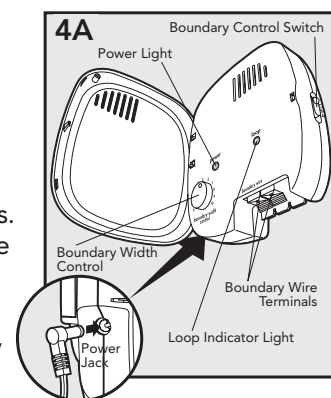

⚠ WARNING

- Do not install, connect, or remove your system during a lightning storm. If the storm is close enough for you to hear thunder, it is close enough to create hazardous surges.
- Risk of electric shock. Use the Fence Transmitter indoors in dry location only.

CAUTION

If possible, DO NOT use an AC circuit protected with a Ground Fault Circuit Interrupter (GFCI) or Residual Current Device (RCD). In rare cases, nearby lightning strikes may cause the GFCI or RCD to trip. Without power your dog may be vulnerable to escape. You will have to reset the GFCI or RCD to restore power to the system.

NOTICE

For added protection, when unused for long periods of time or prior to thunderstorms, unplug from the wall outlet and disconnect the loop boundary wires. This will prevent damage to the transmitter due to surges.

Surge Protection

Lightning strikes within 1-2 miles of your installation can create current surges or spikes which may damage your unprotected electronic pet containment system. The LP-4100-1 Surge Protector is designed to protect your In-Ground Fence™ from surges or spikes that can reach it via your AC power connection and/or your buried Boundary Wire.

Important: Standard Surge Protectors will not protect the Transmitter because they do not contain protection for the Boundary Wire. Nearly all damage to the Transmitter results from power surges or spikes traveling through the Boundary Wire and not the power adapter.

You may purchase a Surge Protection Kit through the Customer Care Center. The Surge Protection Kit protects the system against surges that travel through the power source and/or the Boundary Wire.

Step 5 Prepare the Receiver Collar

Your Receiver Collar comes with short Contact Points. Long Contact Points for pets with long or thick hair are available through our Customer Care Center. Tighten the Contact Points using Test Light Tool (5A) one-half turn beyond finger tight. Check the tightness weekly.

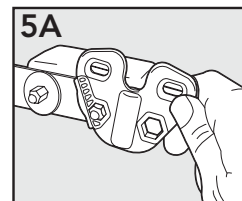

To Insert and Remove the Battery

Note: Do not install the battery while the Receiver Collar is on your pet.

1. Remove the screws with a Phillips screwdriver.
2. Remove the Battery Lid (5B).
3. Install a 9-volt alkaline battery (5C).
4. Replace the Battery Lid (5C).
5. Reinstall the screws. Do not over-tighten the screws.

If the Receiver Indicator Light is flashing every 4 to 5 seconds, battery replacement is required. Remove the old battery from the Receiver Collar. Discharge all power by holding the correction level button down until the light is no longer illuminated. Replace with a new battery.

A replacement PetSafe® 9-volt alkaline battery (PAC11-12067) can be found at many retailers. Contact the Customer Care Center or visit our web site at www.petsafe.net to locate a retailer near you.

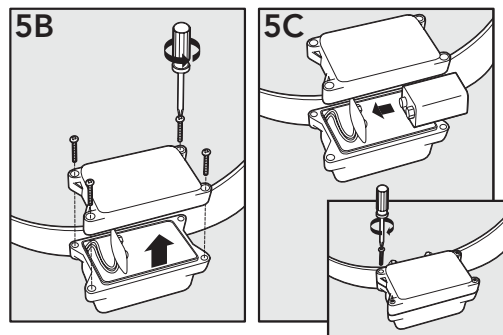

To Set the Static Correction Level

Read all steps before attempting to set the Static Correction Level.

1. Remove the clear plastic cover with the Test Light Tool to expose the Correction Level Button (5D).
2. With the battery installed, press the Correction Level Button and release when the Receiver Indicator Light lights up (5E).
3. The Receiver Indicator Light will emit a series of flashes representing the Static Correction Level.
4. Increase the Static Correction Level by pressing and releasing the Correction Level Button within 5 seconds of the previous series of flashes.
5. After setting the Static Correction Level, replace the cover to protect the Correction Level Button.

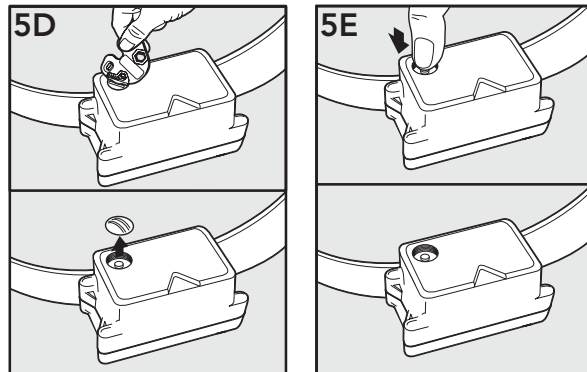

The Static Correction levels increase in strength from 1 to 5. Pushing the Correction Level Button while the Receiver Collar is on level 5 will cause the Receiver Collar to revert to Level 1. Refer to the Function and Response Table to choose the Static Correction level that best fits your pet.

The Receiver Collar will emit a Warning Tone and vibrate whenever your pet enters the Warning Zone, no matter what correction level the Receiver Collar is set to. If your pet continues into the Correction Zone, and the Receiver Collar is set to level 2 or above, he will receive a Static Correction. The Receiver Collar is equipped to automatically increase the level of Static Correction the longer your pet remains in the Static Correction Zone if the collar is set at level 2 or above.

The Receiver Indicator Light acts as a low battery indicator, flashing every 4 to 5 seconds when battery replacement is required. Test your Receiver Collar at least once a month to verify that it is functioning properly and that it activates at the Boundary Wire.

Anti-Linger Prevention

The Anti-Linger Prevention feature keeps your dog from staying in the Warning Zone for long periods of time and draining the Receiver Collar battery. Your dog will hear a warning tone when he reaches the Warning Zone. If your dog does not return to the Pet Area after two seconds, he will receive a continuous Static Correction until he returns to the Pet Area.

Run Through Prevention

This system includes a unique “run-through” prevention so that your dog cannot escape the Pet Area without receiving an increased level of Static Correction. The Receiver Collar automatically increases the Static Correction when your dog continues more than 20% of the way through the pet fencing Boundary Width. For example, if the signal is detected 10 feet from the wire and your dog enters the Static Correction Zone, this feature is activated when he is approximately 8 feet from the Boundary Wire. Your dog will then receive a Static Correction that is at an increased level corresponding to the Static Correction level setting on the Receiver Collar. The Receiver Collar is equipped to automatically increase the level of Static Correction the longer your pet remains in the Static Correction Zone if the collar is set at level 2 or above. The Run Through Prevention sound is an intermittent tone.

Over Correction Protection

In the unlikely event that your pet “freezes” in the Static Correction Zone, this feature limits the static correction duration to a maximum of 30 seconds. While the system locks out further static correction, the warning tone will continue until the pet leaves the Static Correction Zone.

Function and Response Table

Indicator Light Response	Static Correction Level	Receiver Collar Function	Temperament of Pet
1 Flash	1	No Static Correction, Tone Plus Vibration	Initial Training Mode
2 Flashes	2	Low Static Correction	Timid
3 Flashes	3	Medium Static Correction	Timid or Average
4 Flashes	4	Medium High Static Correction	Average or High Energy
5 Flashes	5	High Static Correction	High Energy
Flashes once every 4 to 5 seconds		Indicates Low Battery	

Step 6 Set the Boundary Width and Test the Receiver Collar

With the Boundary Wire in place and properly connected, it is time to set the containment field and test the system.

CAUTION The Receiver Collar should NOT be on your dog when the system is tested.

Note: The Receiver Collar is waterproof, which can make the tone hard to hear.

The flashing Test Light when held to the Contact Points indicates the Receiver Collar is delivering Static Correction. To best utilize the automatic Run-Through Prevention feature, the containment Boundary Width should extend at least 6 to 10 feet on each side of the Boundary Wire (total Boundary Width of 12 to 20 feet).

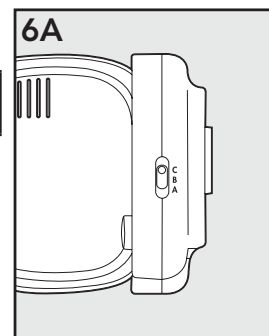

1. Apply Power to the Fence Transmitter with the supplied Power Adapter.
2. Set the Boundary Width Control Switch (located on the side of the Fence Transmitter) (6A) to the A, B, or C setting based on the total length of Boundary Wire used. Setting B is used for most properties. The following table will indicate the proper setting.
3. The width of the containment field is adjusted using the transmitter's Boundary Width Control knob. Turn the knob counter clockwise until the alarm sounds and the Loop Indicator Light is no longer lit. Turn the knob clockwise and increase by 2 numbers. The alarm should turn OFF and the light should turn ON.

Amount of Wire	Setting
Greater than 2400 feet	A
Up to 1300 feet	B
1300 to 2400 feet	C

CAUTION

The Receiver Collar should not be on your dog when the system is tested. Your pet may receive an unintended correction.

4. Place battery in Receiver Collar. To identify the Warning and Static Correction Zones make sure the Receiver Collar is set at level 5 (see Step 5).
5. Test the Boundary Width of the system by selecting a section of straight Boundary Wire that is at least 50 feet long. Start inside the center of the containment field.

6. Place the Test Light Tool Contacts on the Contact Points on the Receiver Collar (6B,6C). Hold the Receiver Collar at your dog's neck height with the Contact Points pointing up (6D) and the Correction Level Button facing the Boundary Wire. Slowly walk toward the Boundary Wire until you hear the warning tone (6E). When you hear the warning tone, you have identified the Boundary Width distance (Static Correction Zone). Two seconds after the warning tone, the test light will begin to flash. This flashing light can aid you in identifying the

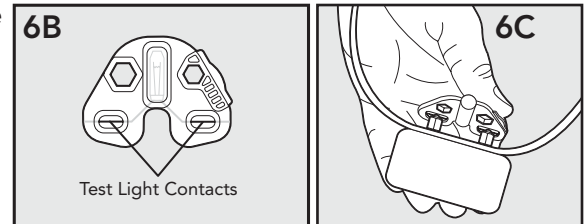

Boundary Width should you have difficulty hearing the tone. To avoid having the Receiver Collar go into Over Correction Protection mode, walk back into the Pet Area until the toning stops. If the Receiver Collar does not tone at the desired range, adjust the Boundary Width Control knob to obtain the desired range. Turning the Boundary Width Control knob clockwise increases the Boundary Width while turning it counterclockwise decreases it (6F). Repeat this activity as needed until the Receiver Collar tones between 6 to 10 feet from the Boundary Wire. If using a Double Loop layout, you may need to increase the separation of the Boundary Wire and/or increase the size of the Boundary Width to achieve the desired range.

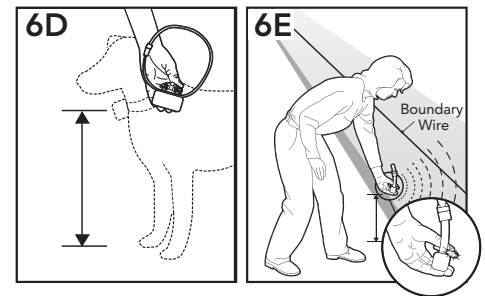

7. Test in a number of different locations around the containment area until you are satisfied that the system is functioning properly.
8. Next, walk all around the Pet Area to ensure there are no areas where the Receiver Collar may activate from signals coupled onto buried wires or cables. Test the collar in and around the inside of the house as well. As mentioned, cable and wires from cable TV, electrical or telephone lines may conduct pet fencing signals inside and outside the house that can activate the dog's collar accidentally. While rare, if this occurs your Boundary Wire is probably too close to these outside lines and should be moved or modified as shown in Figure (3A).

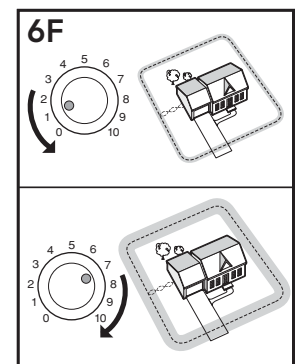

9. To test the run-through prevention feature, walk towards the Boundary Wire. The Receiver Collar should tone and the Test Light should flash brighter as you enter the run-through area (6G). If you are satisfied that your system is functioning properly, you are ready to start burying the Boundary Wire. If the Receiver Collar did not tone or the Test Light did not flash, see the “Troubleshooting” section.

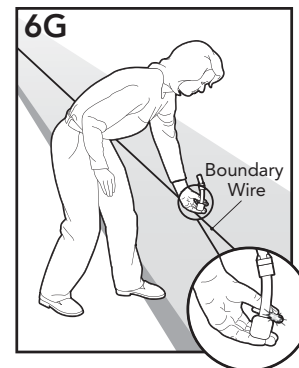

Step 7 Install the Boundary Wire

NOTICE

Before you begin installing the Boundary Wire, unplug the Fence Transmitter power adapter from the outlet.

To Bury the Boundary Wire

Burying the Boundary Wire is recommended to protect it and prevent disabling the system.

1. Cut a trench 1-3 inches deep along your planned boundary.
2. Place the Boundary Wire into the trench maintaining some slack to allow it to expand and contract with temperature variations.
3. Use a blunt tool such as a wooden paint stick to push the Boundary Wire into the trench. Be careful not to damage the Boundary Wire insulation.

To Attach the Boundary Wire to an Existing Fence

The Boundary Wire of the PetSafe® Stubborn Dog In-Ground Fence™ can be attached to a chain link fence, split rail fence, or a wooden privacy fence. The Boundary Wire can be attached as high as needed. However, make sure the Boundary Width is set at a high enough range for the pet to receive the signal. If using a Double Loop with an existing fence at least five feet tall, run the Boundary Wire on top of the fence and return it on the bottom of the fence to get the five foot separation needed.

- **Chain Link Fence (7A):** Weave Boundary Wire through the links or use plastic quick ties.
- **Wooden Split Rail or Privacy Fence (7A):** Use staples to attach Boundary Wire. Avoid puncturing the insulation of the Boundary Wire.
- **Double Loop with an Existing Fence:** Run the Boundary Wire on top of the fence and return it on the bottom of the fence to get the five foot separation needed.
- **Gate (Single Loop) (7B) :** Bury the Boundary Wire in the ground across the gate opening. *Note: The signal is still active across the gate. Your pet cannot pass through an open gate.*
- **Gate (Double Loop) (7B):** Bury both Boundary Wires across the gate opening while keeping them at least 5 feet apart.

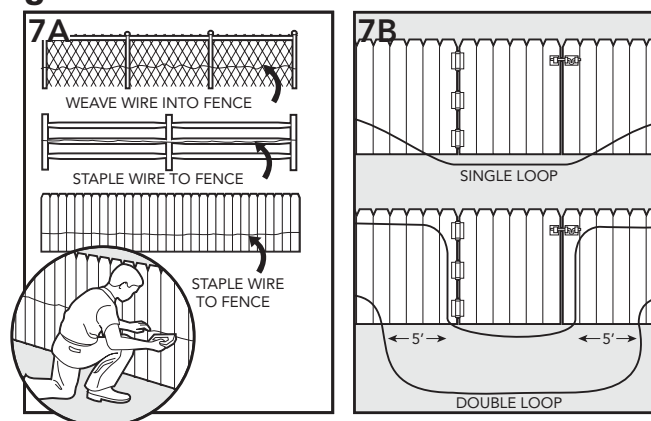

To Cross Hard Surfaces (driveways, sidewalks, etc.)

⚠️ WARNING

Follow all safety instructions for your power tools. Be sure to always wear your safety goggles.

- **Concrete Driveway or Sidewalk (7C):** Place the Boundary Wire in a convenient expansion joint or create a groove using a circular saw and masonry blade. Place the Boundary Wire in the groove and cover with an appropriate waterproofing compound. For best results, brush away dirt or other debris before patching.
- **Gravel or Dirt Driveway (7D):** Place the Boundary Wire in a PVC pipe or water hose to protect the Boundary Wire before burying.

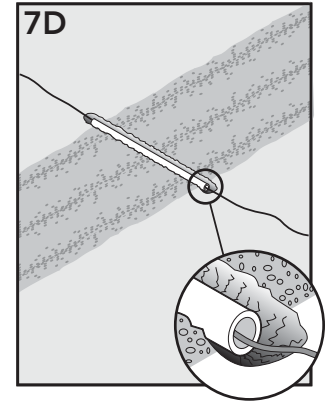
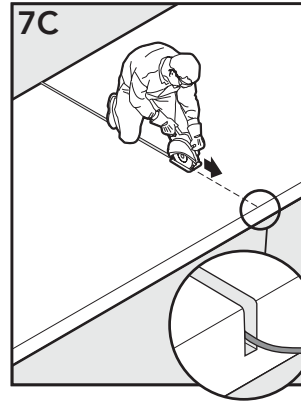

Step 8 Place the Boundary Flags

8

The Boundary Flags are visual reminders for your pet of where the Warning Zone is located.

1. Place the Test Light contacts on the contact points and hold the Receiver Collar at your pet's neck height.
2. Walk towards the Warning Zone until the Receiver Collar beeps (8A).
3. Place a Boundary Flag in the ground (8B).
4. Walk back into the Pet Area until the beeping stops.
5. Repeat this process around the Warning Zone until it is marked with Boundary Flags every 10 feet.

Note: If you cannot hear the beep, see the Test Light Instructions in Step 6.

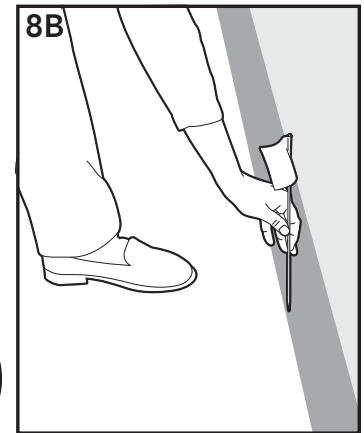
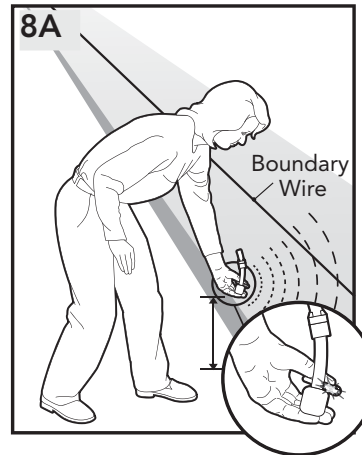

⚠️ CAUTION

To prevent an unintended correction, after the Boundary Flags have been placed, be sure to set the static correction on the Receiver Collar back to level 1 Tone Only.

Step 9 Fit the Receiver Collar

Important: The proper fit and placement of your Receiver Collar is important for effective training. The Contact Points must have direct contact with your pet's skin on the underside of his neck.

CAUTION

Please read and follow the instructions in this manual. Proper fit of the collar is important. A collar worn for too long or made too tight on the pet's neck may cause skin damage. Ranging from redness to pressure ulcers; this condition is commonly known as bed sores.

- Avoid leaving the collar on the dog for more than 12 hours per day.
- When possible reposition the collar on the pet's neck every 1 to 2 hours.
- Check the fit to prevent excessive pressure; follow the instructions in this manual.
- Never connect a lead to the electronic collar; it will cause excessive pressure on the contacts.
- When using a separate collar for a lead, don't put pressure on the electronic collar.
- Wash the dog's neck area and the contacts of the collar weekly with a damp cloth.
- Examine the contact area daily for signs of a rash or a sore.
- If a rash or sore is found, discontinue use of the collar until the skin has healed.
- If the condition persists beyond 48 hours, see your veterinarian.
- For additional information on bed sores and pressure necrosis, please visit our website. These steps will help keep your pet safe and comfortable. Millions of pets are comfortable while they wear stainless steel contacts. Some pets are sensitive to contact pressure. You may find after some time that your pet is very tolerant of the collar. If so, you may relax some of these precautions. It is important to continue daily checks of the contact area. If redness or sores are found, discontinue use until the skin has fully healed. You may need to trim the hair in the area of the Contact Points. Never shave the dog's neck; this may lead to a rash or infection.

To assure a proper fit, please follow these steps:

1. Make sure that the battery is not installed in the Receiver Collar.
2. Start with your pet standing comfortably (9A).
3. Place the Receiver Collar on your pet so that the "PetSafe" logo is facing your pet's chin. Center the Contact Points underneath your pet's neck, touching the skin.
4. The Receiver Collar should fit snugly, yet loose enough to allow one finger to fit between a contact point and your pet's neck (9B). Allow your pet to wear the collar for several minutes then recheck the fit. Check the fit again as your pet becomes more comfortable with the Receiver Collar.
5. Once you are satisfied with the fit of the Receiver Collar then you may trim any excess collar strap as follows (9C):
 - a. Mark the desired length of the Receiver Collar with a pen. Allow for growth if your pet is young or grows a thick winter coat.
 - b. Remove the Receiver Collar from your pet and cut off the excess.
 - c. Before placing the Receiver Collar back onto your pet, seal the edge of the cut collar by applying a flame along the frayed edge.

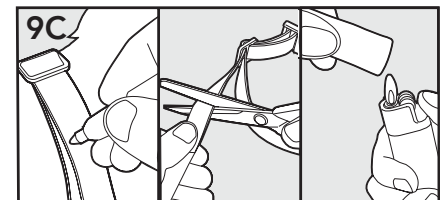
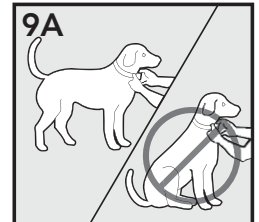

To Re-Thread the Collar

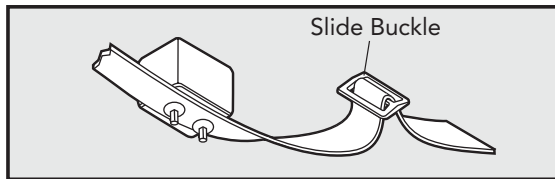

The slide buckle prevents the collar from becoming loose around your pet's neck.

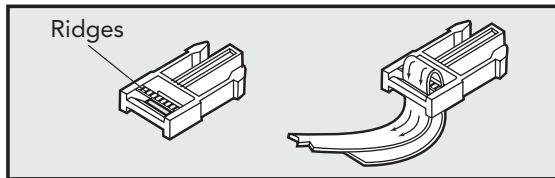

The ridges must be facing up; the collar will slip if it is not properly threaded.

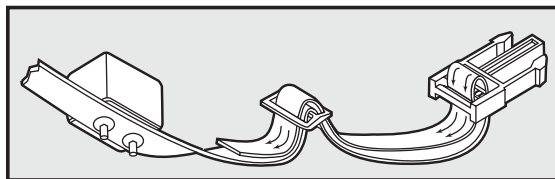

Training Guide

Be Patient With Your Pet

Important: Proper training of your pet is essential to the success of the PetSafe® Stubborn Dog In-Ground Fence™. Read this section completely before beginning to train your pet. Remember that the PetSafe® Stubborn Dog In-Ground Fence™ is not a solid barrier.

- Have fun with your pet throughout the training process. Training should be fun, fair, firm and consistent.
- Train for 10 to 15 minutes at a time. Don't try to do too much too quickly. More-frequent short sessions are better than less-frequent longer sessions.
- If your pet shows signs of stress, slow down the training schedule, add additional days of training, or increase the amount of play time with your pet in the Pet Area. Common stress signals include:
 - **Pet pulling on leash toward the house**
 - **Ears tucked**
 - **Tail down**
 - **Body lowered**
 - **Nervous / frantic movement or stiffening of pet's body**
- Your pet must be completely comfortable near the Boundary Flags at the end of every training session. Spend at least 5 minutes of "play time" at the completion of each session within 10 feet of the Boundary Flags.
- Finish each training session on a positive note with lots of praise and play.
- Remove the Receiver Collar after each training session.
- Be sure to contain your pet by another means during the training period (e.g. pen, tie-out, leash, etc.).
- During training, if you need to take your pet out of the Pet Area, remove the Receiver Collar and either pick your pet up or put him in the car to pass out of the Pet Area.
- Even if you think your pet is responding well to the training, complete the entire training. Reinforcement is important!

Phase Day 1 - Boundary Awareness

1

Tone Plus Vibration Training Mode

Perform three training sessions per day, each lasting 10-15 minutes.

Goal:

To have your pet learn that the Boundary Flags and warning beep and vibration from the Receiver Collar define the new Pet Area.

Setup:

- Program the Static Correction Level on the Receiver Collar to Level 1 Tone Plus Vibration training mode and place it on your pet's neck..
- Put a separate non-metallic collar on your pet's neck ABOVE the Receiver Collar and attach a leash.

CAUTION Be sure the extra collar does not put pressure on the Contact Points.

- Have tiny pieces of treats that your pet will find desirable available (hot dogs or lunch meat work well).
- Have your pet's favorite play toy available.

Steps:

1. Begin by walking your pet on a leash in the Pet Area. Calmly praise and talk to your pet.
2. Move toward the Boundary Flags (10A). Keep your mood happy.
3. With full control of your pet on a leash, walk to the flags. As your pet enters the Static Correction Zone, the Receiver Collar will begin to beep and vibrate (10B). Allow your pet to stay in the Static Correction Zone for up to 2 seconds then gently help him back into the Pet Area (10C). Immediately praise and offer your pet a treat as he enters the Pet Area, even if you have helped with the leash.
4. Repeat this process at the same Boundary Flag until your pet resists going into the Static Correction Zone.
5. Aim to master 3-4 Boundary Flags per session. Make this FUN! Praise if your pet quickly retreats or resists going into the Static Correction Zone.

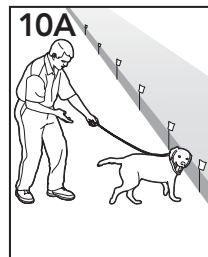

Phase Days 2 thru 4 - Continue Boundary Awareness

2

Introduction to Static Correction

Perform three training sessions per day, each lasting 10-15 minutes.

Goal:

To train your pet to stay in the Pet Area and respect the boundary.

Setup:

- Program the Static Correction Level on the Receiver Collar to Level 2 and place it on your pet's neck.
- Put a separate non-metallic collar on your pet's neck ABOVE the Receiver Collar and attach a leash.

CAUTION Be sure the extra collar does not put pressure on the Contact Points.

- Have tiny pieces of treats available (hot dogs or lunch meat work well).
- Have your pet's favorite play toy available.

Steps:

1. Repeat steps 1-5 in Phase One.
 2. If your pet does not respond to the Static Correction, confirm that the Receiver Collar is fitting properly according to Step 9 on page 17.
 3. If the Receiver Collar is fitted properly and your pet does not respond to the Static Correction, increase the Static Correction Level by 1. Watch for slight reactions at first such as ears up, head turned, looking at the ground.
 4. Stay at the same flag until your pet resists going into the Static Correction Zone.
-

Phase Days 5 thru 8 - Distraction Phase

3

Perform three training sessions per day, each lasting 10 to 15 minutes.

Goal:

To train your pet to stay within the Pet Area with distractions outside of the Pet Area.

Setup:

- Program the Static Correction Level on the Receiver Collar to level 2 or higher depending on the reaction results from days 2 thru 4.
- Put a separate non-metallic collar on your pet's neck ABOVE the Receiver Collar and attach a leash.

CAUTION Be sure the extra collar does not put pressure on the Contact Points.

- Have tiny pieces of treats available (hot dogs or lunch meat work well).
- Have your pet's favorite play toy available.
- Create distractions to tempt your pet to enter the Static Correction Zone, such as:
 - Have a family member cross from inside the Pet Area to outside of it.
 - Throw a ball or treat outside of the Pet Area.
 - Have a neighbor walk their pet outside of the Pet Area.
- Gradually increase distraction level. **Never coax or call your pet out of the pet area.**

Steps:

1. With full control of your pet on a leash, have the distraction presented.
2. If your pet does not move toward the distraction, praise and offer a treat.
3. If your pet does react to the distraction, allow him to go into the Static Correction Zone.
4. Help your pet back into the Pet Area if he does not turn back after 2 seconds.
5. Treat and praise your pet anytime he comes back into the Pet Area with or without help.
6. Repeat this process with other distractions. Use other family members during this process.
7. If your pet does not respond to the Static Correction, confirm that the Receiver Collar is fitting properly according to Step 9 on page 17.
8. If the Receiver Collar is fitted properly and if your pet does not respond to the Static Correction, increase the Static Correction Level by 1.

Phase Days 9 thru 14 - Unleashed Supervision

4

Training sessions should start at 10-15 minutes, gradually increasing to over an hour.

Your pet is ready for this step only when he clearly avoids the entire Static Correction Zone, regardless of any distractions or temptations. During this step, do not leave your pet unattended.

Goal:

To give your pet free run of the Pet Area off the leash.

Setup:

Adjust the Receiver Collar to the permanent setting appropriate for your pet.

Steps:

1. Enter the Pet Area with your pet wearing the Receiver Collar.
2. Walk around the yard and play with your pet, staying within the Pet Area at all times.
3. Preoccupy yourself with another task in the yard while watching your pet.
4. Should your pet escape, take the Receiver Collar off and lead him back into the Pet Area.

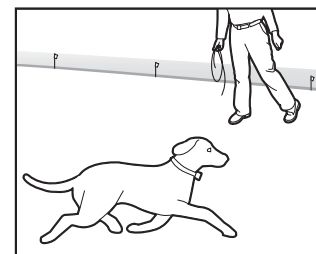

Phase Days 15 thru 30 - Pet Monitoring

5

Your pet is ready to run! Check in on your pet at regular intervals.

Note: After you are satisfied your pet's training is complete, remove every other Boundary Flag every 4 days until all flags are removed. Save Boundary Flags for future use.

Taking Your Pet Out of the Pet Area

Important: Remove the Receiver Collar and leave it in the Pet Area.

Once your pet learns the Boundary Zone, he will be reluctant to cross it for walks or car rides.

Option 1: Replace the Receiver Collar with a regular collar. Put your pet in a car that is within the Pet Area and drive him out of the Pet Area.

Option 2: Replace the Receiver Collar with a regular collar and leash. Walk your pet out of the Pet Area while giving a command such as "OK" at a specific place of the Boundary Zone (the end of your driveway, sidewalk, etc.). Always leave the Pet Area with a leash at this place and your pet will associate leaving the Pet Area only on a leash, only at this place, and only with a person. You may initially need to convince your pet to leave the Pet Area with a food treat and lots of praise.

Note: You may also carry your pet out of the Pet Area.

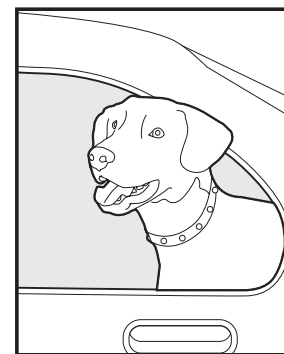

Congratulations! You have now successfully completed the training program.

Accessories

To purchase additional accessories for your PetSafe® Stubborn Dog In-Ground Fence™, contact the Customer Care Center at 1-800-732-2677 or visit our website at www.petsafe.net to locate a retailer near you.

Component	Part Number
Battery - 9-Volt Alkaline	PAC11-12067
Power Adapter for the Fence Transmitter	RFA-372
Surge Protection Kit	LP-4100-1
Replacement Collar Strap	RFA-41-1
Stubborn Dog Receiver Collar	PRF-275-19
Deluxe UltraLight™ Receiver Collar	PUL-275
Additional Boundary Wire	RFA-1
Additional Boundary Flags	RFA-2
Additional Gel-filled Capsules and Wire Nuts	RFA-366
Wire & Flag Accessory Kit	PRFA-500
Accessory Pack	RFA-281
Wire Break Locator	RFA-450

Troubleshooting

Receiver Collar is not beeping or correcting.	<ul style="list-style-type: none"> • Check battery to make sure it is installed properly. • Check that both lights are lit on the Fence Transmitter. If not, perform the “Transmitter Loop Test” (page 25).
The Receiver Collar is beeping, but the pet is not responding to the Static Correction.	<ul style="list-style-type: none"> • Test the Receiver Collar with the Test Light walking toward the Boundary Wire. • If the Test Light flashes, check the fit of the Receiver Collar. • Trim your pet’s fur where the Contact Points touch the neck and/or purchase longer Contact Points by contacting the Customer Care Center. • Increase the Static Correction Level. • Repeat training steps to reinforce training.
The Receiver Collar has to be held on top of the Boundary Wire to activate.	<ul style="list-style-type: none"> • Replace battery. • Adjust Boundary Width Control knob clockwise to increase the distance from the Boundary Wire that the Receiver Collar activates. Verify the Boundary Control Switch is placed at the proper setting according to the amount of Boundary Wire used. (See Step 6) • If using a Double Loop, make sure Boundary Wires are separated at least 5 feet. • If the Receiver Collar still has to be held on top of the Boundary Wire, perform the “System Test” and/or “Transmitter Loop Test”.
The Receiver Collar activates inside the house.	<ul style="list-style-type: none"> • Turn the Boundary Width Control knob counterclockwise to decrease the distance from the Boundary Wire that the Receiver Collar activates. • Make sure the Boundary Wire is not running within 15 feet of the house. The signal can transmit through the walls of your house. • Make sure Boundary Wires are twisted from Boundary to the Fence Transmitter.

<p>The Receiver Indicator Light is flashing every 4 to 5 seconds and I have just installed a new battery.</p>	<ul style="list-style-type: none"> • To reset the low battery indicator, remove the battery from the Receiver Collar. Discharge all power by holding the correction level button down until the light is no longer illuminated. Reinstall battery.
<p>I have an inconsistent signal.</p>	<ul style="list-style-type: none"> • Make sure Fence Transmitter is at least 3 feet from large metal objects or appliances. • Make sure all Boundary Wire turns are gradual with a minimum 3 foot radius. • Make sure the Boundary Wire is not running parallel to and within 10 feet of electrical wires, neighboring containment systems, telephone wires, television or antenna cables, or satellite dishes. • If a neighboring containment system may be causing an inconsistent signal, move the Boundary Wire farther away from the neighboring containment system.
<p>The Power and Loop Indicator Lights are off.</p>	<ul style="list-style-type: none"> • Check that the Power Adapter is plugged into the Fence Transmitter. • Check that the Power Adapter is plugged in properly. • If the system is plugged into a GFCI or RCD outlet, check to see if the circuit has been tripped. Reset the GFCI or RCD circuit if required. • Verify that the outlet is working properly by plugging in a known working item such as a radio. • Try plugging into another 120-volt outlet. • If the lights still do not come on, the Fence Transmitter and/or Power Adapter needs to be replaced. Contact the Customer Care Center. • If a Surge Protector is installed, unplug the Surge Protector and plug the power adapter directly into the outlet. If the Transmitter operates without the Surge Protector, contact the Customer Care Center for a replacement Surge Protector.
<p>The Power Light is on, the Loop Indicator Light is off, and the Fence Transmitter loop alarm is sounding.</p>	<ul style="list-style-type: none"> • Check Boundary Wire connections at the Fence Transmitter for proper connection. • Check for broken or damaged Boundary Wires at outside entry to the house. • Perform the "Transmitter Loop Test" (page 25) to determine if the Fence Transmitter needs to be replaced. • If the Fence Transmitter is functioning properly, you have a break in your Boundary Wire. See the "Wire Break Location Test" (page 25) section in this guide.

Additional Information

- Use care when using a weed eater or when digging near the Boundary Wire to prevent damage.
- The system should only be used with healthy pets. Contact your veterinarian if you have concerns about the medical condition of your pet (medication, pregnant, heart conditions, etc.).
- The PetSafe® Stubborn Dog In-Ground Fence™ is for residential use only.
- The Static Correction will get your pet's attention, but will not cause harm. It is designed to startle, not to punish.
- Test the Receiver Collar at least once a month to verify that it is functioning properly. Check that it activates at the Boundary Wire. Battery life depends upon how often the Receiver Collar is activated.
- Remove the Receiver collar from your pet when indoors for the comfort of your pet.
- Never leave the Receiver Collar on your pet for more than 12 consecutive hours.

System Test

The system test is used to determine the cause of system problems that have not been addressed elsewhere in this guide. You will need a piece of Boundary Wire greater than 15 feet long with $\frac{3}{8}$ inch of insulation removed from each end to use as a test loop wire. Make a note of your Boundary Control Switch setting, Boundary Width Control knob setting, and Receiver Collar setting before beginning the System Test. Follow the steps below to perform the system test:

1. Remove the Receiver Collar from your dog and make sure a good battery is installed in the receiver.
2. Set the Boundary Control switch to B.
3. Set the Receiver Collar Static Correction Level to 5.
4. Disconnect the twisted Boundary Wire from the Boundary Wire terminals on the Fence Transmitter by pressing the red release levers on the connector and pulling the wires free.
5. Insert the two ends of the test loop wire into the Boundary Wire Terminals on the Transmitter.
6. Turn the Boundary Width control knob to 10 and then back to 5.
7. Place the Test Light Tool Contacts on the Contact Points of the Receiver Collar. While holding the Receiver Collar with the Test Light Tool in place, approach the wire from the outside loop. Make a mental note of the distance between you and the wire when the Receiver Collar activates.
8. Turn the Boundary Width Control knob to 10 and repeat Step 7. The distance where the Receiver Collar activates should be greater than that of Step 7.
9. If more than one Receiver Collar is used on the system, repeat the above test on each collar.
10. Interpreting the Results:
 - a. If the Power light or the Loop indicator light are not both lit on the Fence Transmitter, or the alarm is on, there is a problem with the Transmitter. Contact the Customer Care Center.
 - b. If both the Power and Loop indicator lights are on, but the Receiver Collar does not activate on the test loop wire, the Receiver Collar is not working. Contact the Customer Care Center.
 - c. If both the Power and Loop indicator lights are on and the Receiver Collar is activating at different distances on the test loop wire, the problem is in the containment Boundary Wire. Perform the Wire Break Location Test.
11. When testing is complete, return the Boundary Control Switch and the Boundary Width Control setting to their original position.
12. Reconnect the twisted Boundary Wire from the Boundary Wire terminals on the Fence Transmitter by pressing the red release levers on the connector and inserting the wires.
13. Repeat the Boundary Width testing from Step 6 on Page 13 until you achieve the desired Boundary Width between 12 to 20 feet.

Transmitter Loop Test

The Transmitter Loop Test is a simple test to determine the cause of a “Boundary Wire Broken or Disconnected” alarm indication. You will need a short 15 foot piece of Boundary Wire with $\frac{3}{8}$ inch of insulation stripped from both ends.

CAUTION The Receiver Collar should not be on your dog when the system is tested. Your pet may receive an unintended correction.

Verify the transmitter is plugged into the AC power outlet and all Boundary Wire connections at the transmitter are properly connected. If the Transmitter Power light is on, the Loop indicator light is off, and the alarm is on, continue with the following steps:

1. Remove the twisted wire from the Fence Transmitter Boundary Loop terminals by pushing the red release levers on the connector and pulling the wires free.
2. Insert both ends of the 15 foot wire loop into the Boundary Loop Terminals and recheck the Transmitter Loop indicator light and alarm.
 - a. If the Loop indicator light is on and the alarm is off, there is a problem with the Boundary Wire. Check for visible damage to the wire at the entry into the house. If none is observed, perform the Wire Break Location Test to find and correct the wire break in your Boundary Loop.
 - b. If the Loop indicator light is still off and the alarm is on, there is a problem with the Fence Transmitter, Contact the Customer Care Center for assistance.

Wire Break Location Test

Please follow these steps in determining where you have a break in your Boundary Wire:

1. Locate your original splice(s) and verify they have a good, solid connection.
2. Check your yard to determine any possible damage to the Boundary Wire (e.g. recent digging, aerating, rodent burrowing, or any other noticeable disturbance in your yard next to the Boundary Wire).

If you still cannot find the break in the Boundary Wire, there are two options for locating it:

Option 1: Contact the Customer Care Center to purchase a Wire Break Locator (RFA-450) that will locate the break in the Boundary Wire.

Option 2: Follow the procedure below:

1. Unplug the Fence Transmitter.
2. Connect both ends of your twisted Boundary Wire to one Boundary Wire Terminal.
3. Measure and cut a Test Wire which is half the length of your total Boundary Wire footage.
4. Connect one end of Test Wire to the other Boundary Wire Terminal.
5. Locate the halfway point of your boundary and cut the Boundary Wire.
6. Splice the other end of the Test Wire to either side of your Boundary Wire where you cut it in half.
7. Plug in the Fence Transmitter and check the Loop Indicator Light. If the Loop Indicator Light is on, you can assume the break is in the other half of the Boundary Wire.
8. If the Loop Indicator Light did not come on, you may assume there is a break in this portion of the Boundary Wire. However, there is a small chance of having more than one break in your system. Be sure to check both halves of your entire loop.
9. Replace the damaged Boundary Wire with new Boundary Wire.
10. Reconnect the Boundary Wire to the Fence Transmitter.
11. Check the Loop Indicator Light. If the Loop Indicator Light is on, test the system with the Receiver Collar.

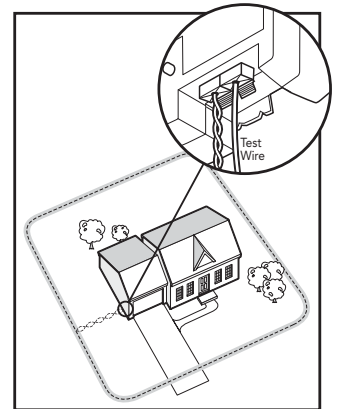

Terms of Use and Limitation of Liability

1. Terms of Use

This Product is offered to you conditioned upon your acceptance without modification of the terms, conditions and notices contained herein. Usage of this Product implies acceptance of all such terms, conditions, and notices.

2. Proper Use

This Product is designed for use with pets where training is desired. The specific temperament of your pet may not work with this Product. We recommend that you not use this Product if your pet is less than 8 pounds or if your pet is aggressive. If you are unsure whether this is appropriate for your pet, please consult your veterinarian or certified trainer.

Proper use includes reviewing the entire Guide provided with your Product and any specific Caution statements.

3. No Unlawful or Prohibited Use

This Product is designed for use with pets only. This pet training device is not intended to harm, injure or provoke. Using this Product in a way that is not intended could result in violation of Federal, State or local laws.

4. Limitation of Liability

In no event shall Radio Systems® Corporation be liable for any direct, indirect, punitive, incidental, special or consequential damages, or any damages whatsoever arising out of or connected with the use or misuse of this Product. Buyer assumes all risks and liability from the use of this Product.

5. Modification of Terms and Conditions

Radio Systems® Corporation reserves the right to change the terms, conditions and notices under which this Product is offered.

Compliance

FCC/Canada

This Class B digital apparatus complies with Canadian ICES-003. This equipment has been tested and found to comply with the limits for a Class B digital device, pursuant to Part 15 of the FCC Rules. These limits are designed to provide reasonable protection against harmful interference when the equipment is operated in a residential environment. This equipment generates, uses, and can radiate radio frequency energy and, if not installed and used in accordance with the instruction guide, may cause harmful interference to radio communications. However, there is no guarantee that interference will not occur in a practical installation. If this equipment causes harmful interference to radio or television reception, which can be determined by turning the equipment off and on, the user is encouraged to try to correct the interference by one or more of the following measures:

- Relocate the interfered receiving antenna.
- Increase the separation between the equipment and receiver.
- Connect the equipment into an outlet on a circuit different to that to which the receiver is connected.
- Contact the Customer Care Center at 1-800-732-2677.

This device complies with Industry Canada Rules. This device complies with part 15 of the FCC Rules. Operation is subject to the following two conditions: (1) This device may not cause harmful interference, and (2) this device must accept any interference received, including interference that may cause undesired operation.

Unauthorized changes or modifications to the equipment, not approved by Radio Systems® Corporation, could result in not meeting compliance with FCC regulations and could void the user's authority to operate the equipment.

Australia

This device complies with the applicable EMC requirements specified by the ACMA (Australian Communications and Media Authority).

Customer Care International

USA & Canada - Tel: 800-732-2677

Monday - Friday 8 AM - 8 PM / Saturday 9 AM – 5 PM

Australia - Tel: 1800 786 608

Monday - Friday 8:30 AM - 5 PM

New Zealand - Tel: 0800 543 054

Monday - Friday 10:30 AM - 7 PM

This product has the benefit of a limited manufacturer's warranty. Details of the warranty applicable to this product and its terms can be found at www.petsafe.net and/or are available by sending a stamped addressed envelope to PetSafe® Ltd. Redthorn House, Unit 9, Chorley West Business Park, Ackhurst Road, Chorley, Lancashire PR7 1NL, United Kingdom.

Layout Grid

Mounting Template

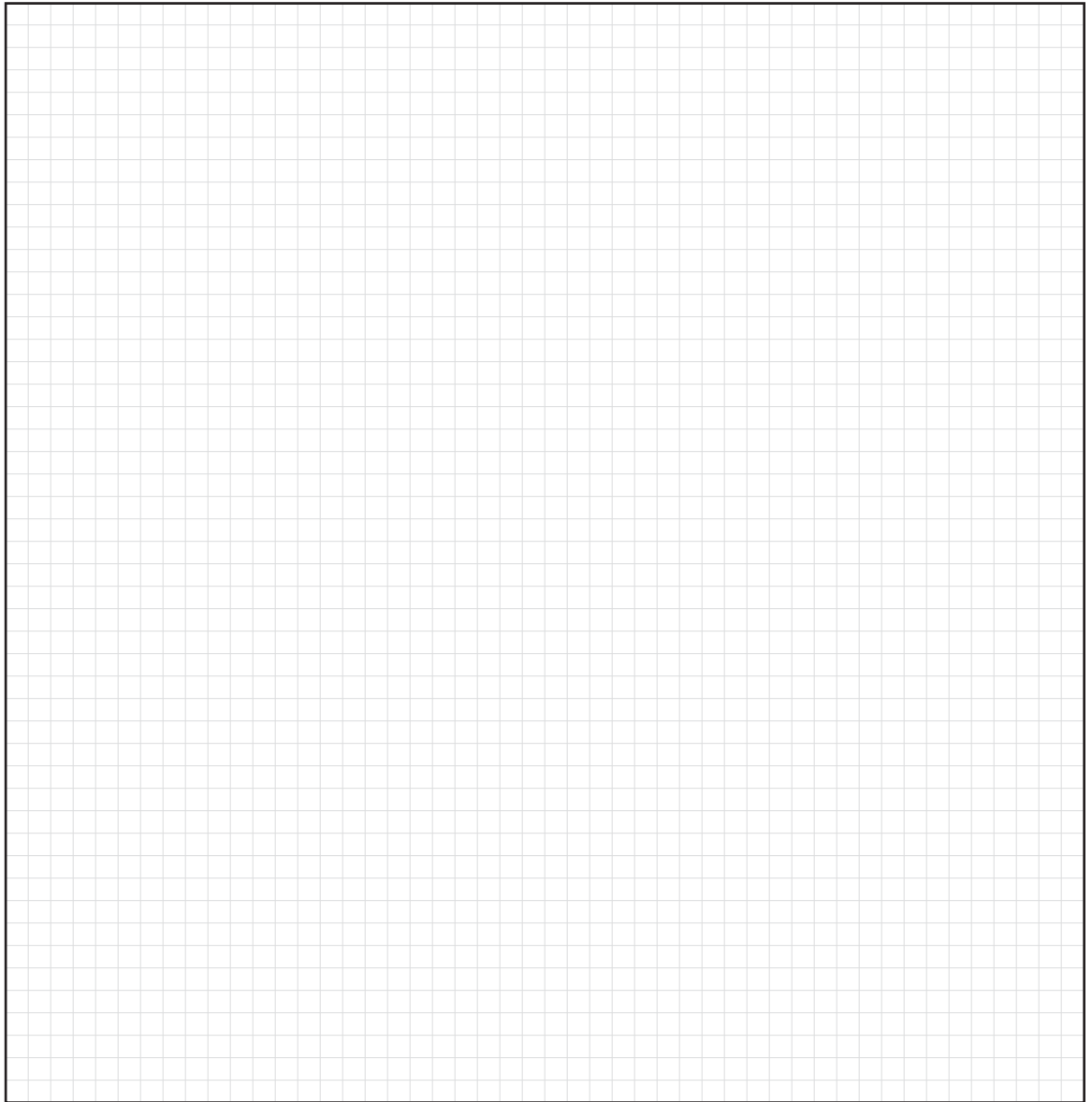
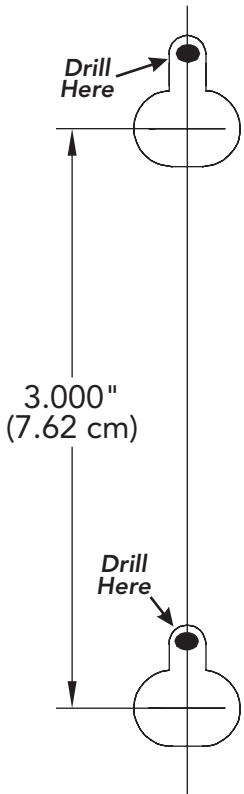

Radio Systems® Corporation
10427 PetSafe Way
Knoxville, TN 37932
1-800-732-2677
www.petsafe.net
Protected by US Patents 6,538,617.
400-1416/2

©2006 Radio Systems Corporation