

Watt	1.354
BTU	4.619
kcal / h	1.164

Elan 12-6060

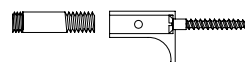
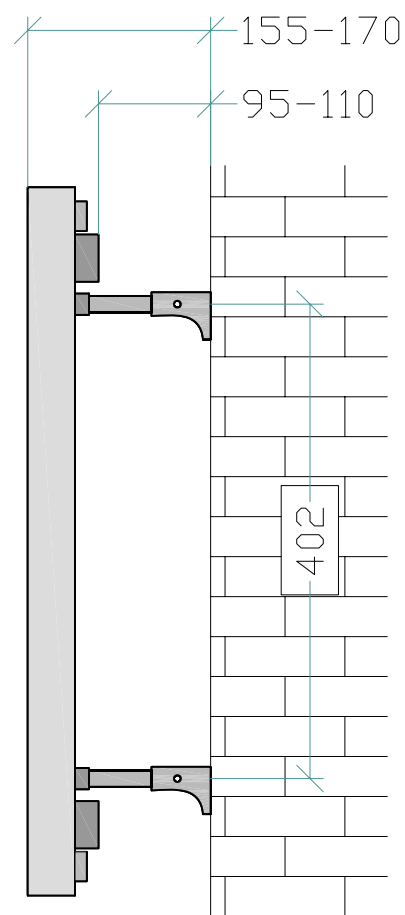
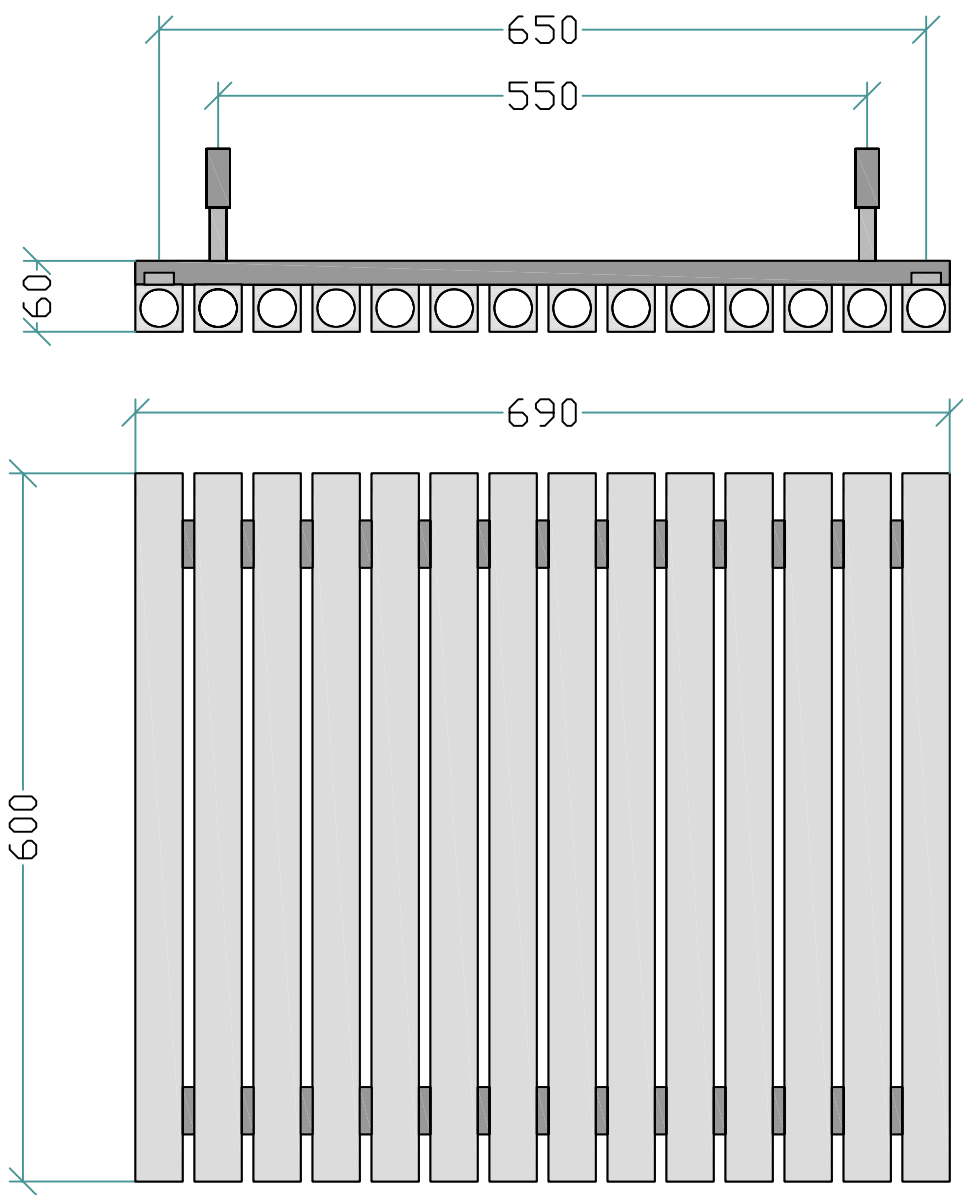

Watt	1.579
BTU	5.388
kcal / h	1.358

Elan 14-6060

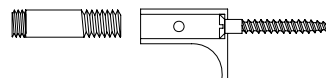
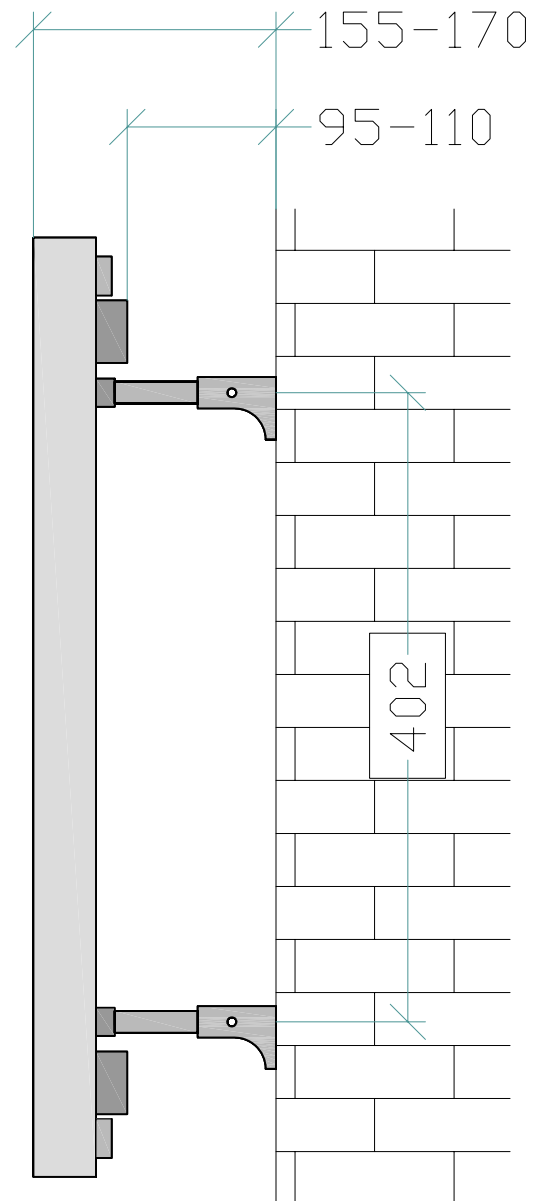
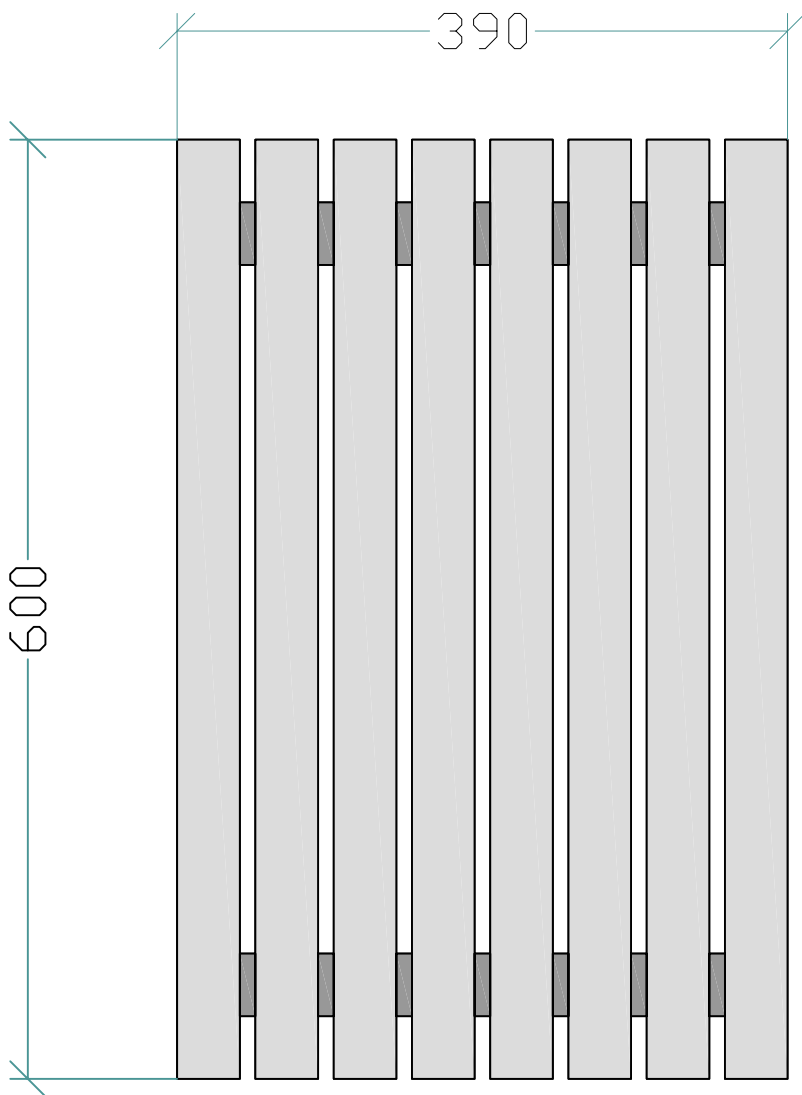
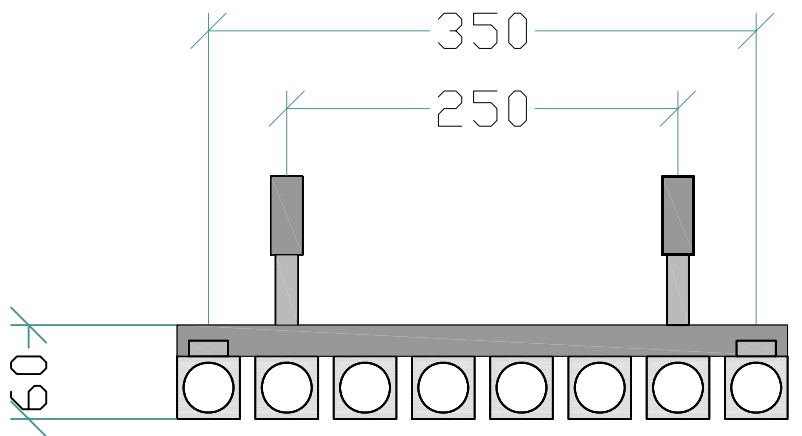

Watt	902
BTU	3.079
kcal / h	776

**Elan 08-6060**

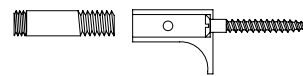
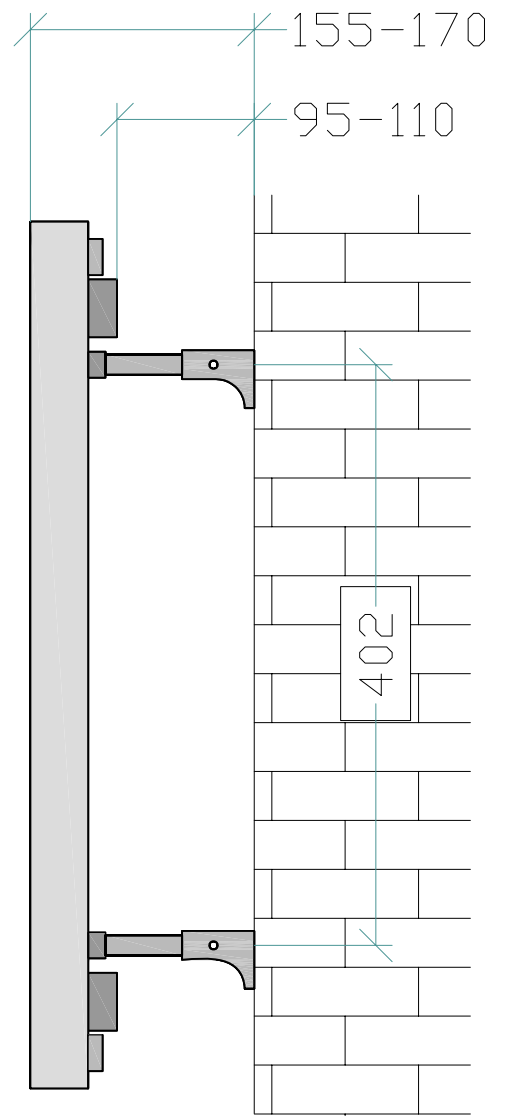
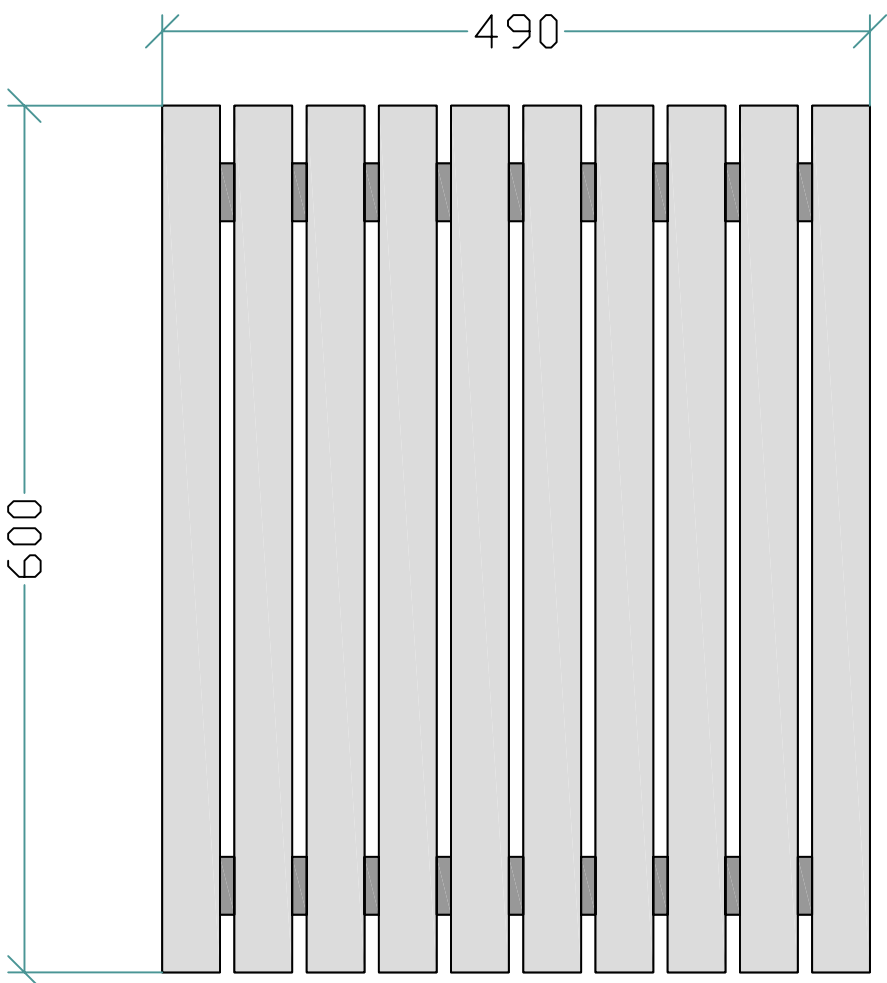
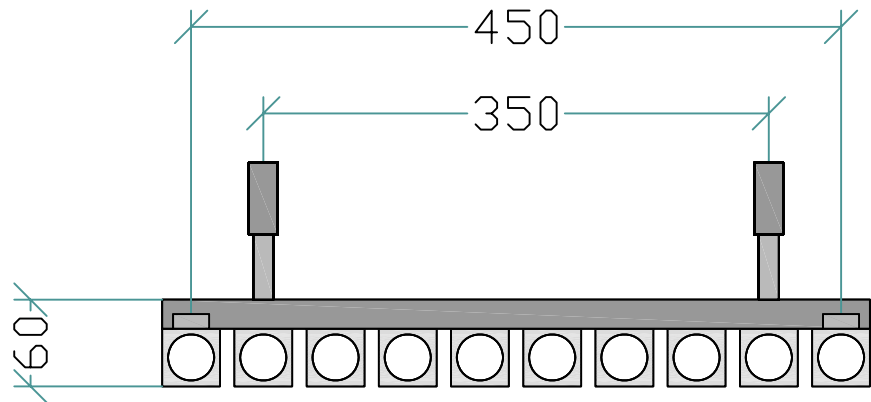

Watt	1.128
BTU	3.849
kcal / h	970

Elan 10-6060

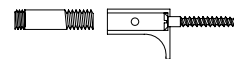
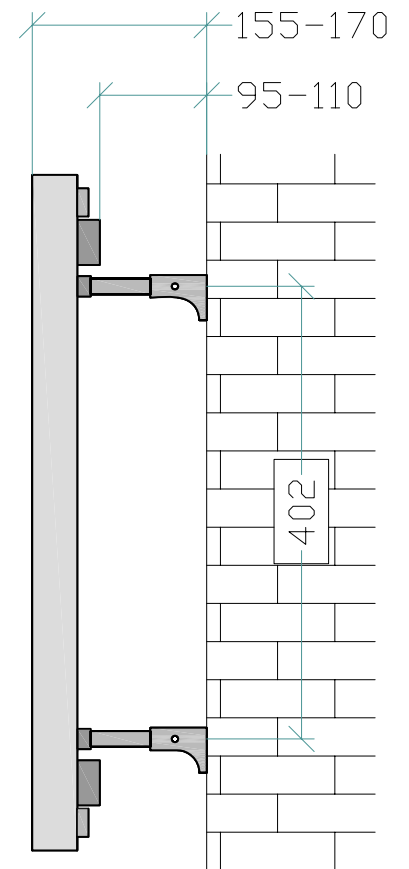
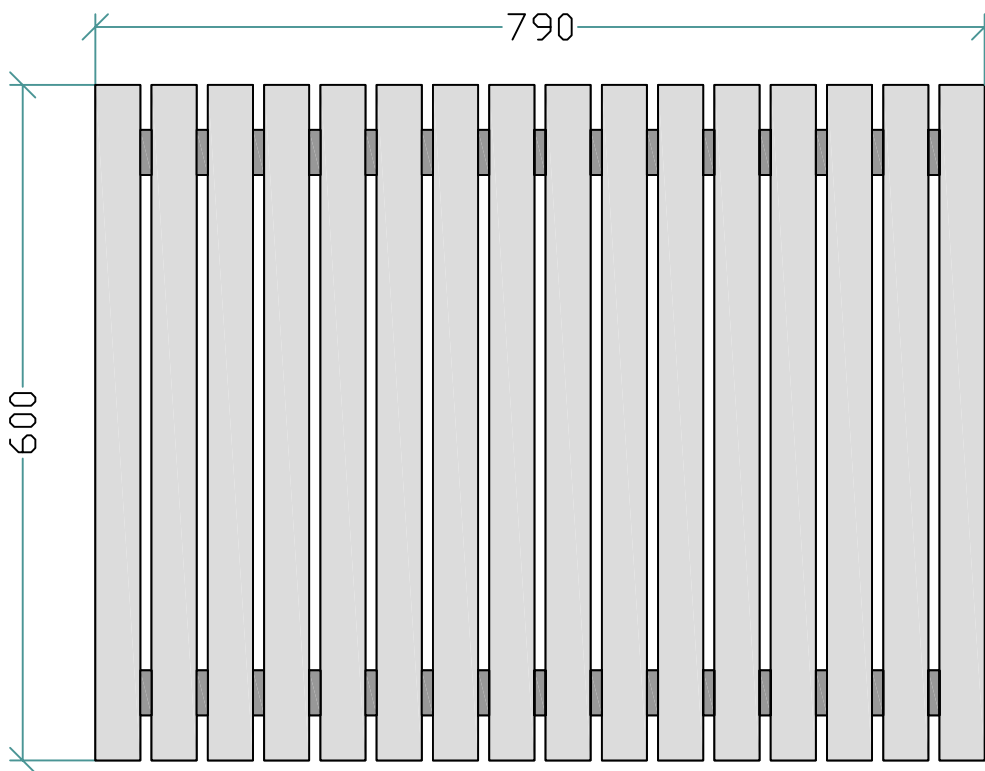
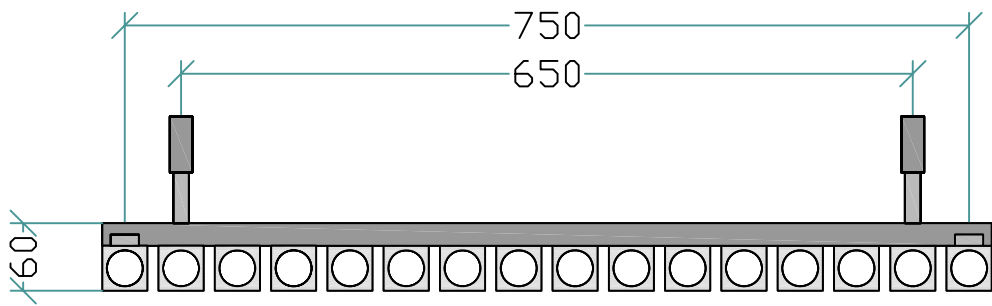

Watt	1.805
BTU	6.158
kcal / h	1.552

Elan 16-6060

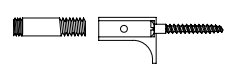
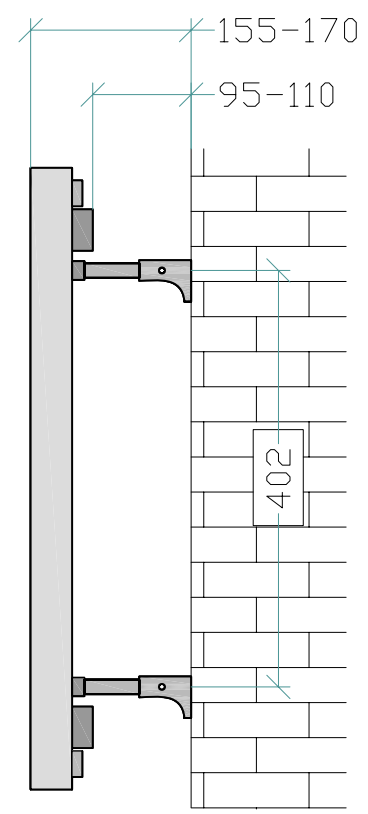
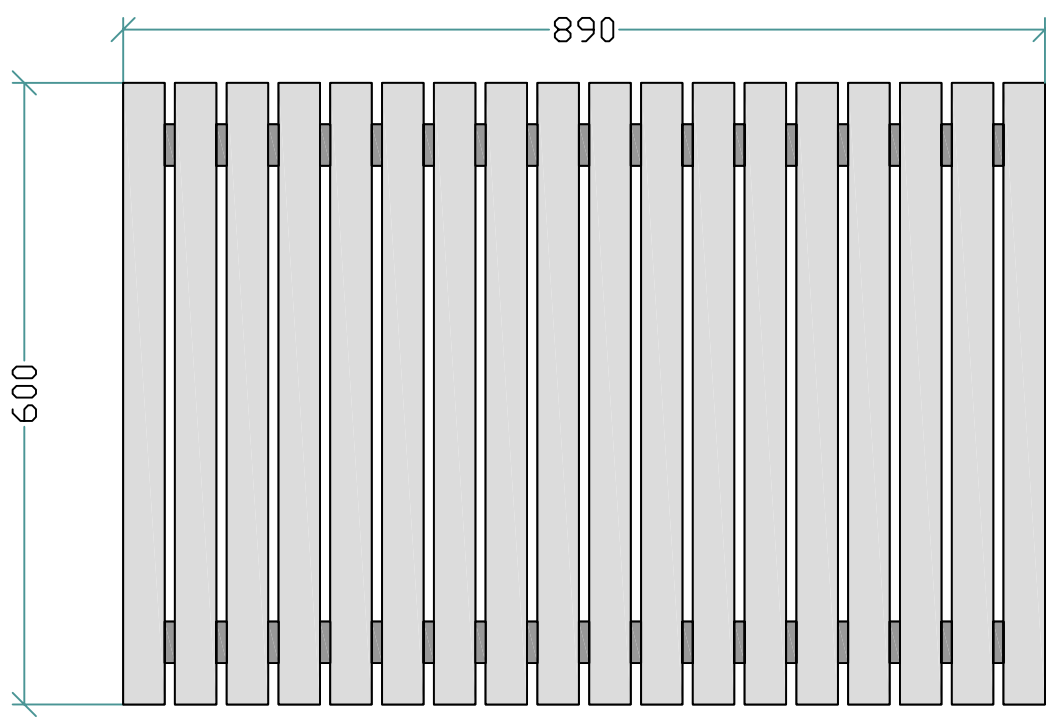
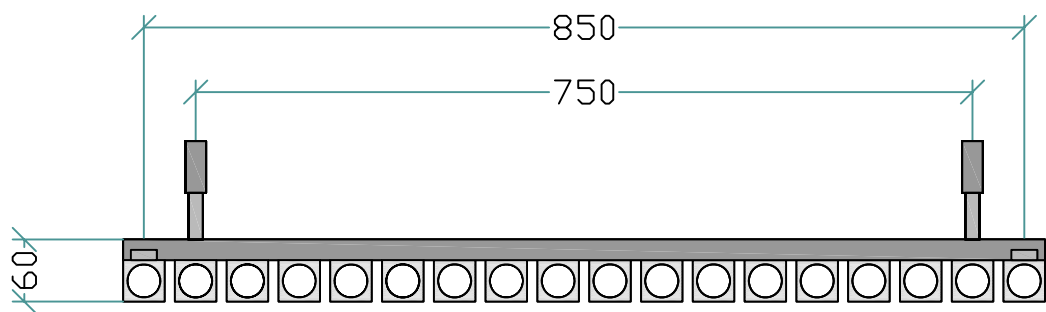

Watt	2.030
BTU	6.928
kcal / h	1.746

Elan 18-6060

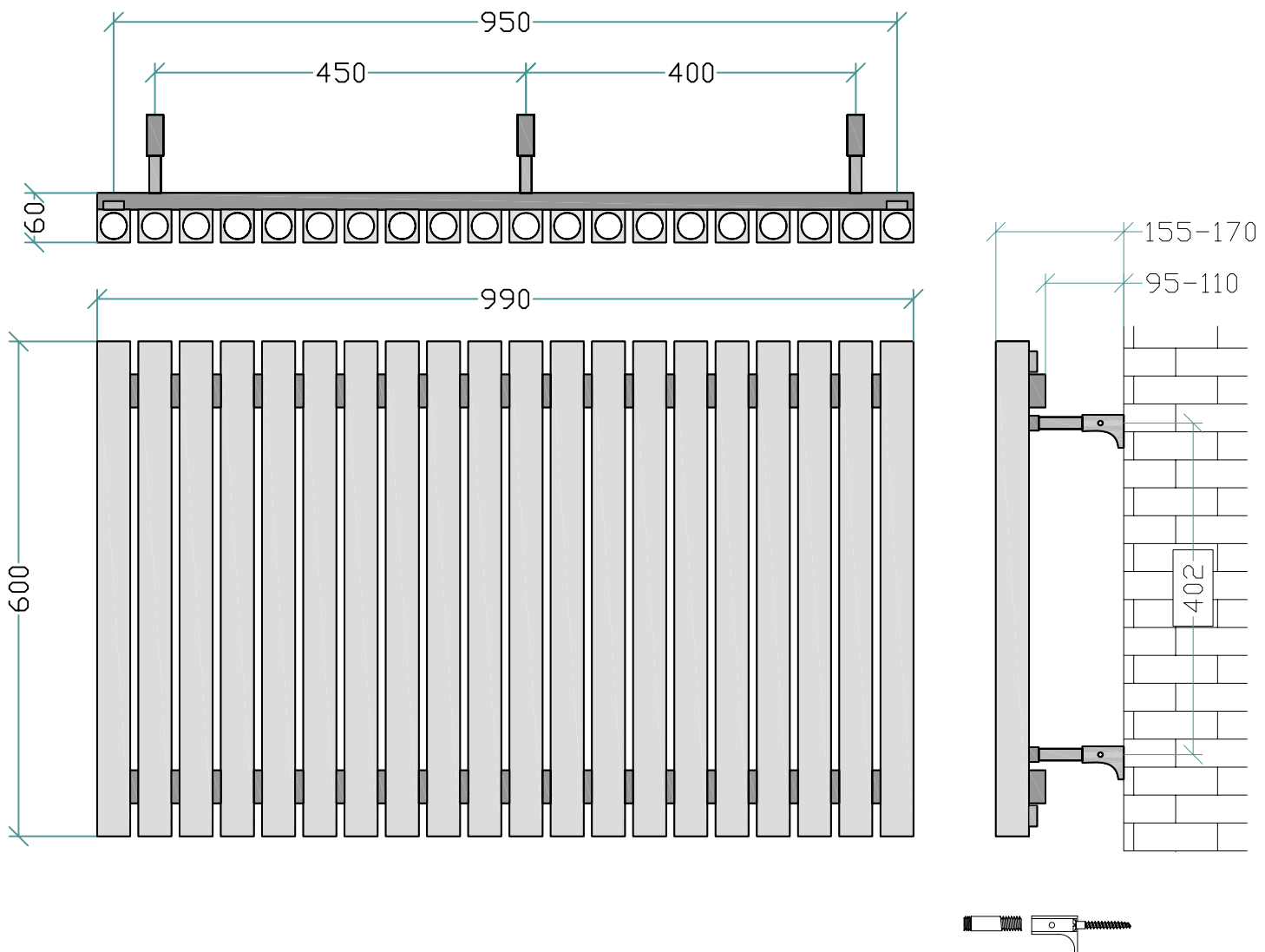

Watt	2.256
BTU	7.698
kcal / h	1.940

Elan 20-6060

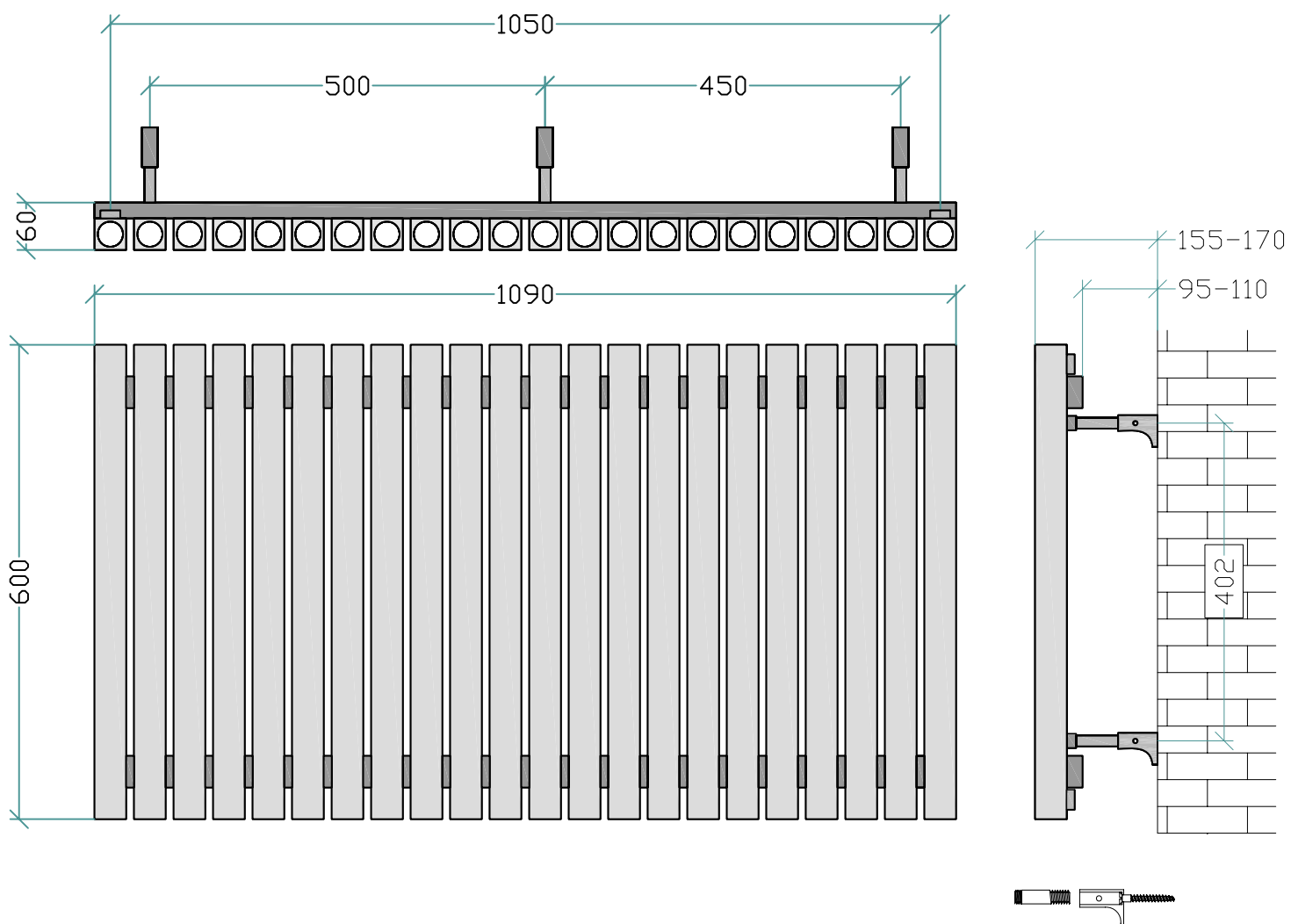

Watt	2.482
BTU	8.467
kcal / h	2.134

Elan 22-6060



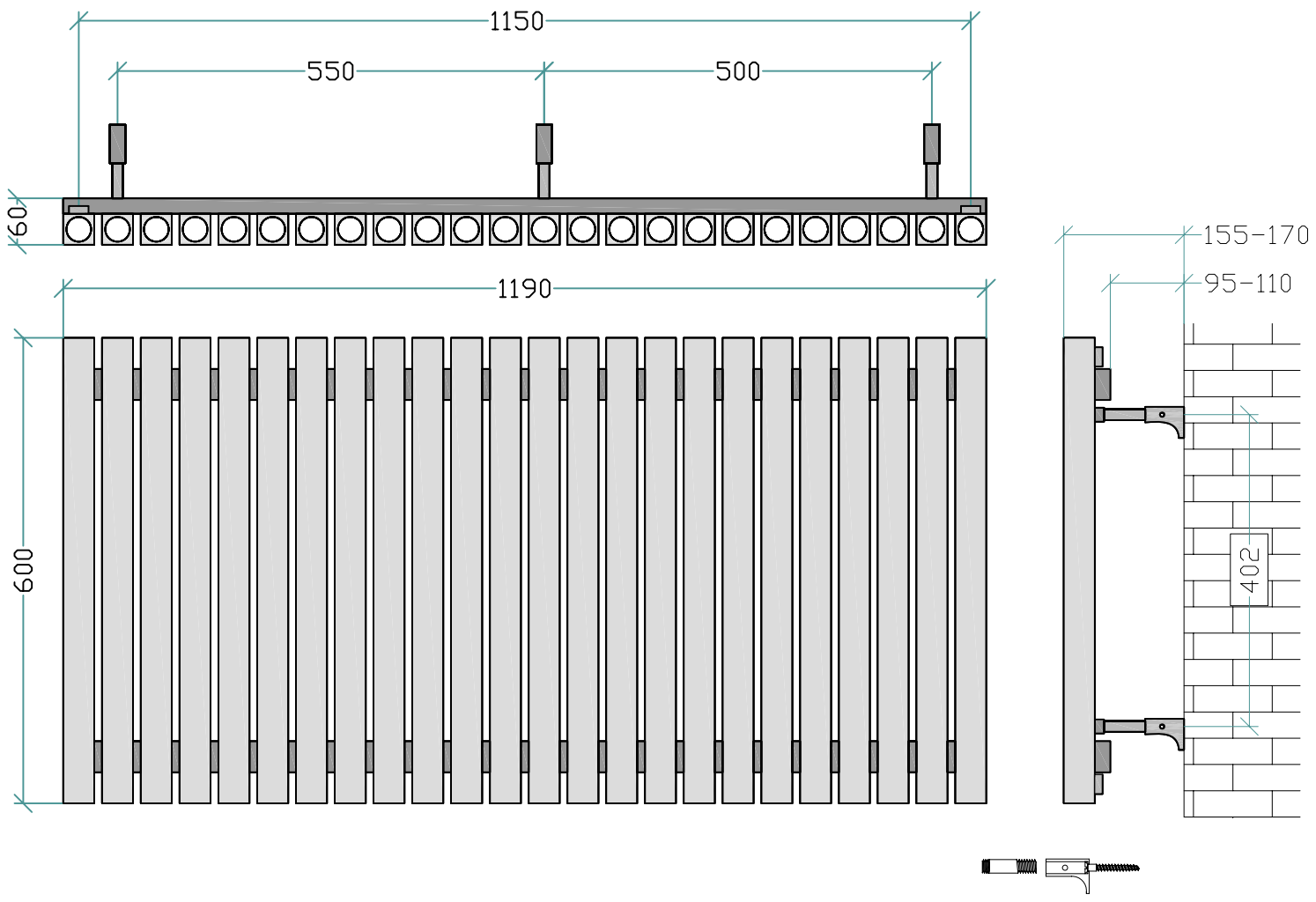

Watt	2.707
BTU	9.237
kcal / h	2.328

Elan 24-6060

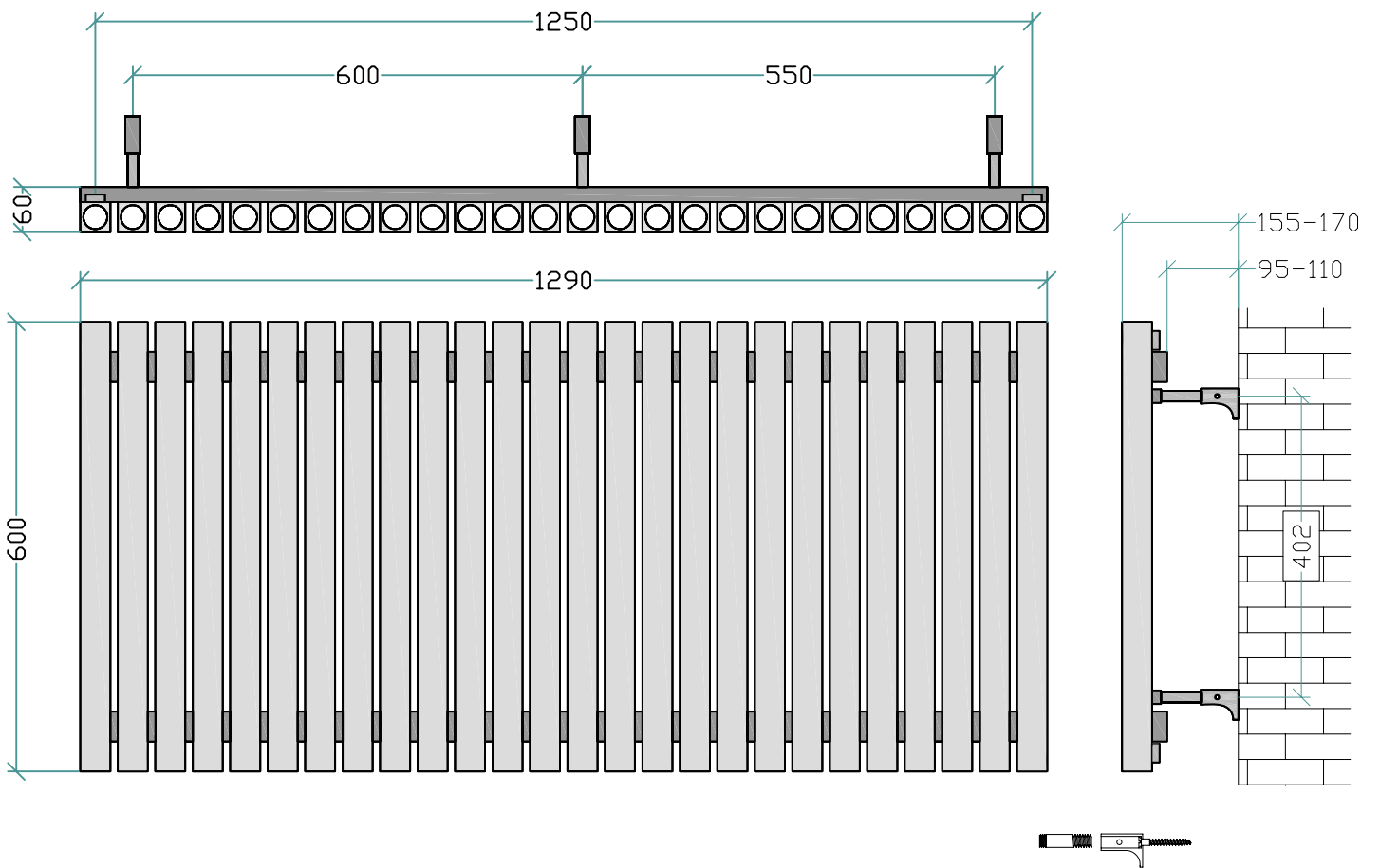

Watt	2.933
BTU	10.007
kcal / h	2.522

Elan 26-6060

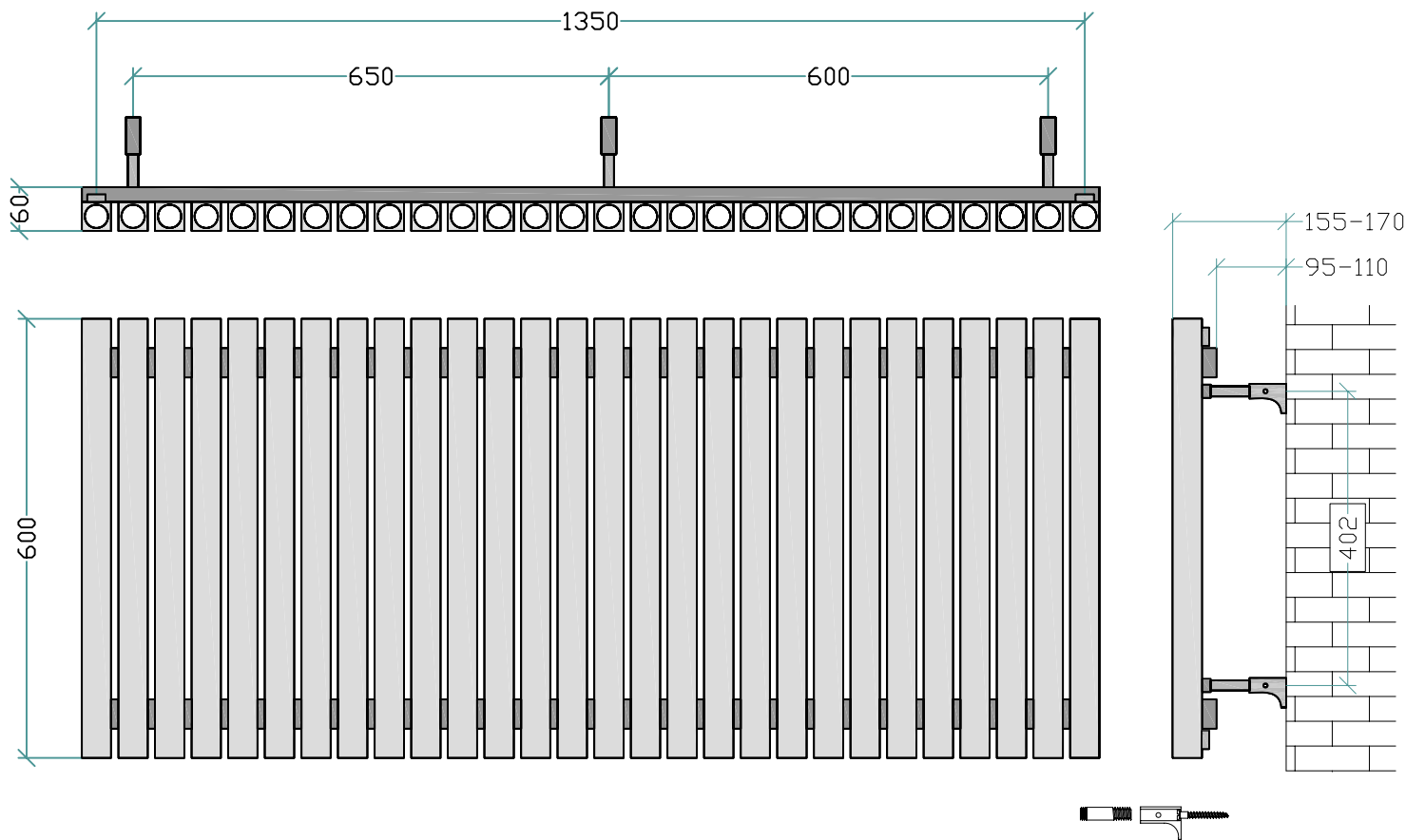

Watt	3.158
BTU	10.777
kcal / h	2.716

Elan 28-6060

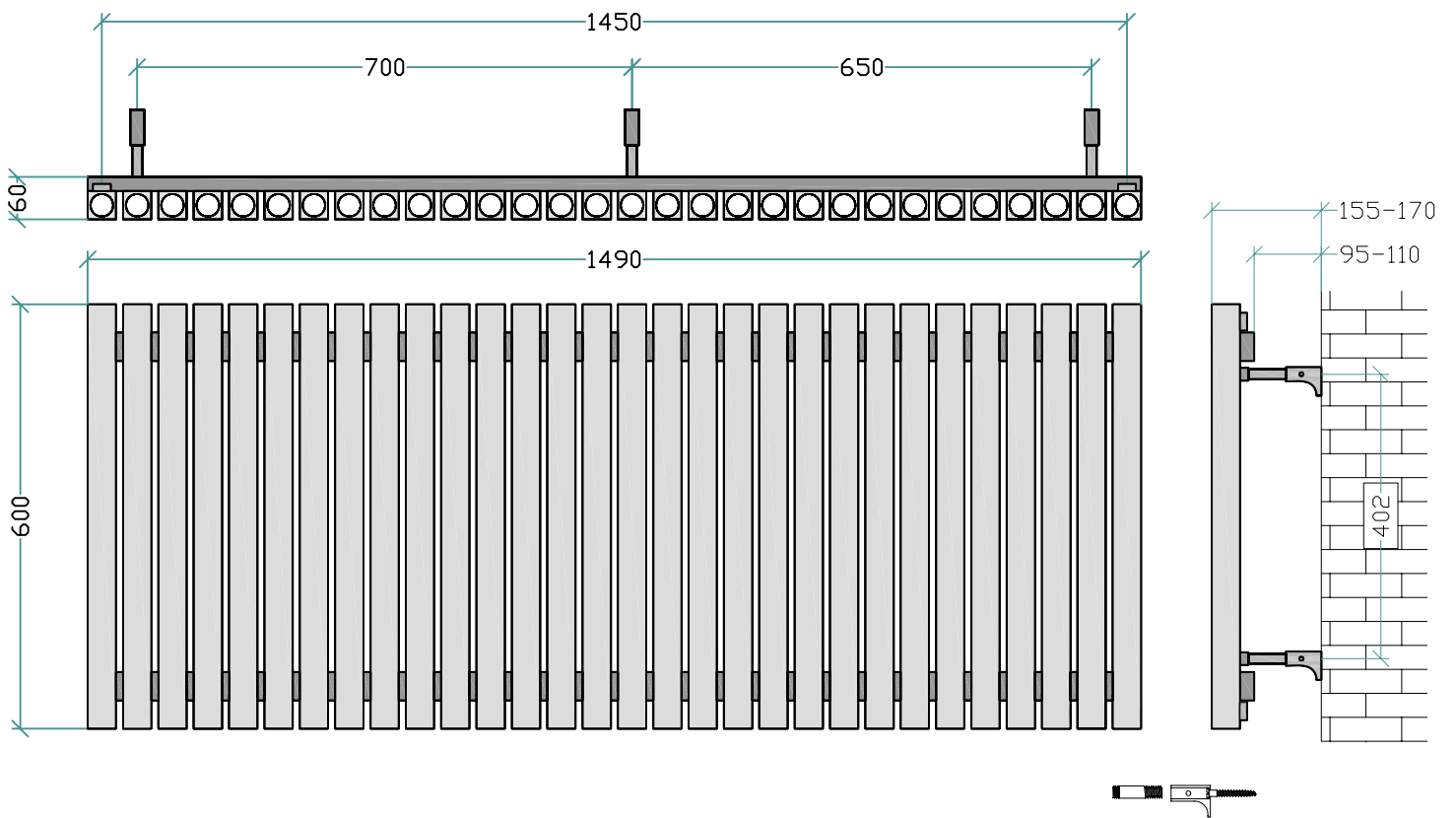

Watt	3.384
BTU	11.547
kcal / h	2.910

Elan 30-6060

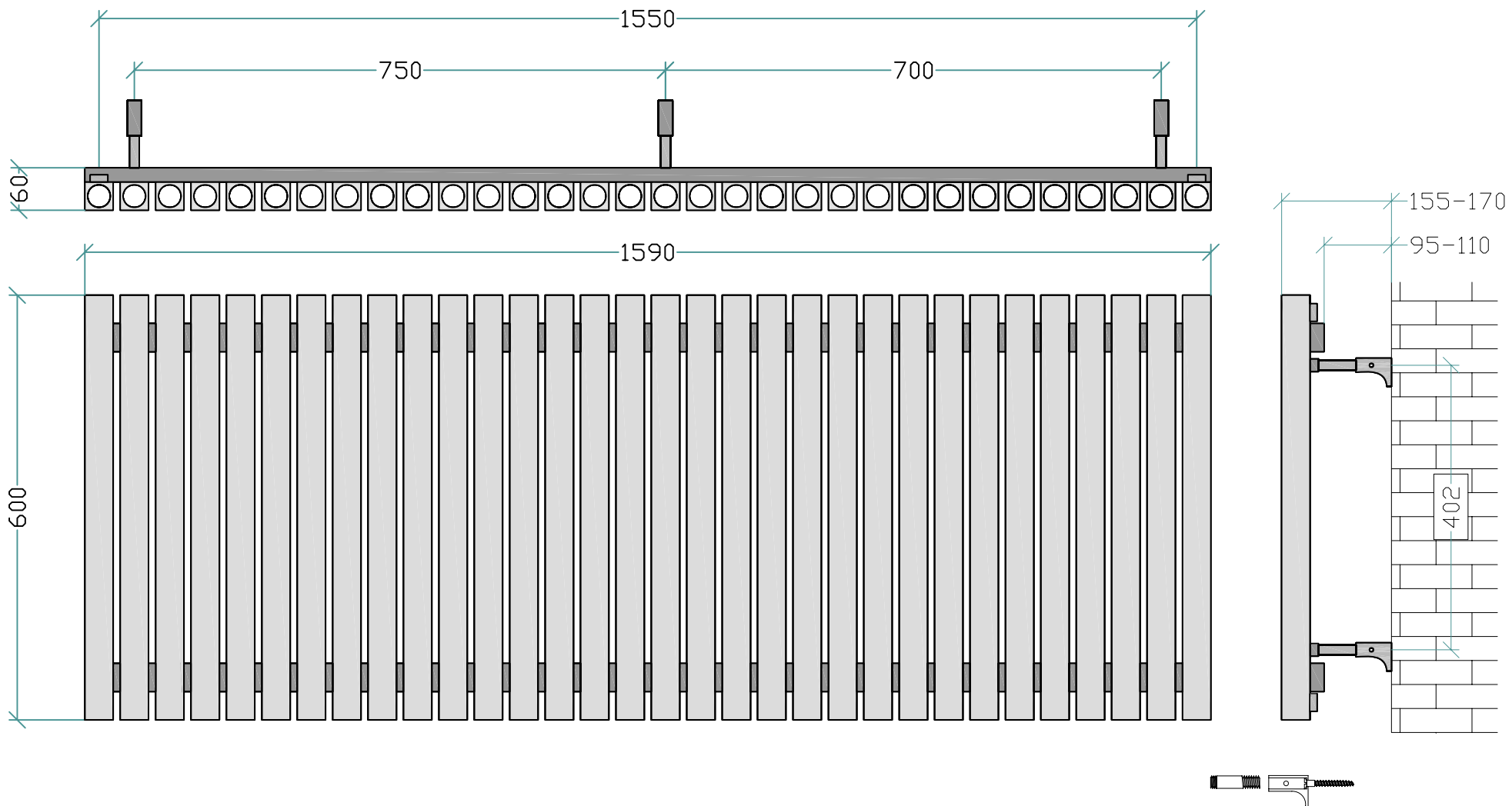

Watt	3.610
BTU	12.316
kcal / h	3.104

Elan 32-6060

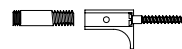
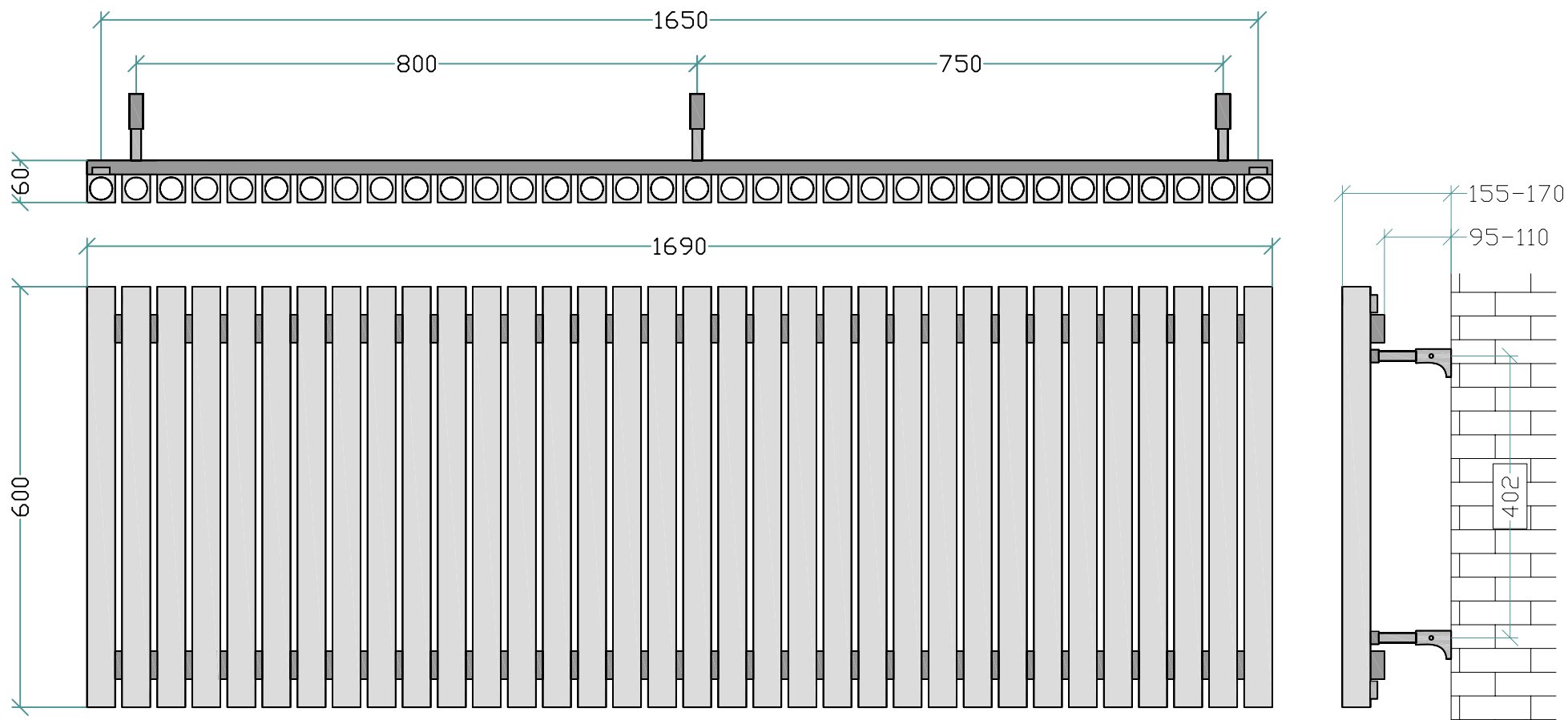

Watt	3.835
BTU	13.086
kcal / h	3.298

Elan 34-6060

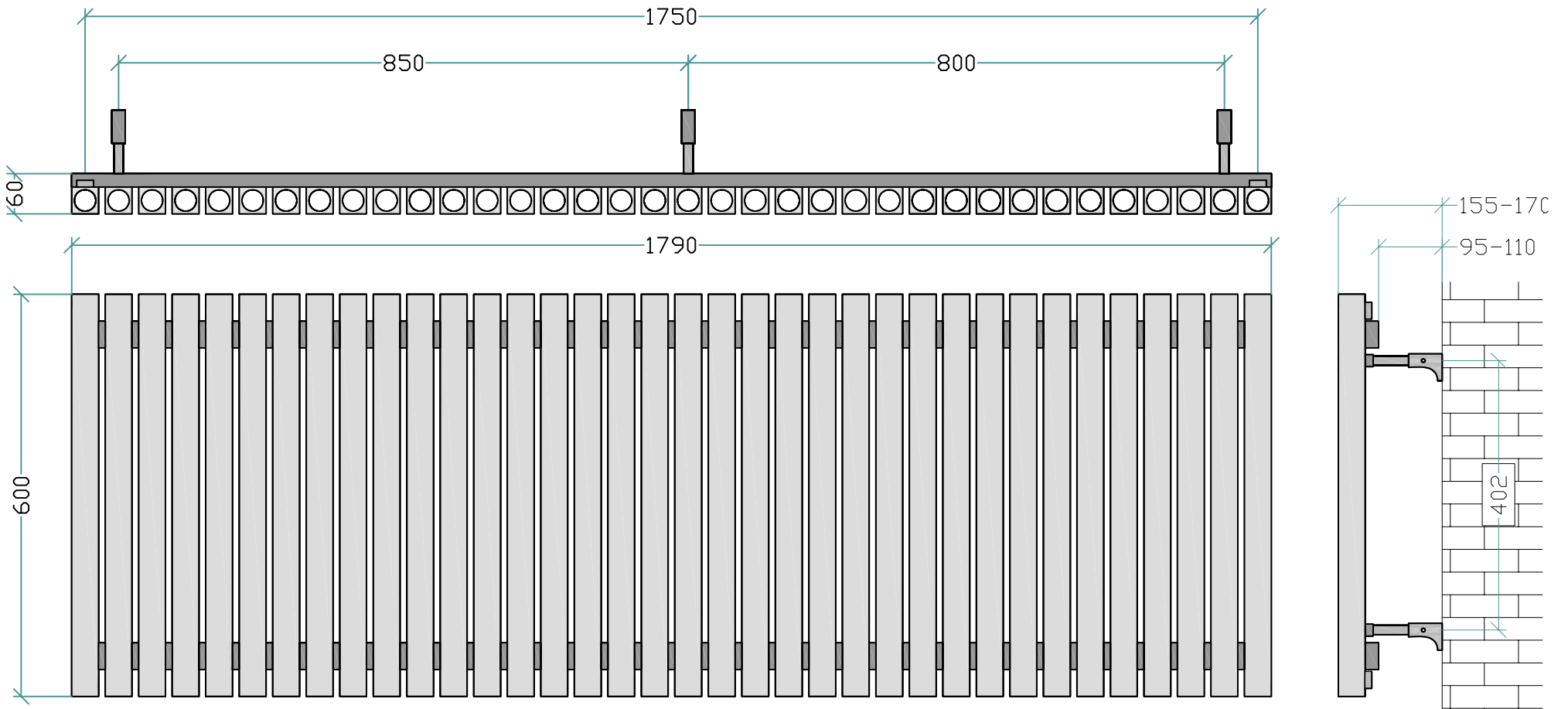

Watt	4.061
BTU	13.856
kcal / h	3.491

**Elan 36-6060**