

| | |
|----------|-----|
| Watt | 230 |
| BTU | 786 |
| kcal / h | 198 |

Polo 04746-8

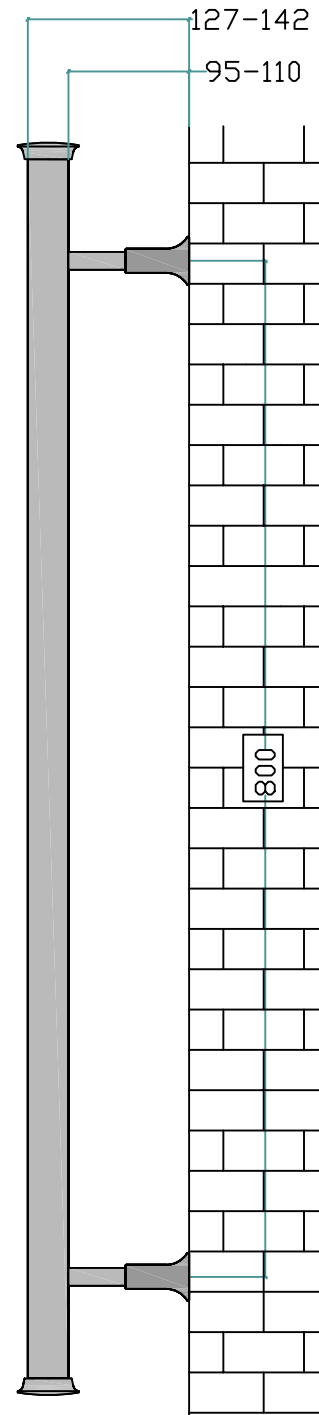

| | |
|----------|-------|
| Watt | 540 |
| BTU | 1.843 |
| kcal / h | 464 |

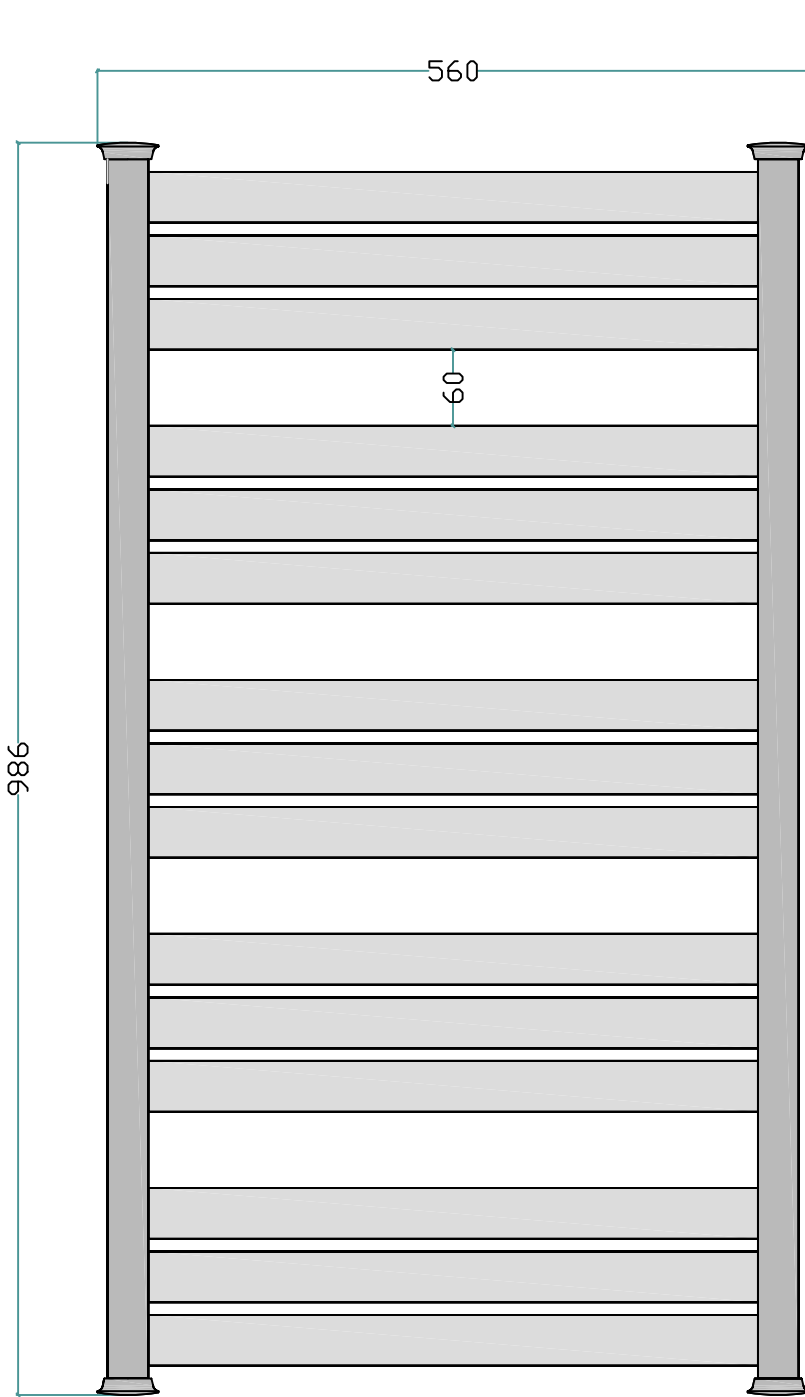
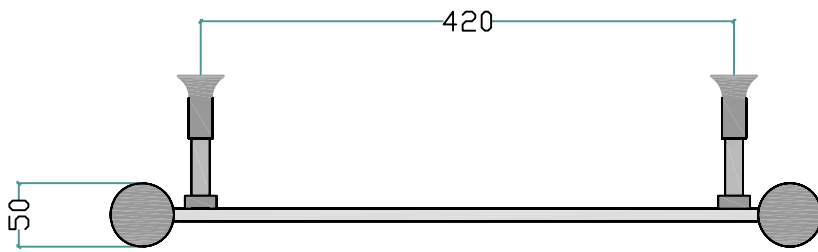
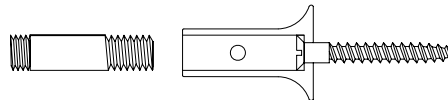

Polo 09656-15

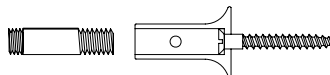
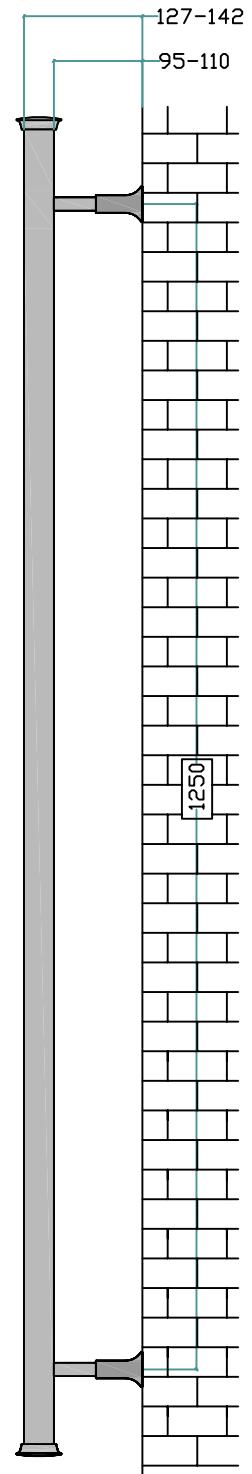
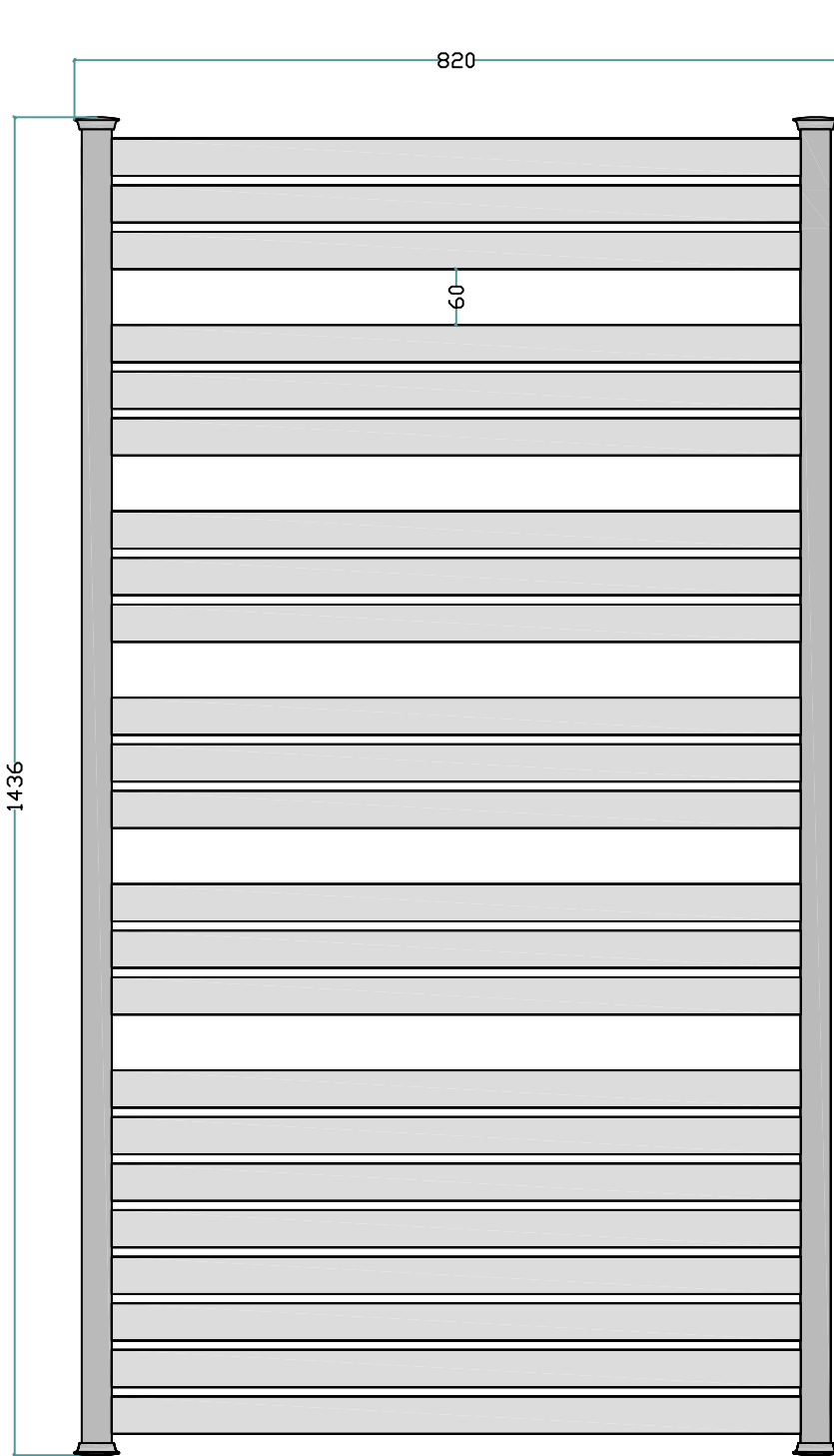
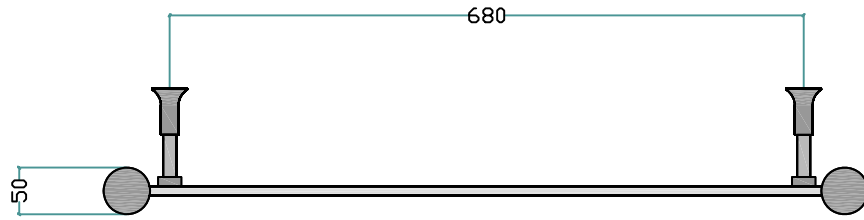

| | |
|----------|-------|
| Watt | 1.242 |
| BTU | 4.238 |
| kcal / h | 1.068 |

Polo 15082-23

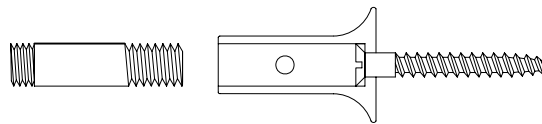
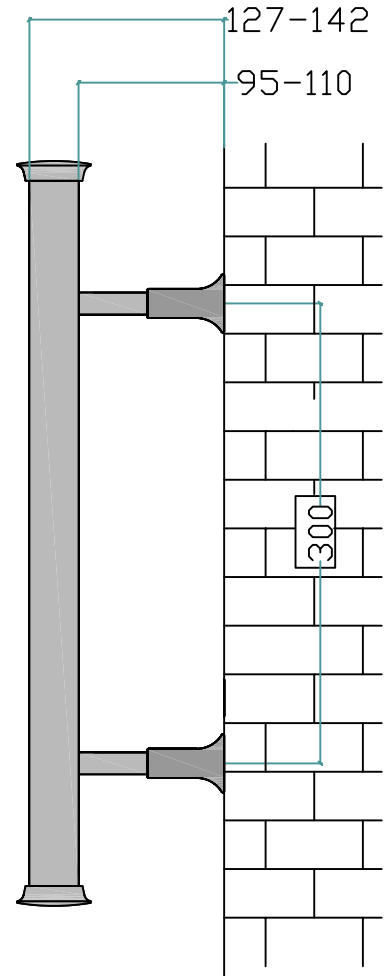
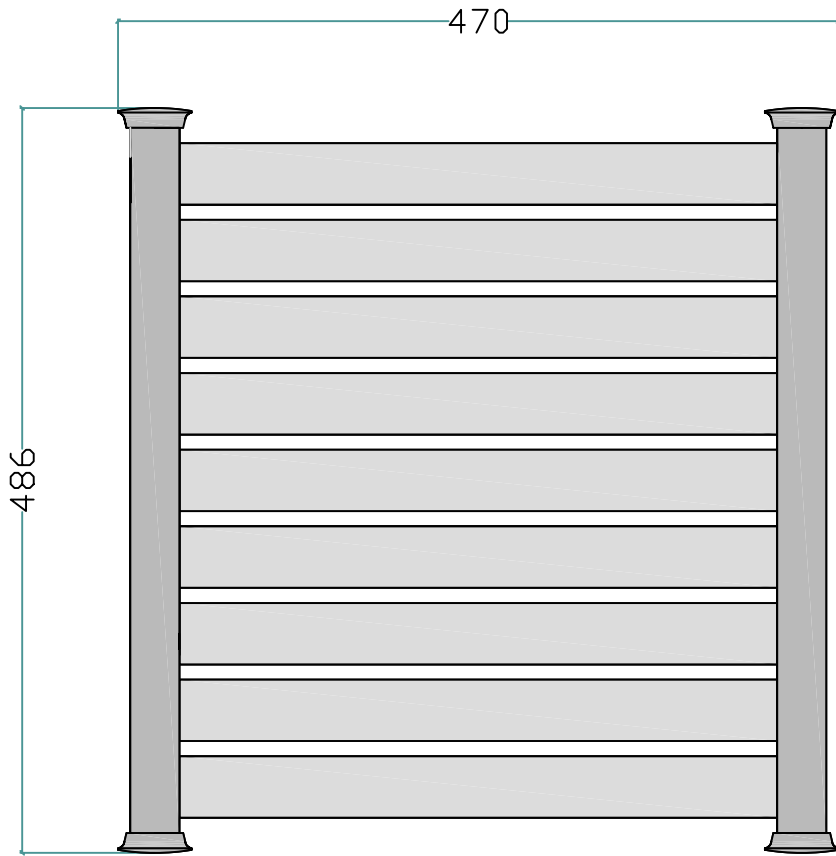
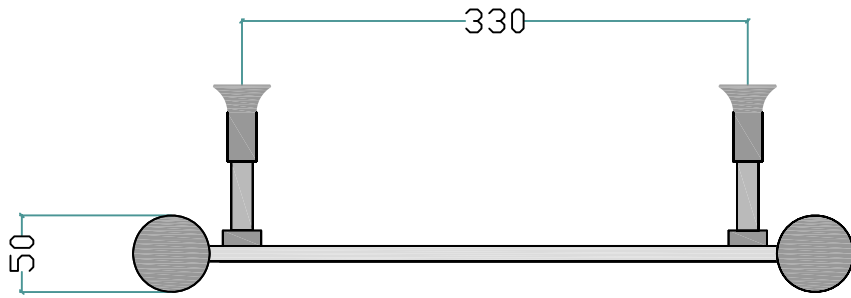

| | |
|----------|-----|
| Watt | 259 |
| BTU | 884 |
| kcal / h | 223 |

Polo 04746-9

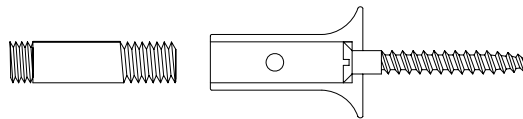
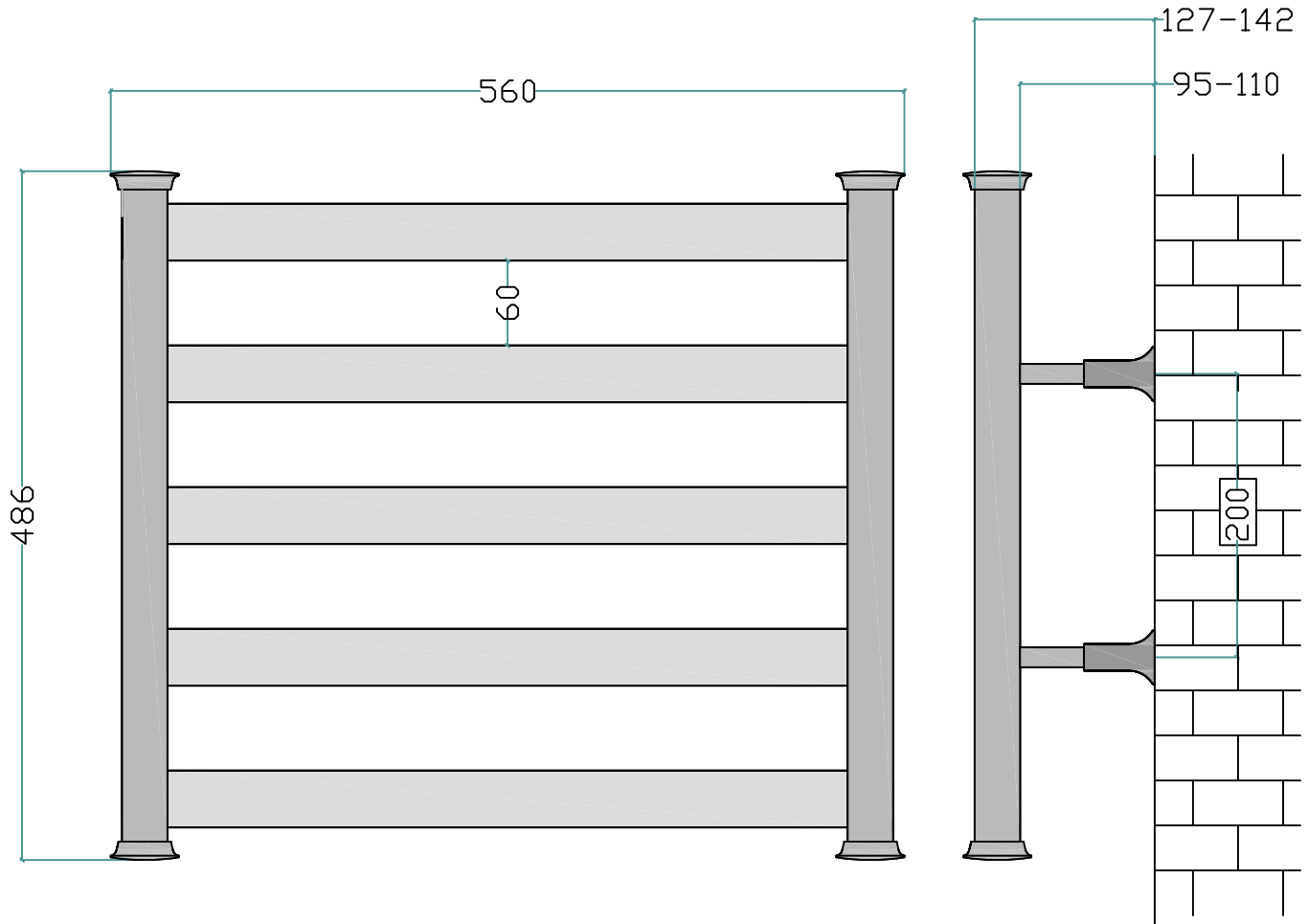
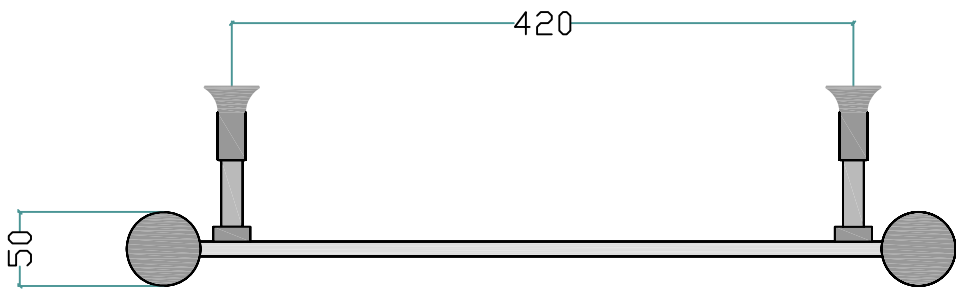

| | |
|----------|-----|
| Watt | 180 |
| BTU | 614 |
| kcal / h | 155 |

Polo 04756-5

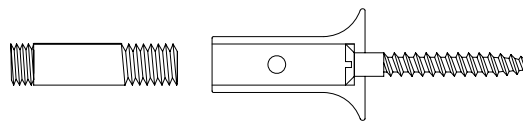
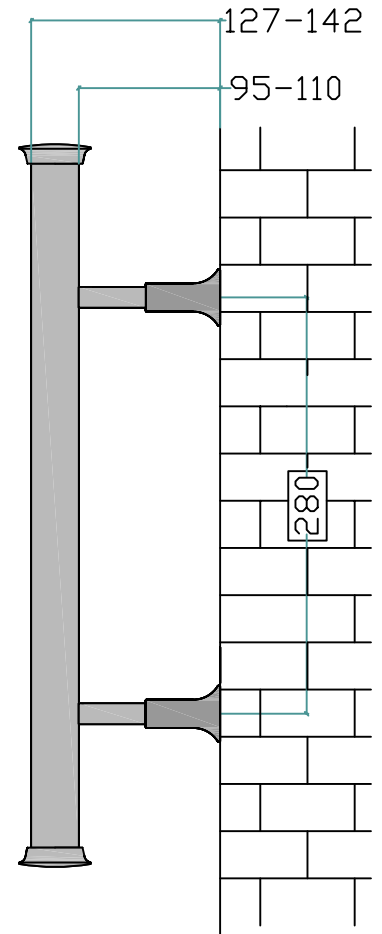
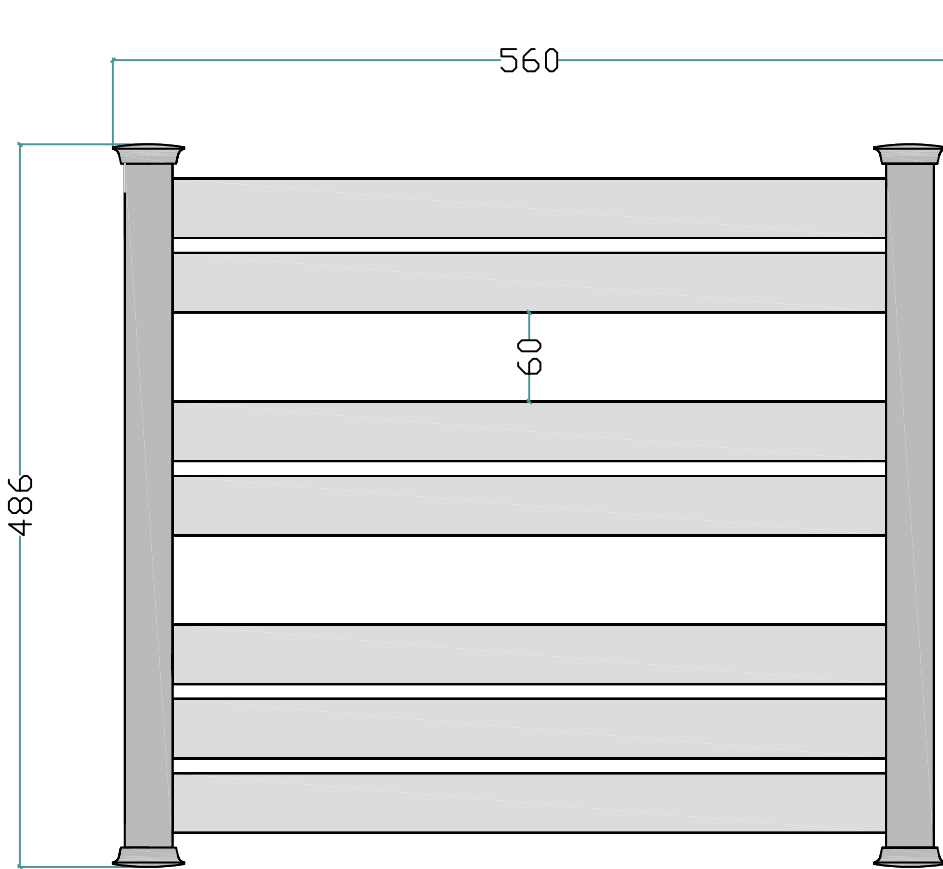
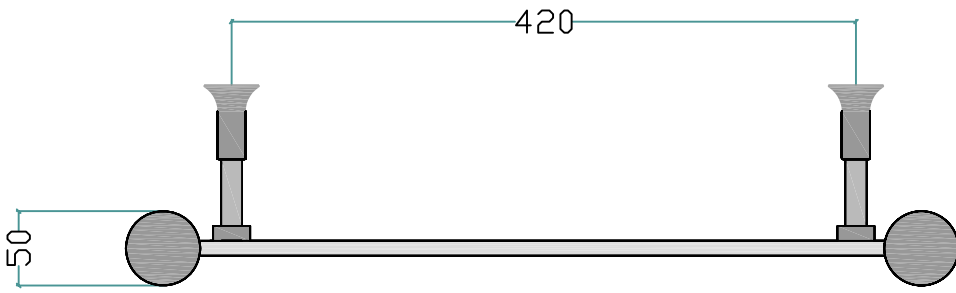

| | |
|----------|-----|
| Watt | 252 |
| BTU | 860 |
| kcal / h | 217 |

Polo 04756-7

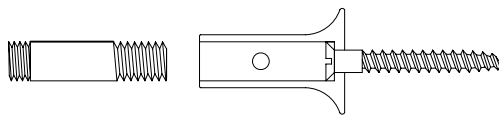
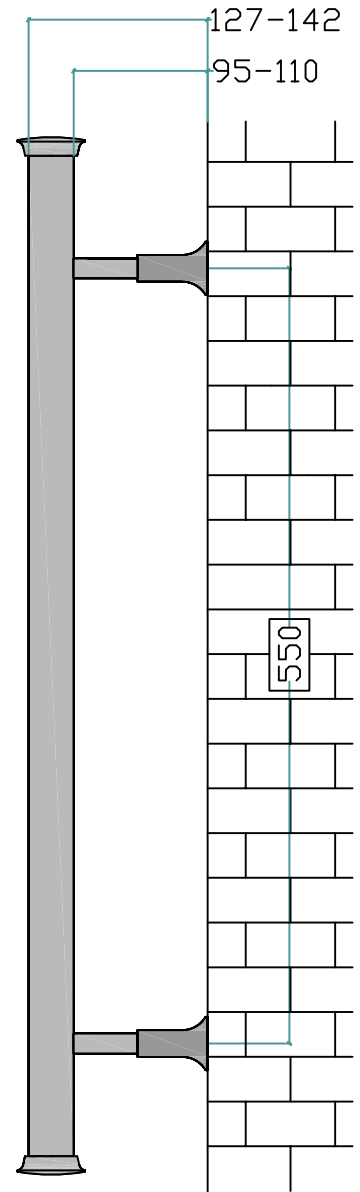
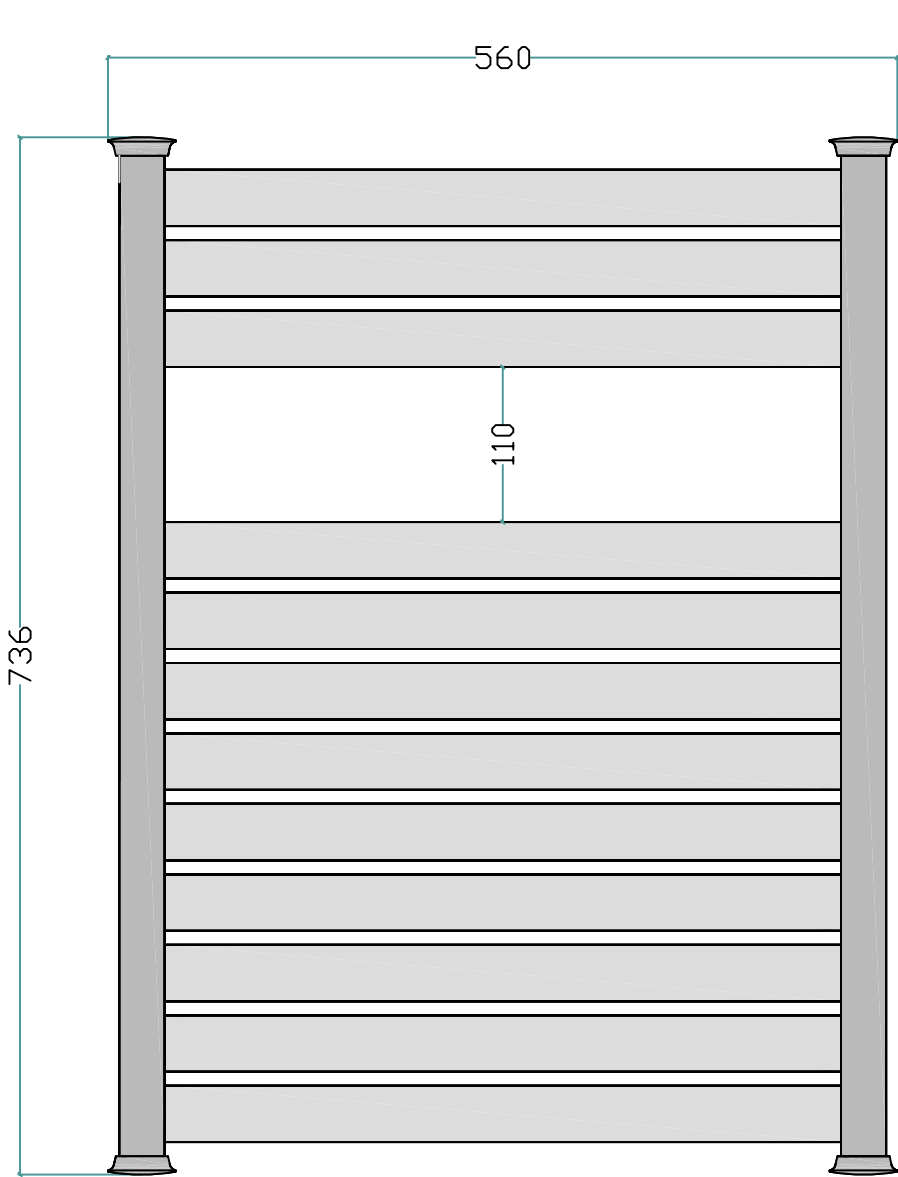
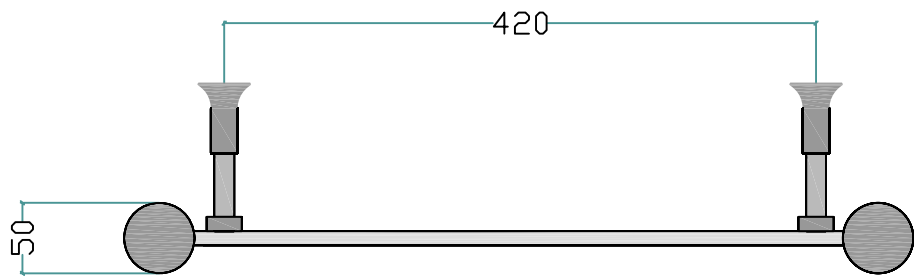

| | |
|----------|-------|
| Watt | 432 |
| BTU | 1.474 |
| kcal / h | 371 |

Polo 07556-12

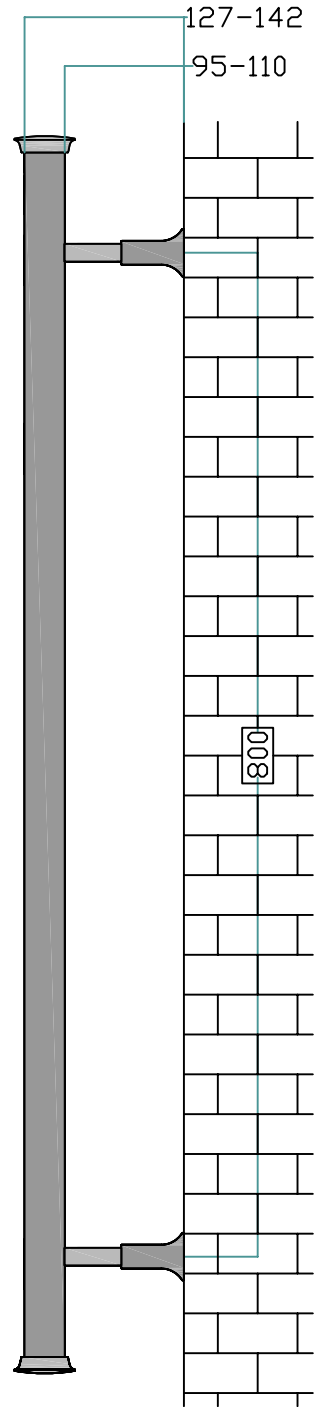
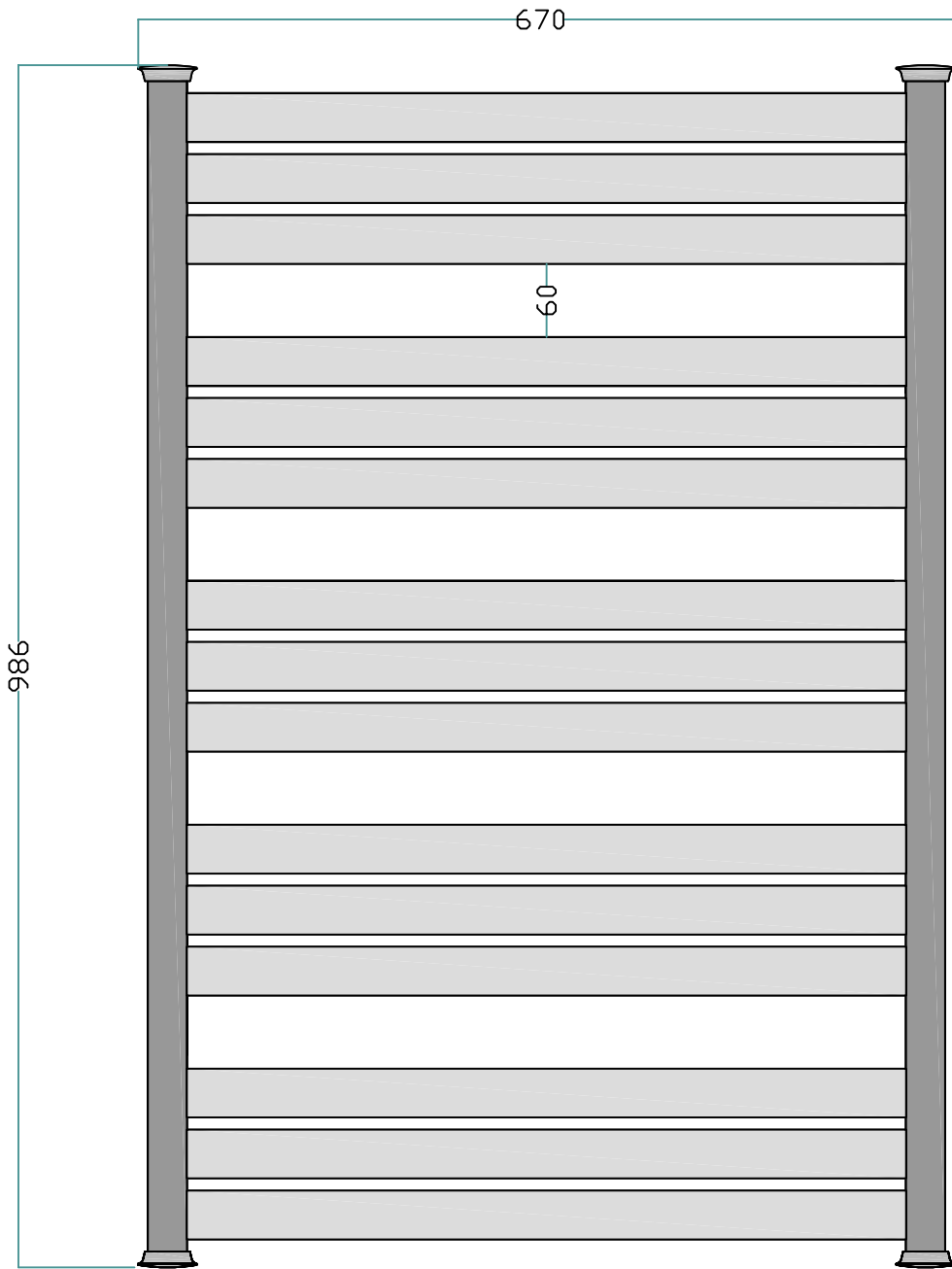
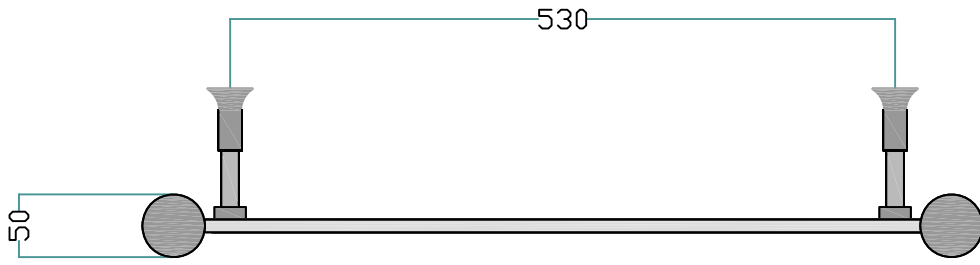

| | |
|----------|-------|
| Watt | 648 |
| BTU | 2.211 |
| kcal / h | 557 |

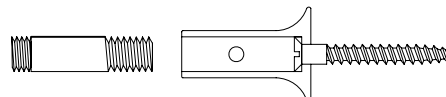

Polo 09666-15

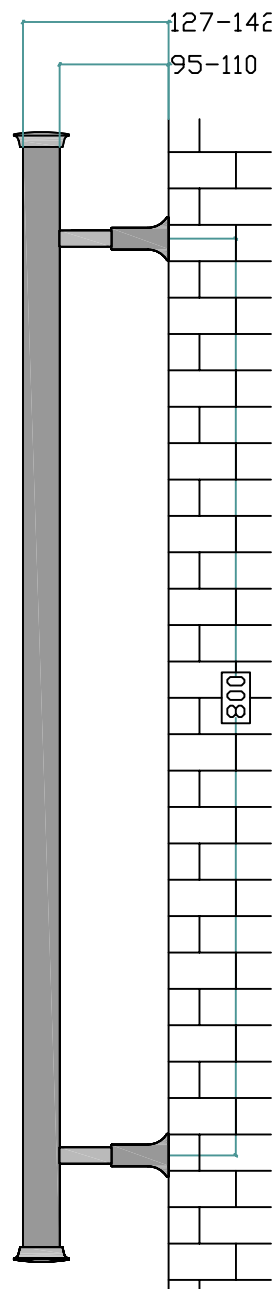
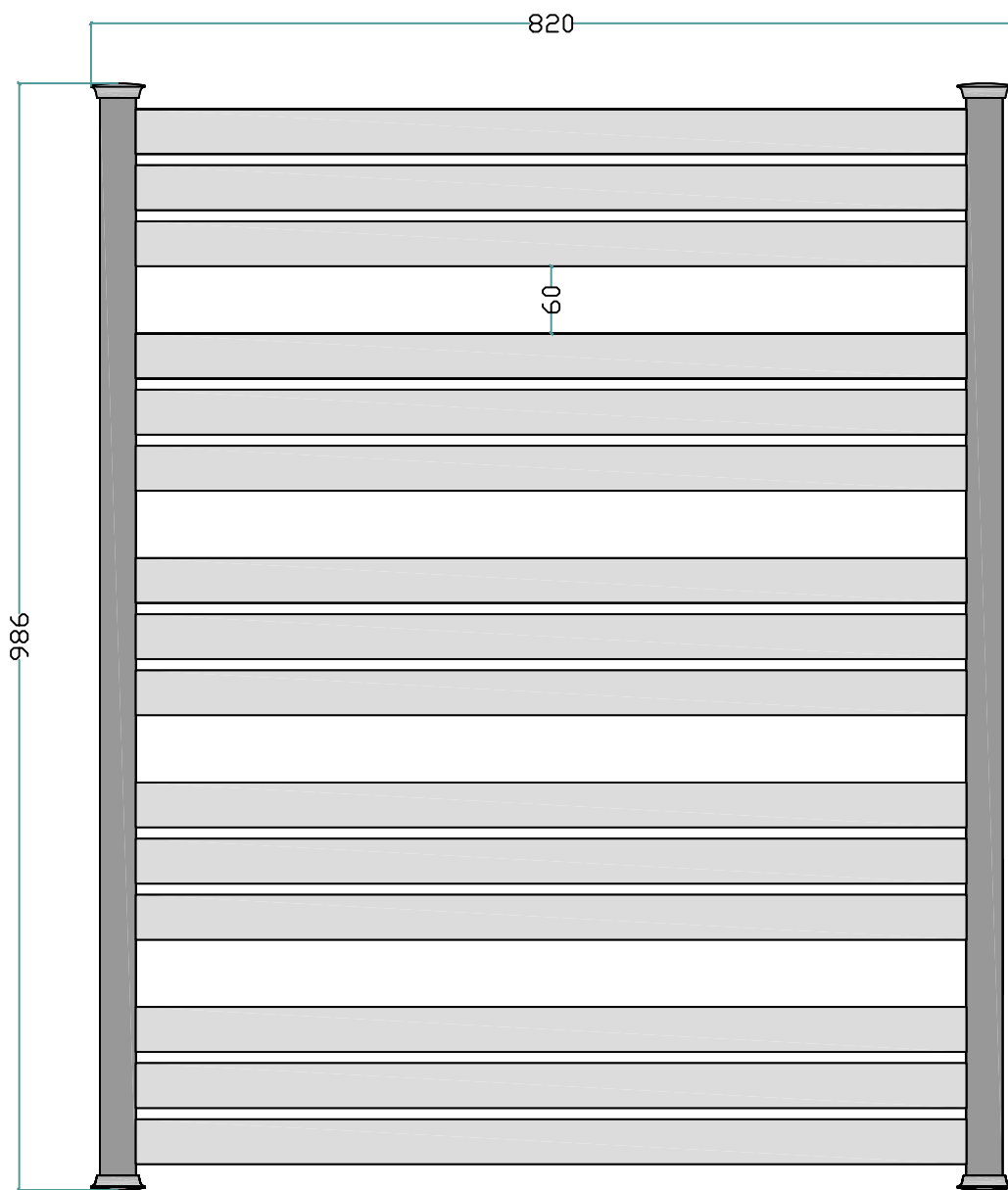
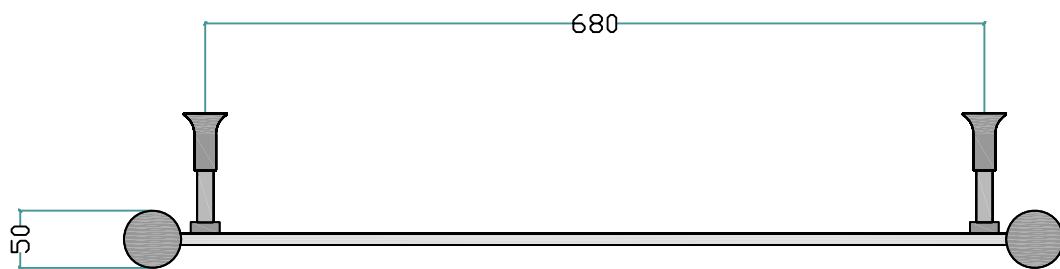

| | |
|----------|-------|
| Watt | 810 |
| BTU | 2.764 |
| kcal / h | 696 |

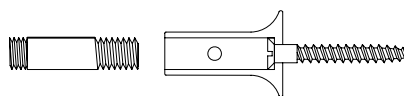

Polo 09682-15

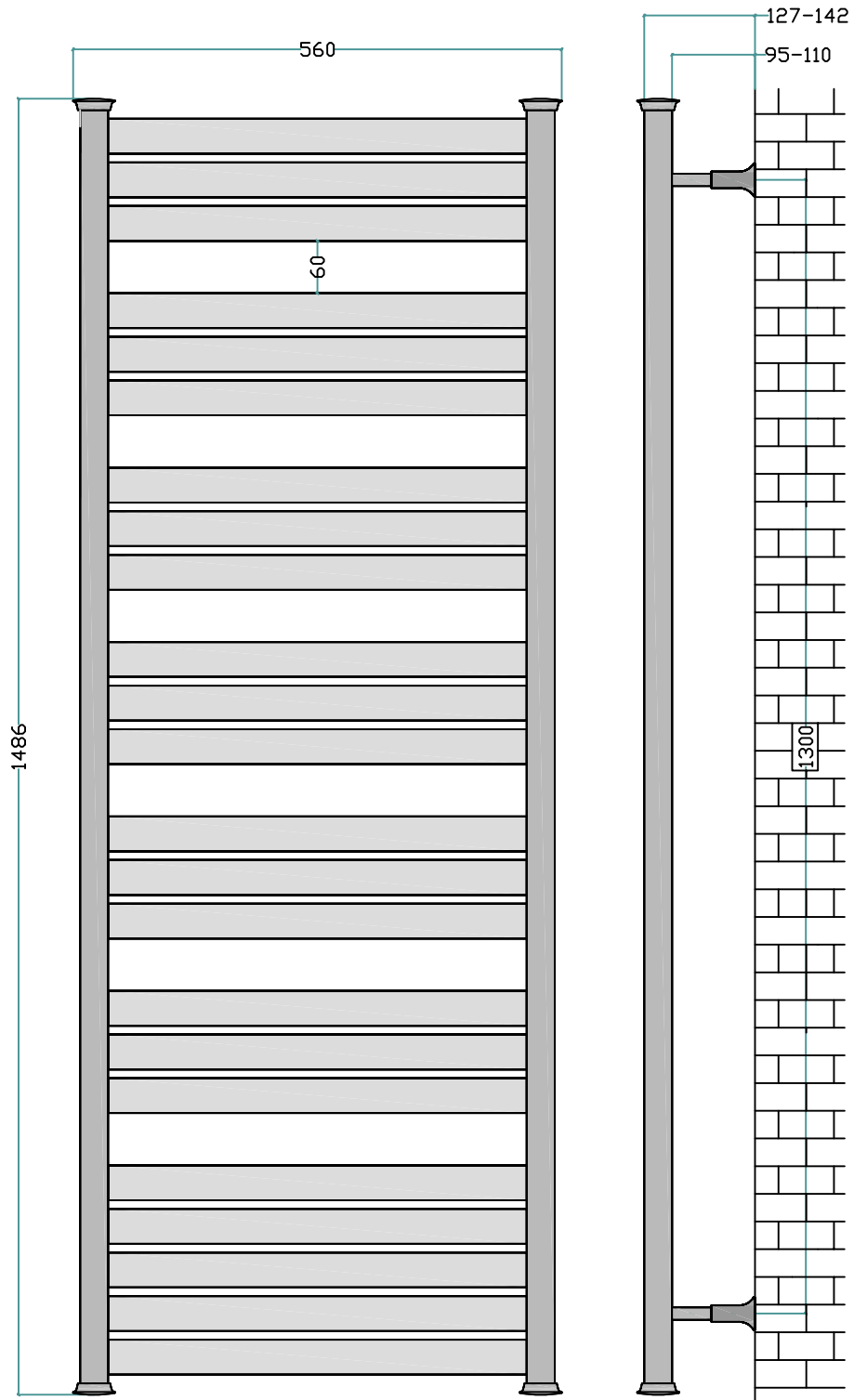
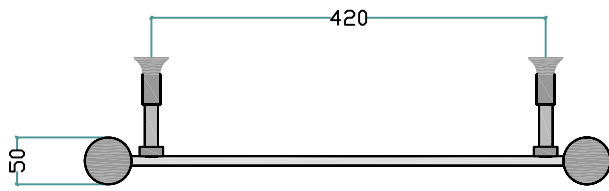

| | |
|----------|-------|
| Watt | 828 |
| BTU | 2.825 |
| kcal / h | 712 |

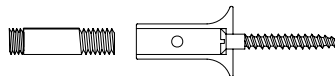

Polo 15056-23

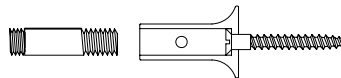
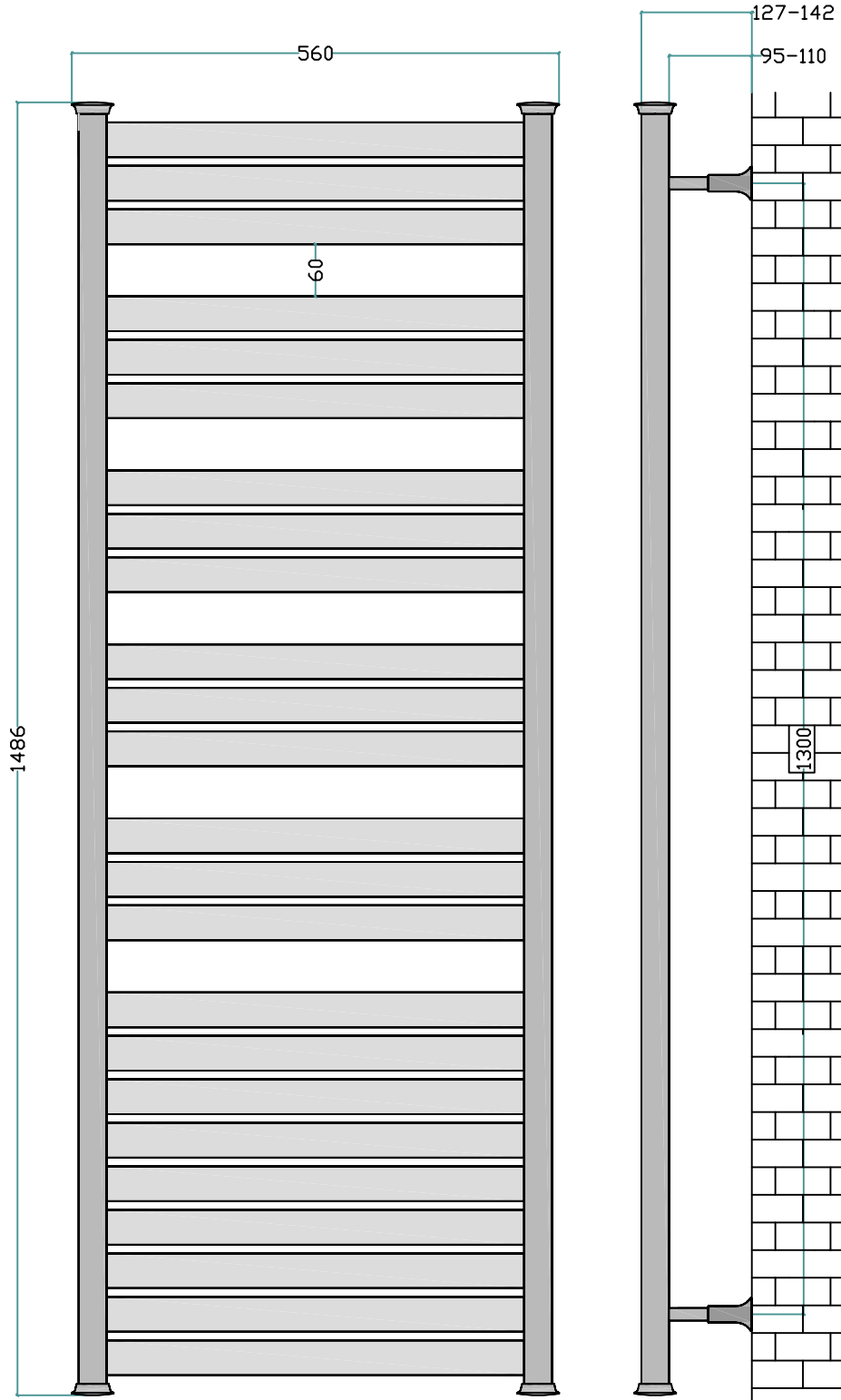
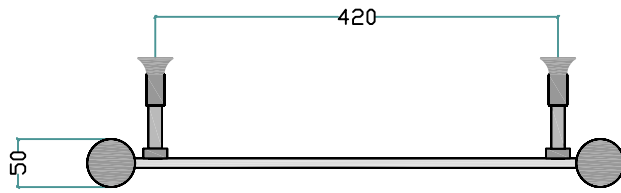

| | |
|----------|-------|
| Watt | 864 |
| BTU | 2.948 |
| kcal / h | 743 |

Polo 15056-24

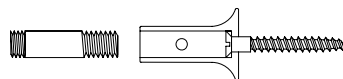
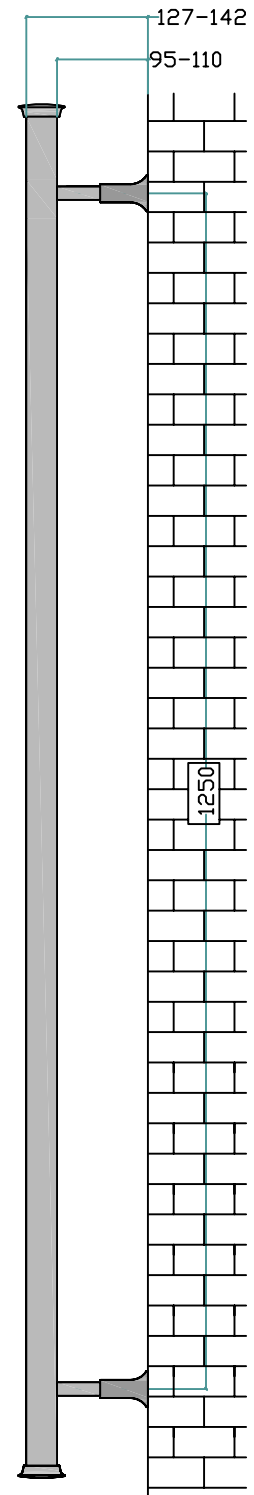
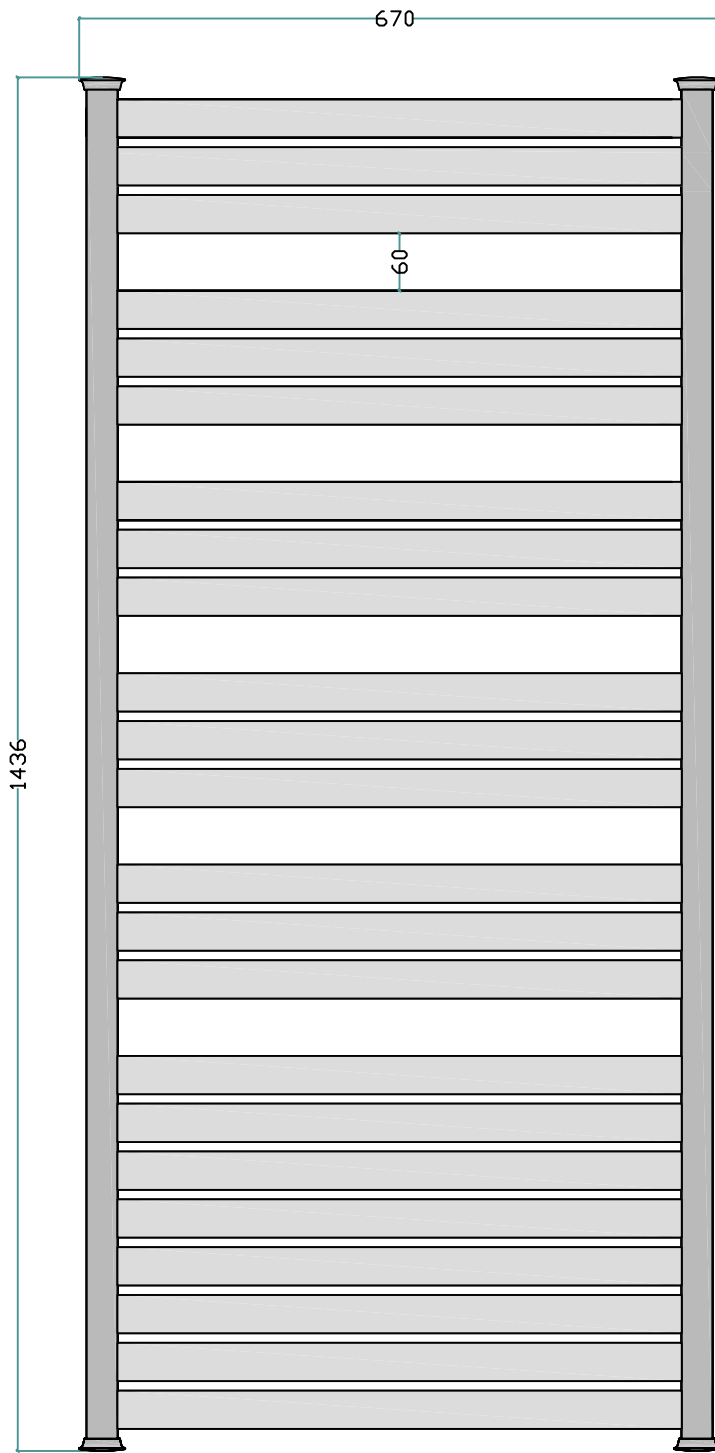
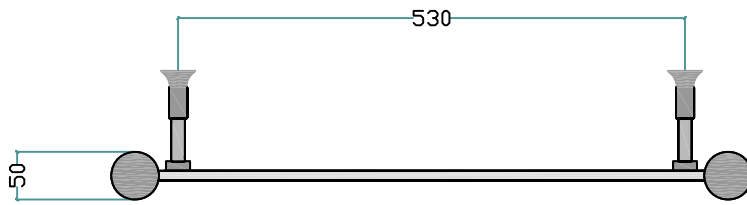

| | |
|----------|-------|
| Watt | 994 |
| BTU | 3.390 |
| kcal / h | 854 |

Polo 15066-23

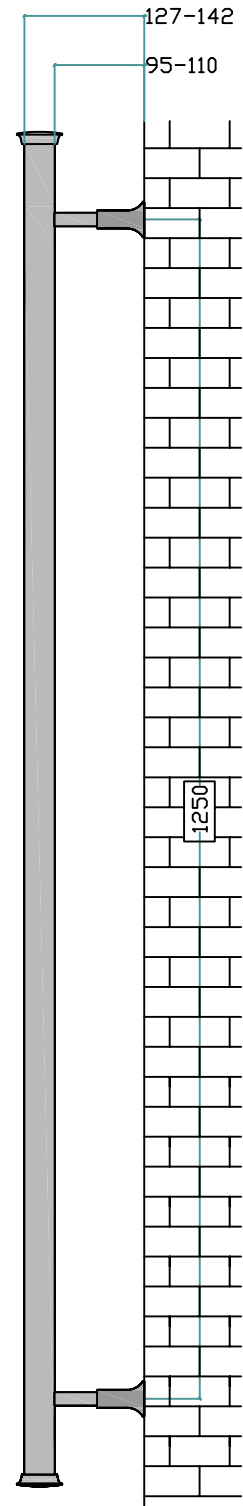
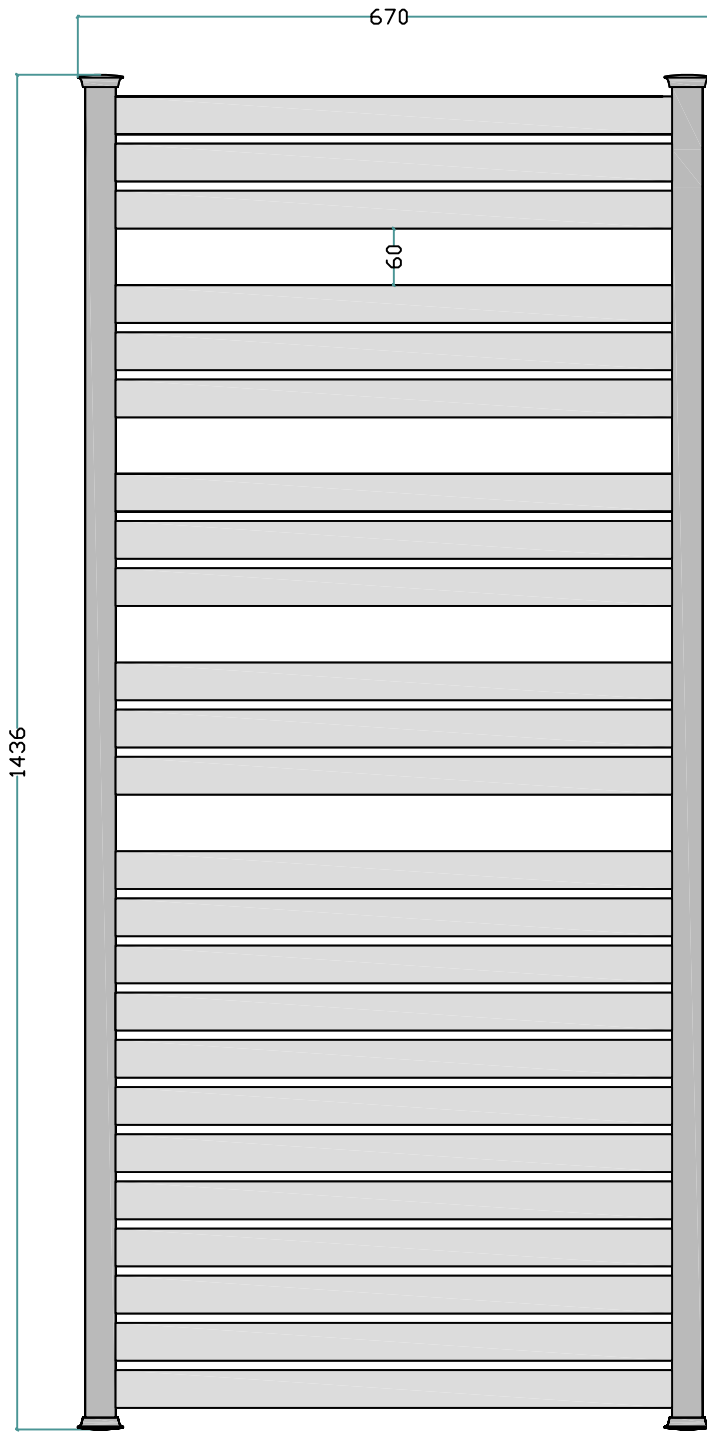
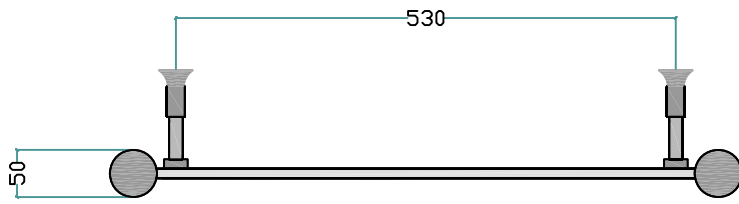

| | |
|----------|-------|
| Watt | 1.037 |
| BTU | 3.538 |
| kcal / h | 891 |

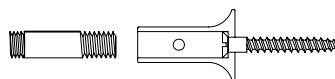

Polo 15066-24

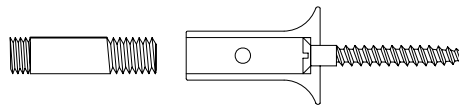
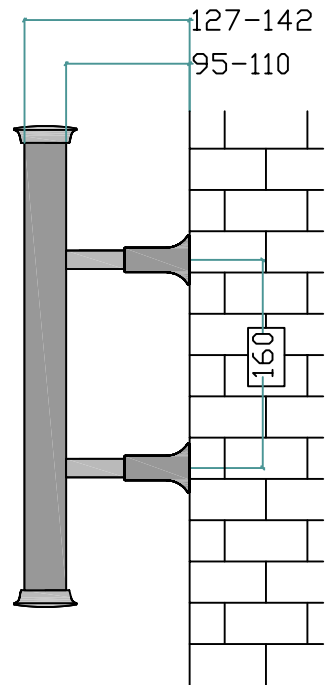
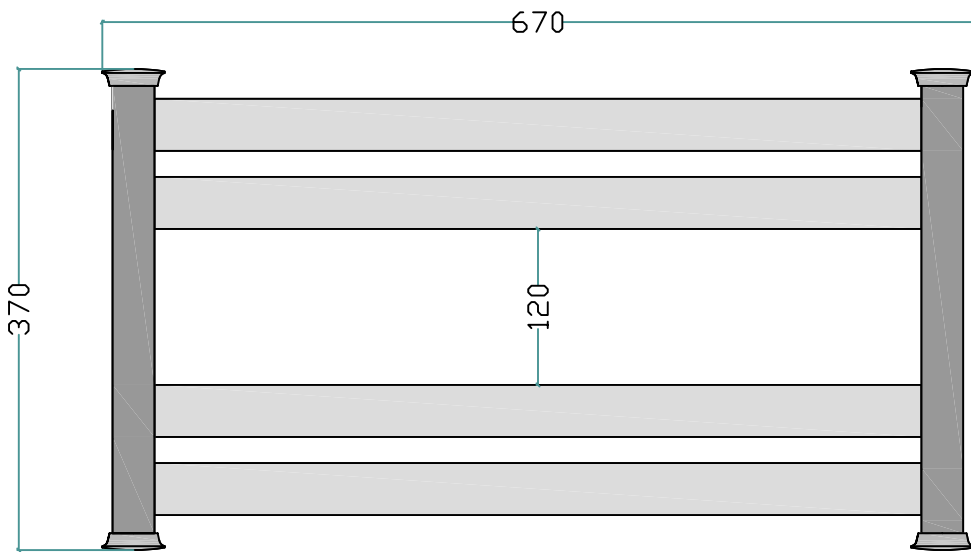
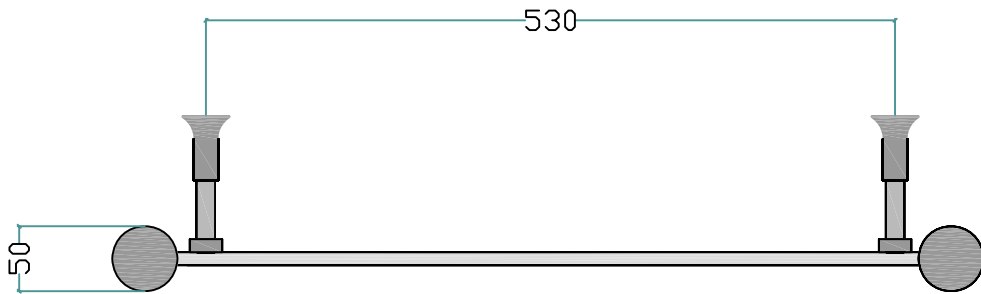

| | |
|----------|-----|
| Watt | 173 |
| BTU | 590 |
| kcal / h | 149 |

Polo 03766-4

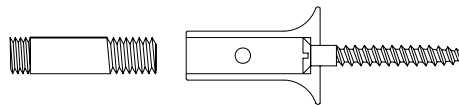
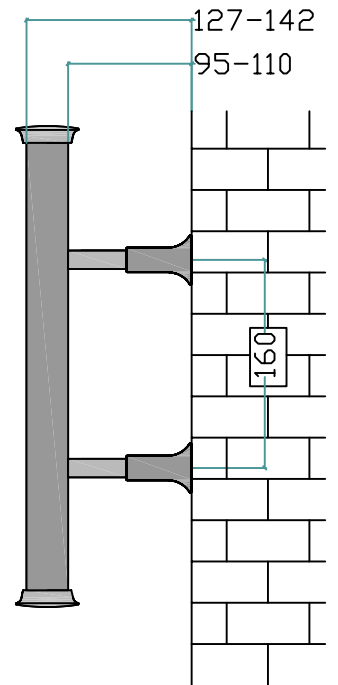
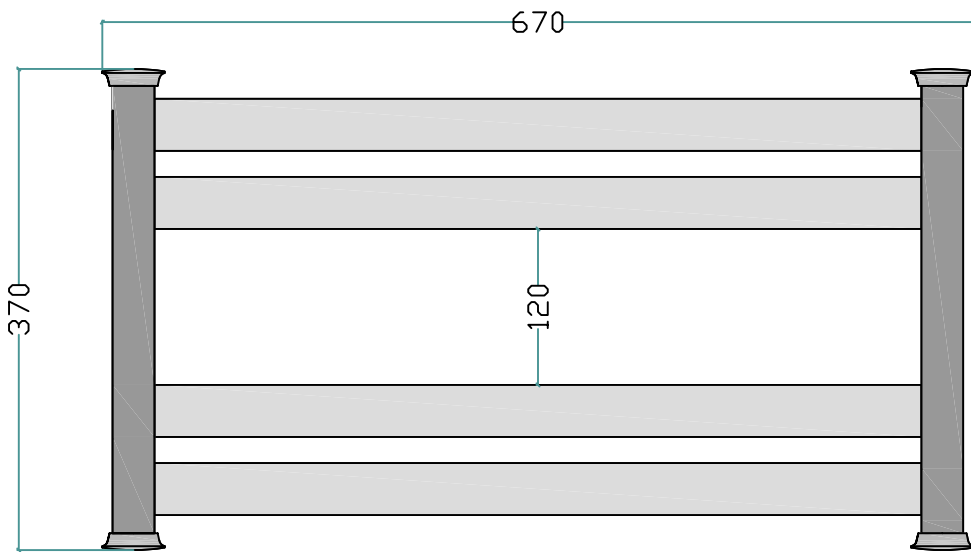
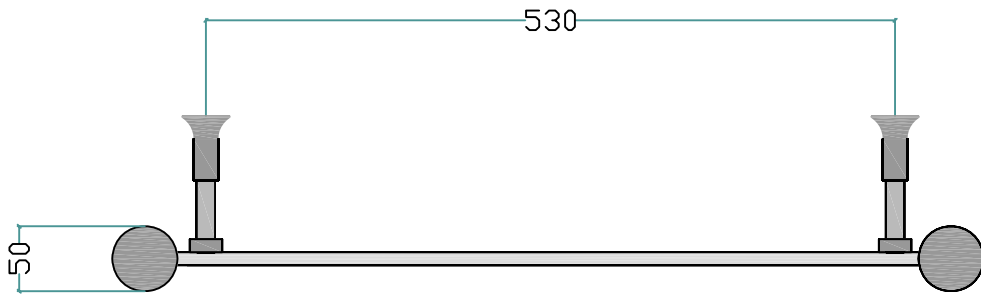

| | |
|----------|-----|
| Watt | 173 |
| BTU | 590 |
| kcal / h | 149 |

Polo 03766-4

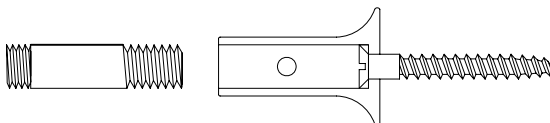
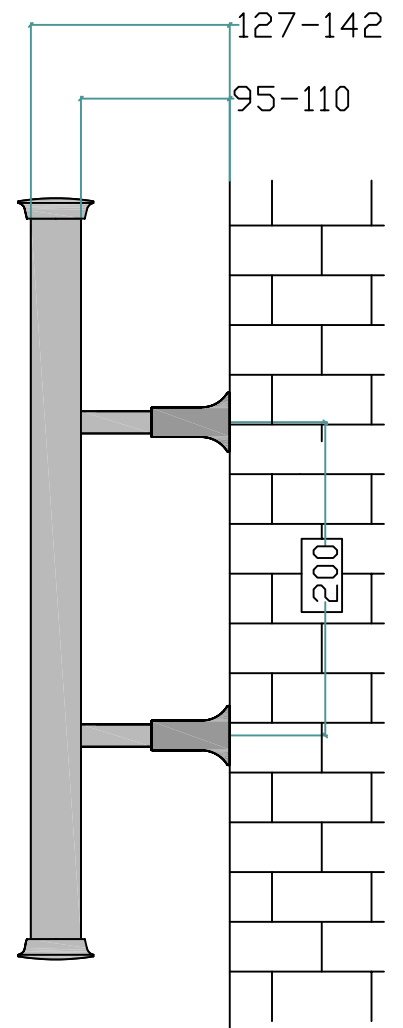
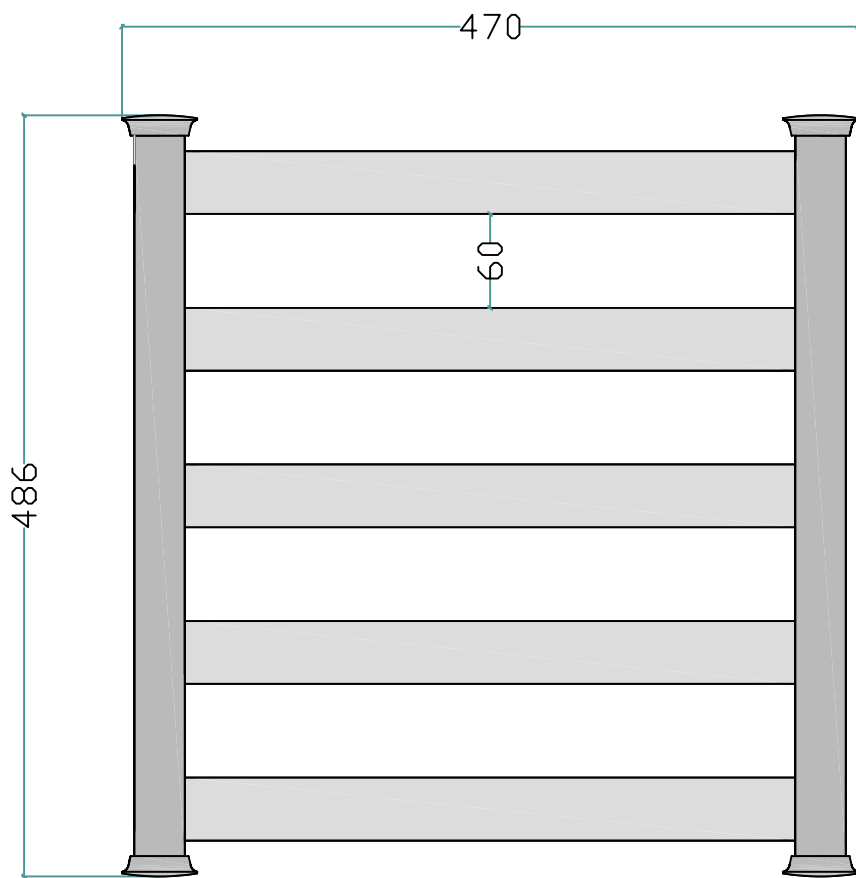
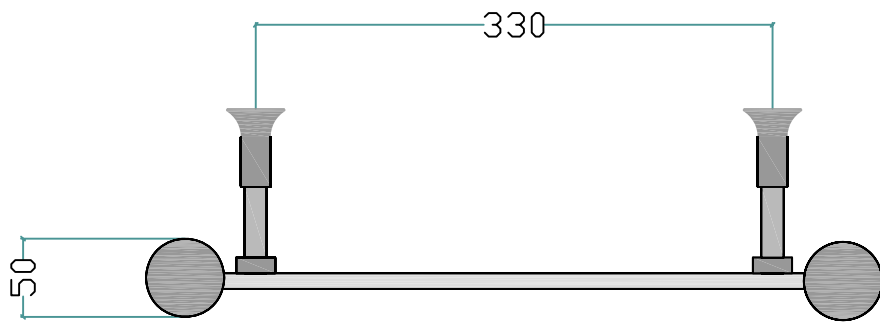

| | |
|----------|-----|
| Watt | 144 |
| BTU | 491 |
| kcal / h | 124 |

Polo 04746-5

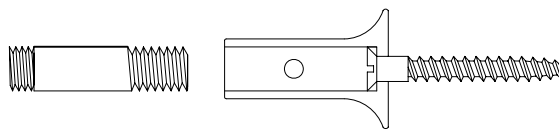
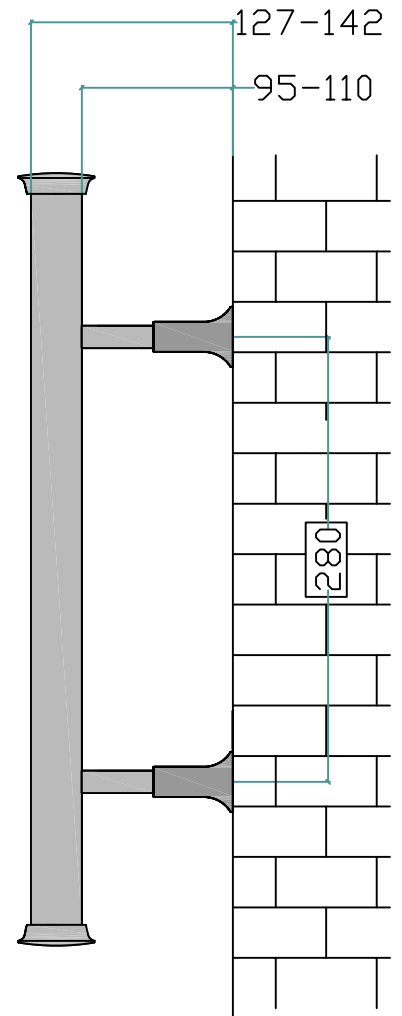
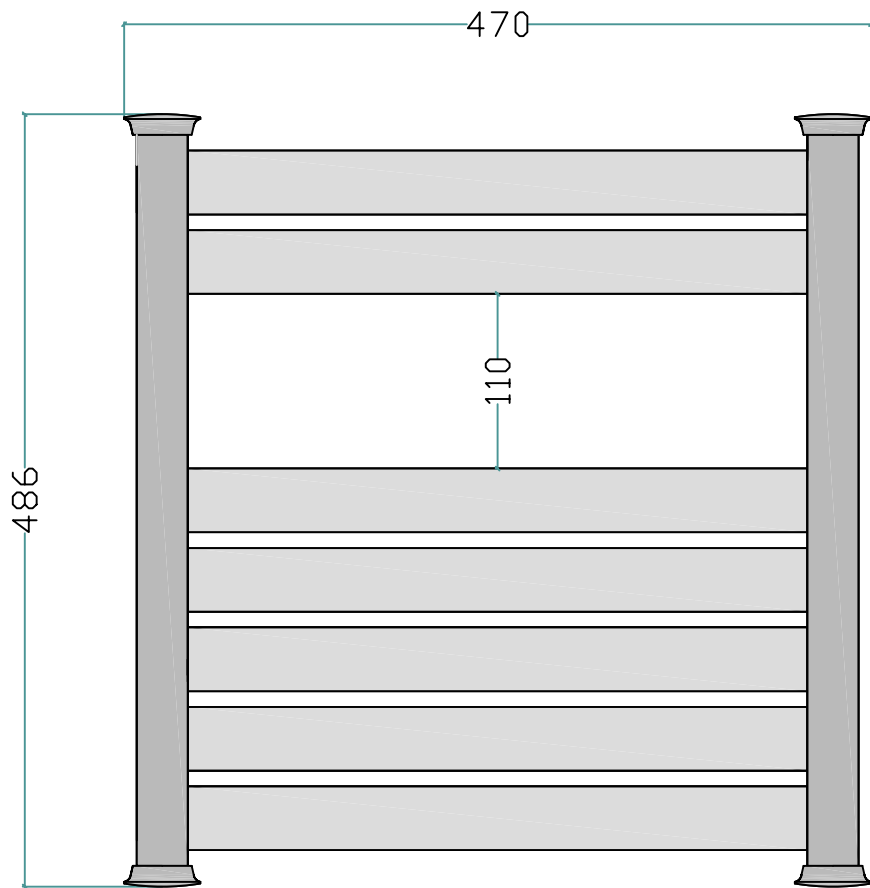
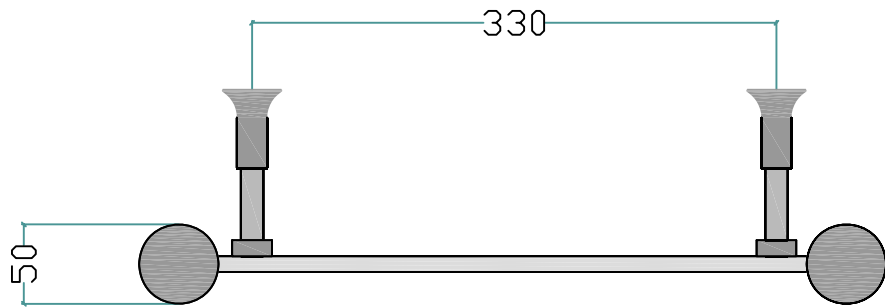

| | |
|----------|-----|
| Watt | 202 |
| BTU | 688 |
| kcal / h | 173 |

Polo 04746-7

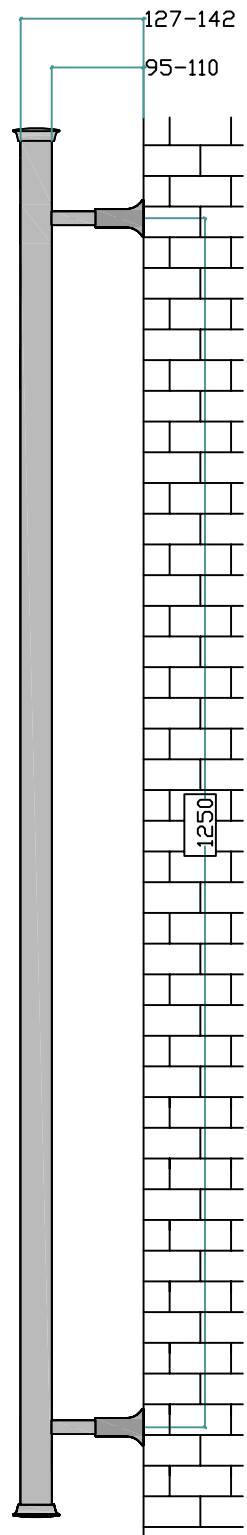
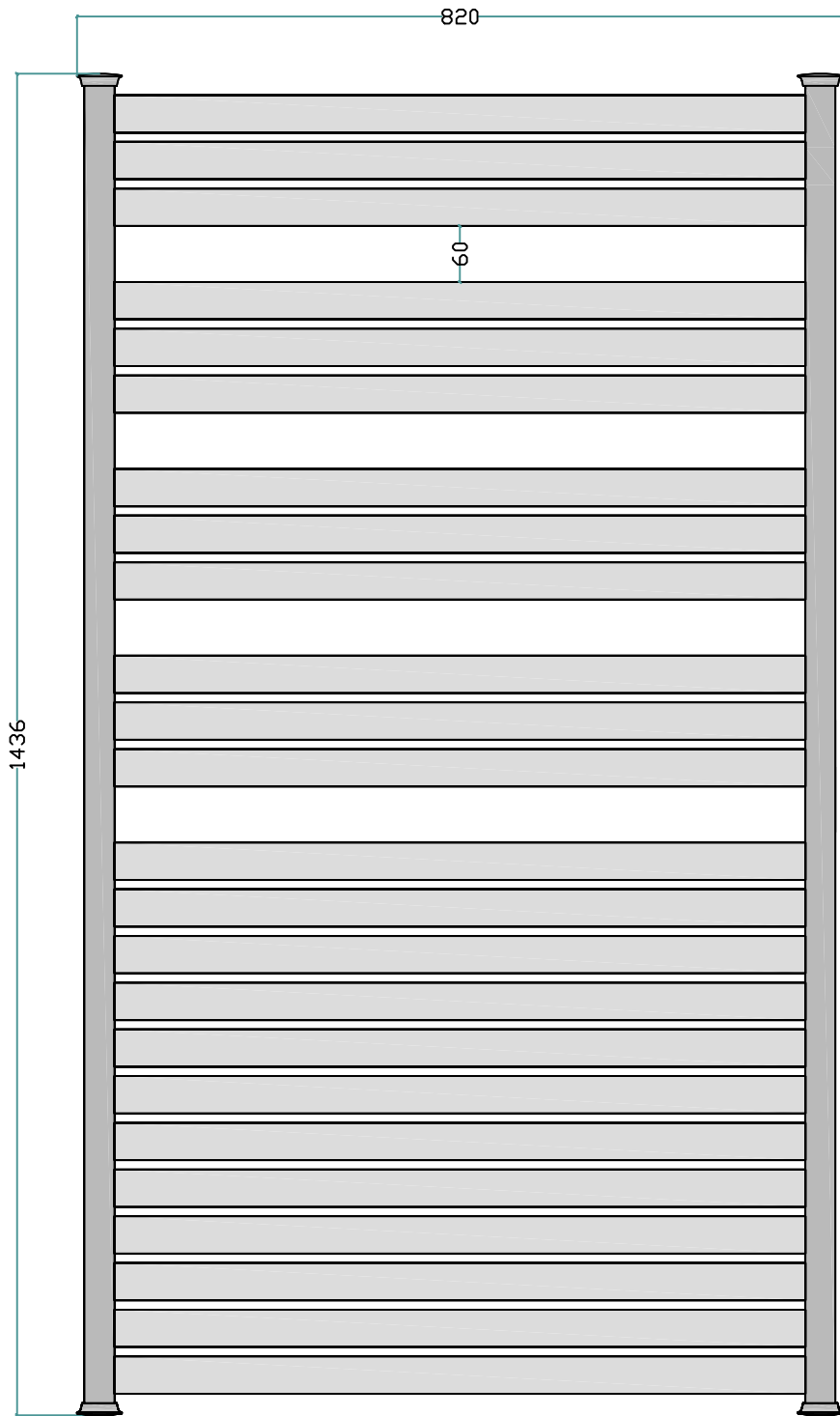
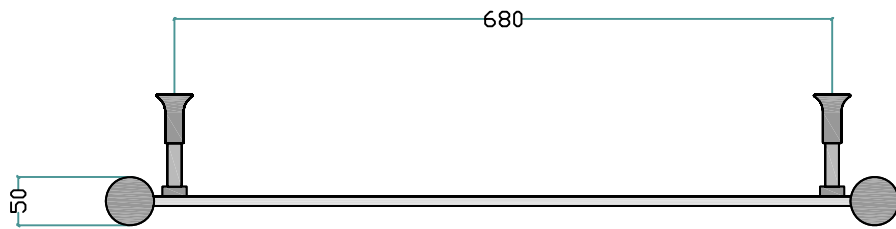

| | |
|----------|-------|
| Watt | 1.296 |
| BTU | 4.422 |
| kcal / h | 1.114 |

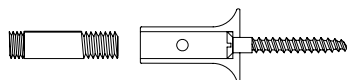

Polo 15082-24