

Watt	823
BTU	2.808
kcal / h	708

Dune 50 / 20

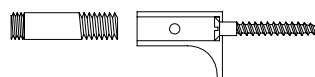
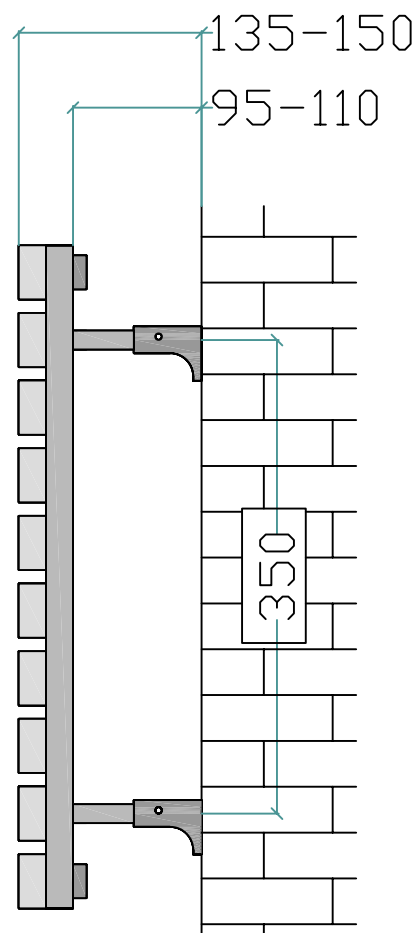
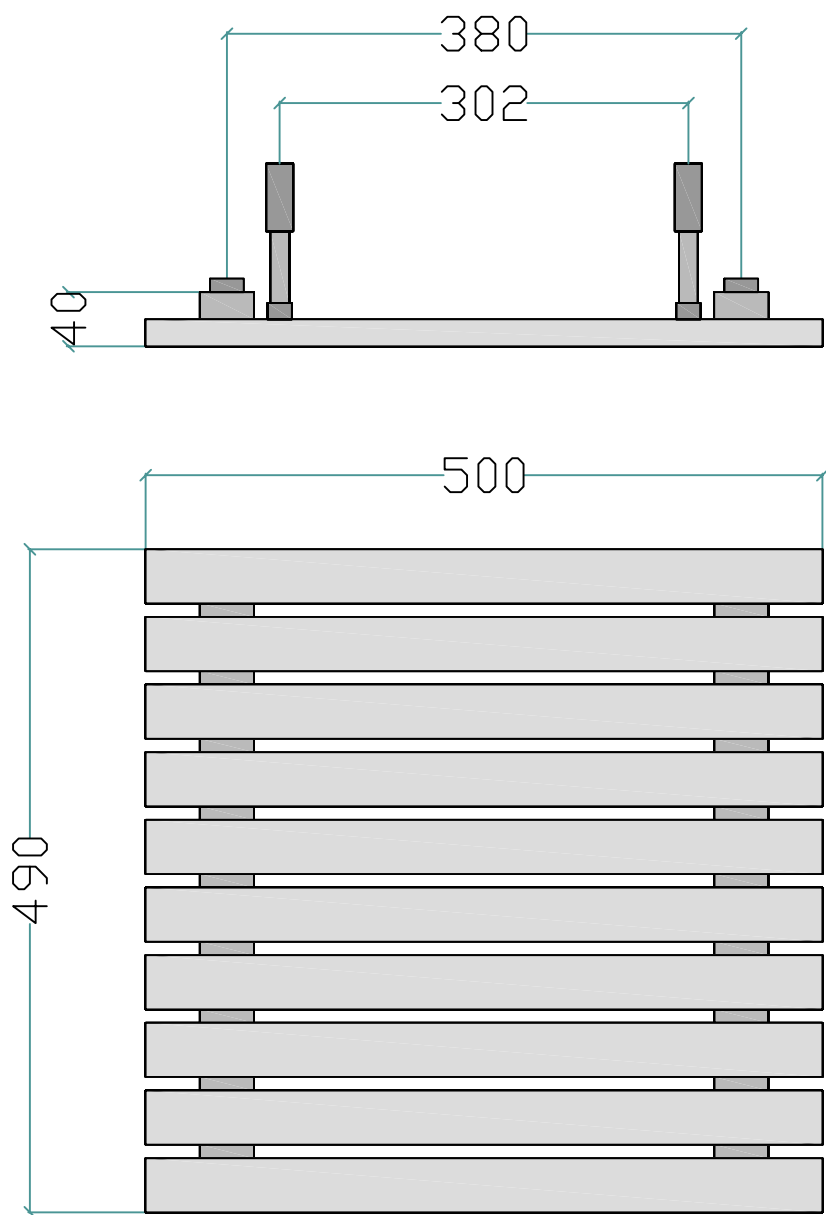

Watt	412
BTU	1.404
kcal / h	354

Dune 50 / 10

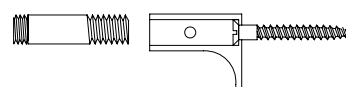
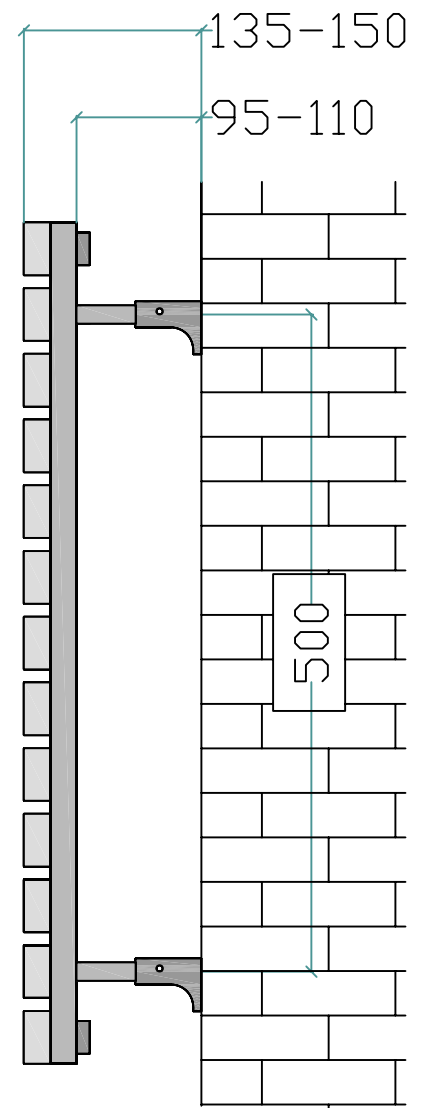
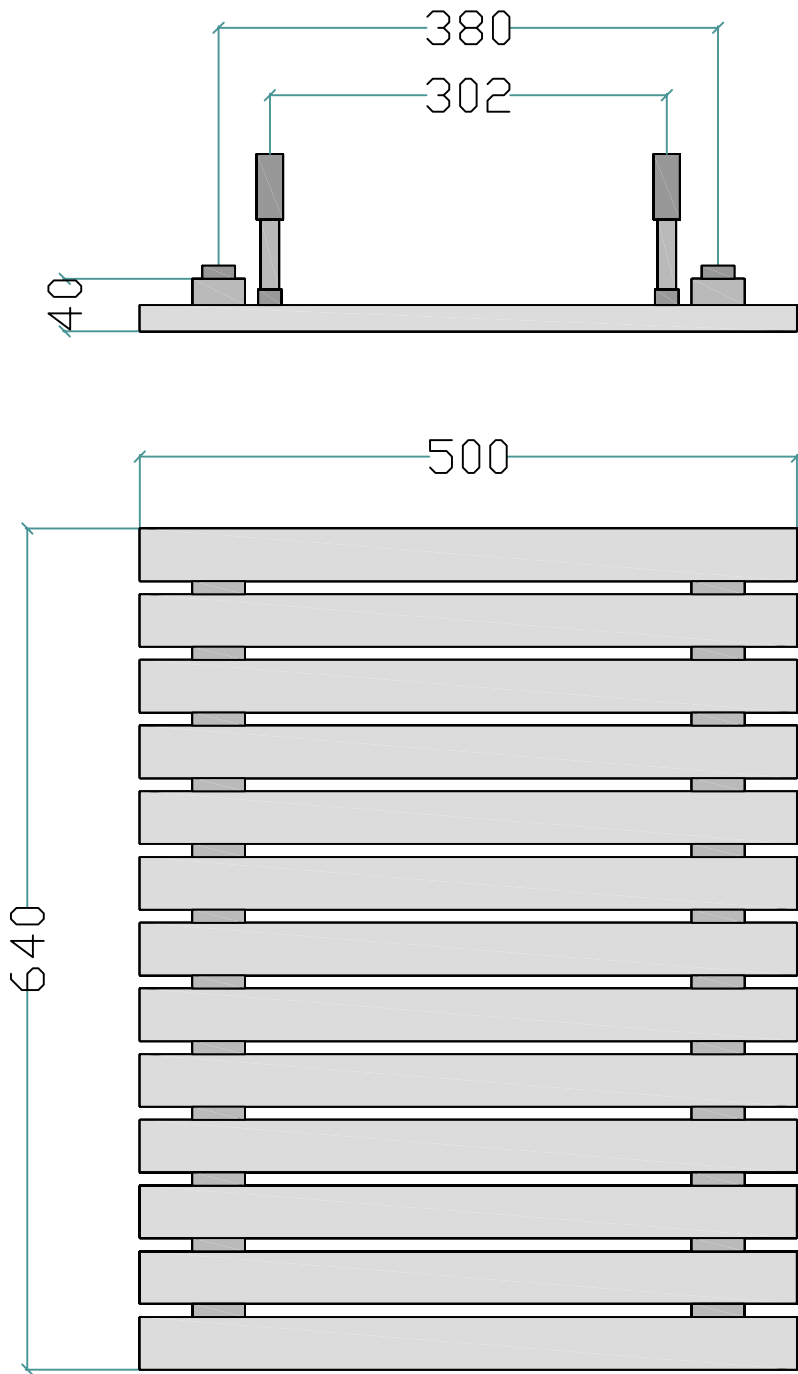

Watt	535
BTU	1.825
kcal / h	460

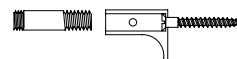
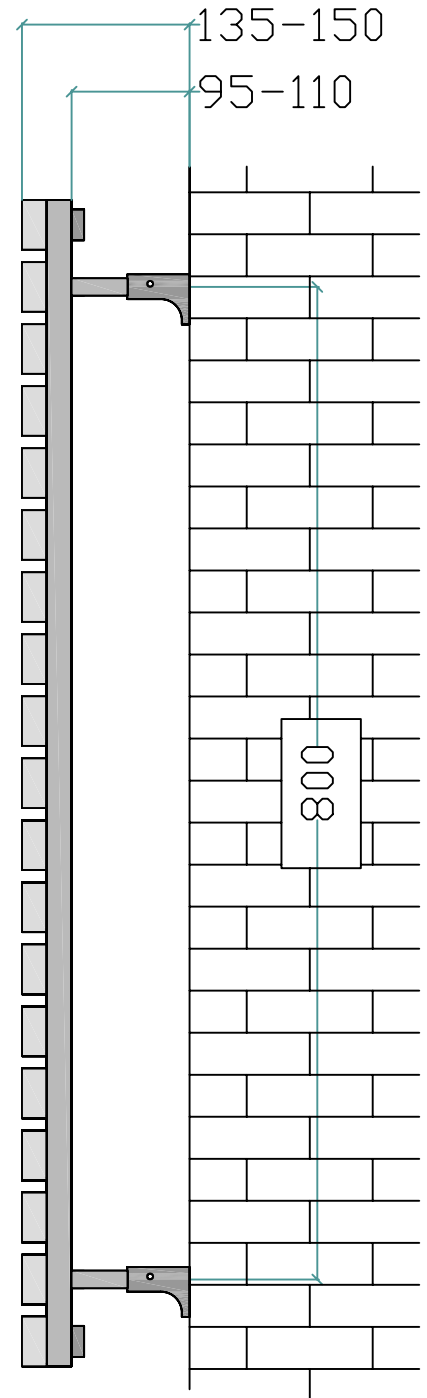
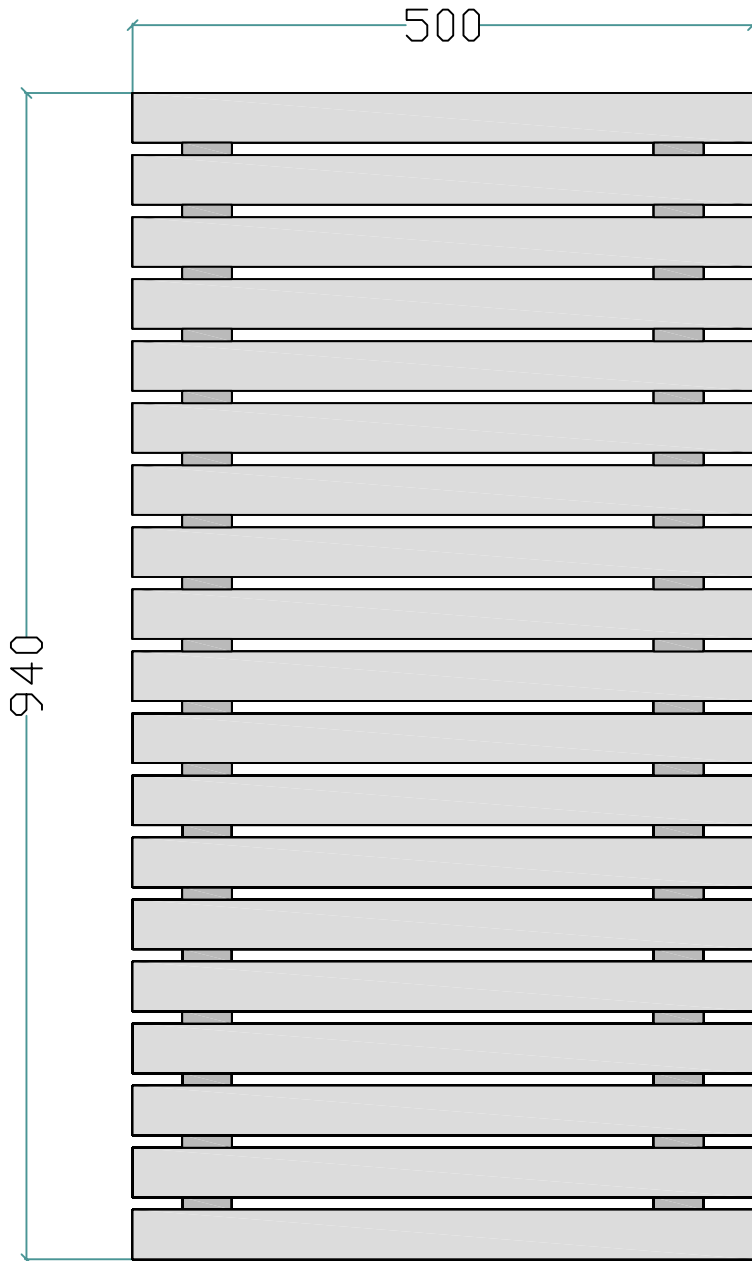
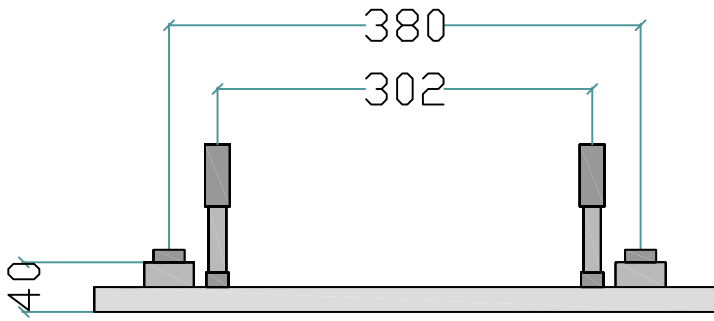

Watt	782
BTU	2.668
kcal / h	672

Dune 50 / 19

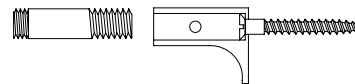
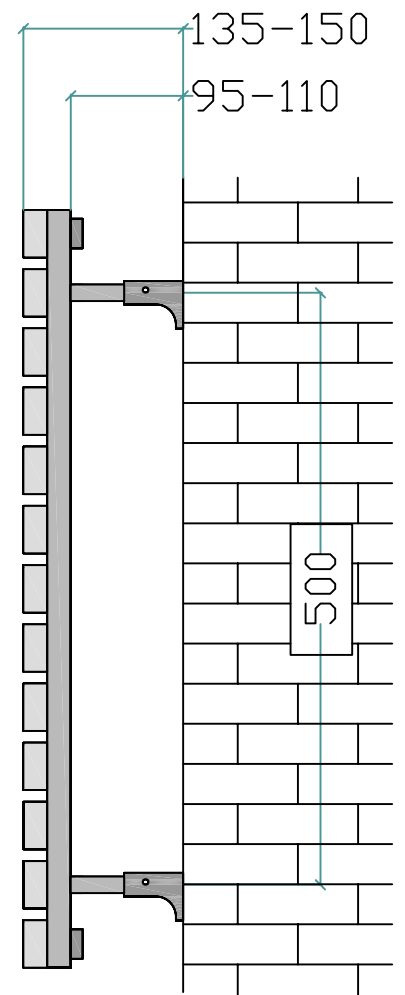
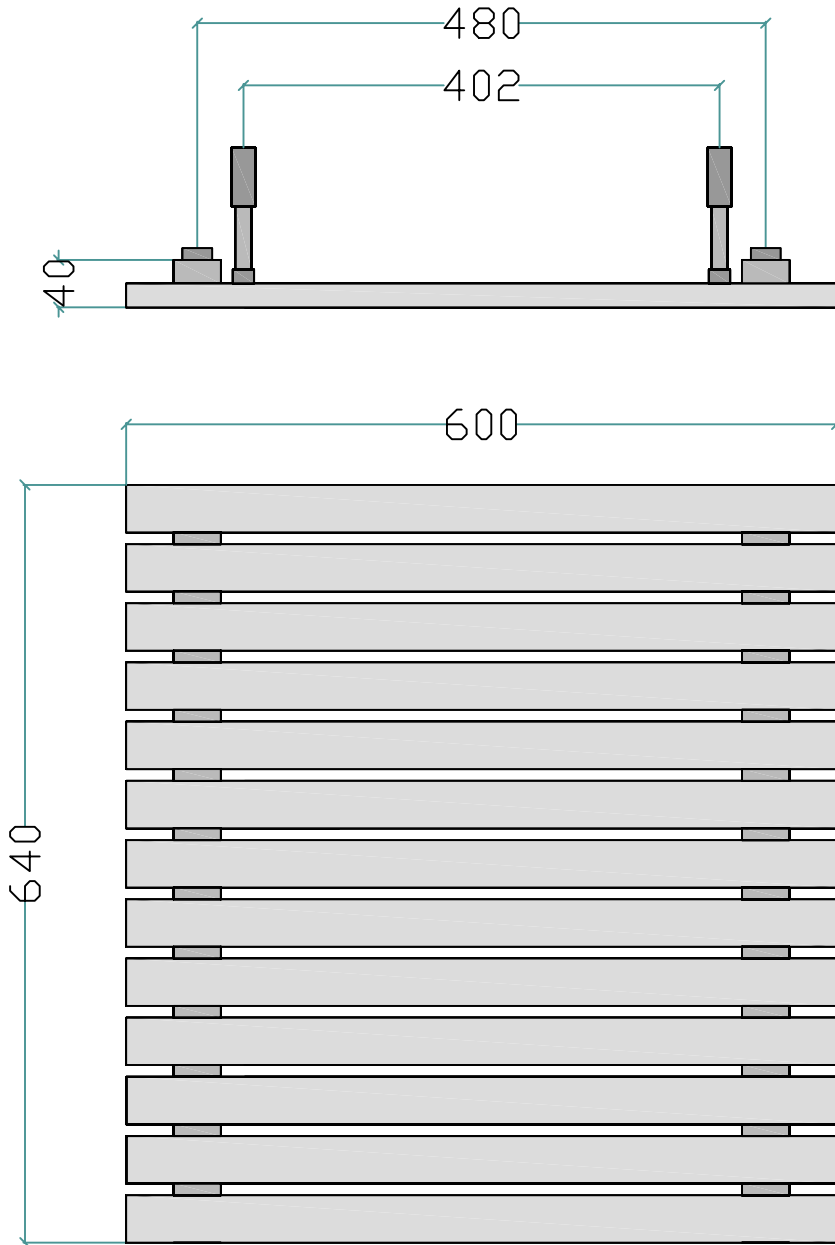

Watt	642
BTU	2.190
kcal / h	552

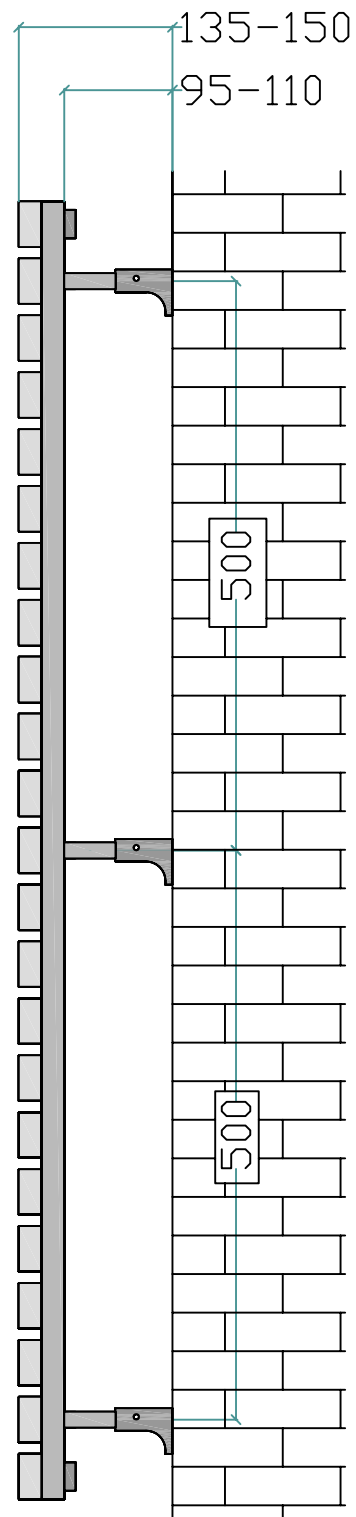
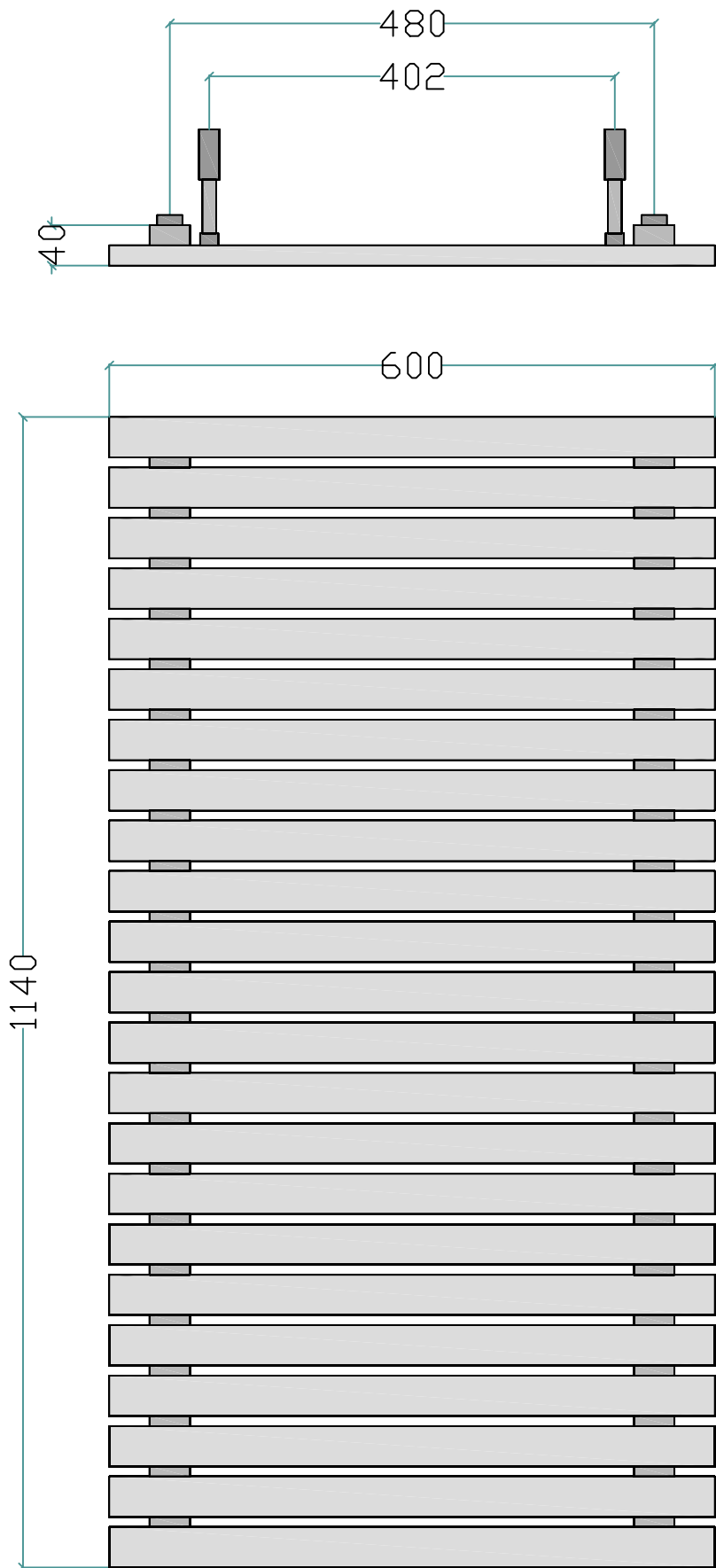

Watt	1.136
BTU	3.875
kcal / h	977

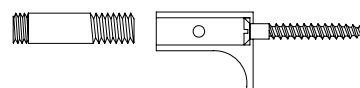

Dune 60 / 23

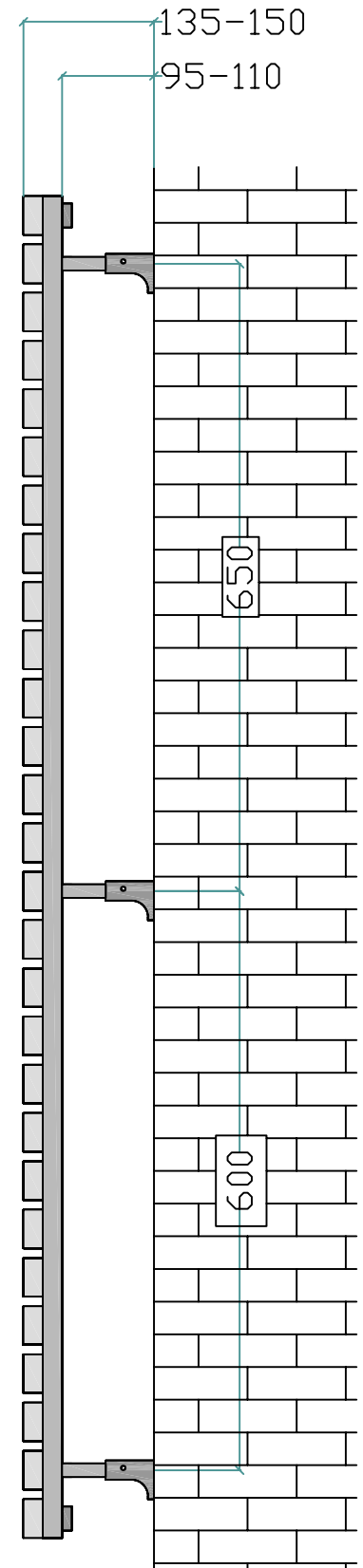
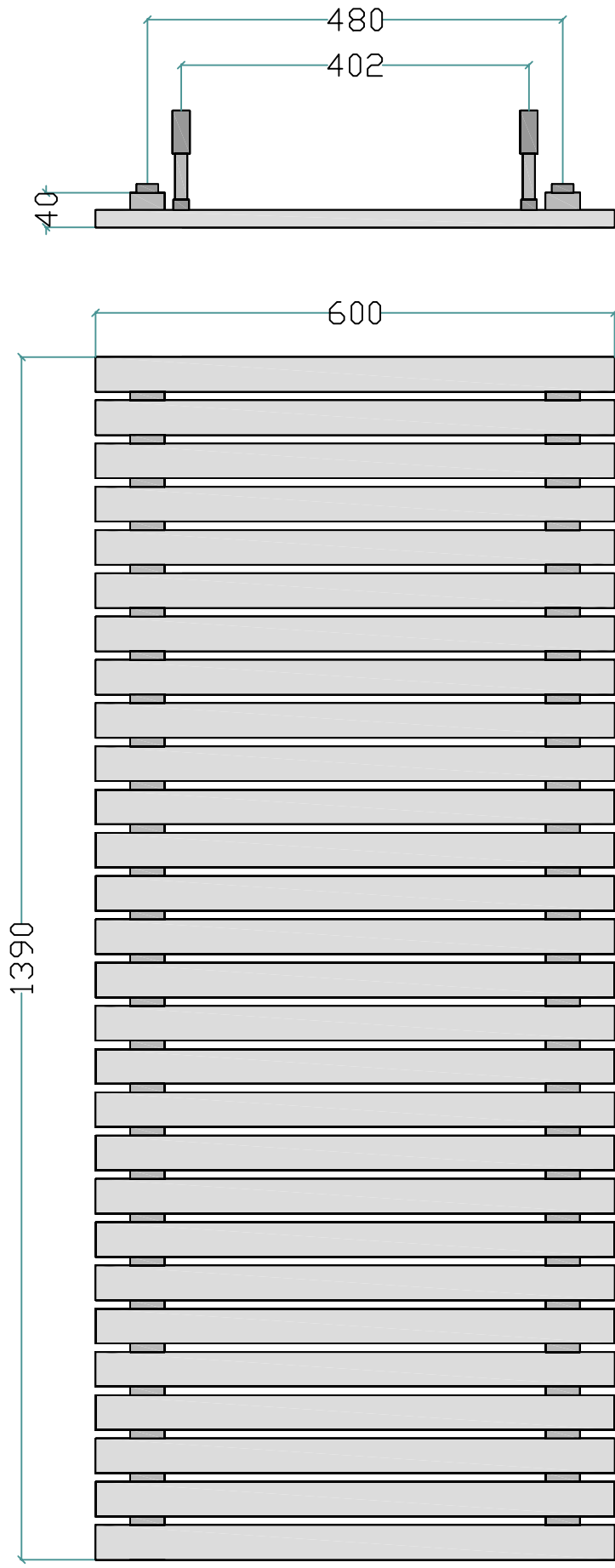

Watt	1.383
BTU	4.718
kcal / h	1.189

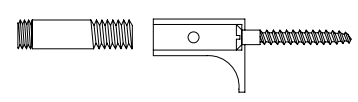

Dune 60 / 28

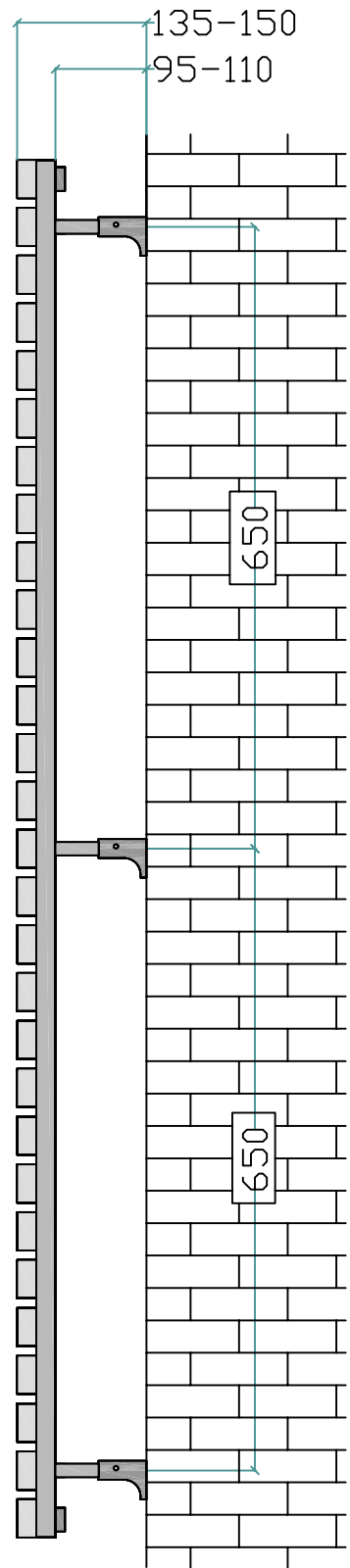
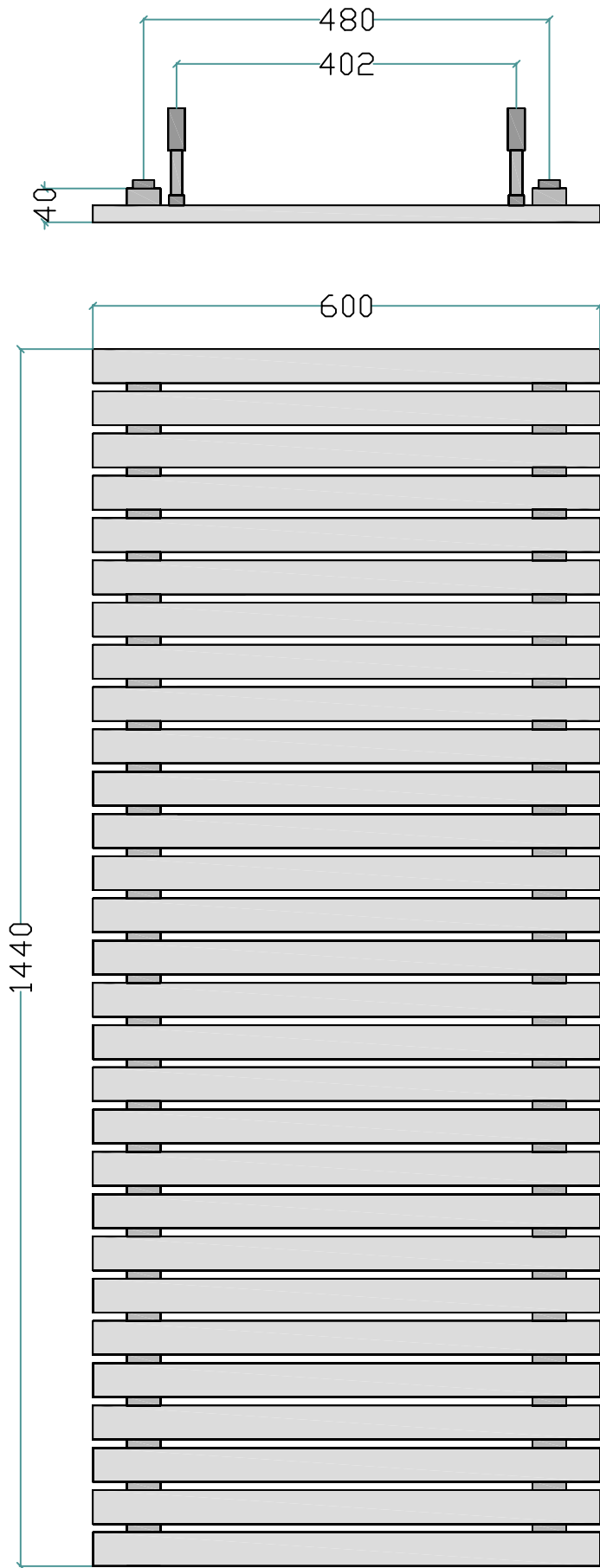

Watt	1.432
BTU	4.886
kcal / h	1.231

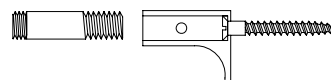

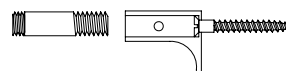
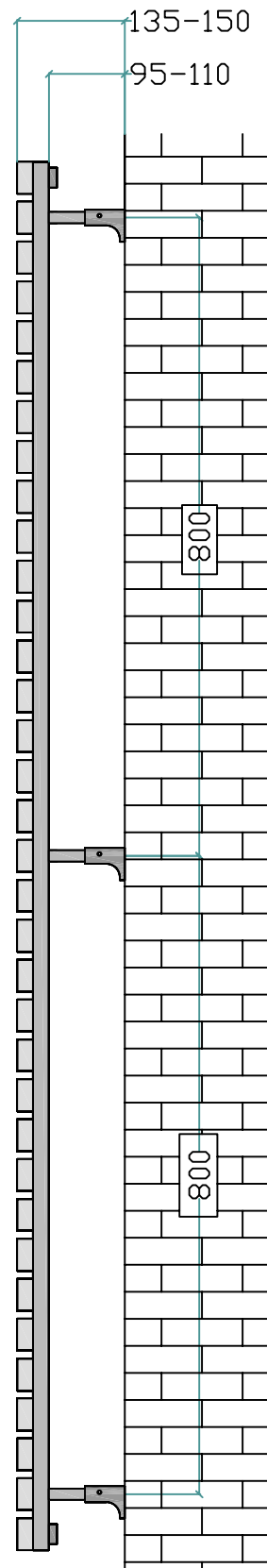
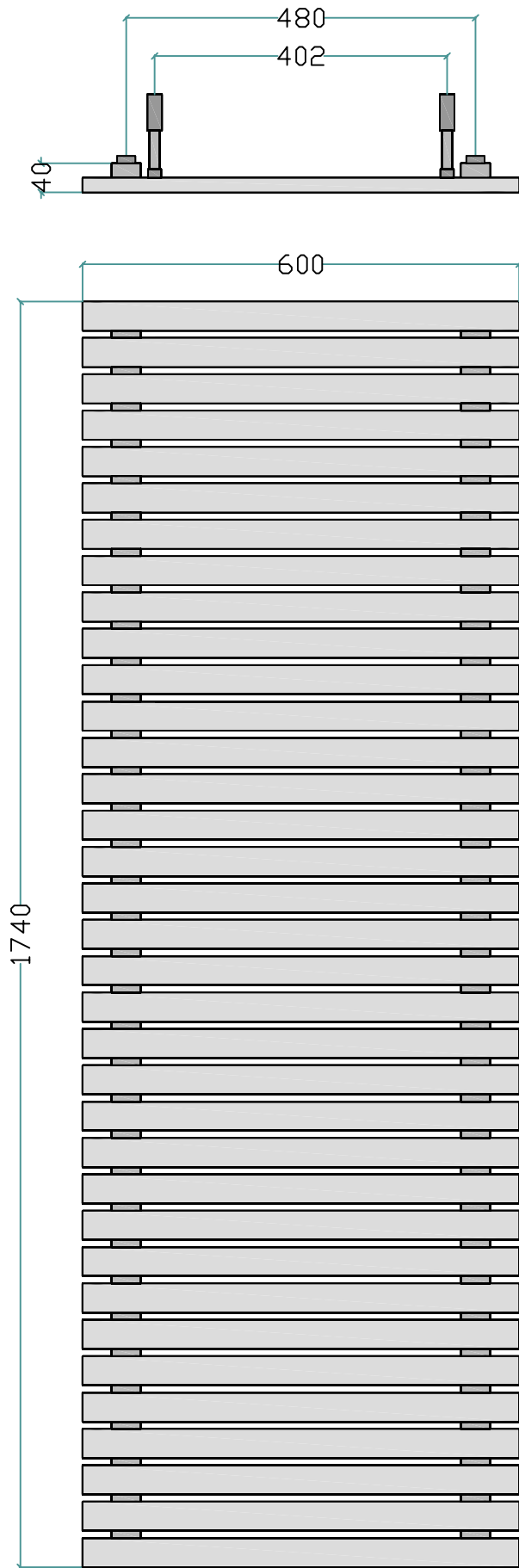

Watt	1.728
BTU	5.897
kcal / h	1.486

Dune 60 / 35

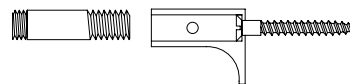
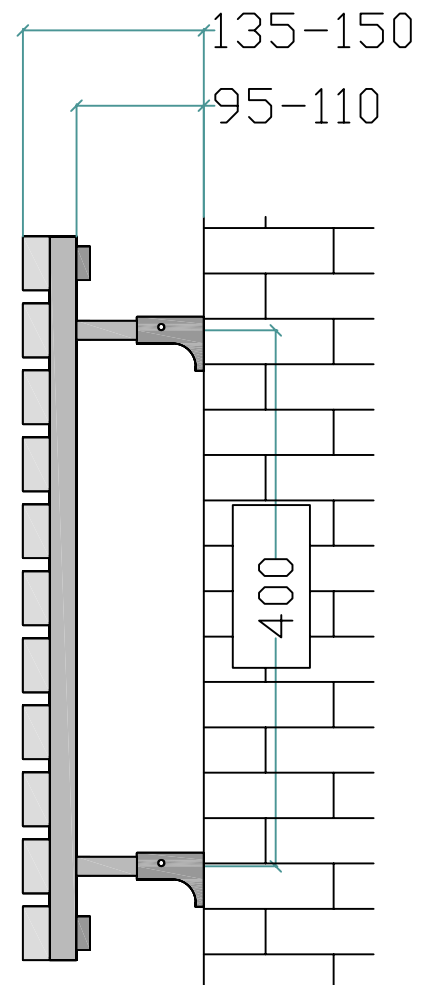
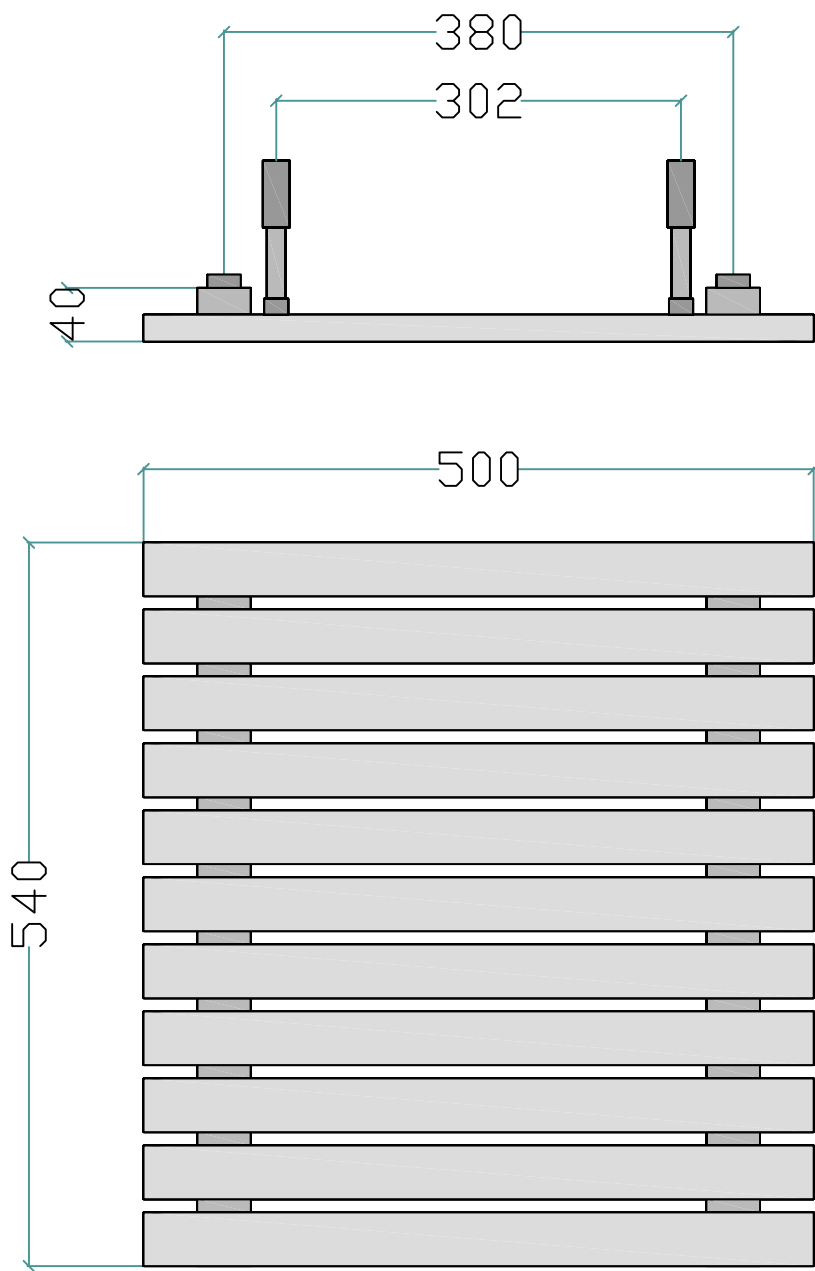

Watt	453
BTU	1.544
kcal / h	389

Dune 50 / 11

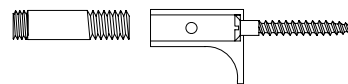
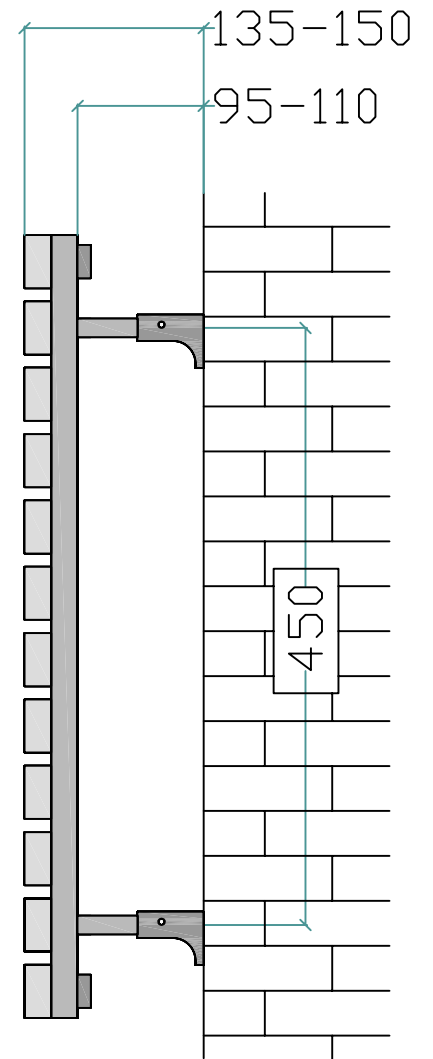
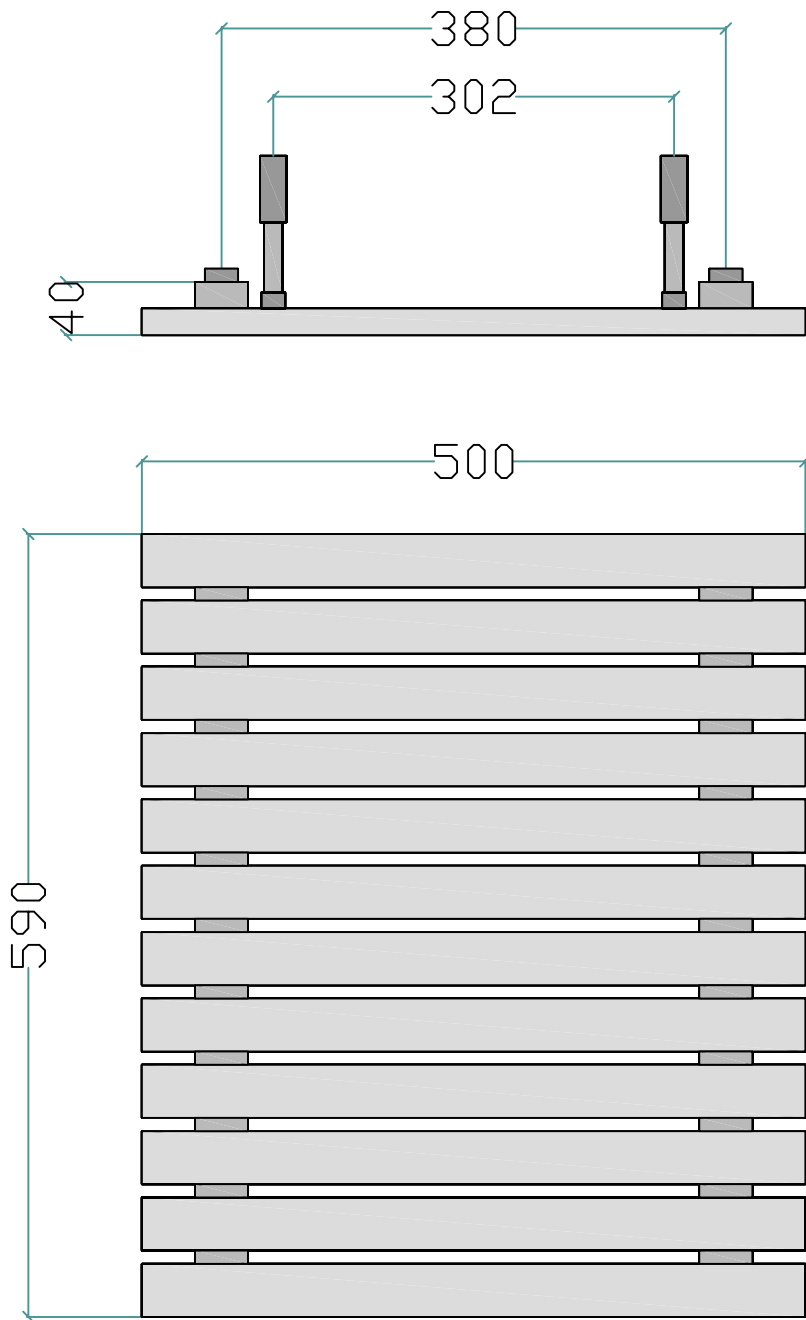

Watt	494
BTU	1.685
kcal / h	425

Dune 50 / 12

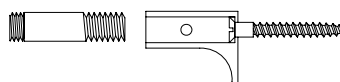
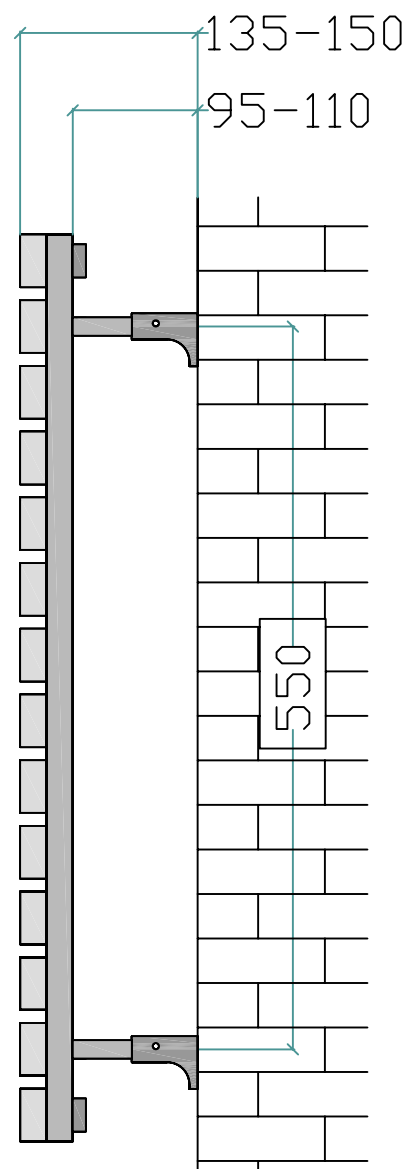
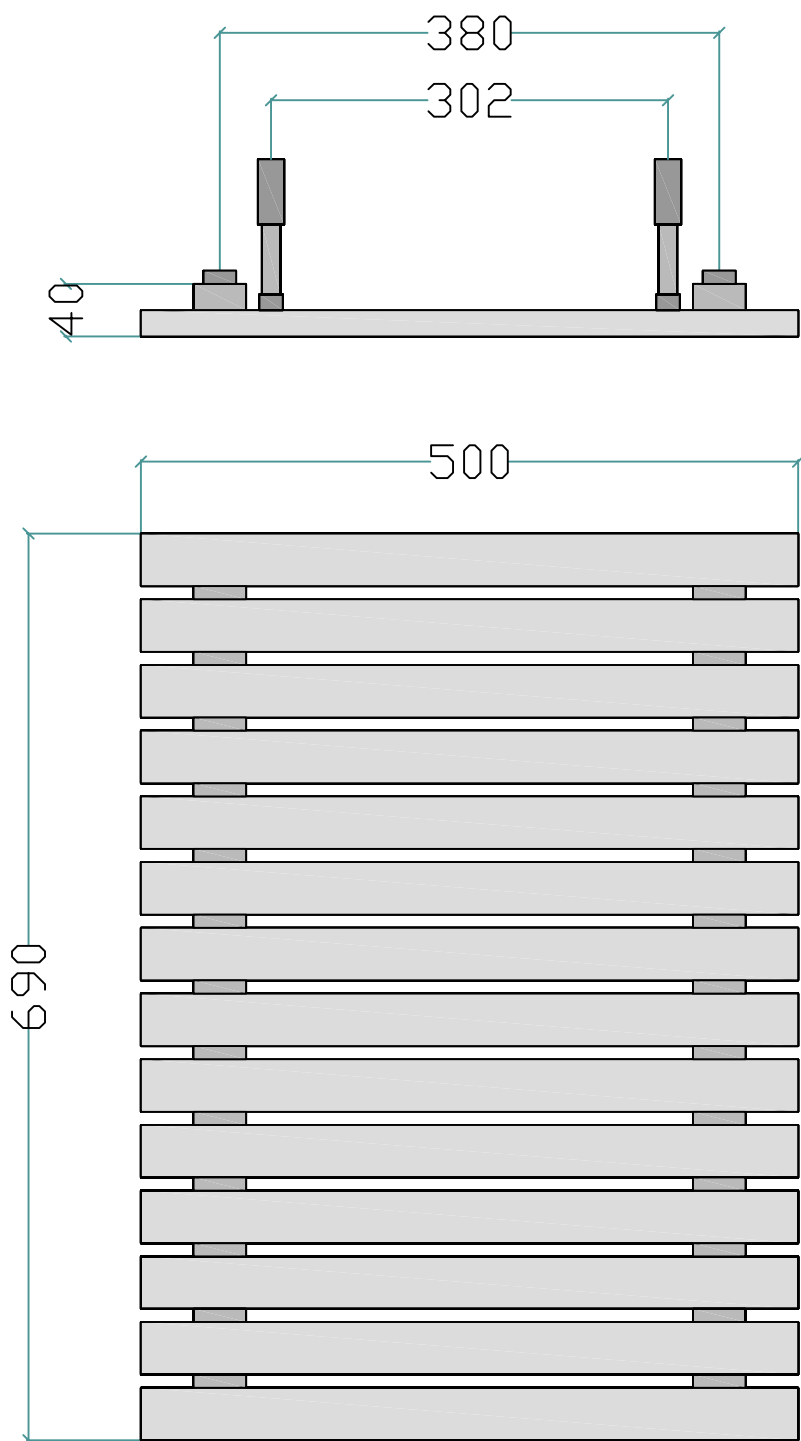

Watt	576
BTU	1.966
kcal / h	495

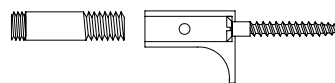
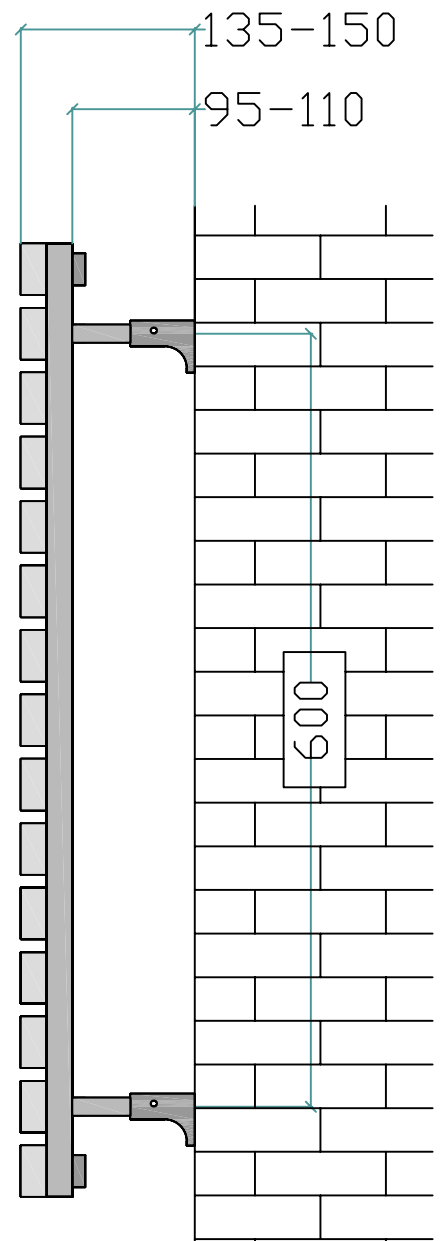
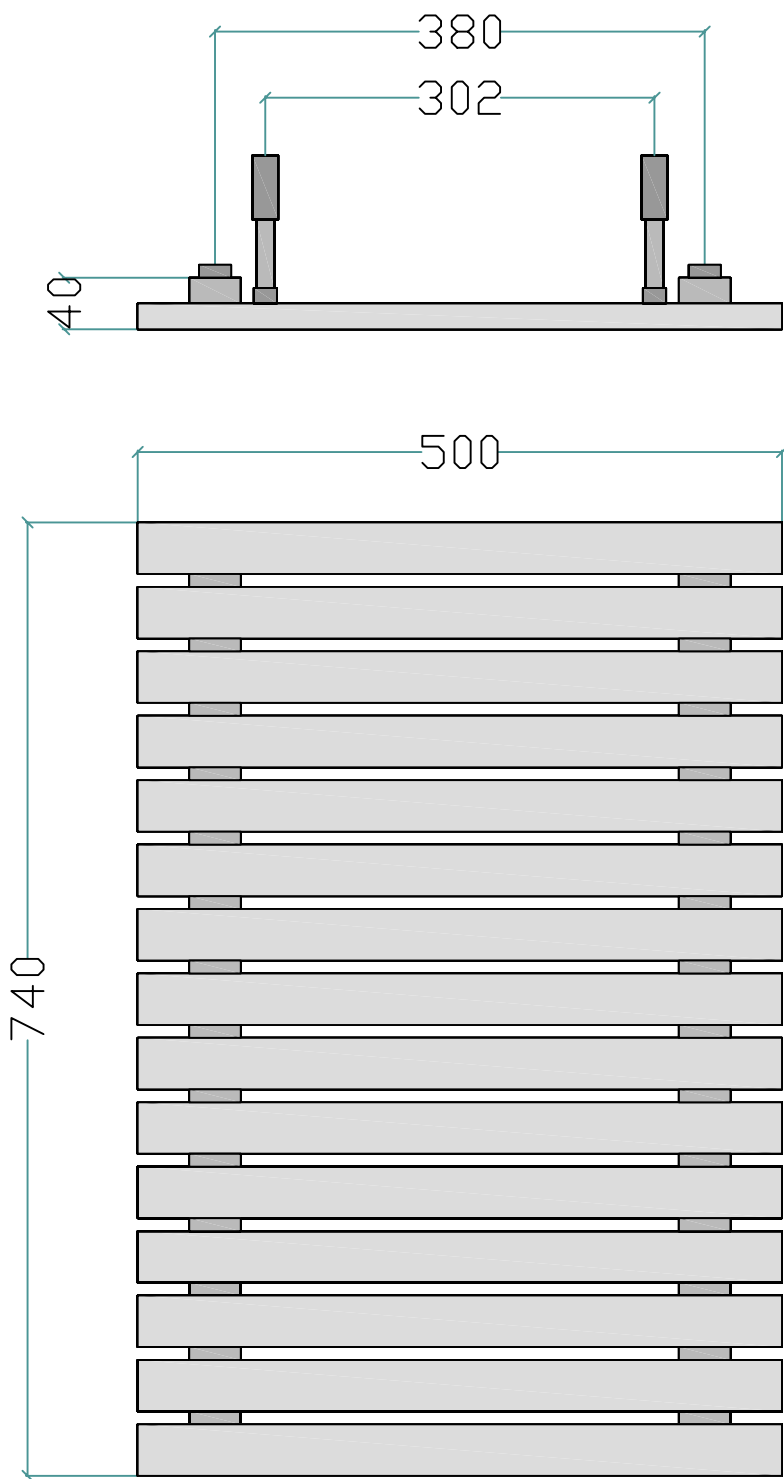

Watt	617
BTU	2.106
kcal / h	531

Dune 50 / 15

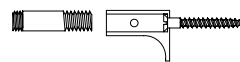
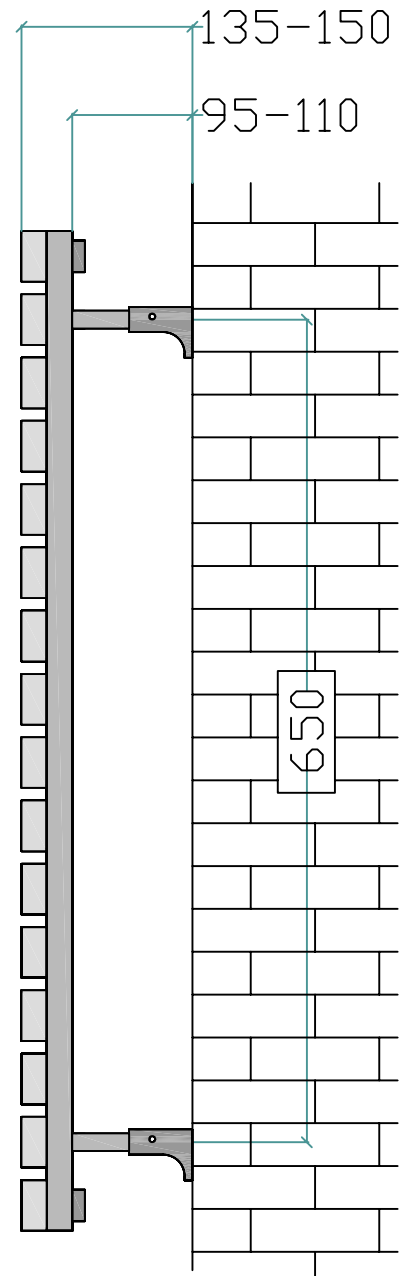
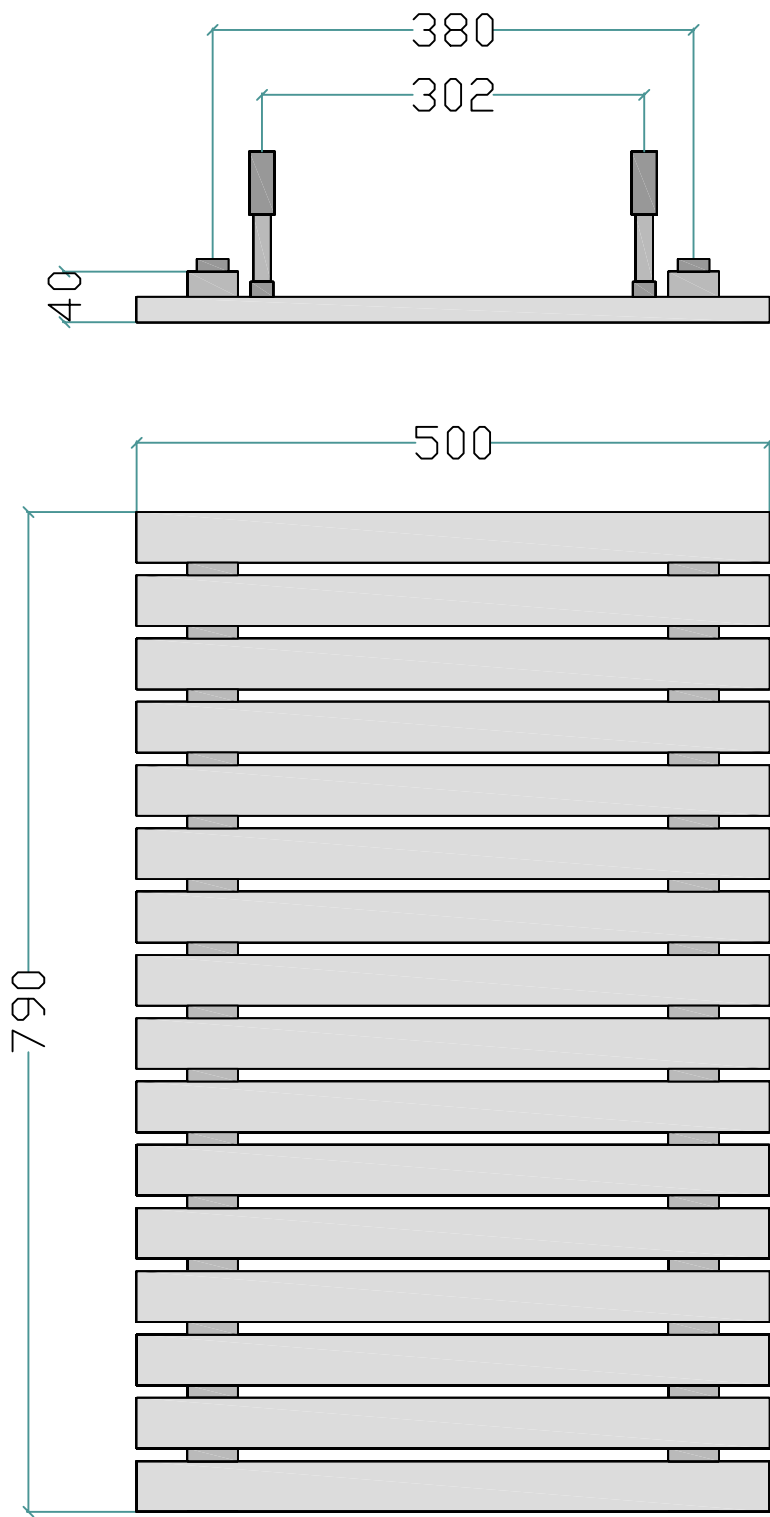

Watt	658
BTU	2.247
kcal / h	566

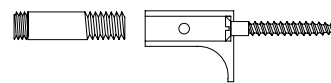
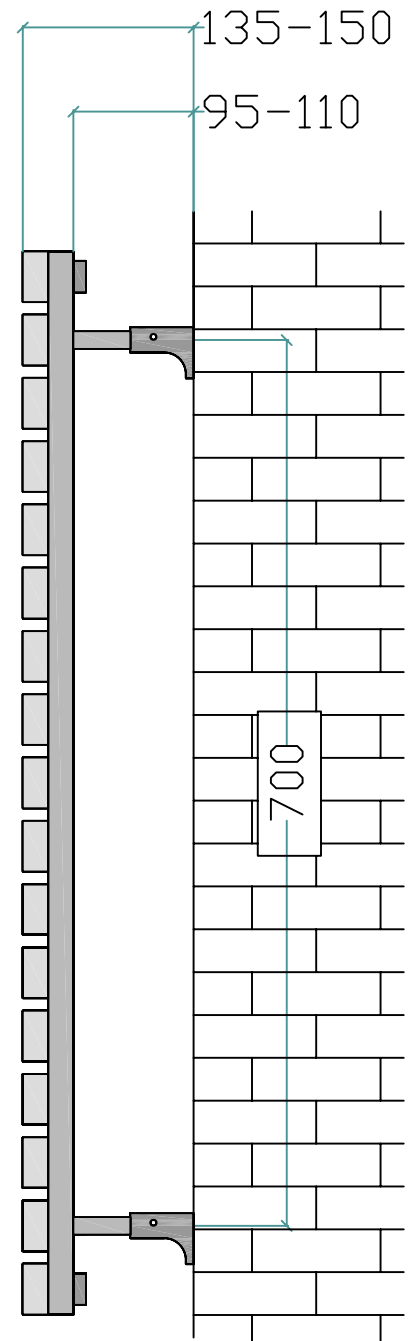
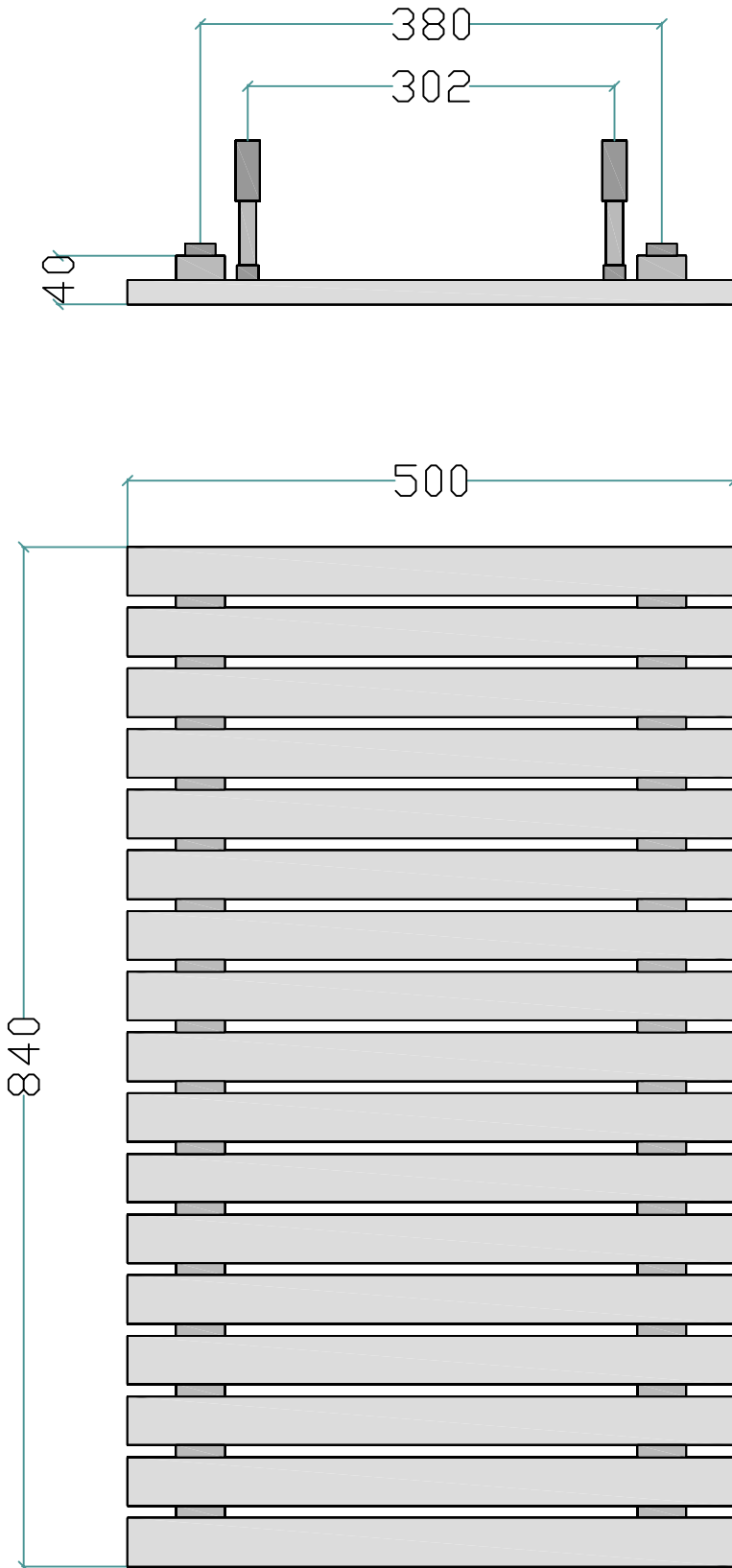

Watt	700
BTU	2.387
kcal / h	601

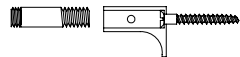
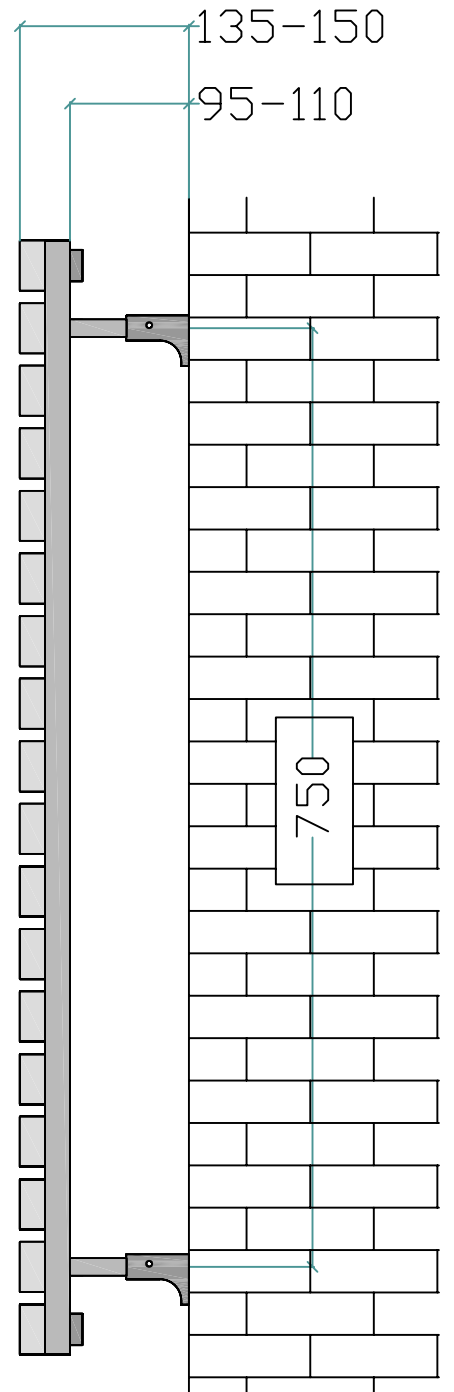
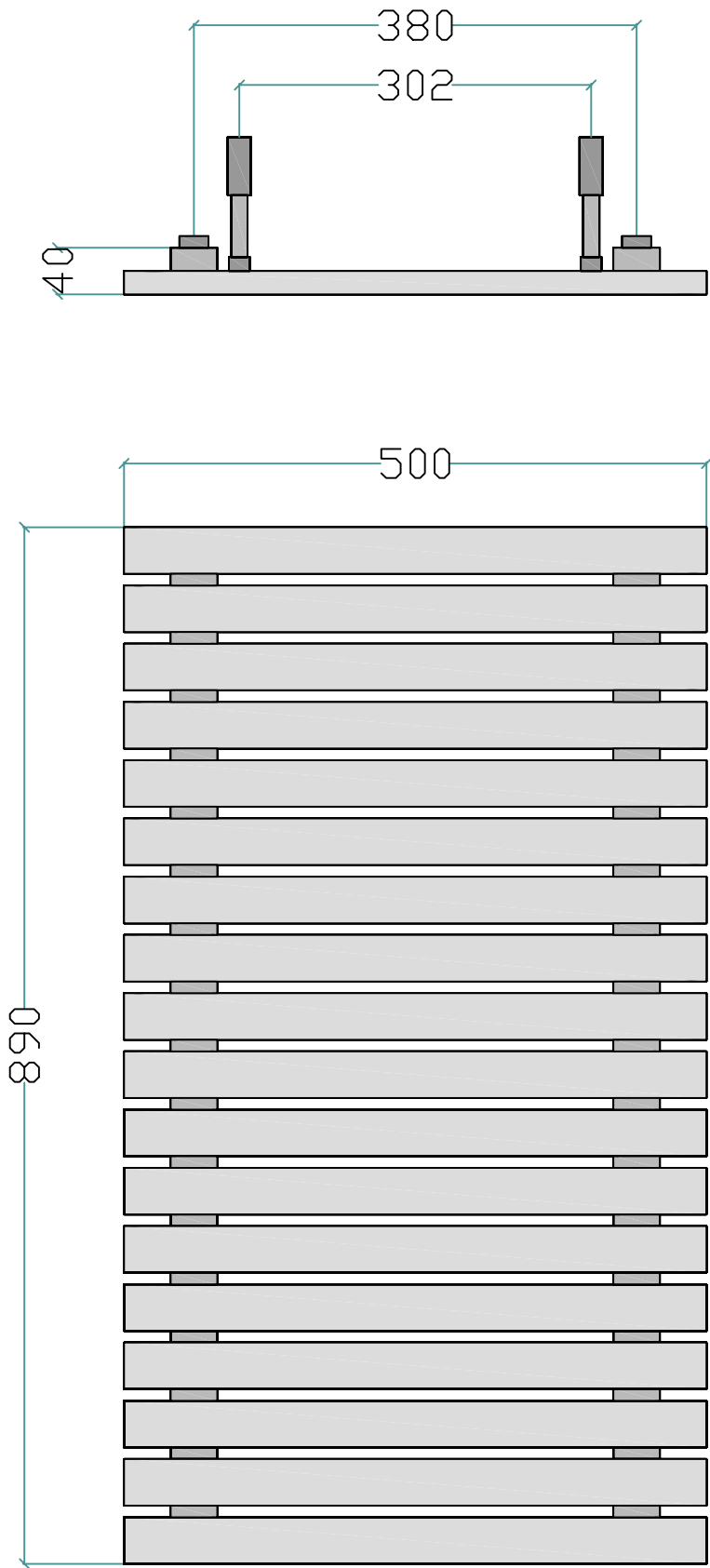

Watt	741
BTU	2.527
kcal / h	637

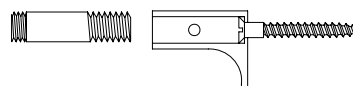
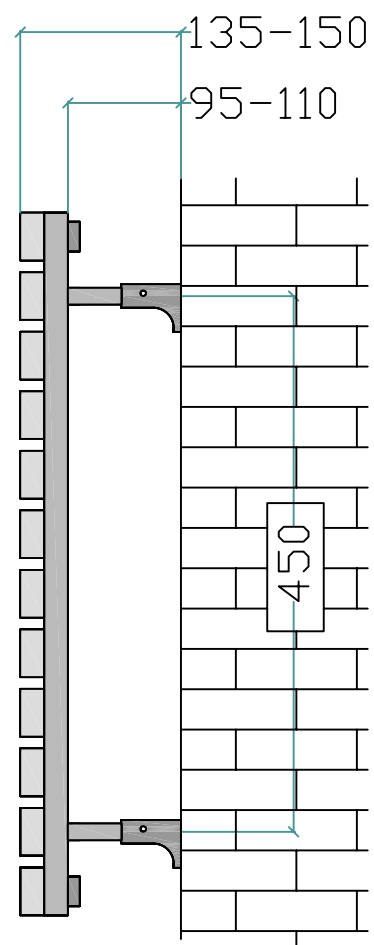
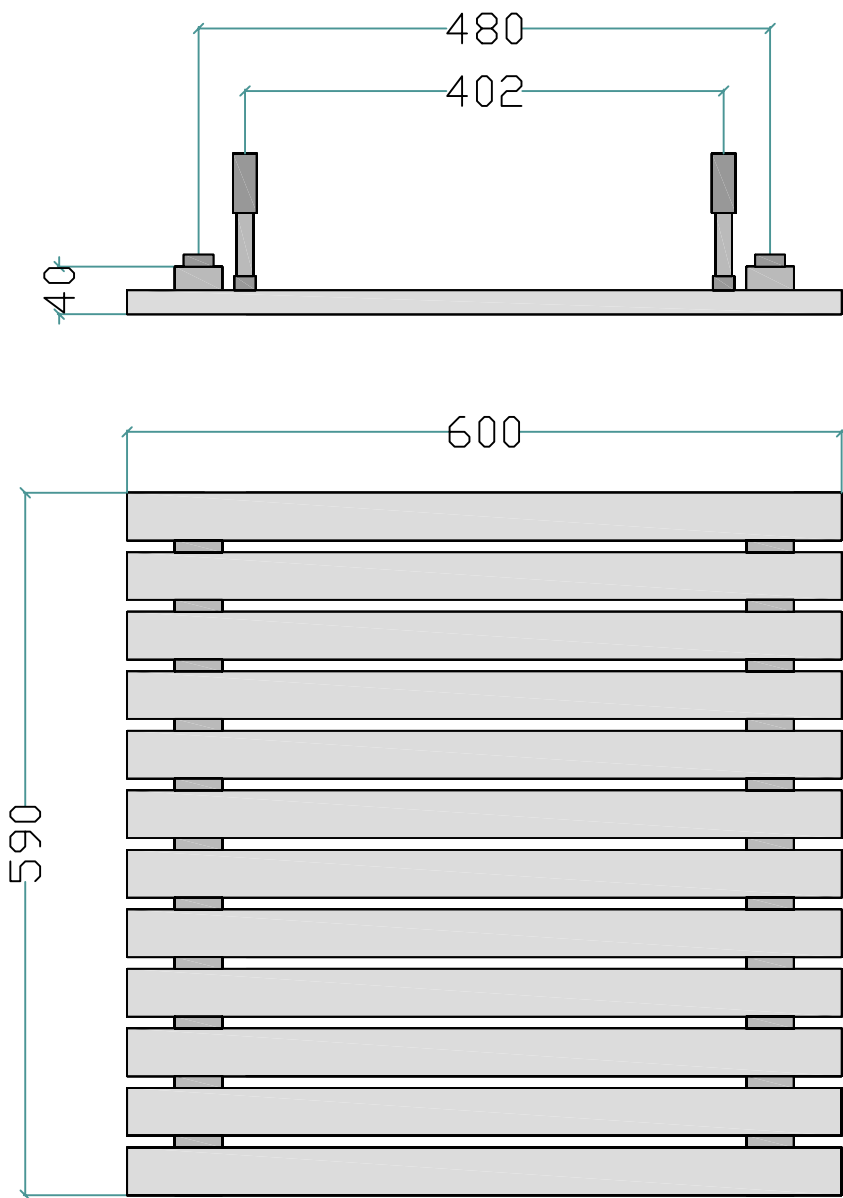

Watt	593
BTU	2.022
kcal / h	509

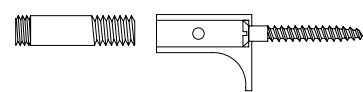
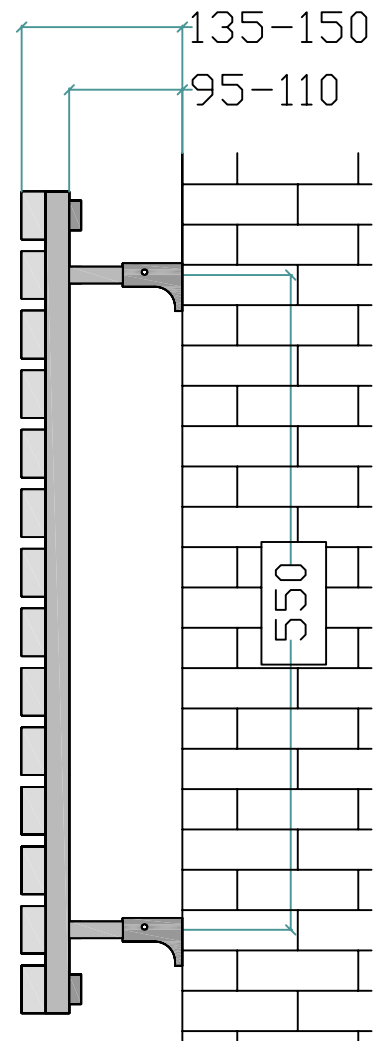
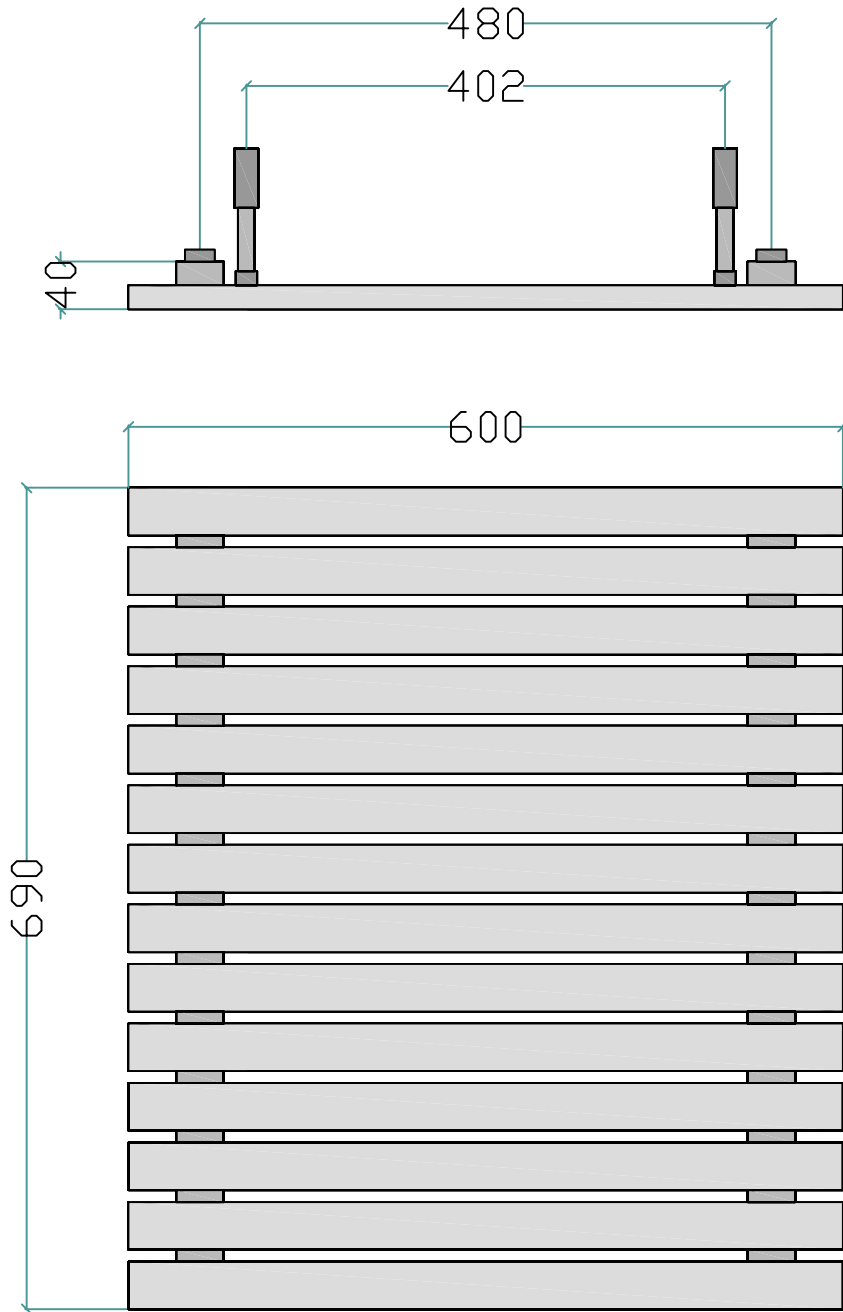

Watt	691
BTU	2.359
kcal / h	594

Dune 60 / 14

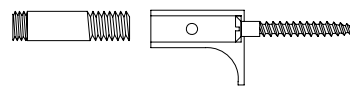
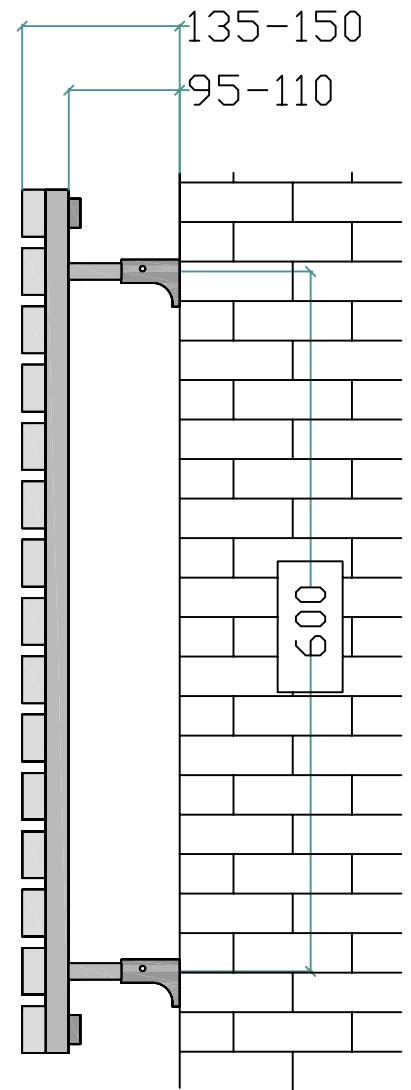
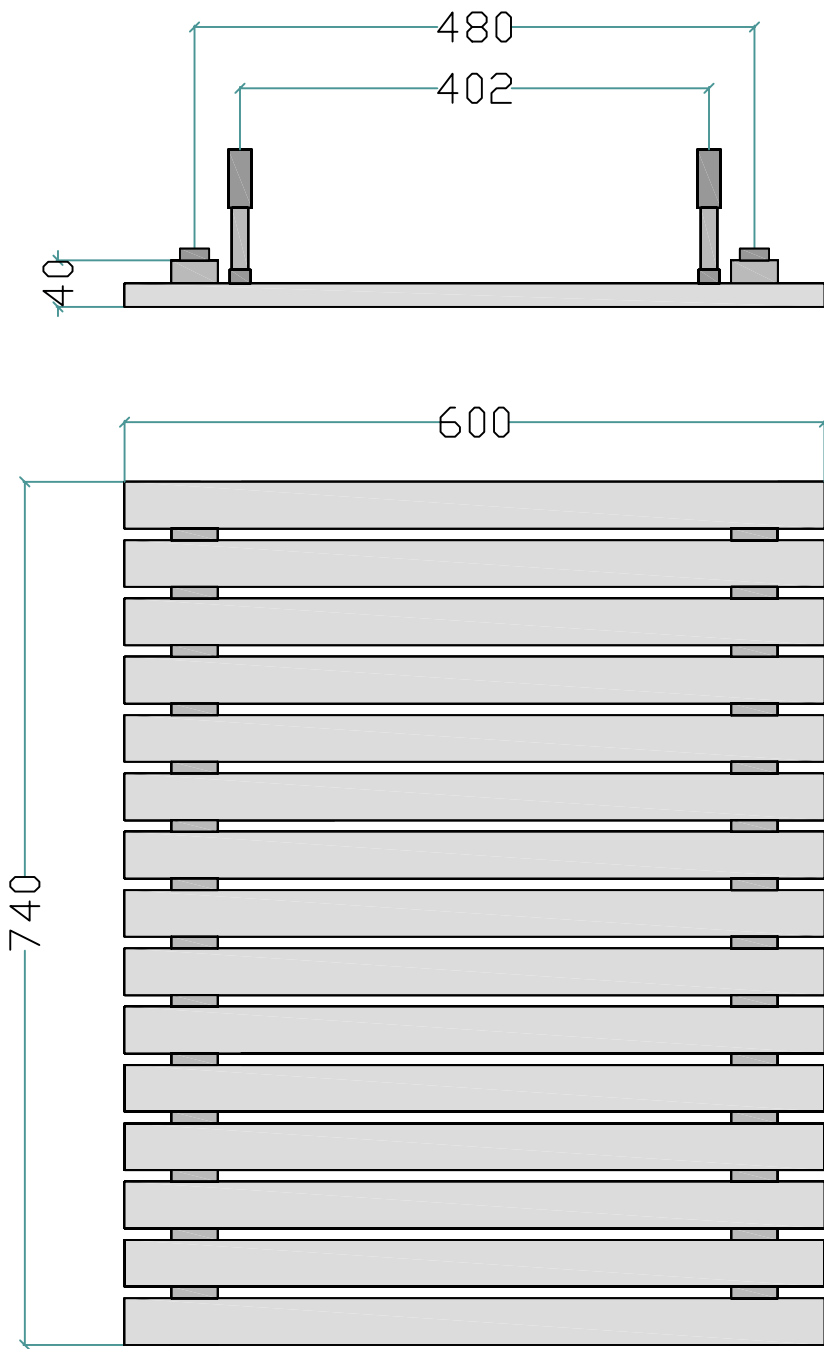

Watt	741
BTU	2.527
kcal / h	637

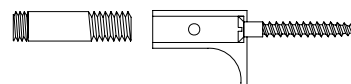
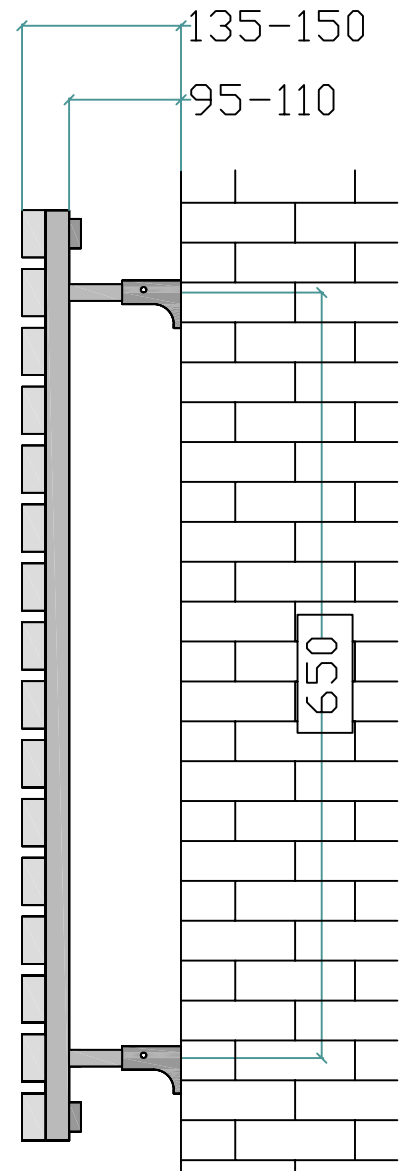
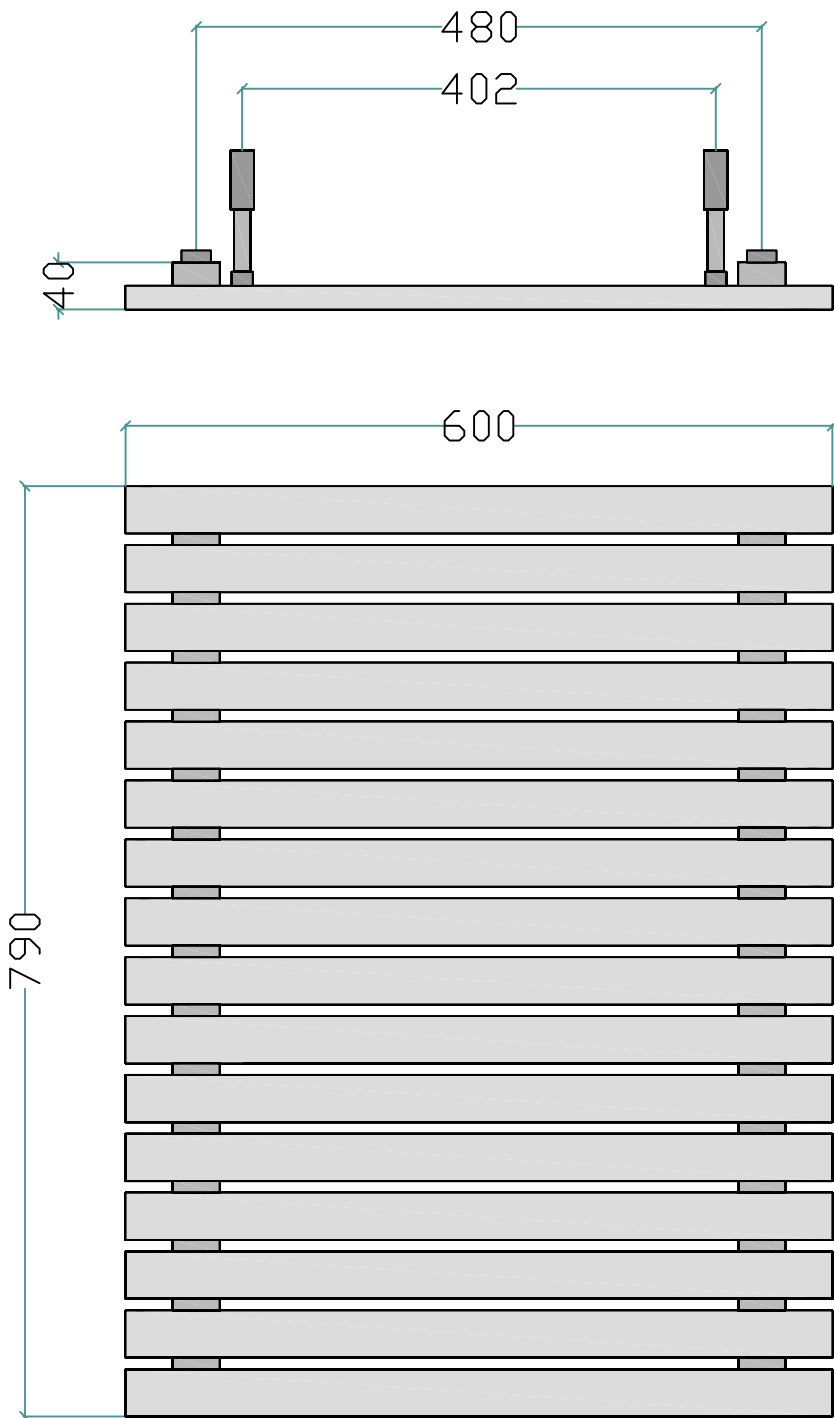

Watt	790
BTU	2.696
kcal / h	679

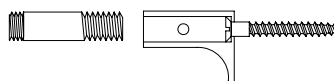
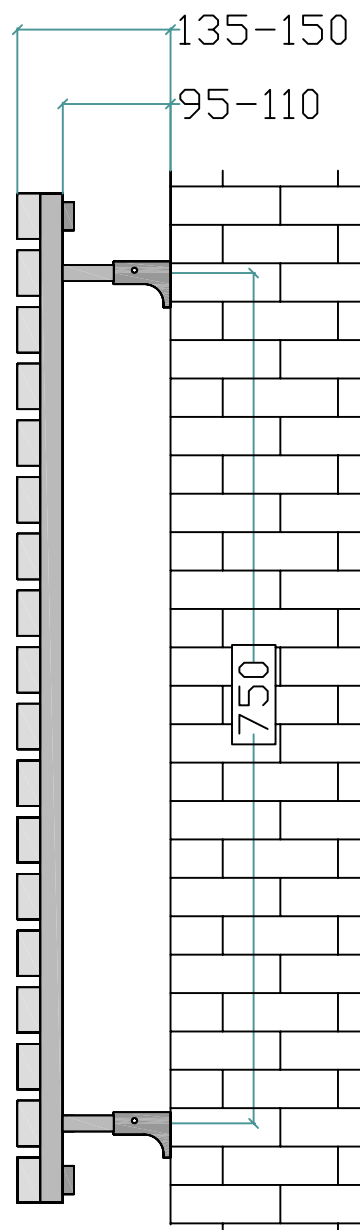
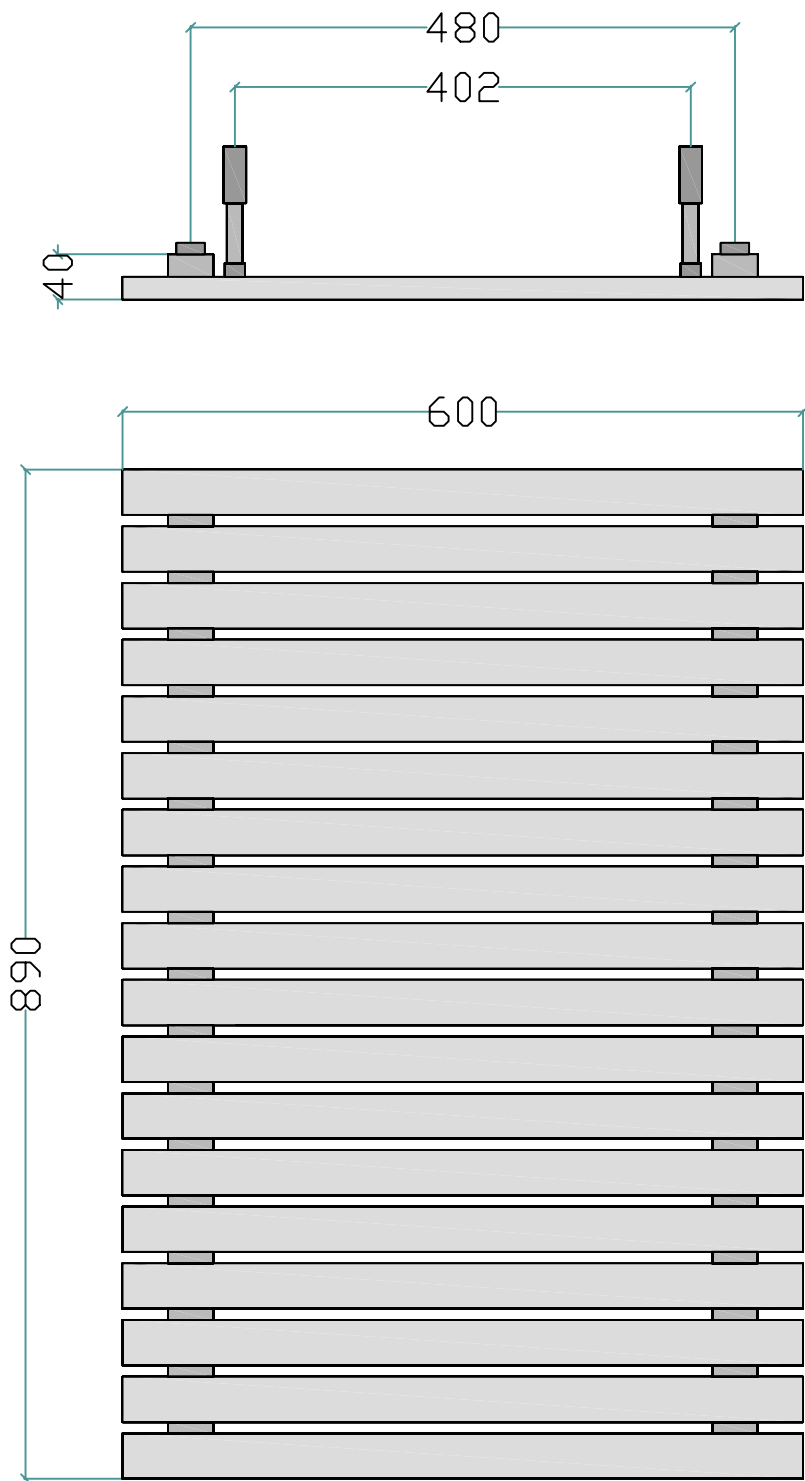

Watt	889
BTU	3.033
kcal / h	764

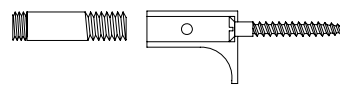
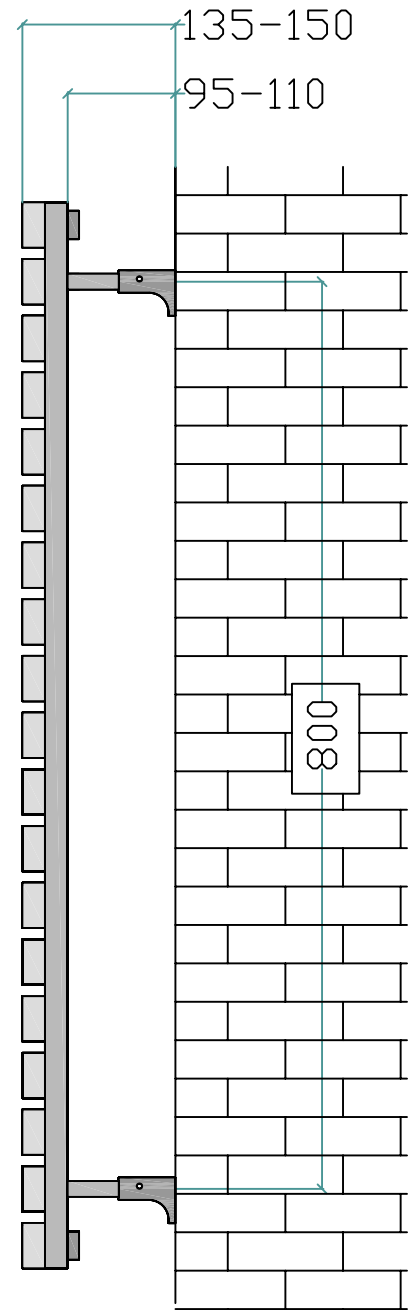
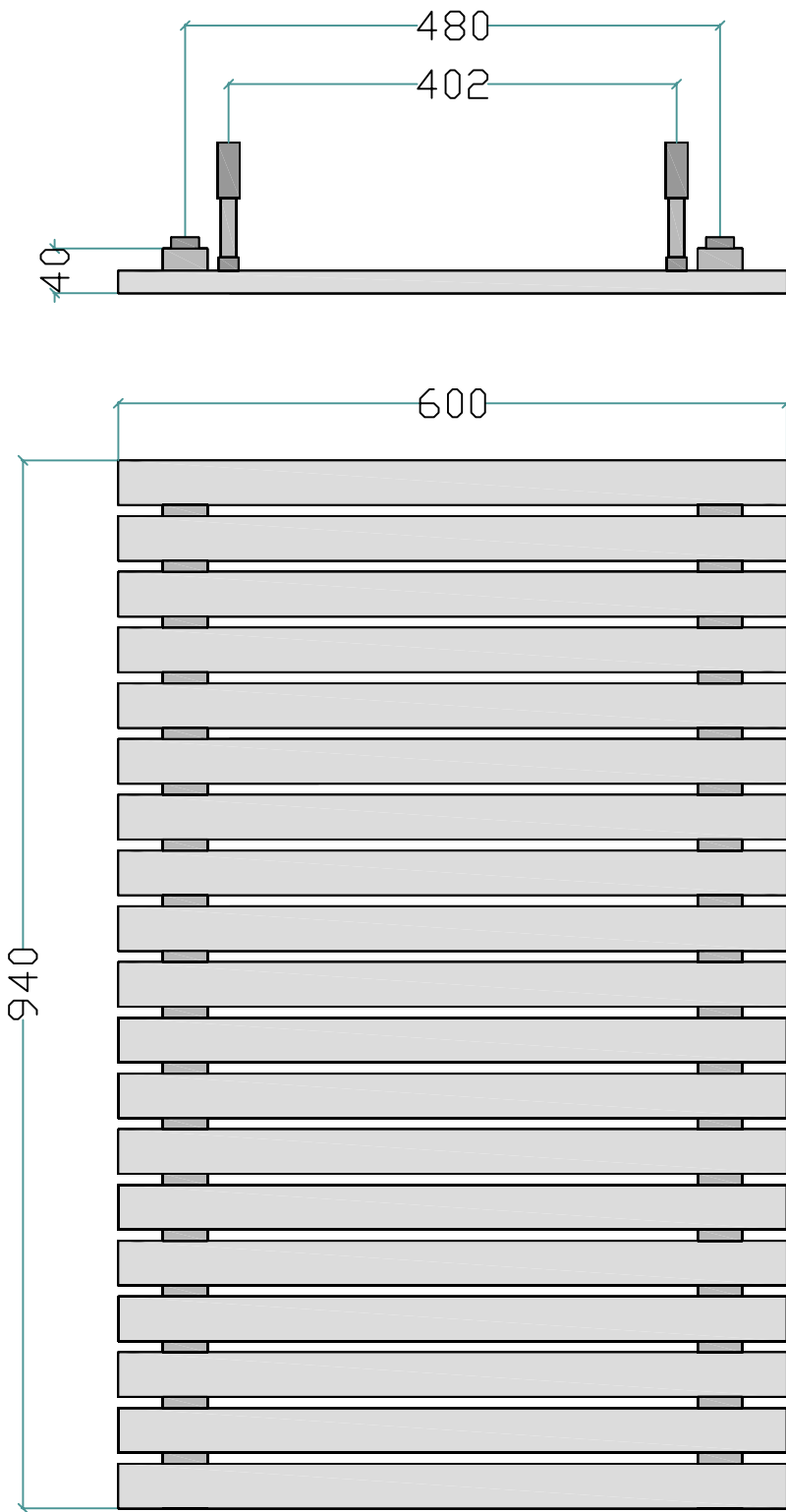

Watt	938
BTU	3.201
kcal / h	807

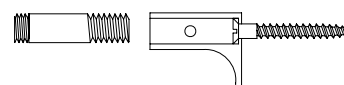
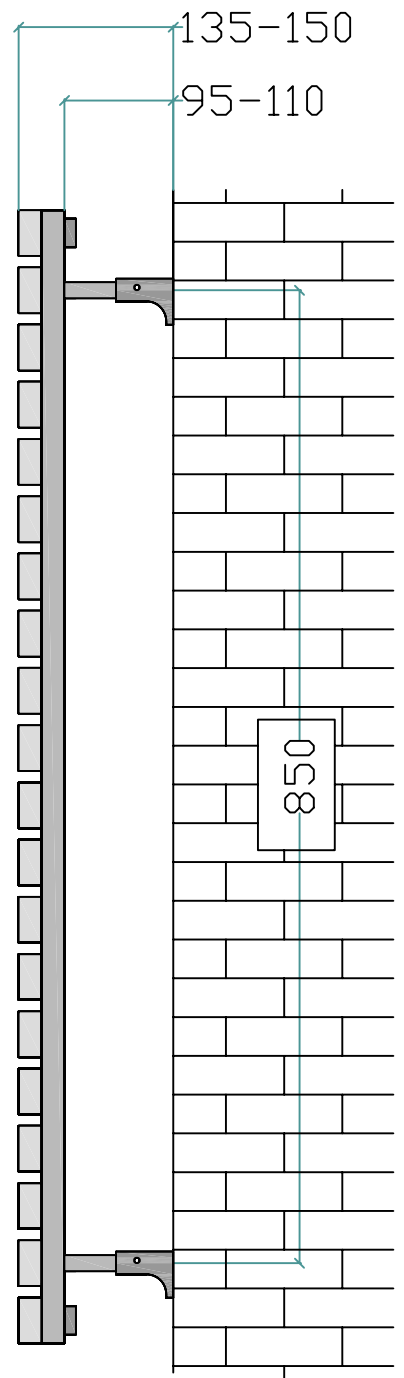
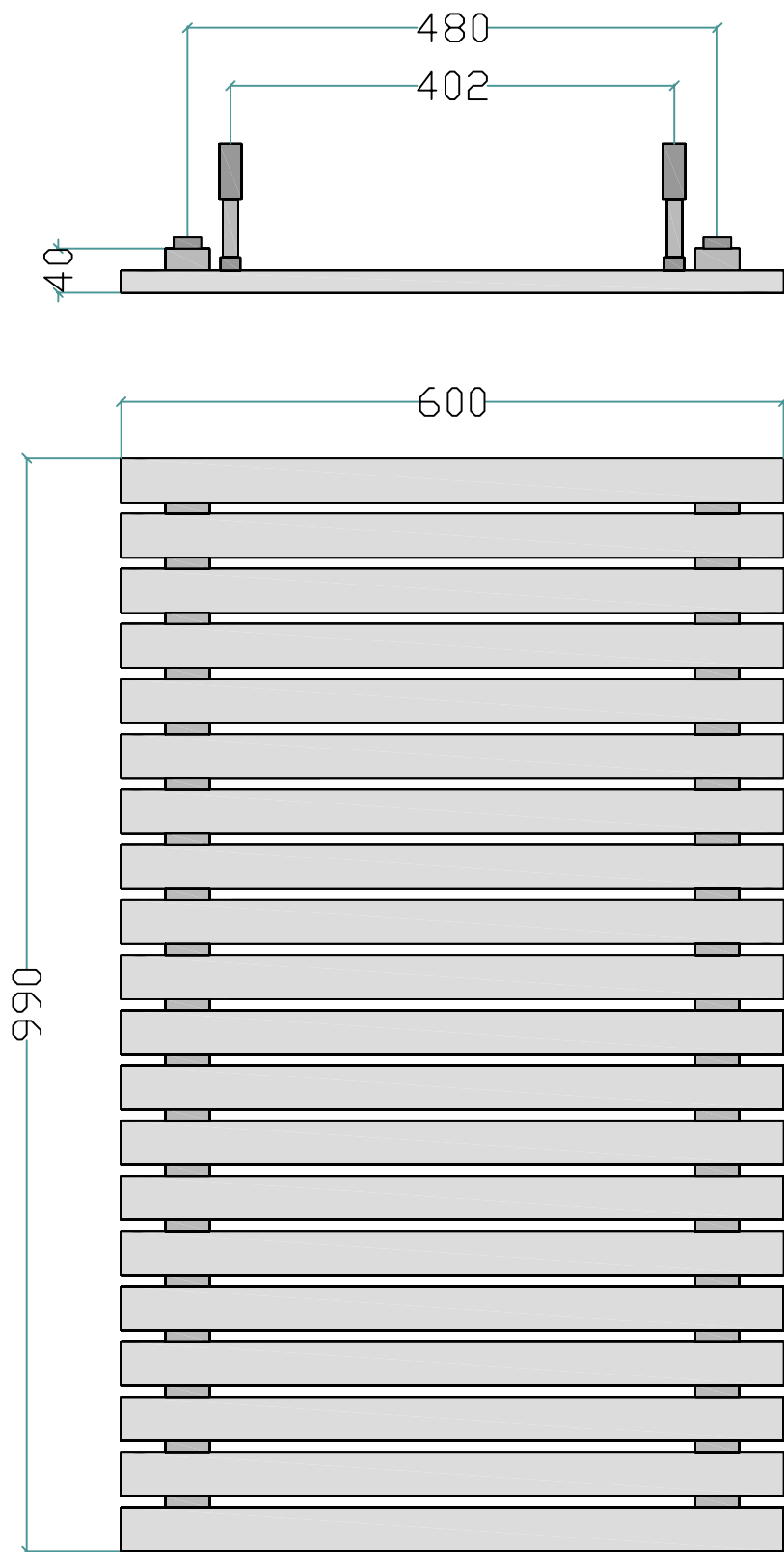

Watt	988
BTU	3.370
kcal / h	849

Dune 60 / 20

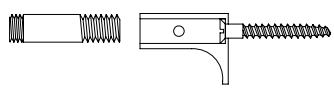
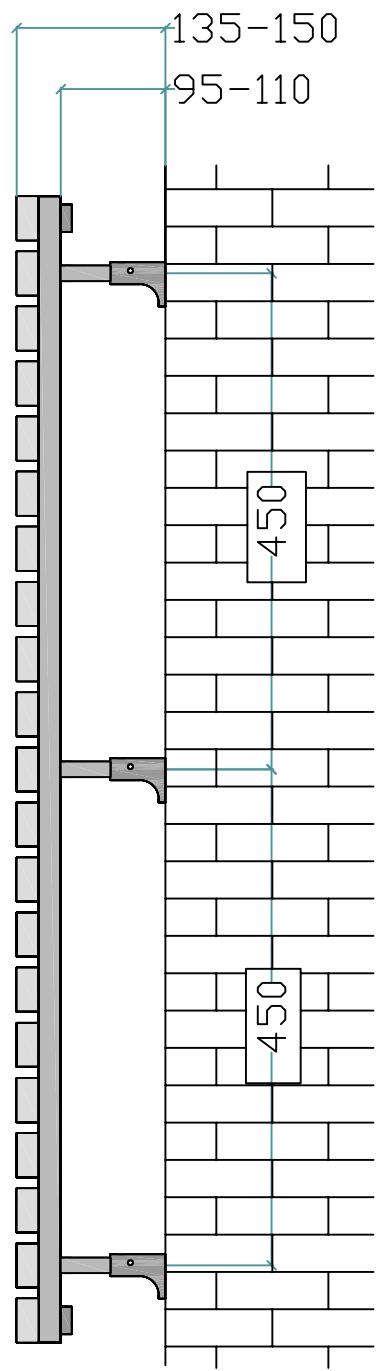
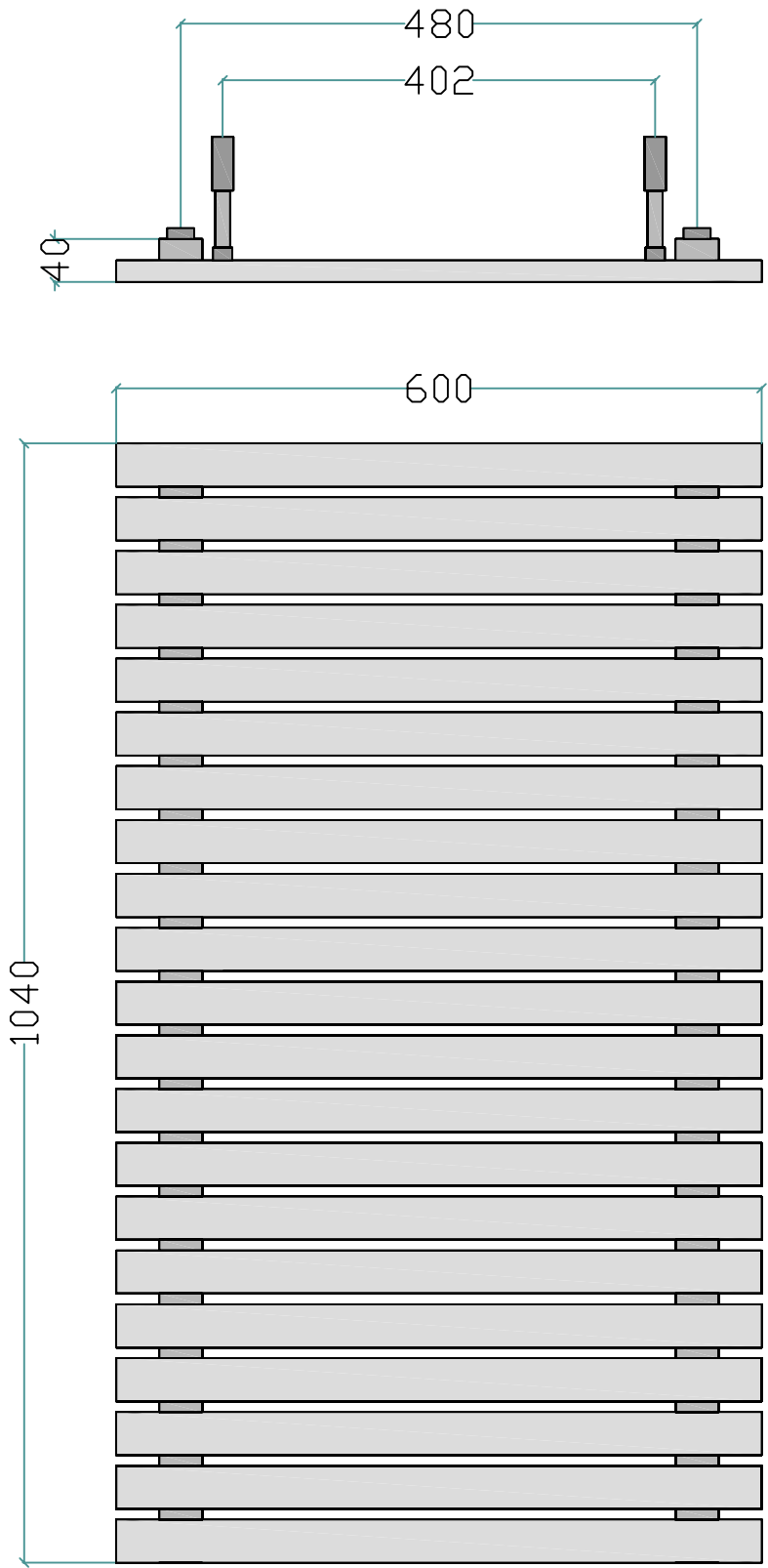

Watt	1.037
BTU	3.538
kcal / h	892

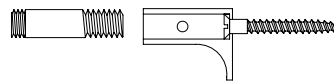
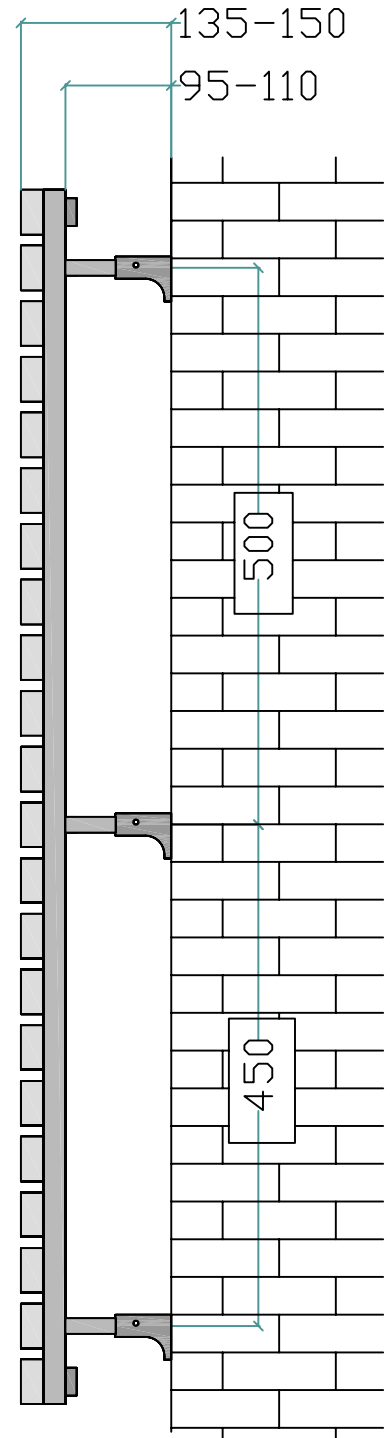
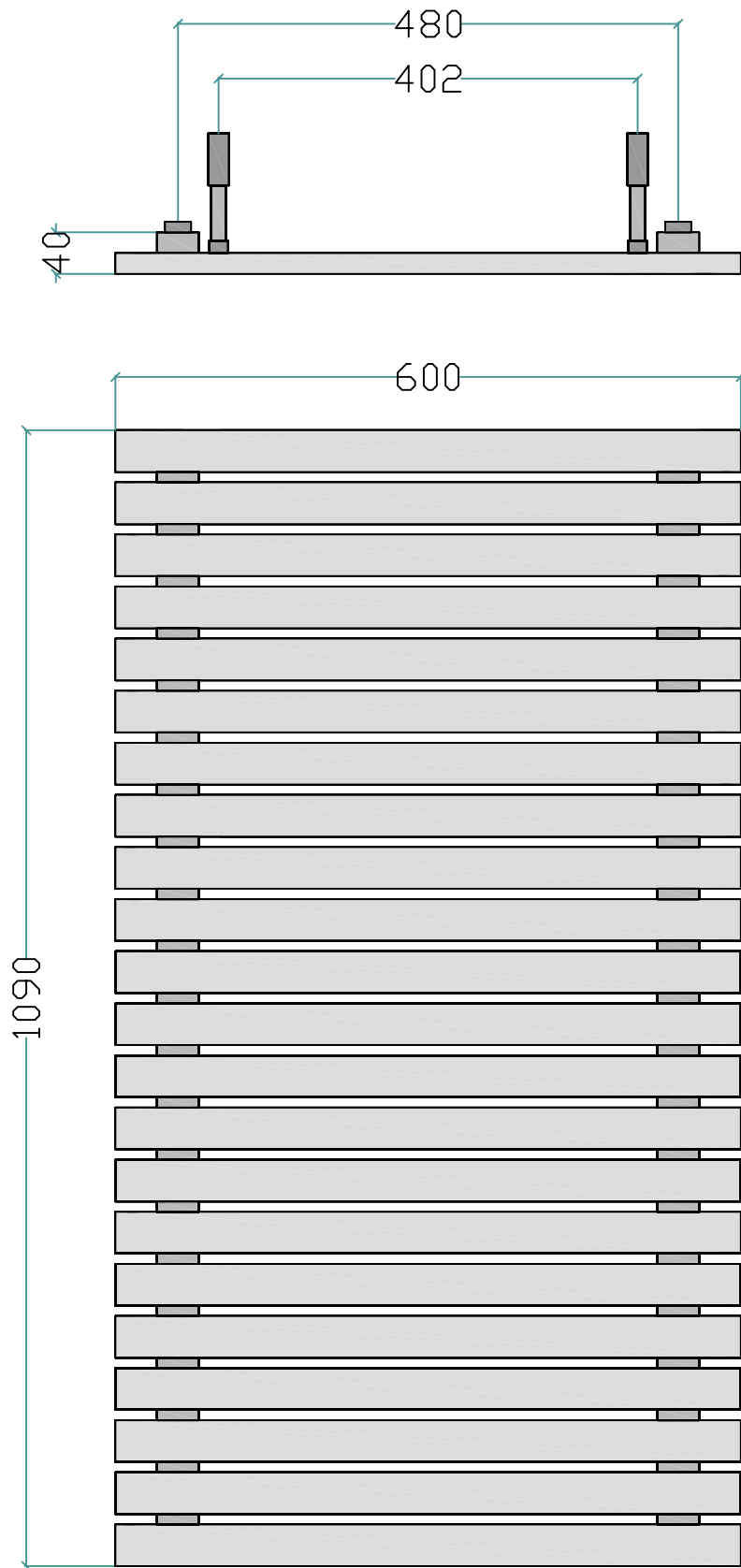

Watt	1.086
BTU	3.707
kcal / h	934

Dune 60 / 22

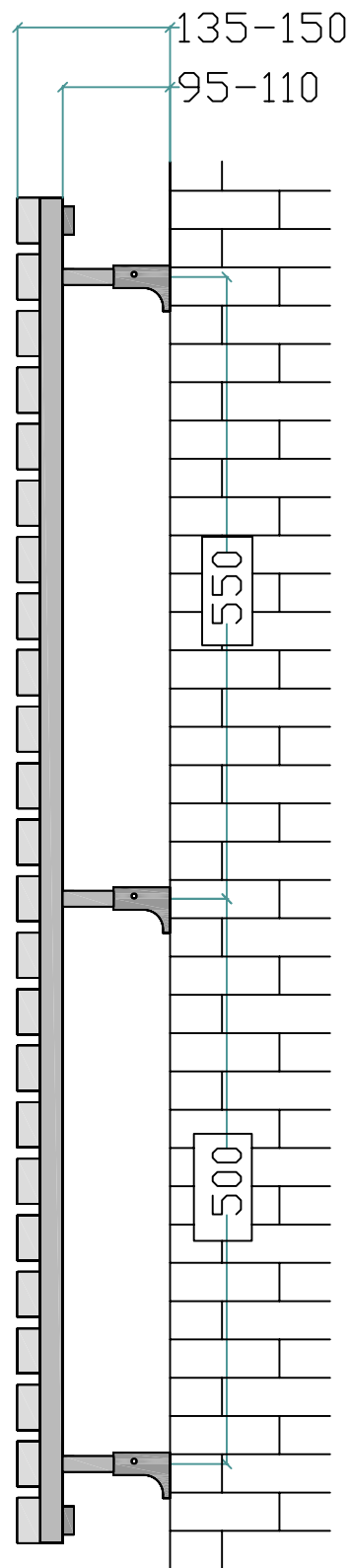
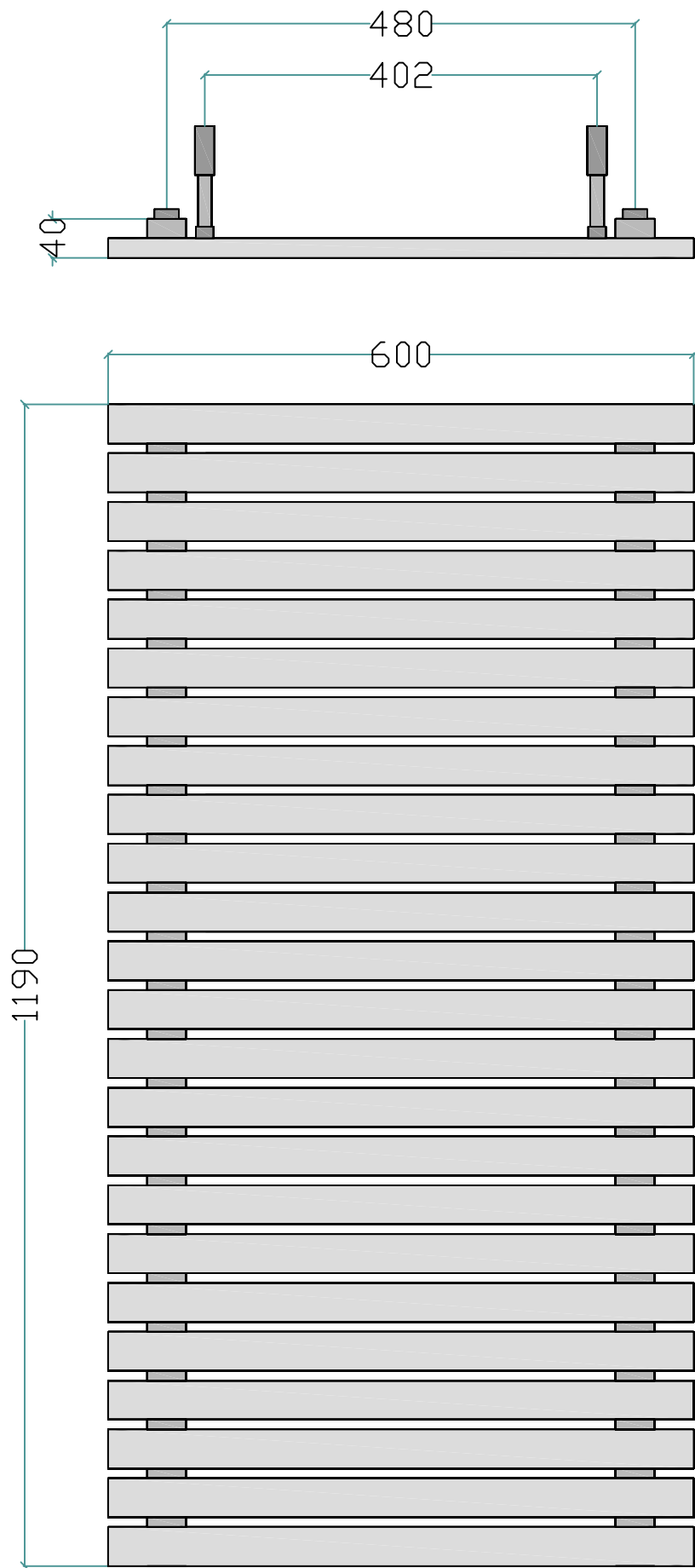

Watt	1.185
BTU	4.044
kcal / h	1.019

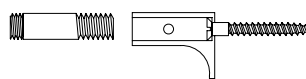

Dune 60 / 24

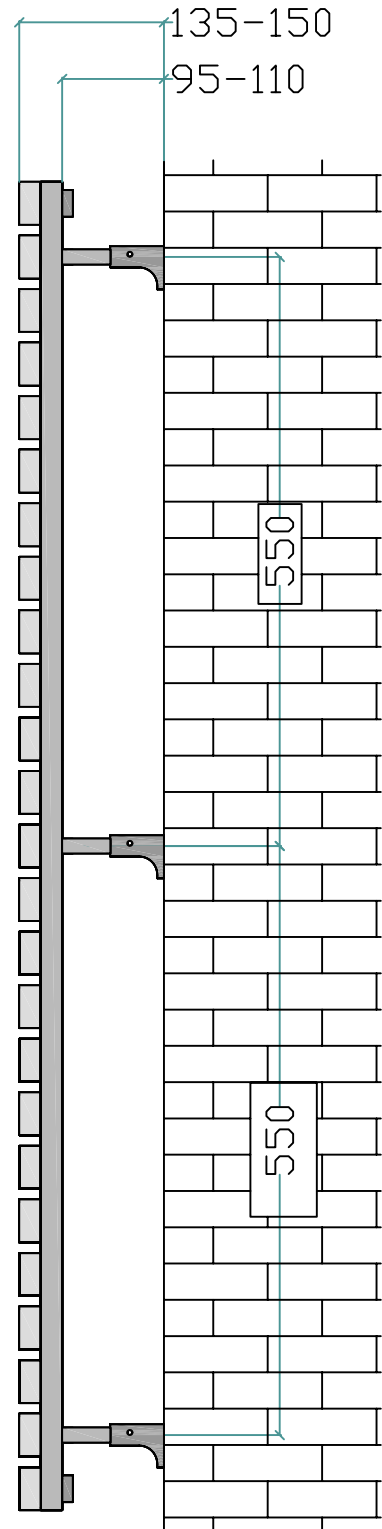
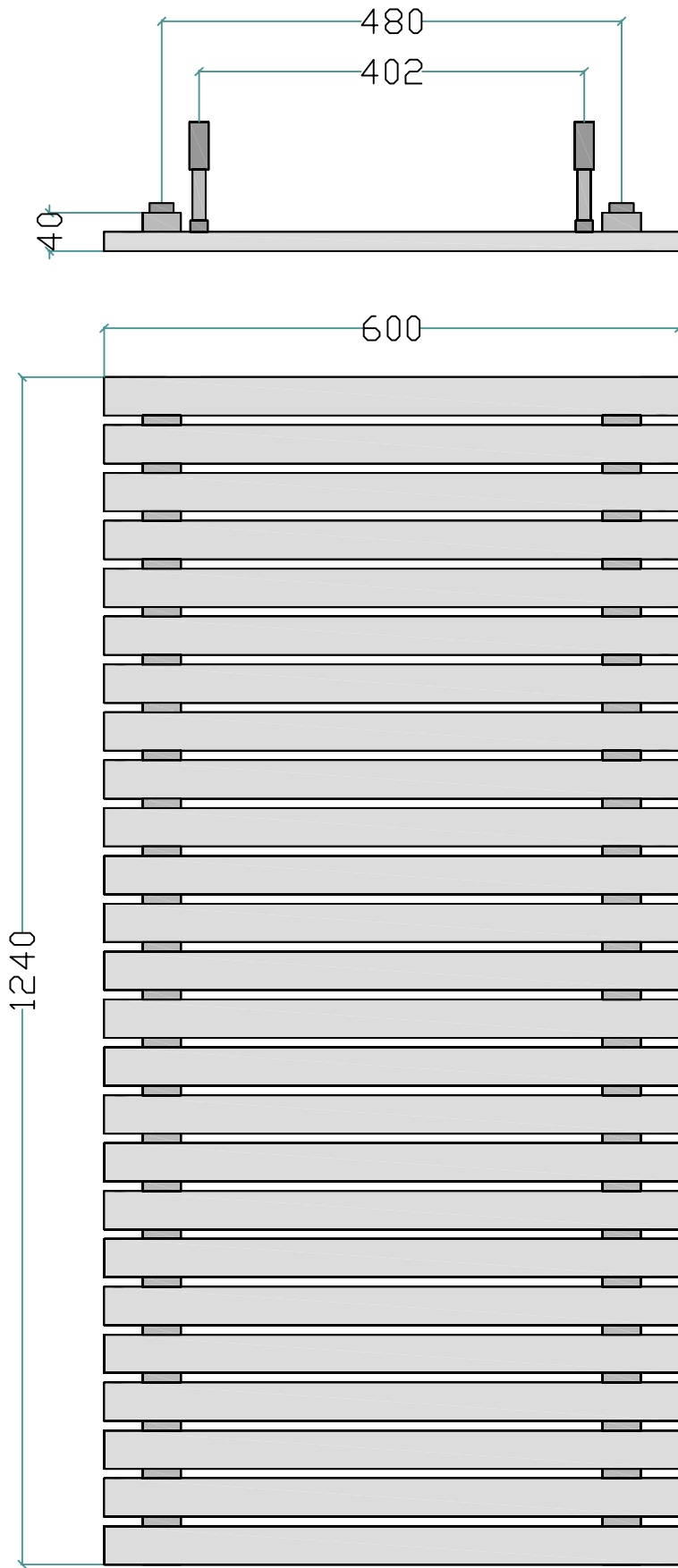

Watt	1.235
BTU	4.212
kcal / h	1.061

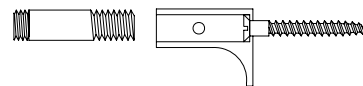

Dune 60 / 25

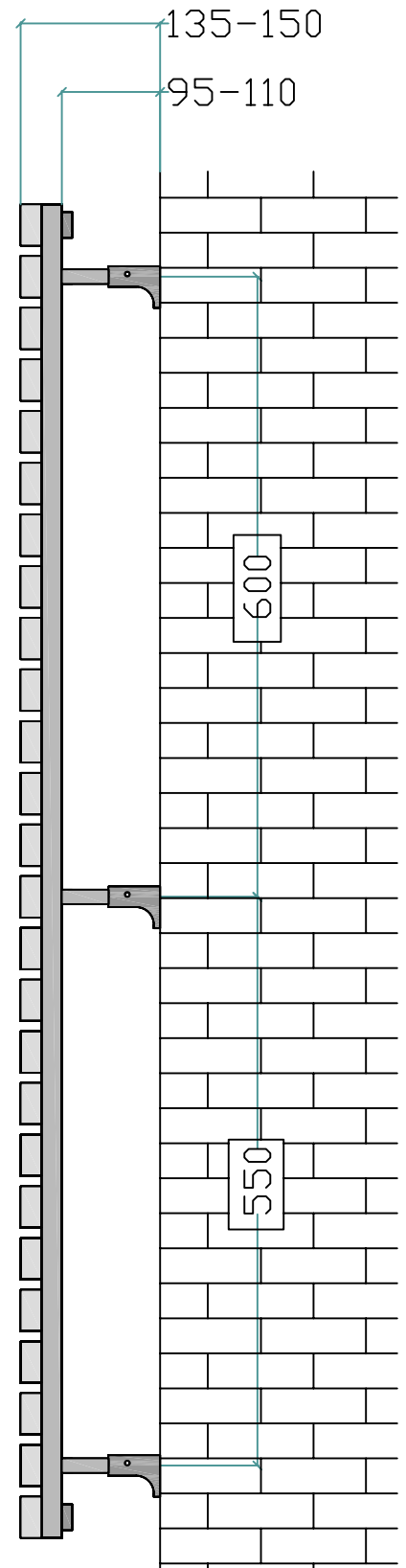
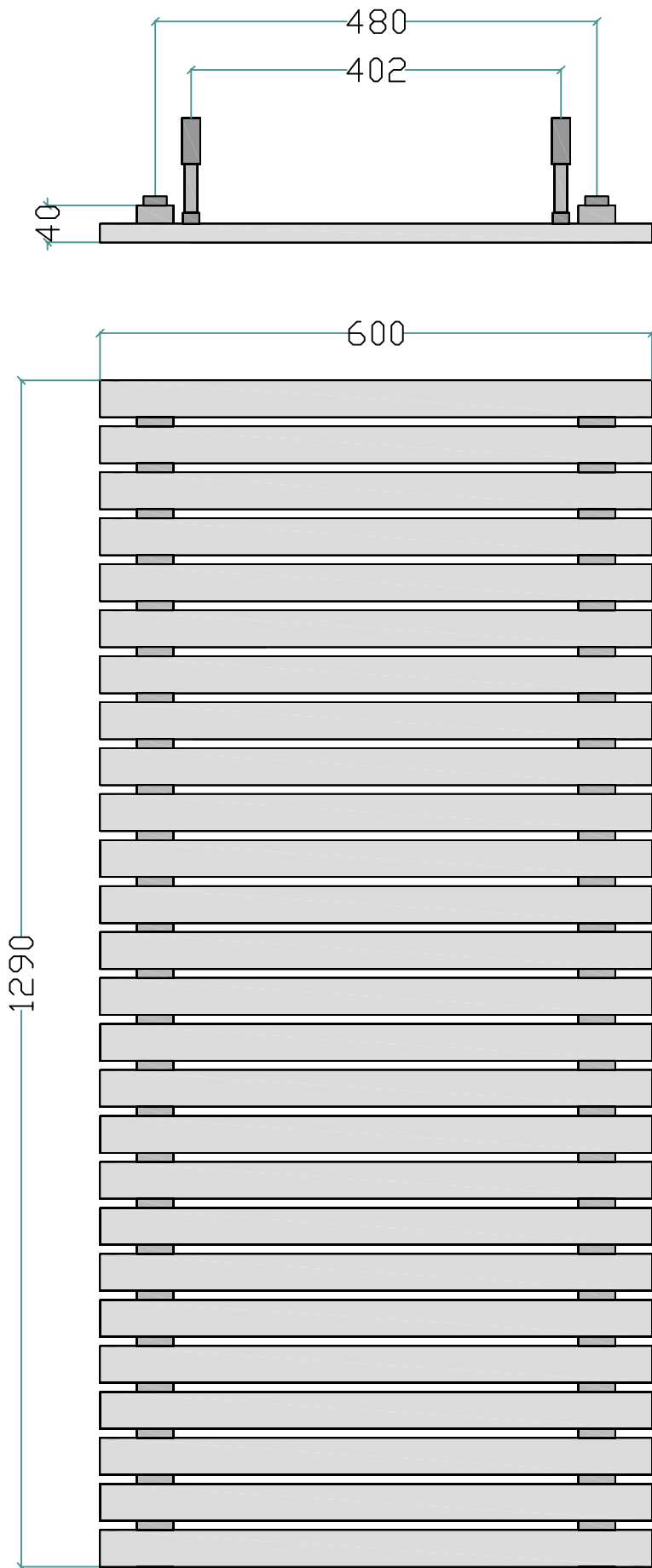

Watt	1.284
BTU	4.381
kcal / h	1.104

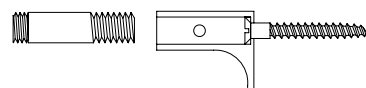

Dune 60 / 26

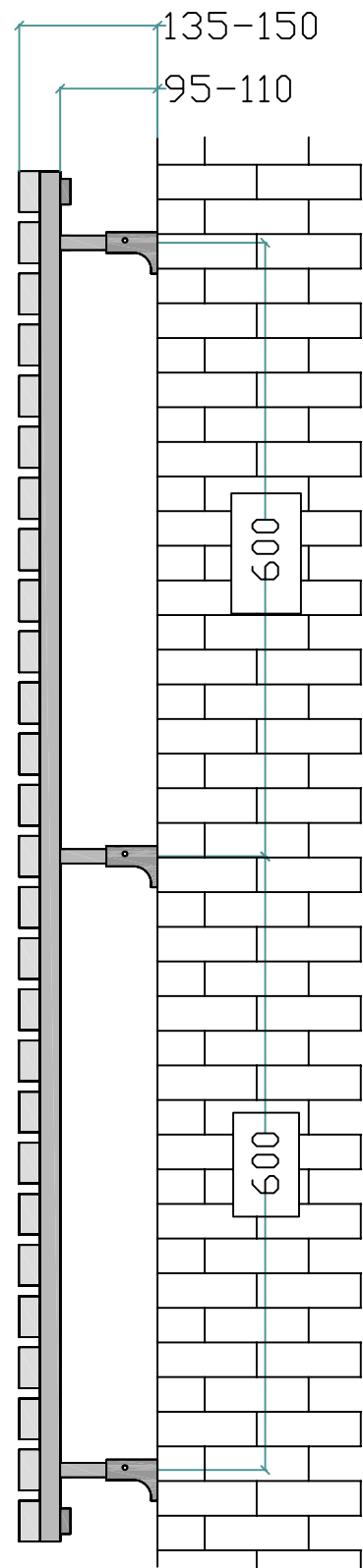
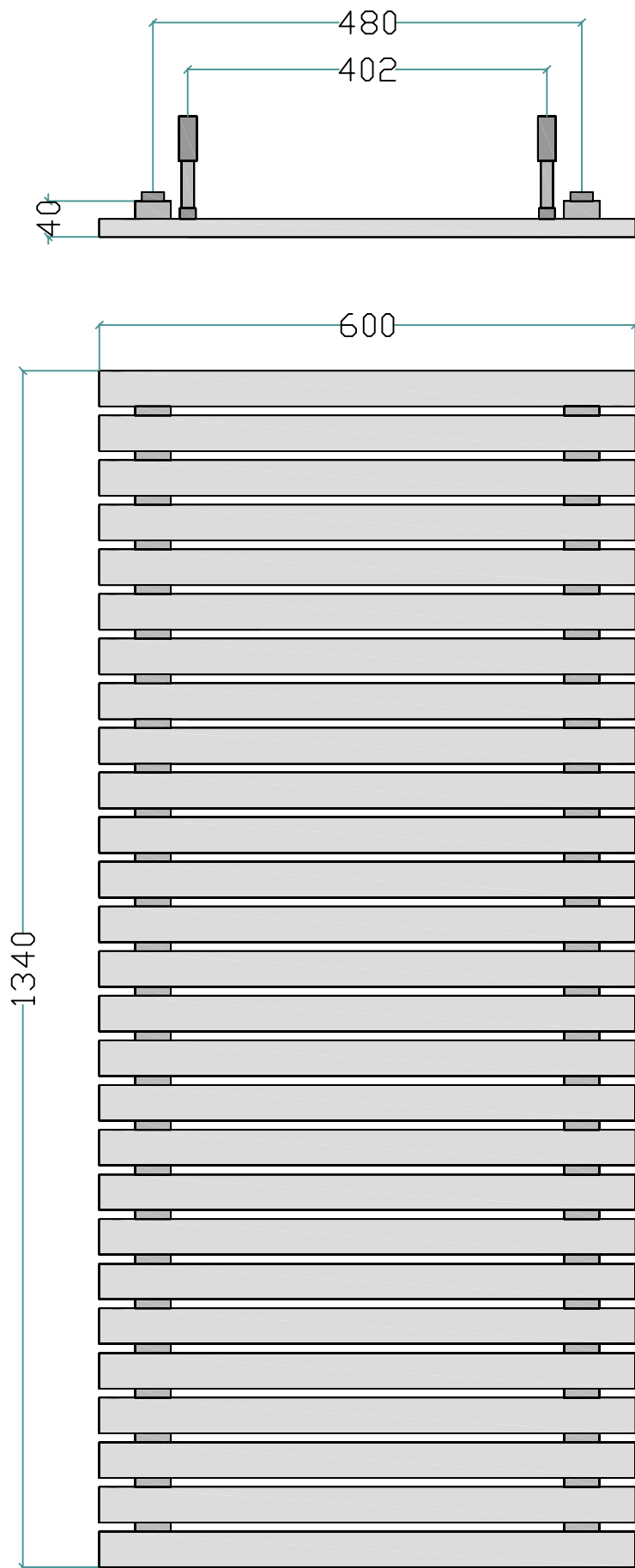

Watt	1.333
BTU	4.549
kcal / h	1.146

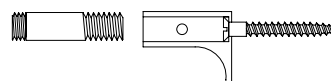

Dune 60 / 27

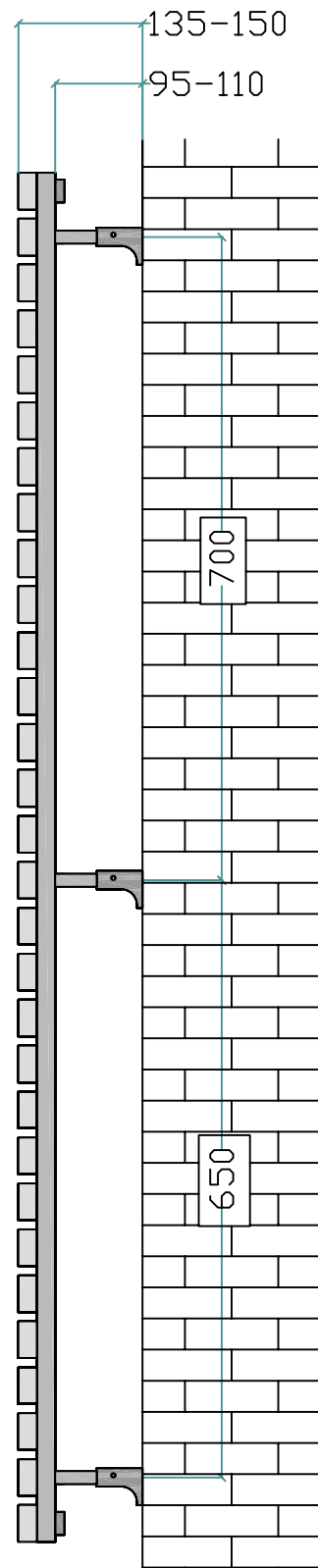
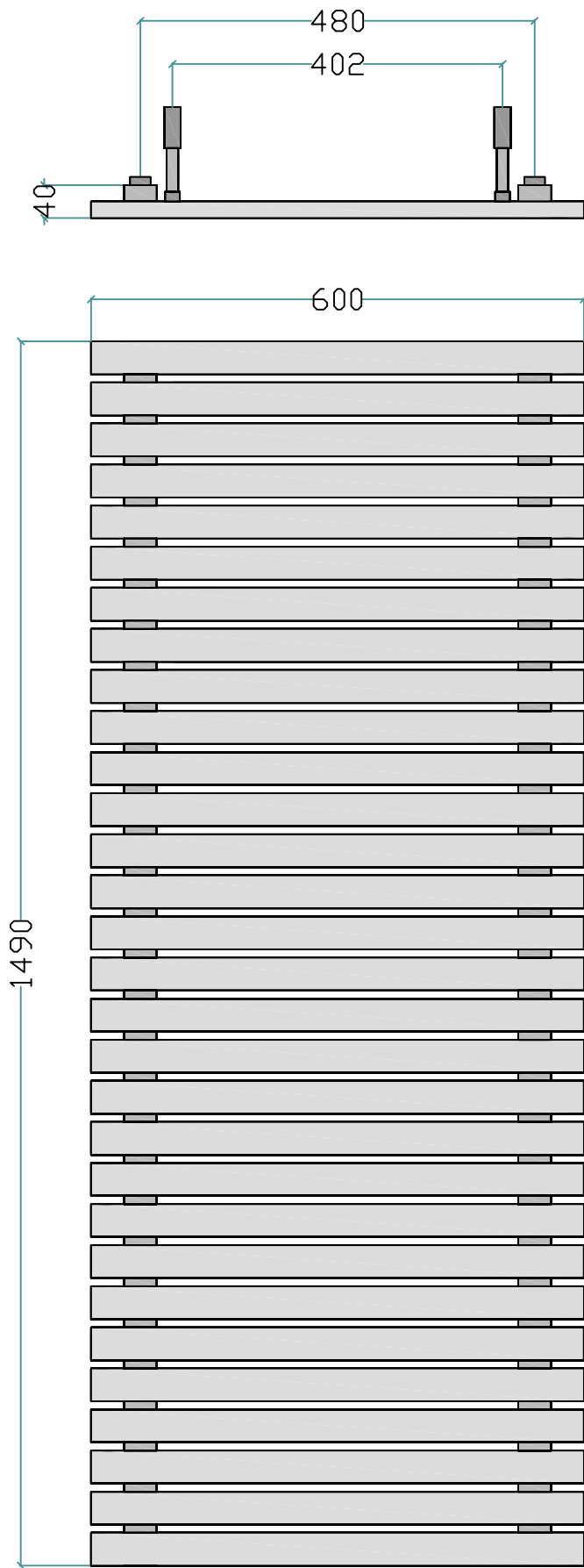

Watt	1.481
BTU	5.055
kcal / h	1.274

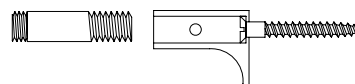

Dune 60 / 30

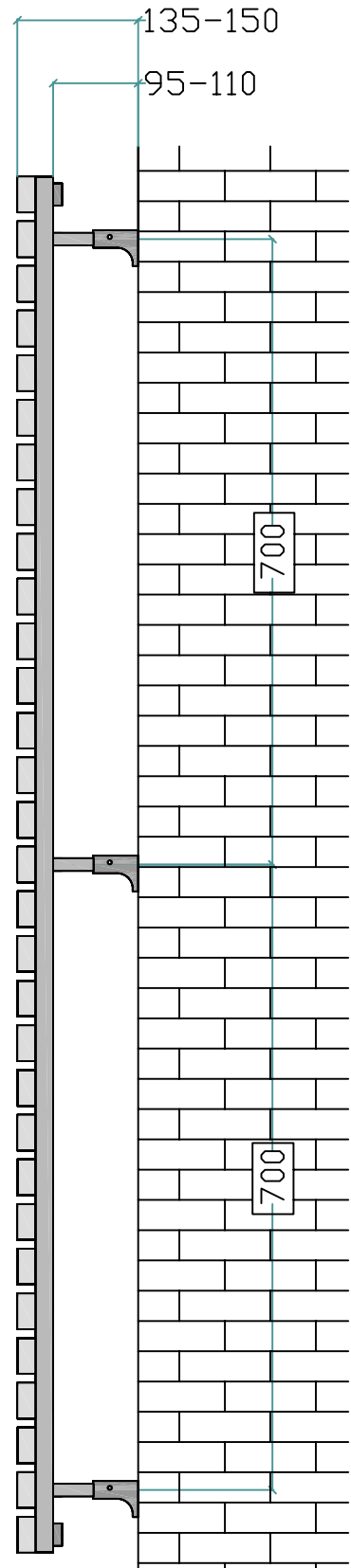
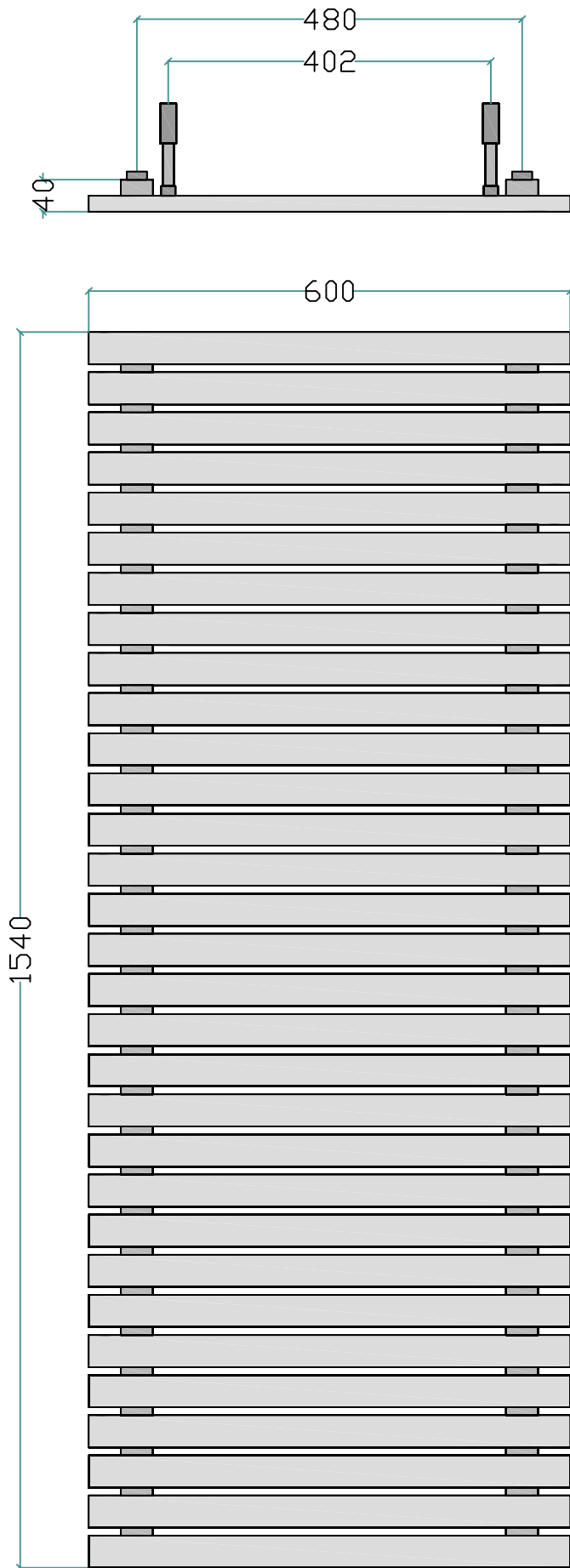

Watt	1.531
BTU	5.223
kcal / h	1.316

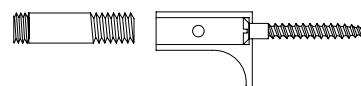

Dune 60 / 31

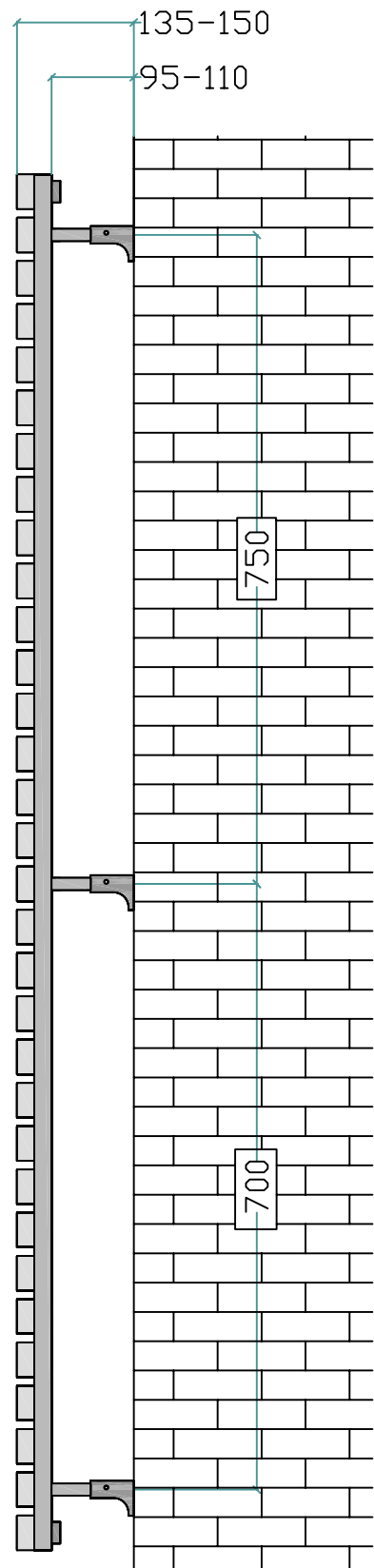
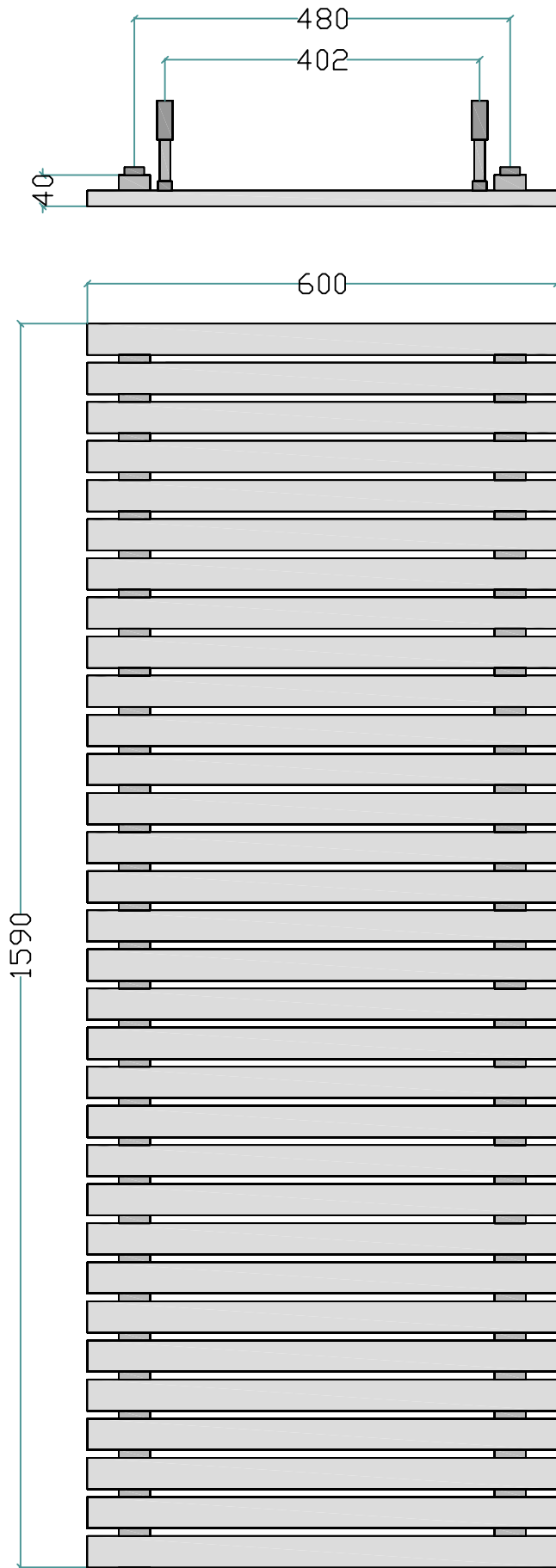

Watt	1.580
BTU	5.392
kcal / h	1.359

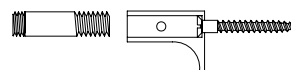

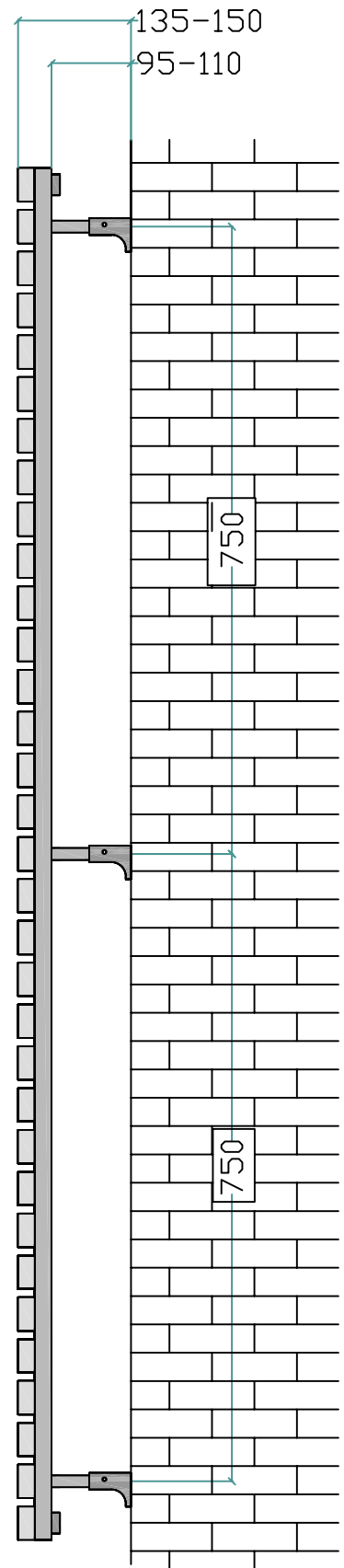
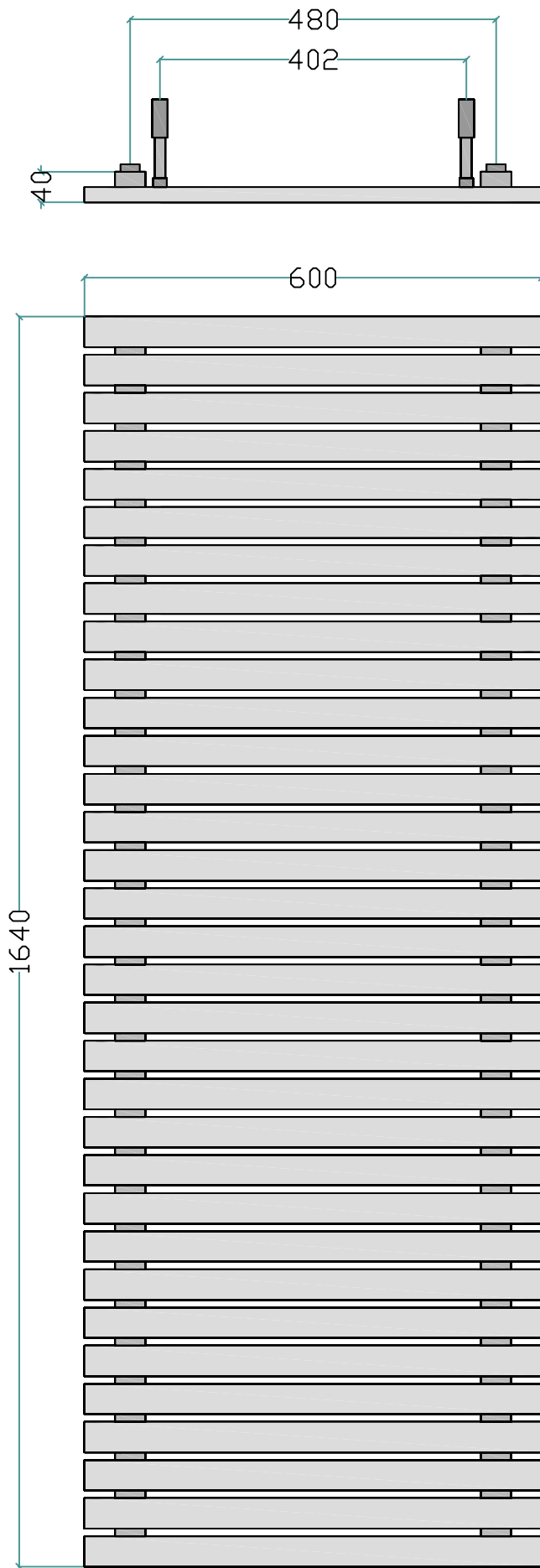

Watt	1.630
BTU	5.560
kcal / h	1.401

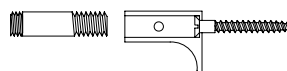

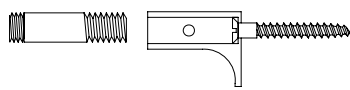
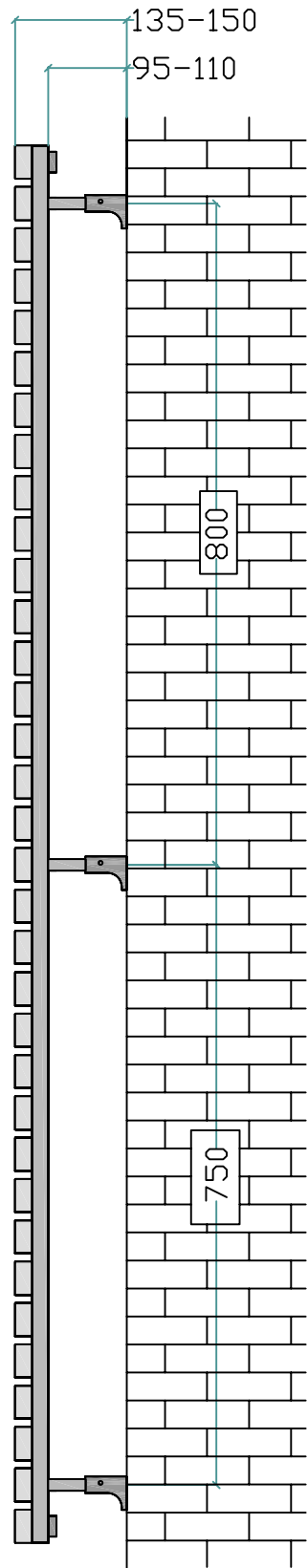
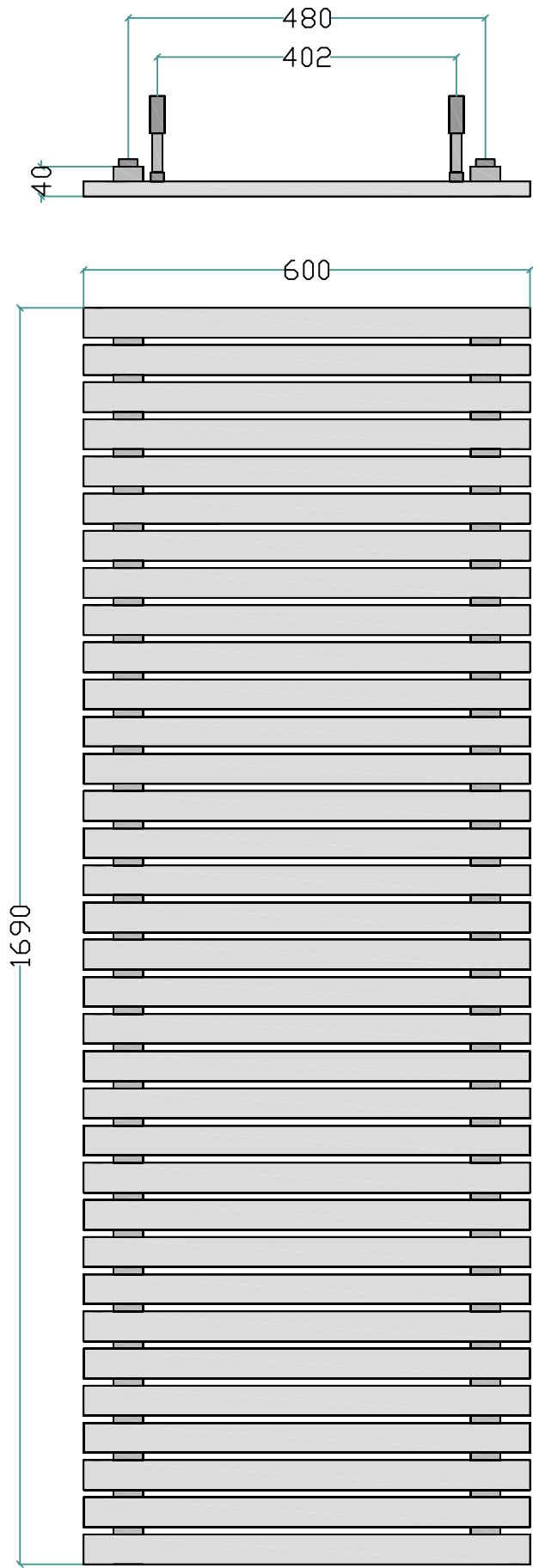

Watt	1.679
BTU	5.729
kcal / h	1.444

Dune 60 / 34

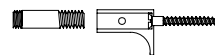
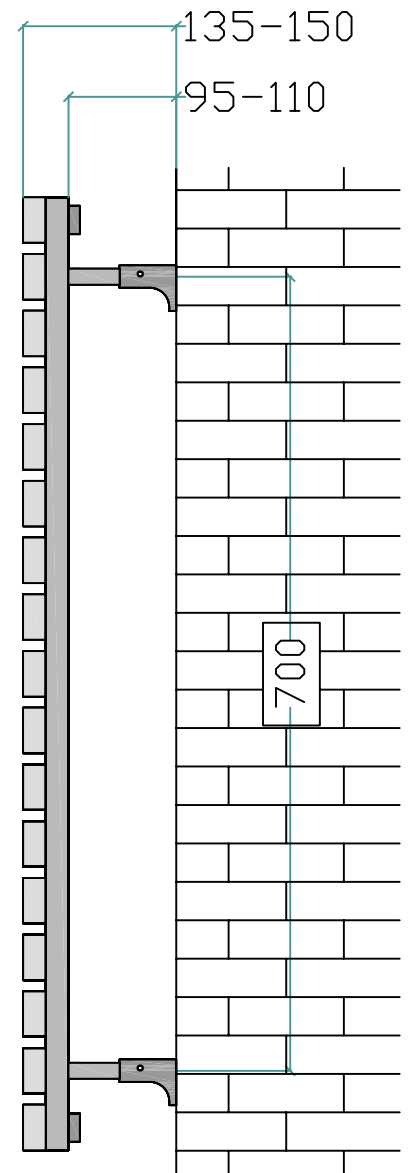
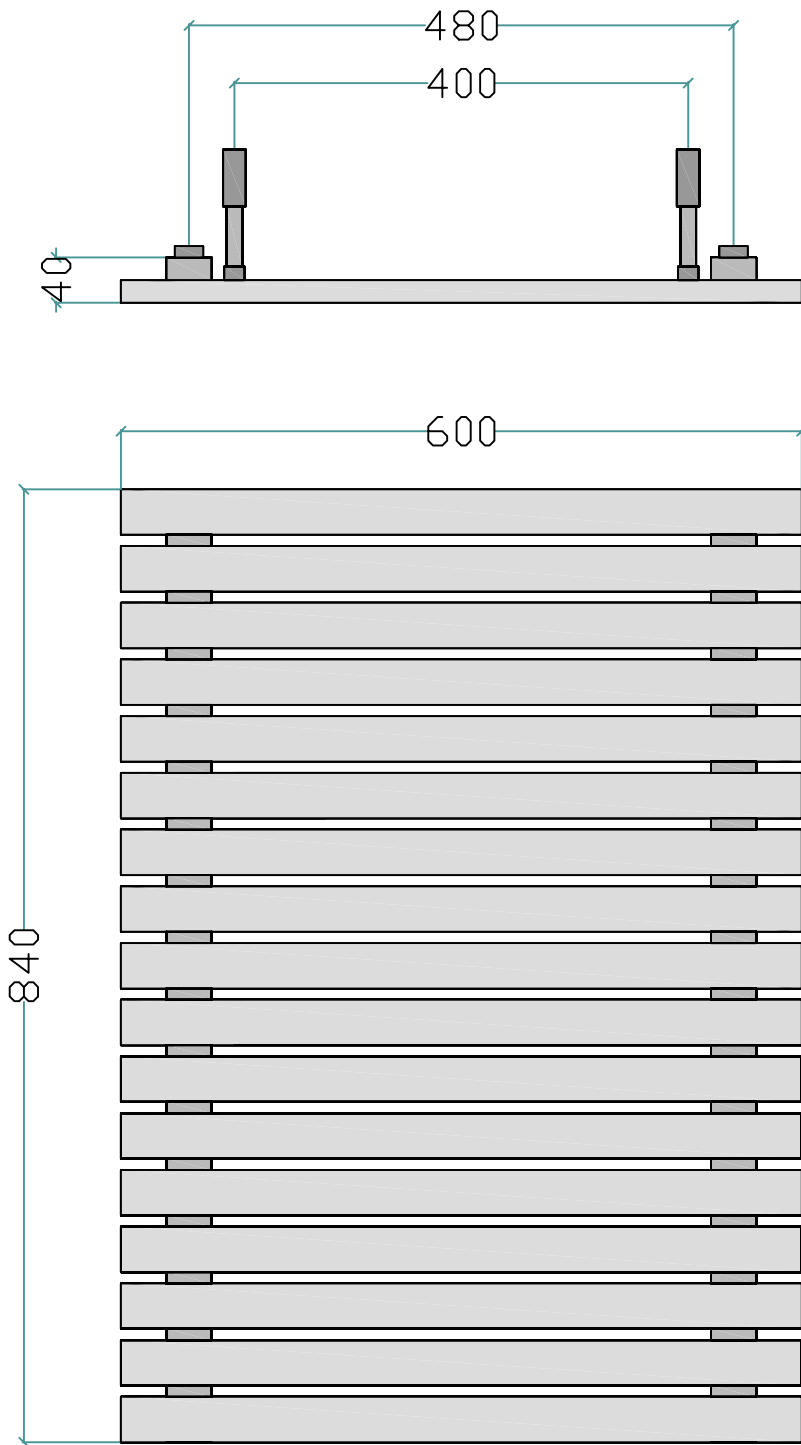

Watt	839
BTU	2.864
kcal / h	722

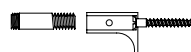
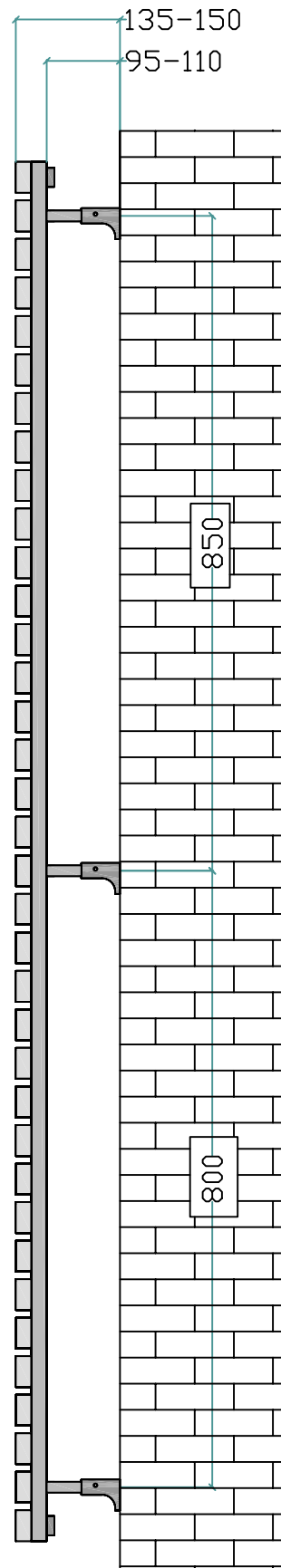
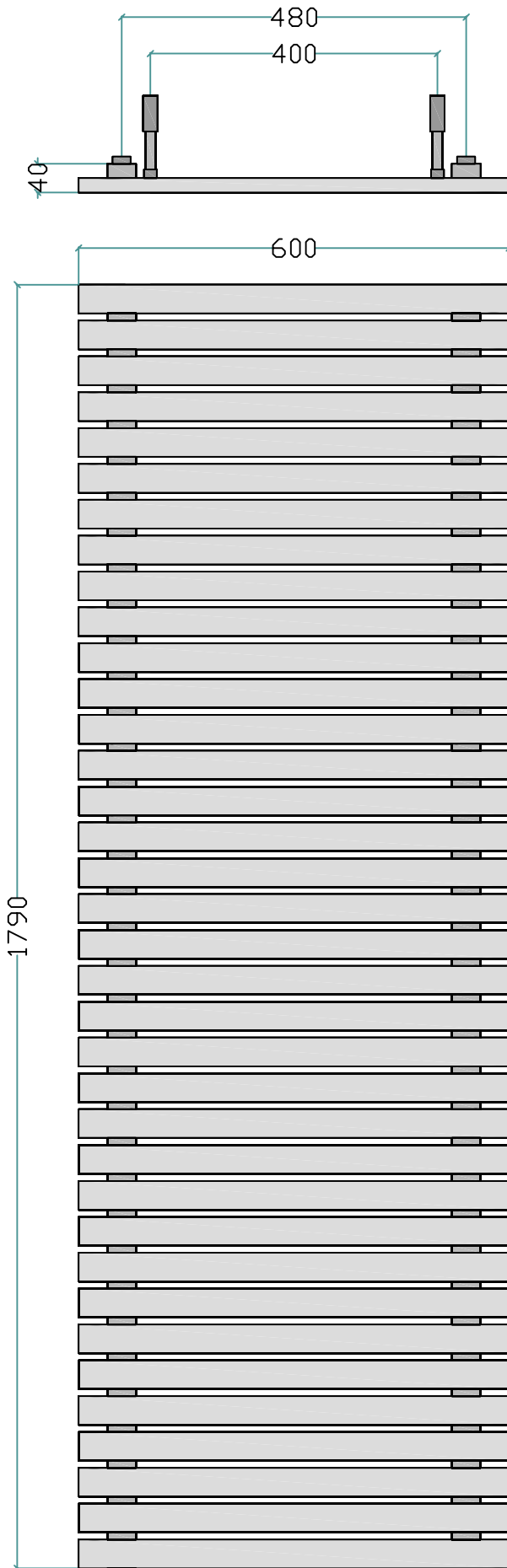

Watt	1.778
BTU	6.066
kcal / h	1.528

Dune 60 / 36

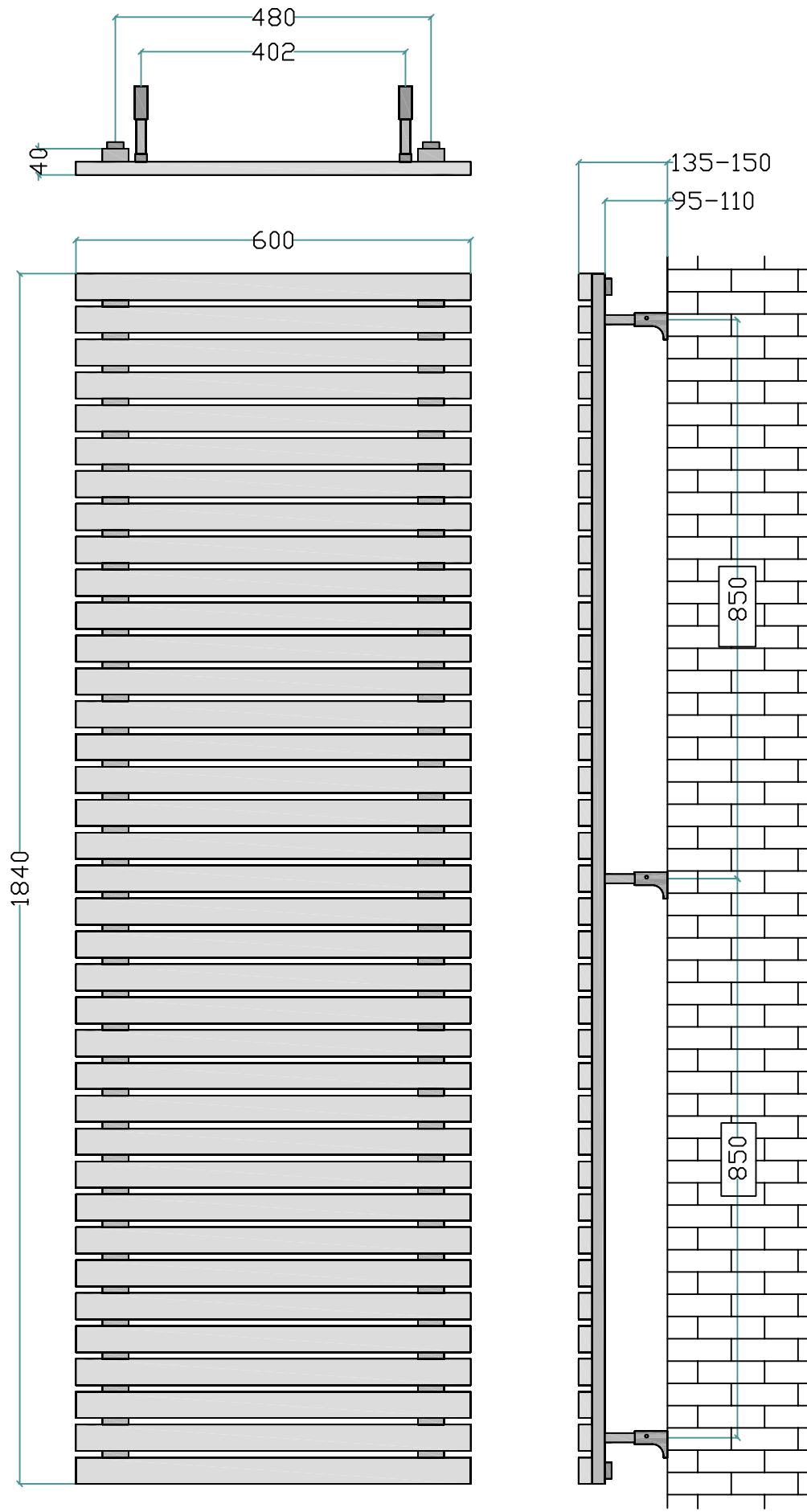

Watt	1.827
BTU	6.234
kcal / h	1.571

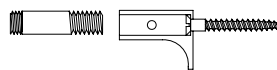

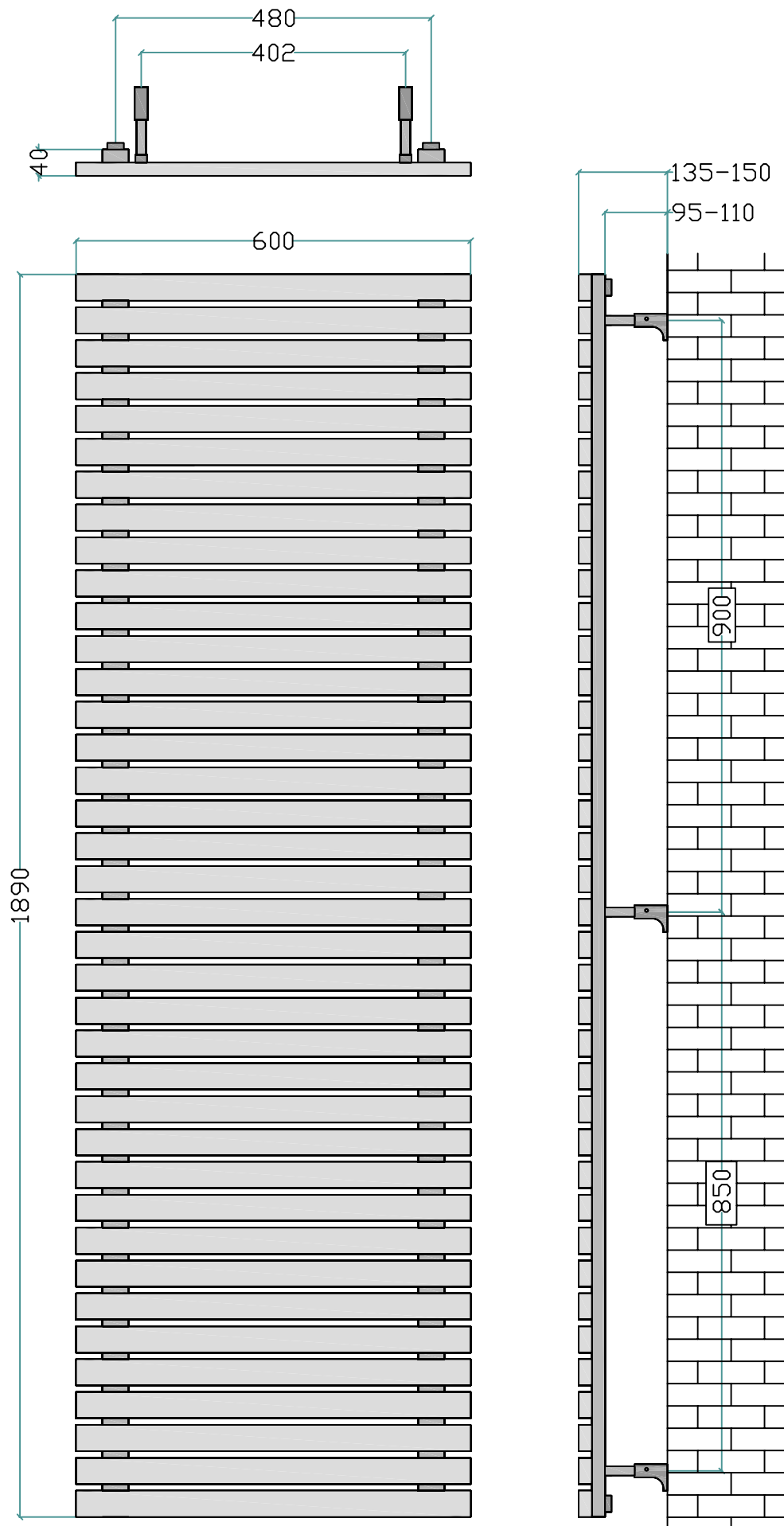

Watt	1.876
BTU	6.403
kcal / h	1.613

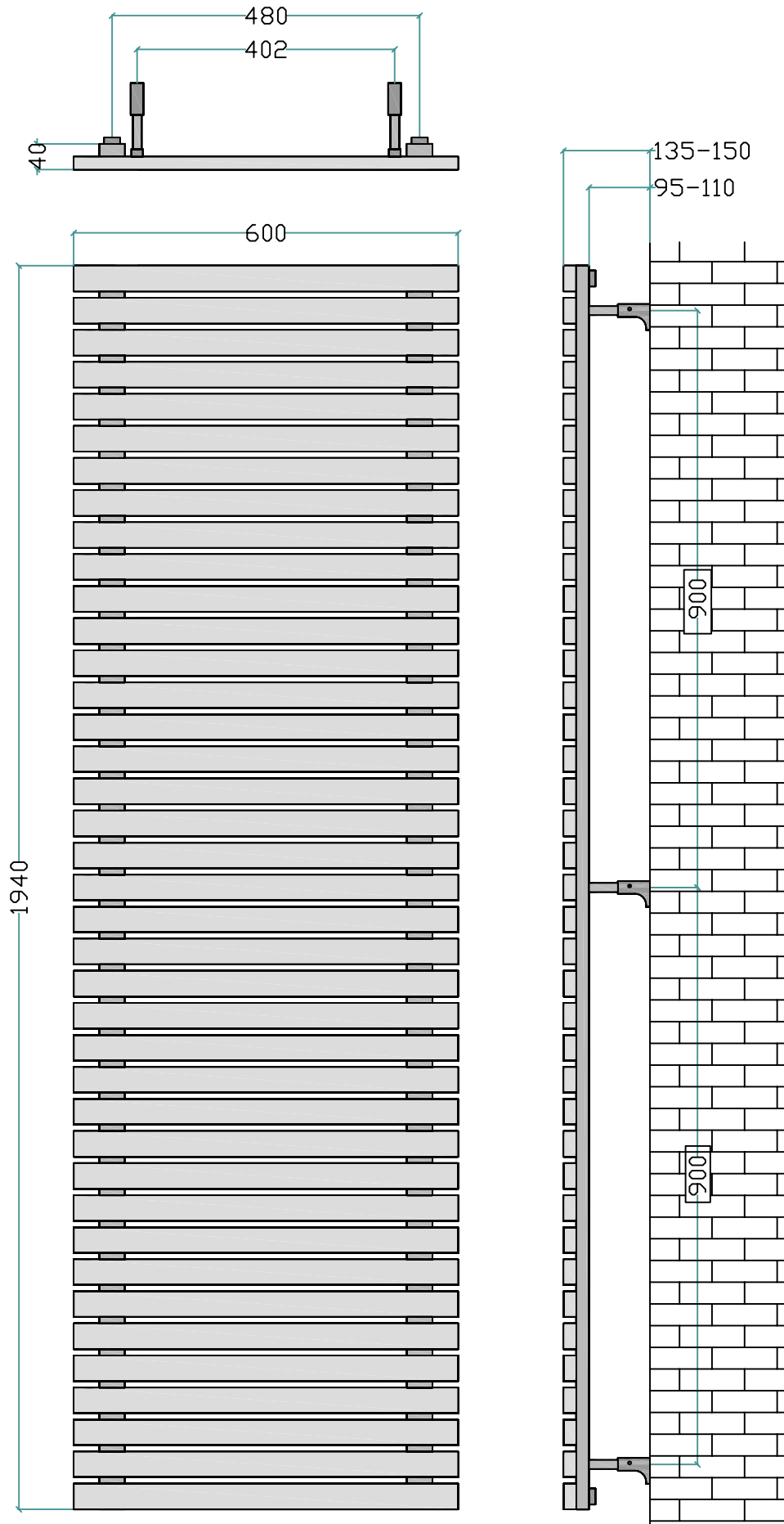

Watt	1.926
BTU	6.571
kcal / h	1.656

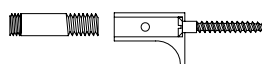

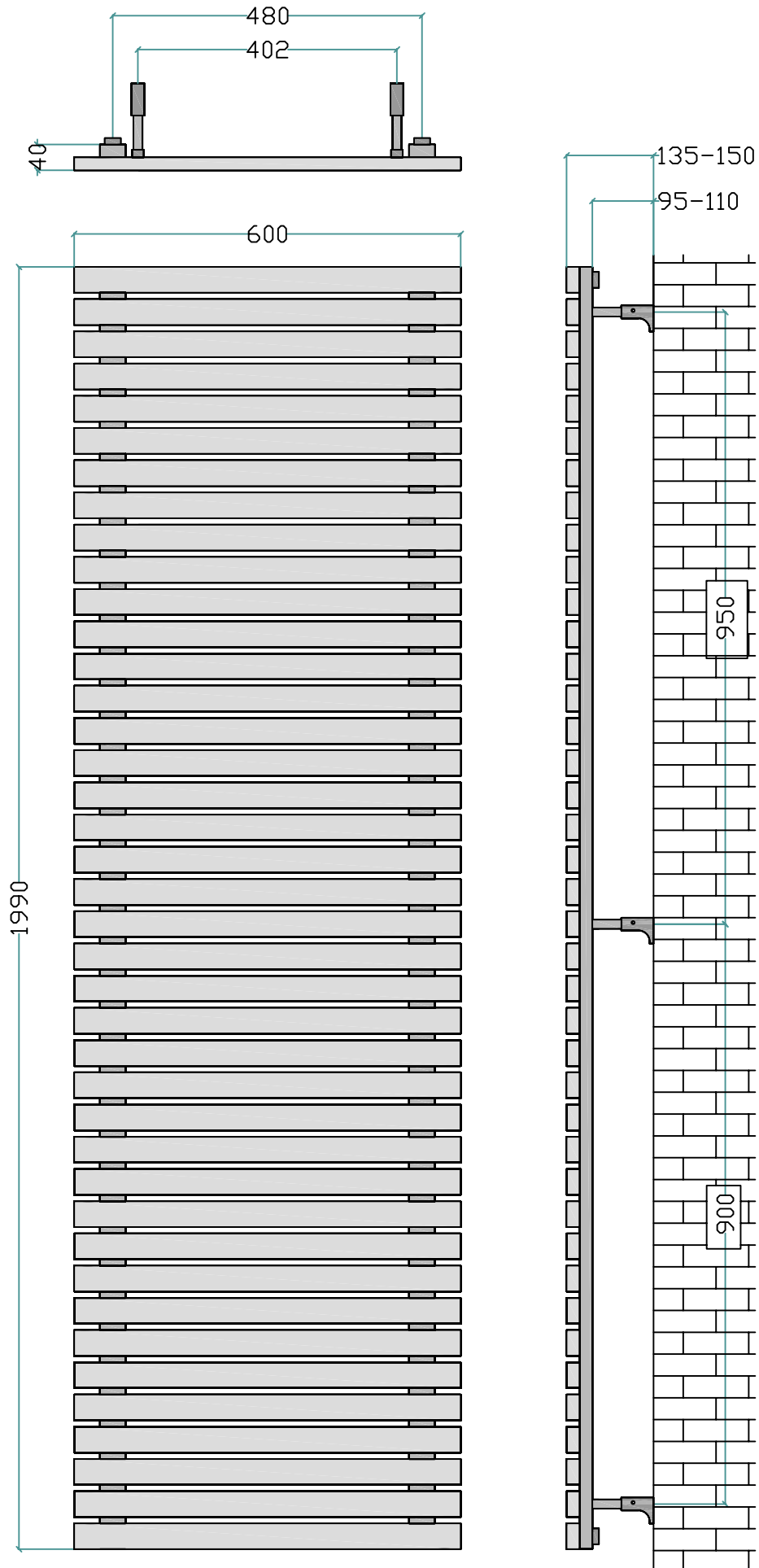

Watt	1.975
BTU	6.740
kcal / h	1.698

Dune 60 / 40