

Watt	144
BTU	491
kcal / h	124

Daisy 4

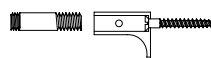
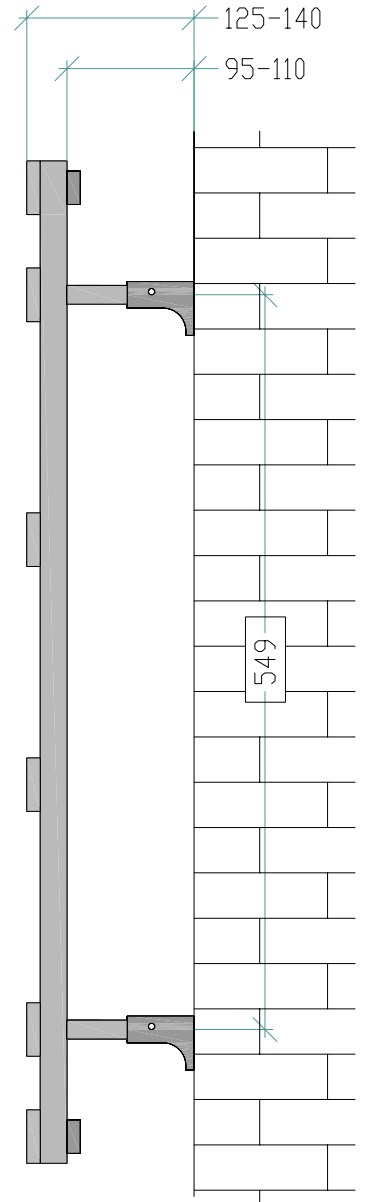
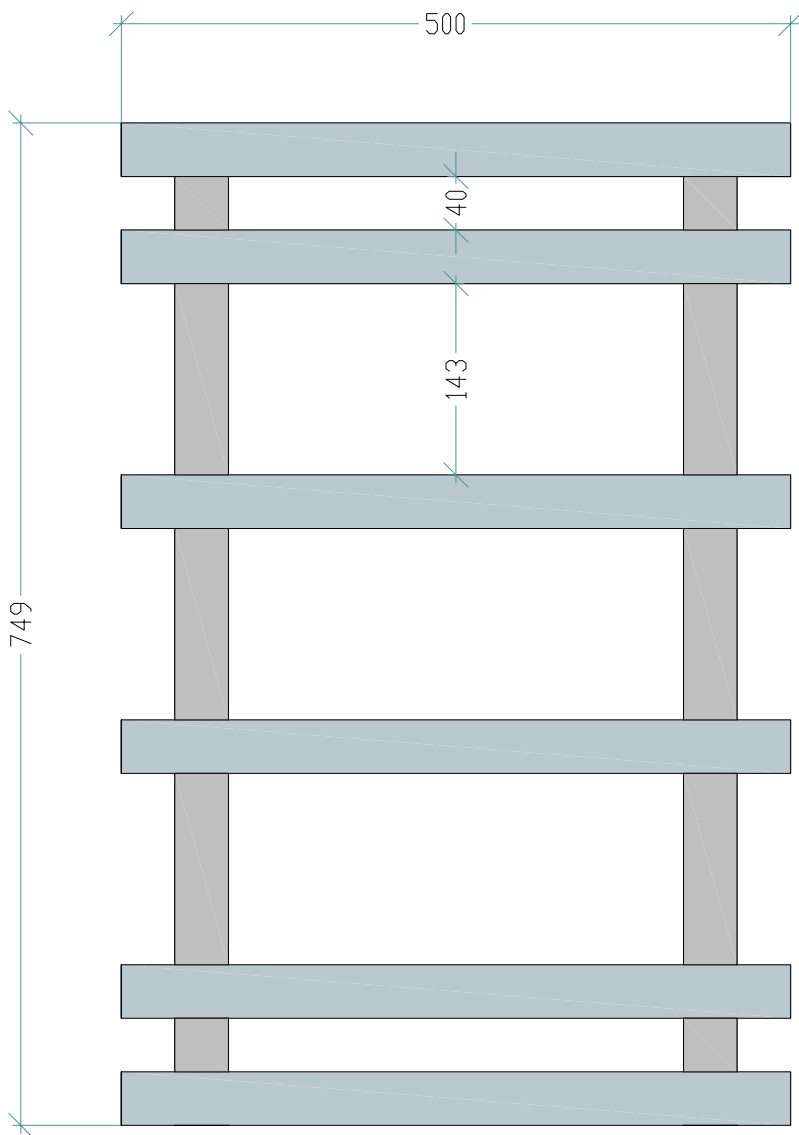
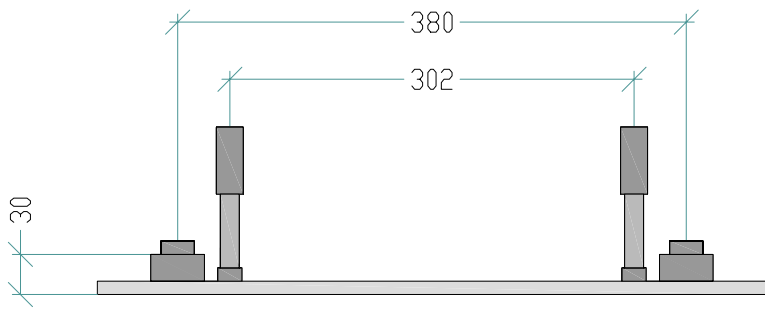

Watt	216
BTU	737
kcal / h	186

Daisy 6

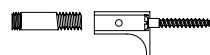
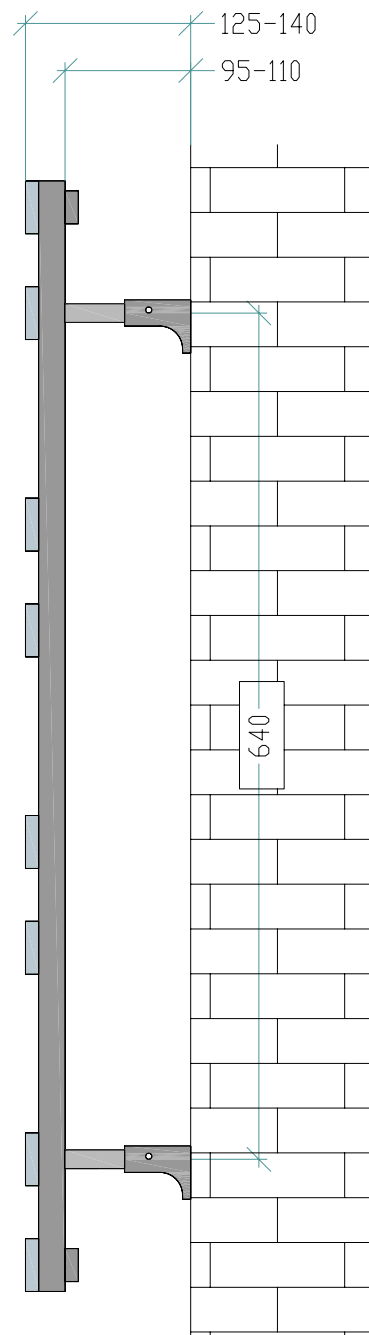
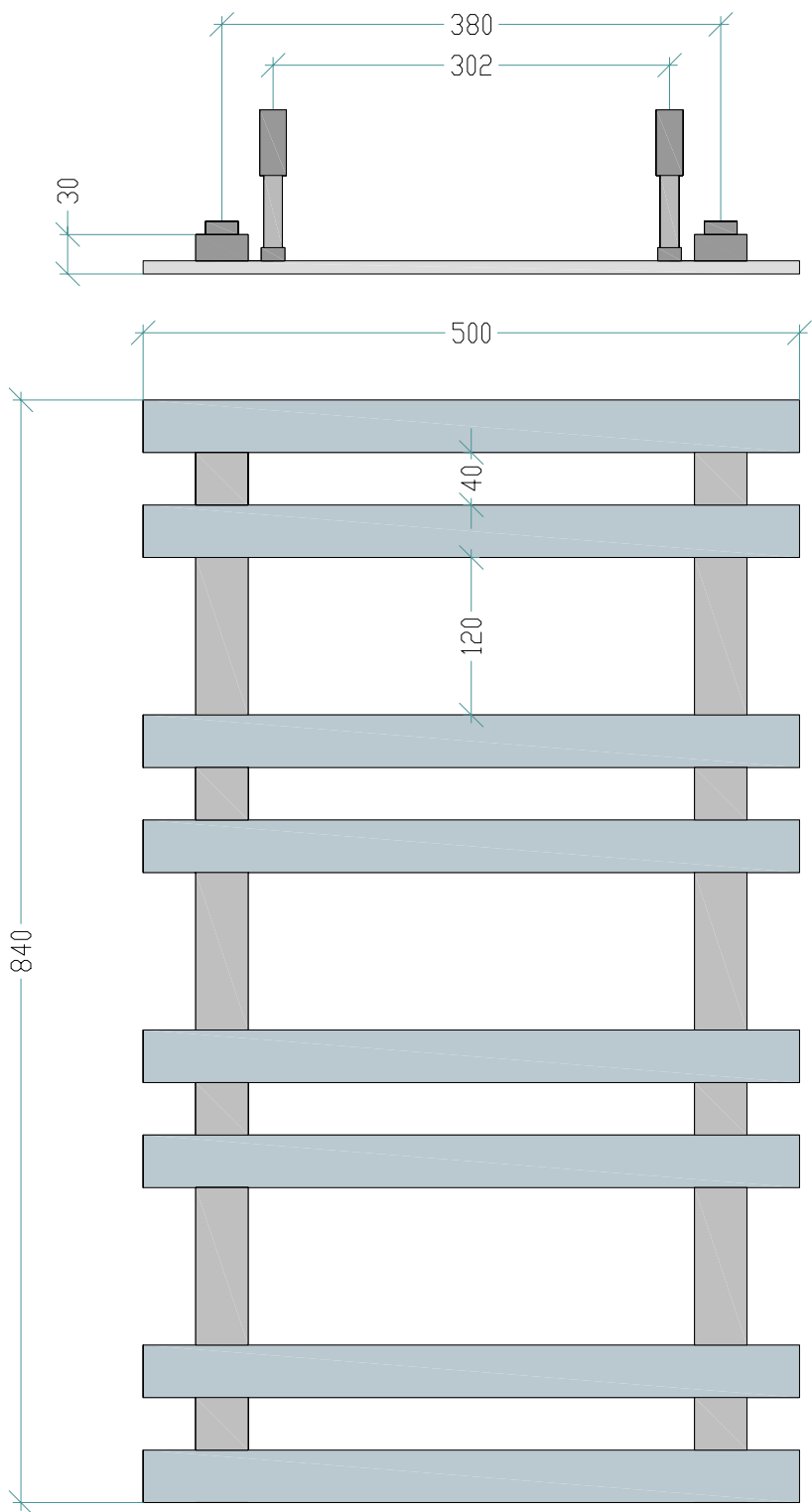

Watt	288
BTU	983
kcal / h	248

Daisy 8

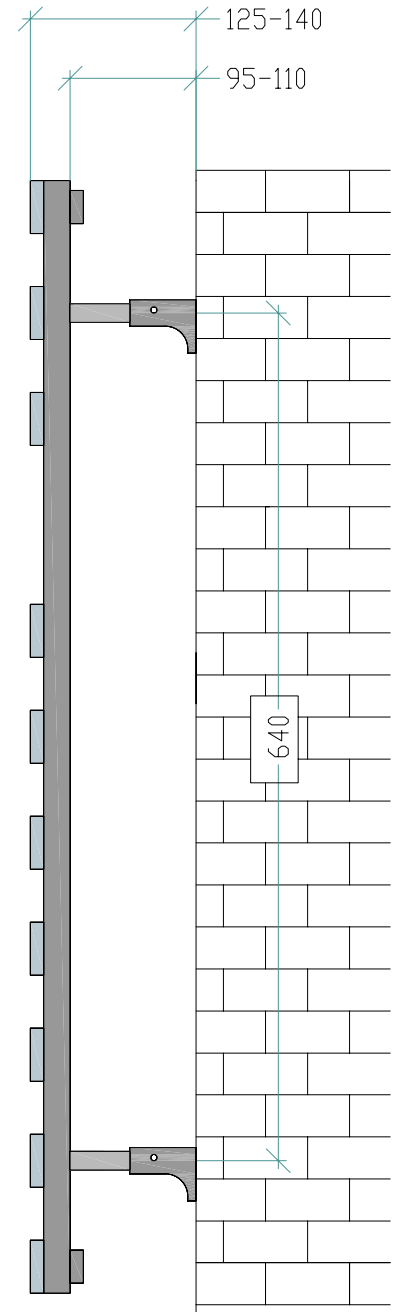
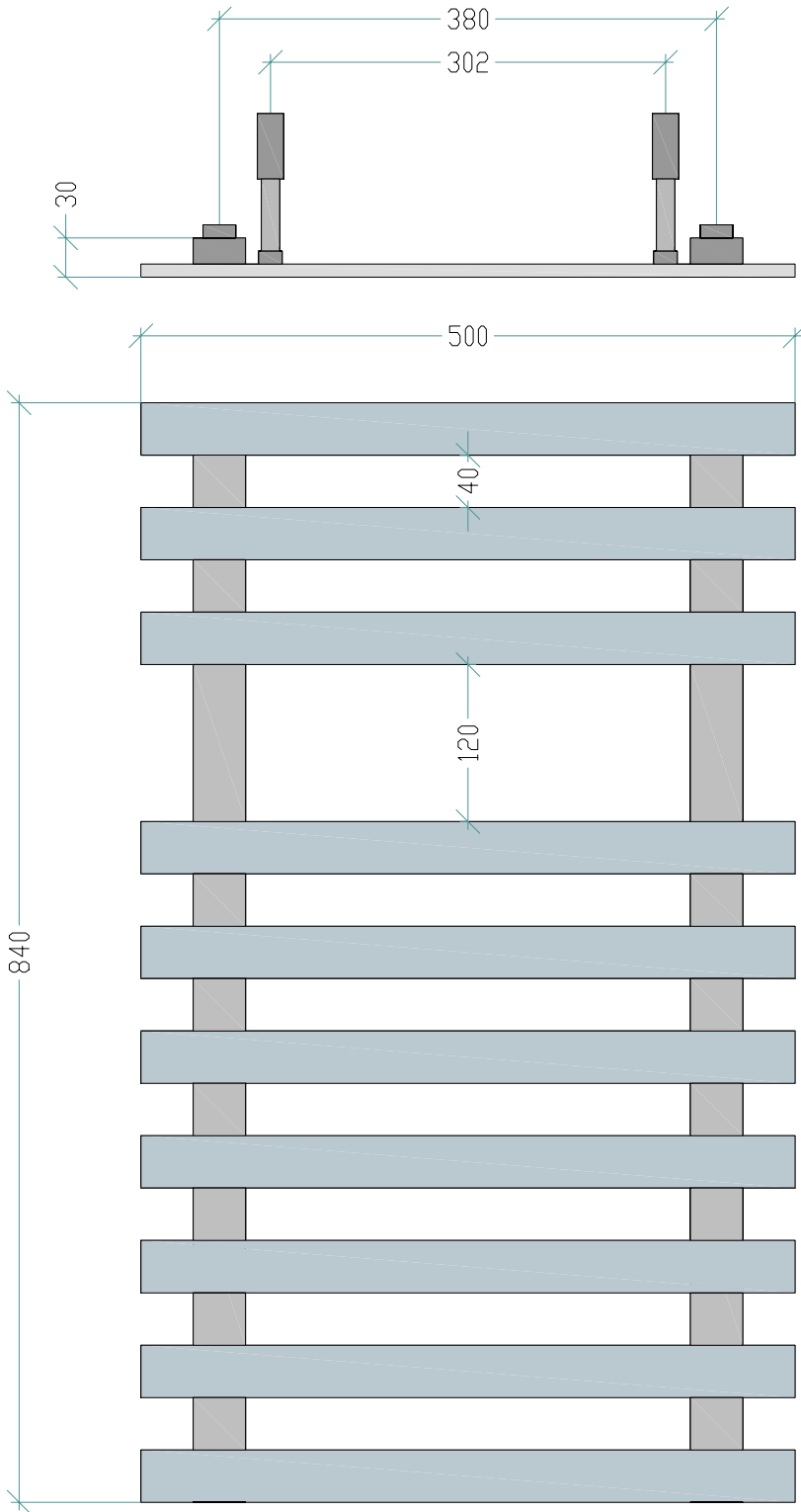

Watt	360
BTU	1.228
kcal / h	310

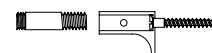

**Daisy 10**

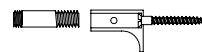
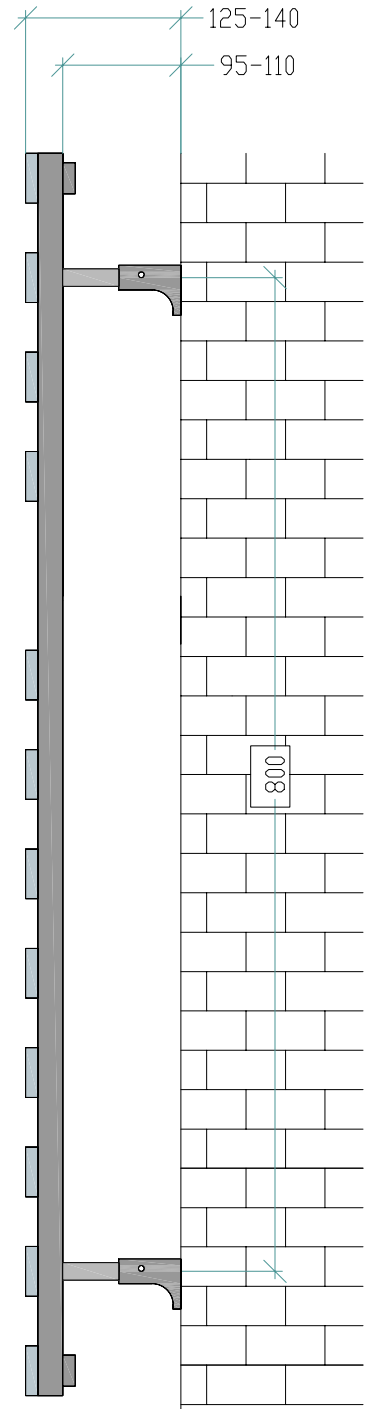
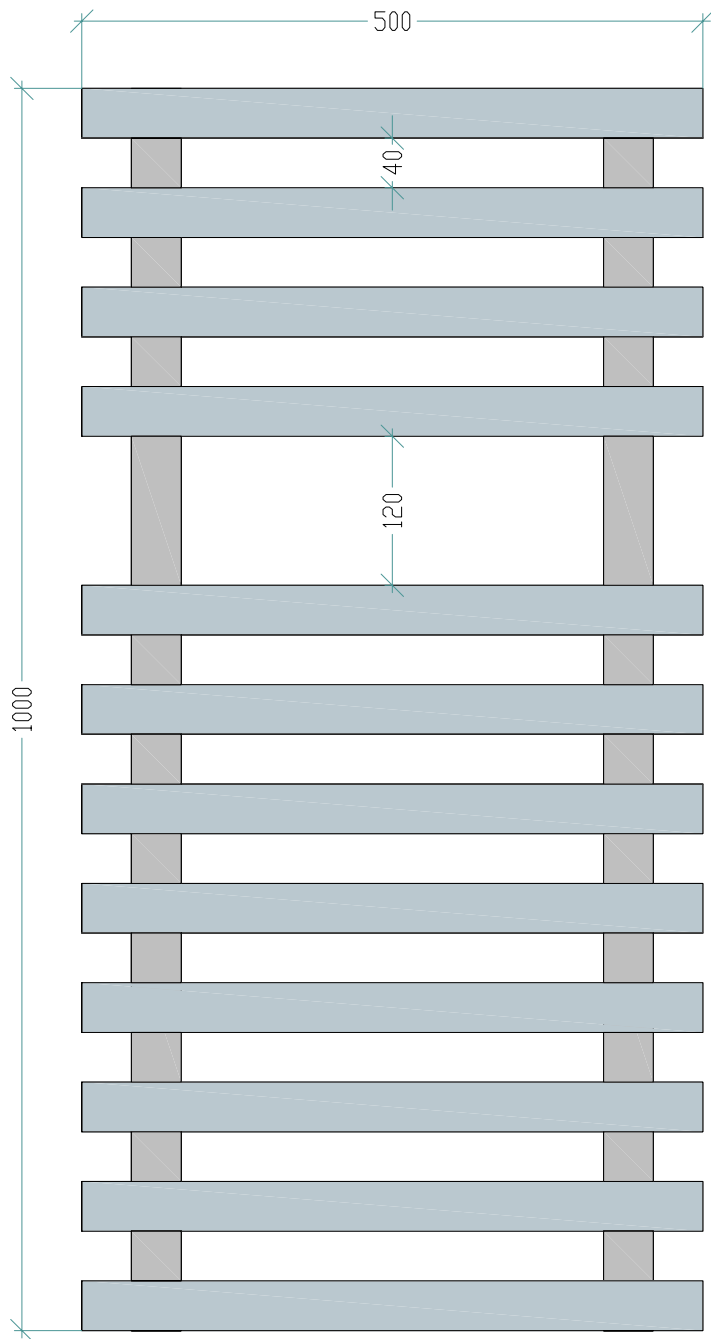
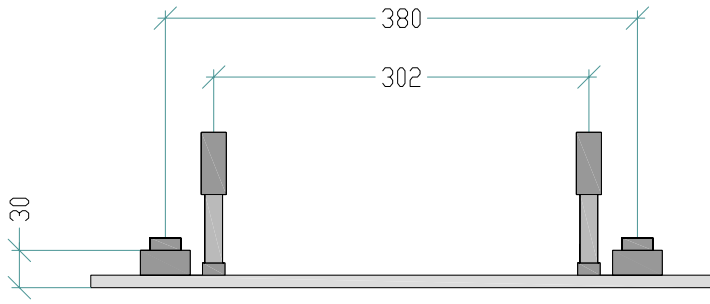

Watt	432
BTU	1.474
kcal / h	371

Daisy 12

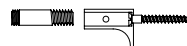
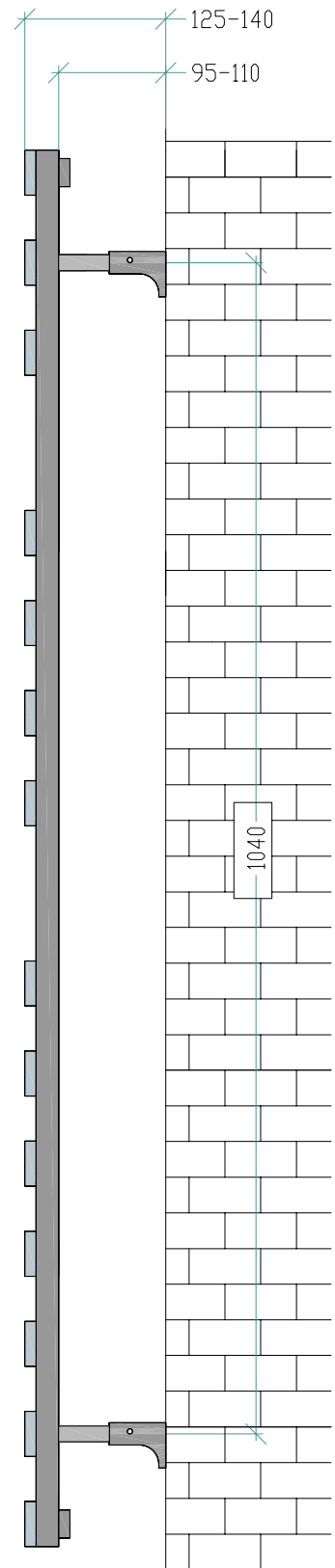
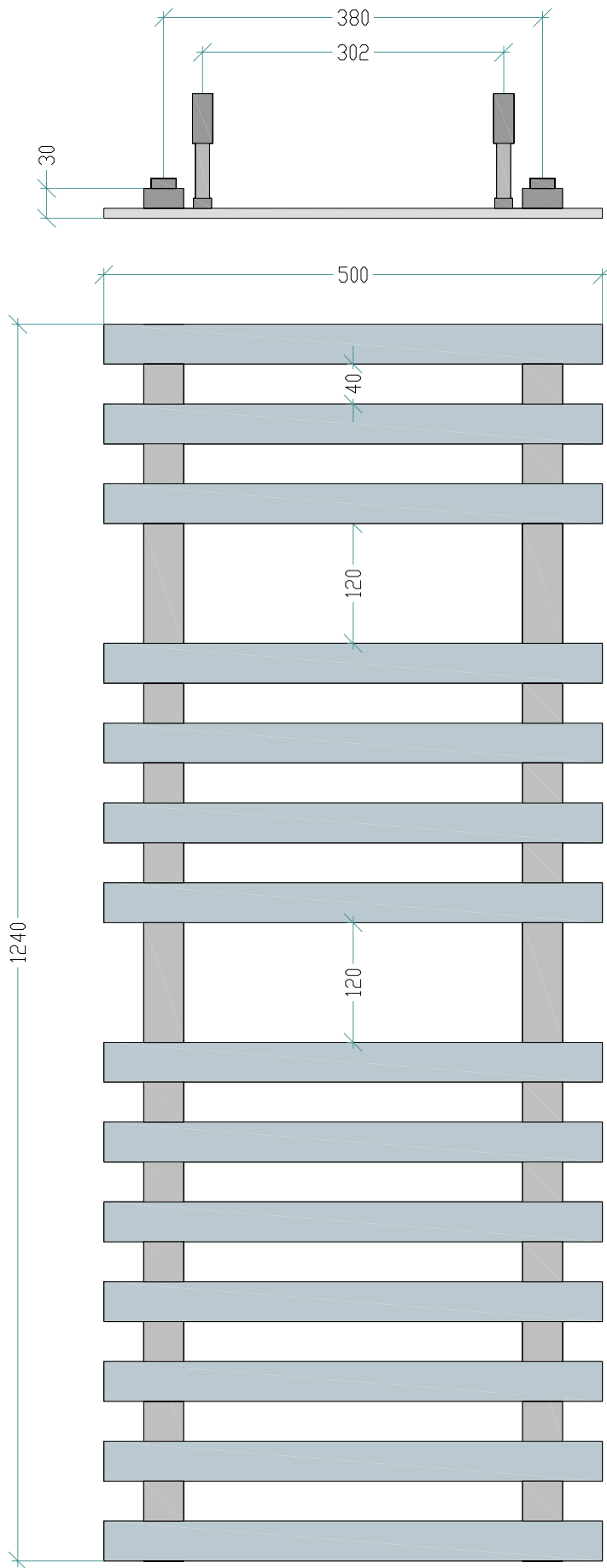

Watt	504
BTU	1.720
kcal / h	433

**Daisy 14**