

CANNON 50XL03

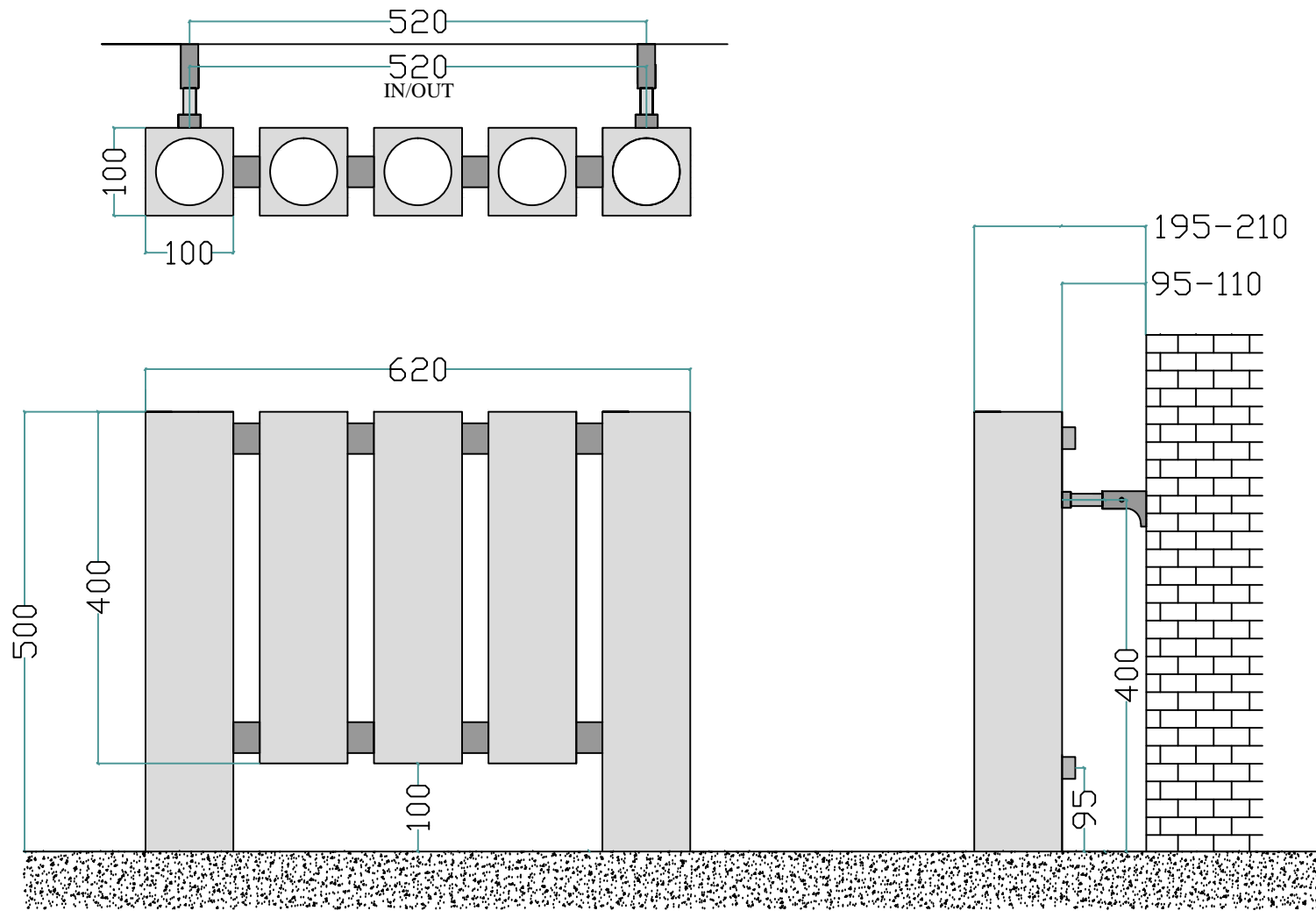

KORLE	Watt	BTU	Watt	BTU
	$\Delta 50^{\circ}\text{C}$	$\Delta 50^{\circ}\text{C}$	$\Delta 60^{\circ}\text{C}$	$\Delta 60^{\circ}\text{C}$
Cannon 50XL05	510	1739	644	2199

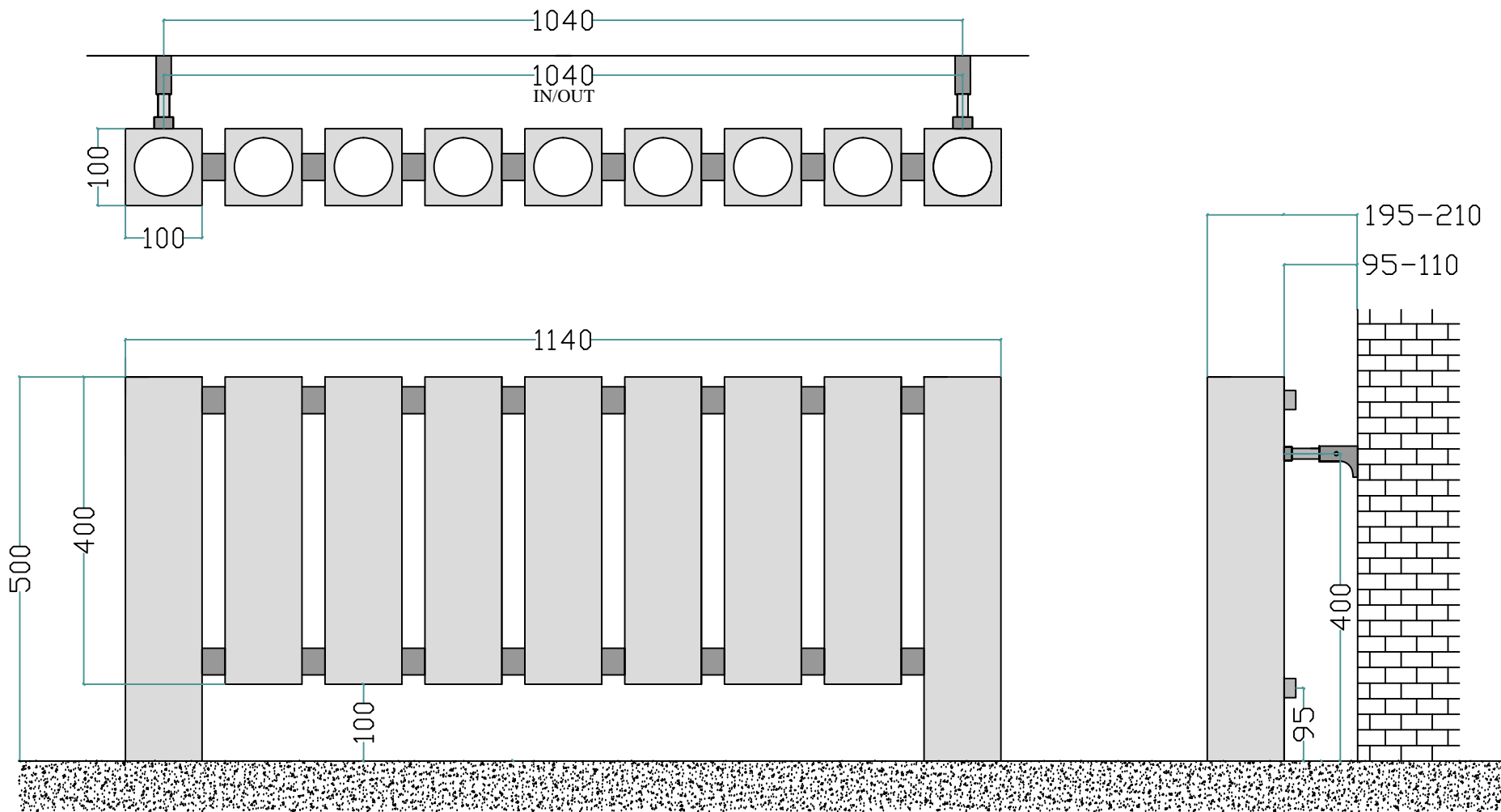

KORLE Cannon 50XL09	Watt	BTU	Watt	BTU
	$\Delta 50^{\circ}\text{C}$	$\Delta 50^{\circ}\text{C}$	$\Delta 60^{\circ}\text{C}$	$\Delta 60^{\circ}\text{C}$
	880	3004	1113	3798

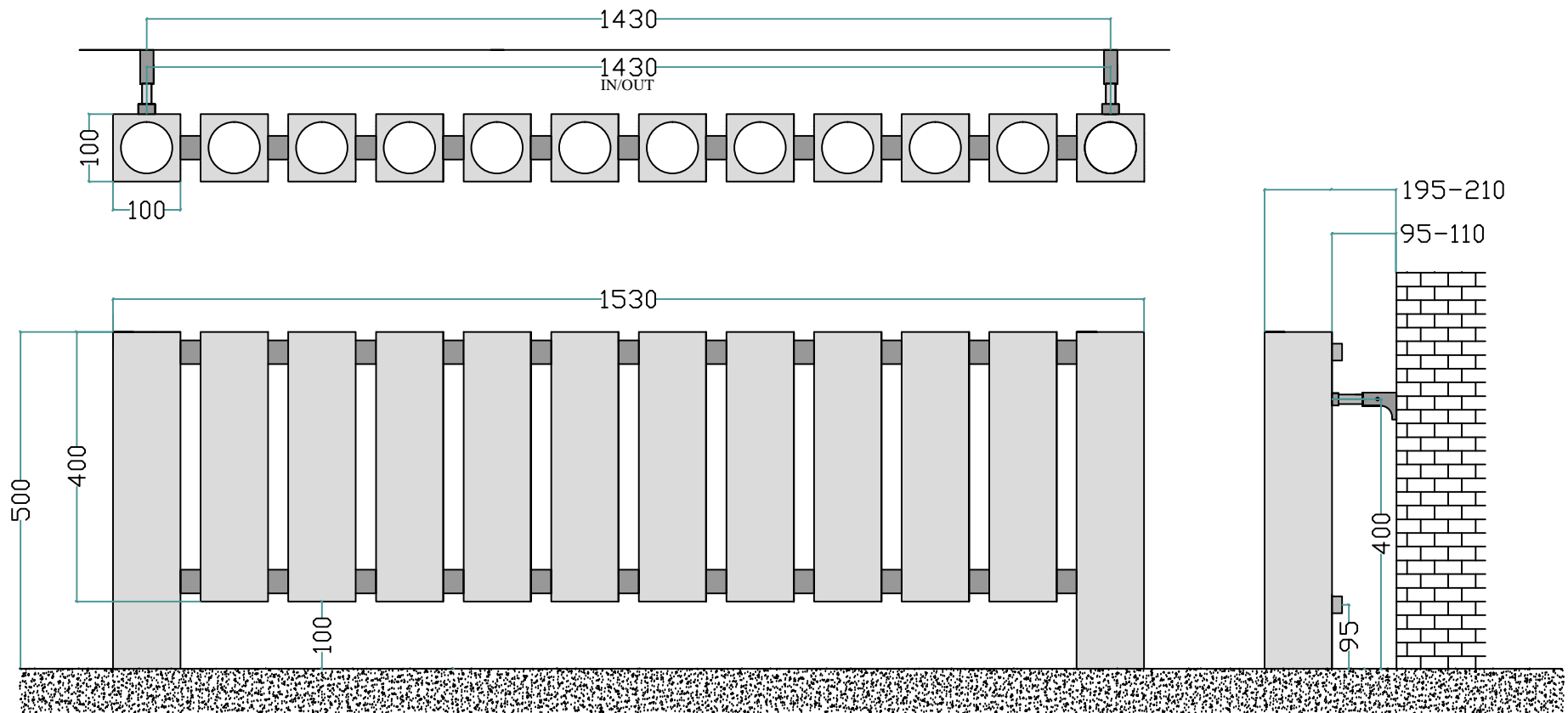

KORLE	Watt	BTU	Watt	BTU
	$\Delta 50^{\circ}\text{C}$	$\Delta 50^{\circ}\text{C}$	$\Delta 60^{\circ}\text{C}$	$\Delta 60^{\circ}\text{C}$
Cannon 50XL12	1158	3953	1464	4998

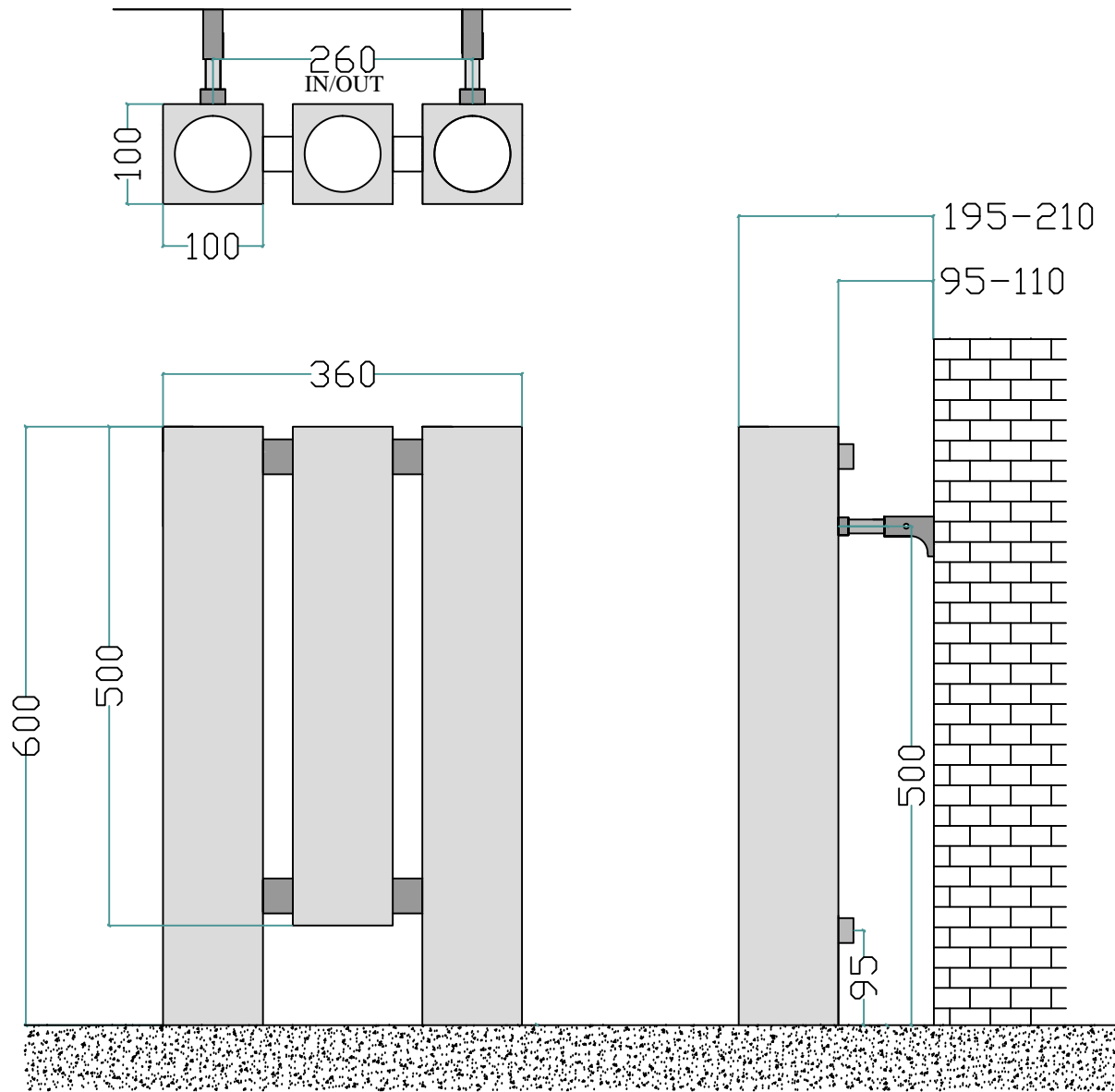

CANNON 60XL03

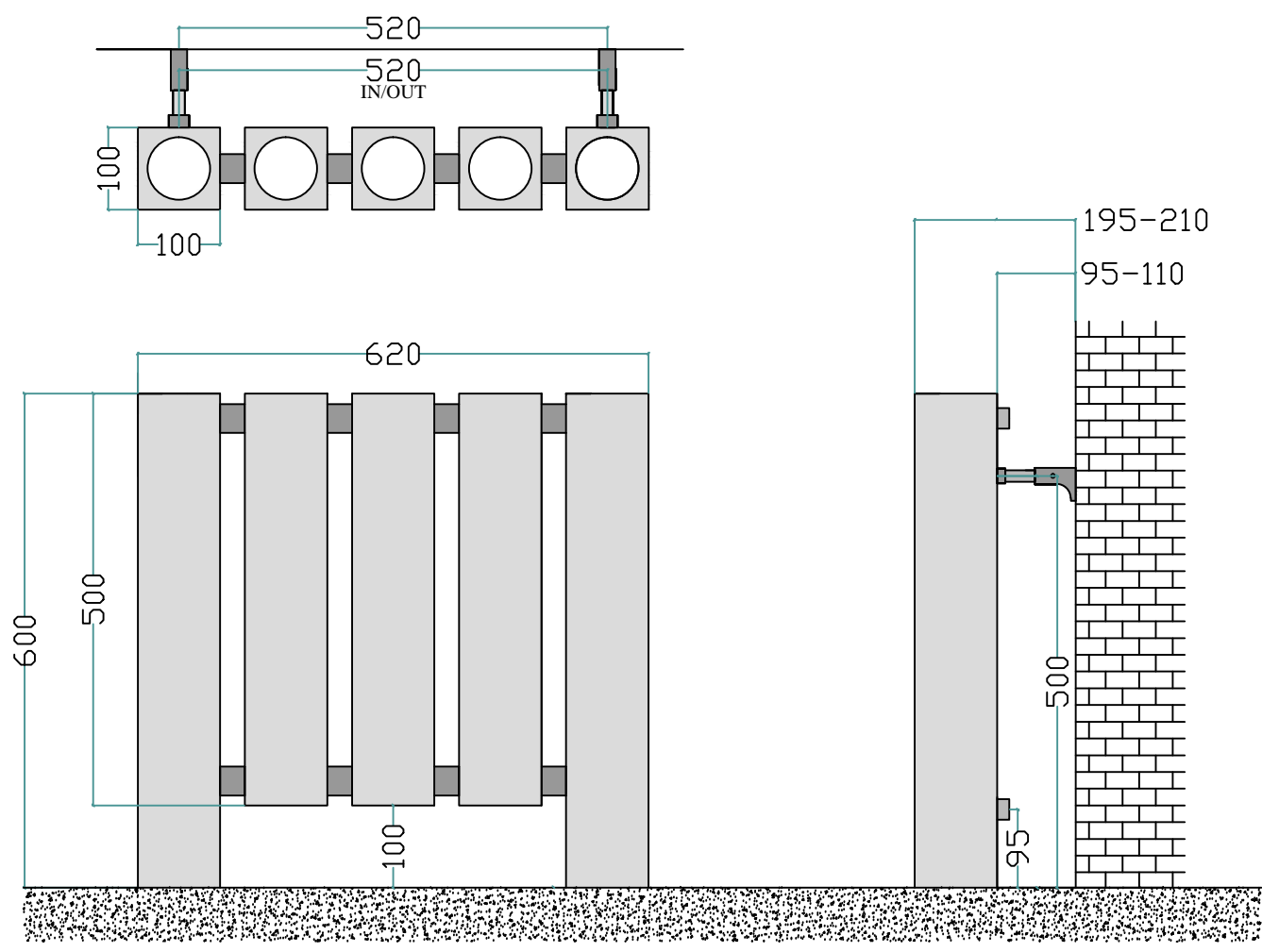

KORLE	Watt	BTU	Watt	BTU
	$\Delta 50^{\circ}\text{C}$	$\Delta 50^{\circ}\text{C}$	$\Delta 60^{\circ}\text{C}$	$\Delta 60^{\circ}\text{C}$
Cannon 60XL05	625	2134	791	2699

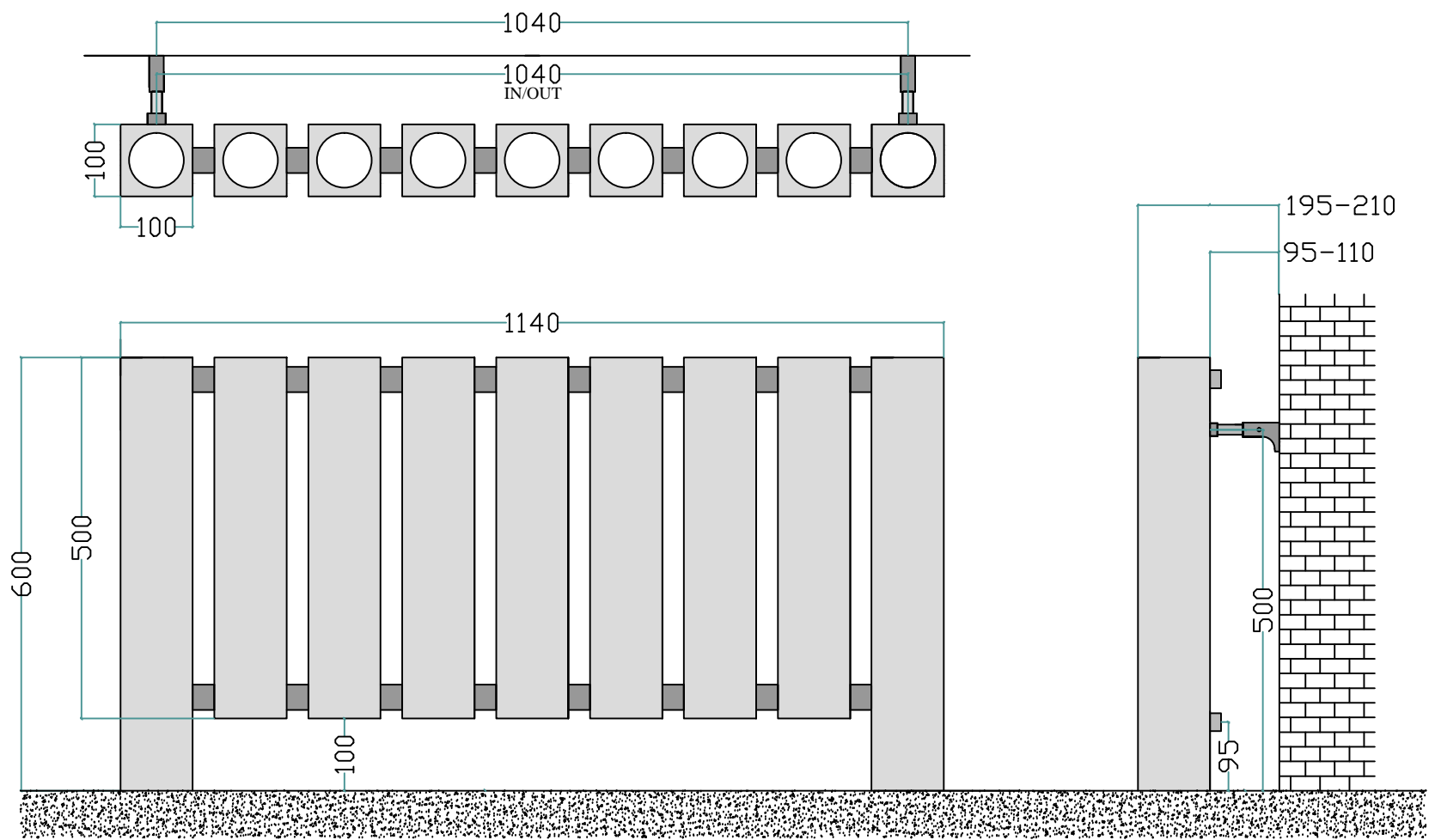

KORLE Canon 60XL09	Watt	BTU	Watt	BTU
	$\Delta 50^{\circ}\text{C}$	$\Delta 50^{\circ}\text{C}$	$\Delta 60^{\circ}\text{C}$	$\Delta 60^{\circ}\text{C}$
	1089	3715	1376	4698

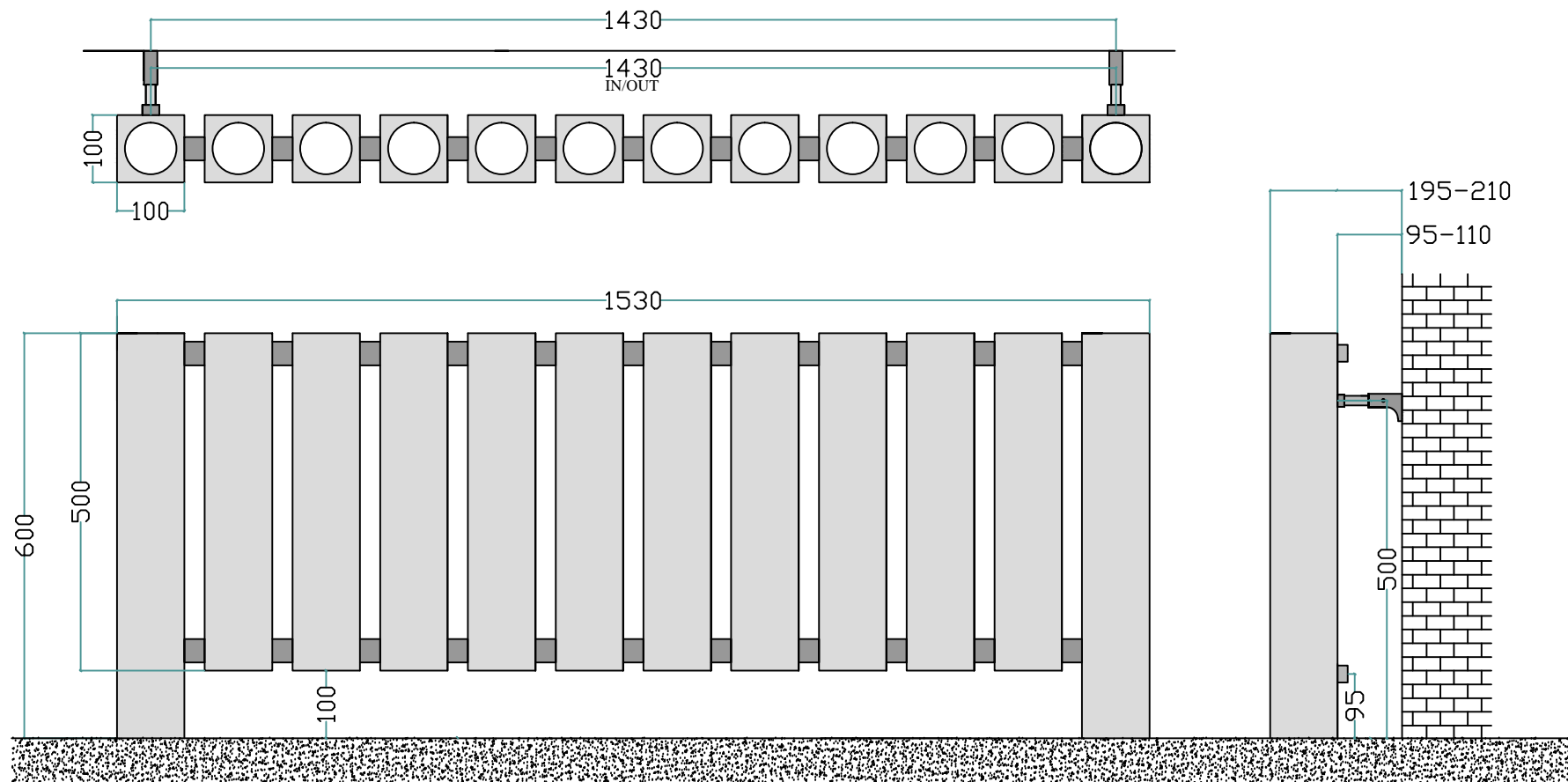

KORLE	Watt	BTU	Watt	BTU
	$\Delta 50^\circ\text{C}$	$\Delta 50^\circ\text{C}$	$\Delta 60^\circ\text{C}$	$\Delta 60^\circ\text{C}$
Cannon 60XL12	1436	4901	1816	6197

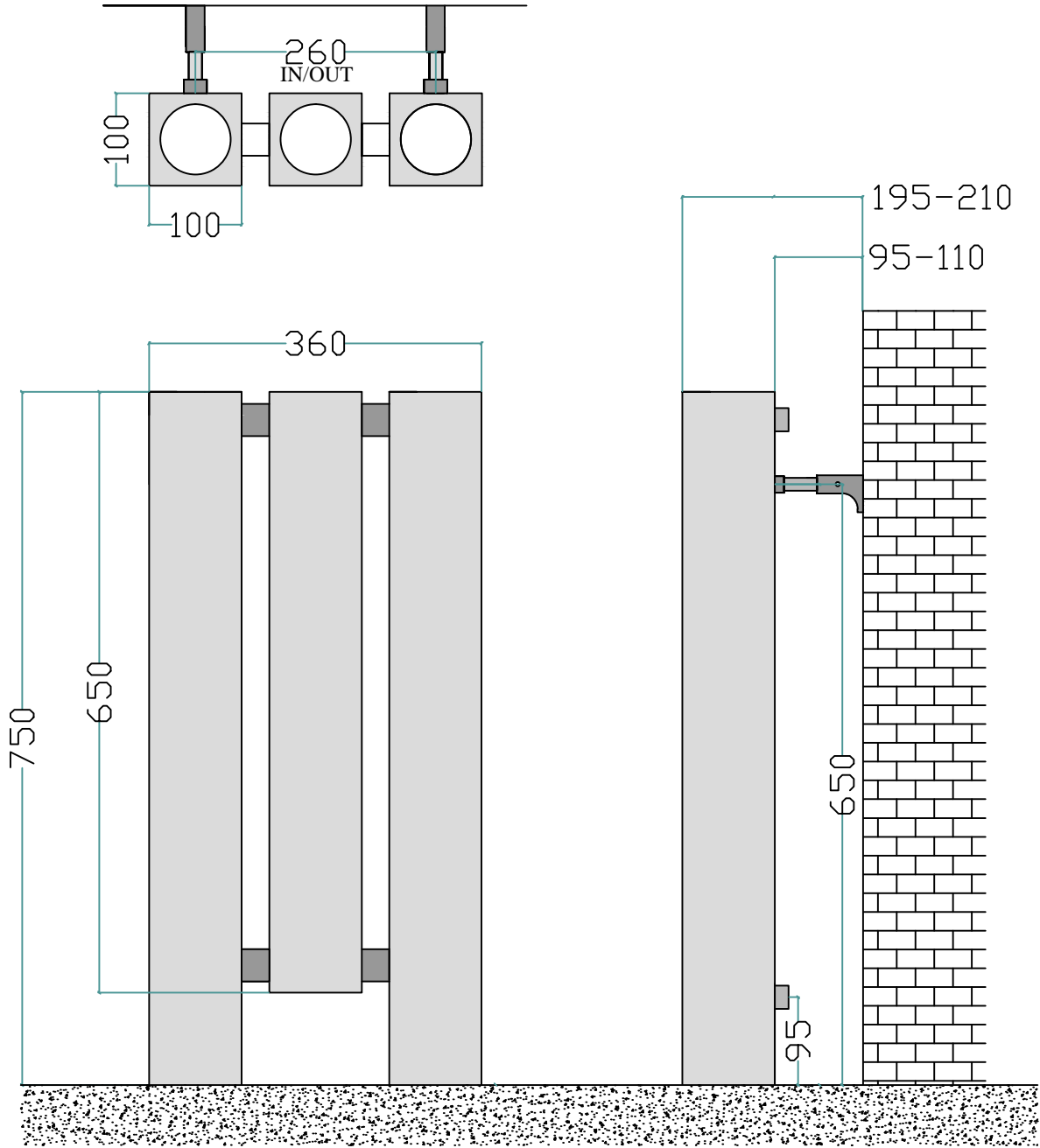

CANNON 75XL03

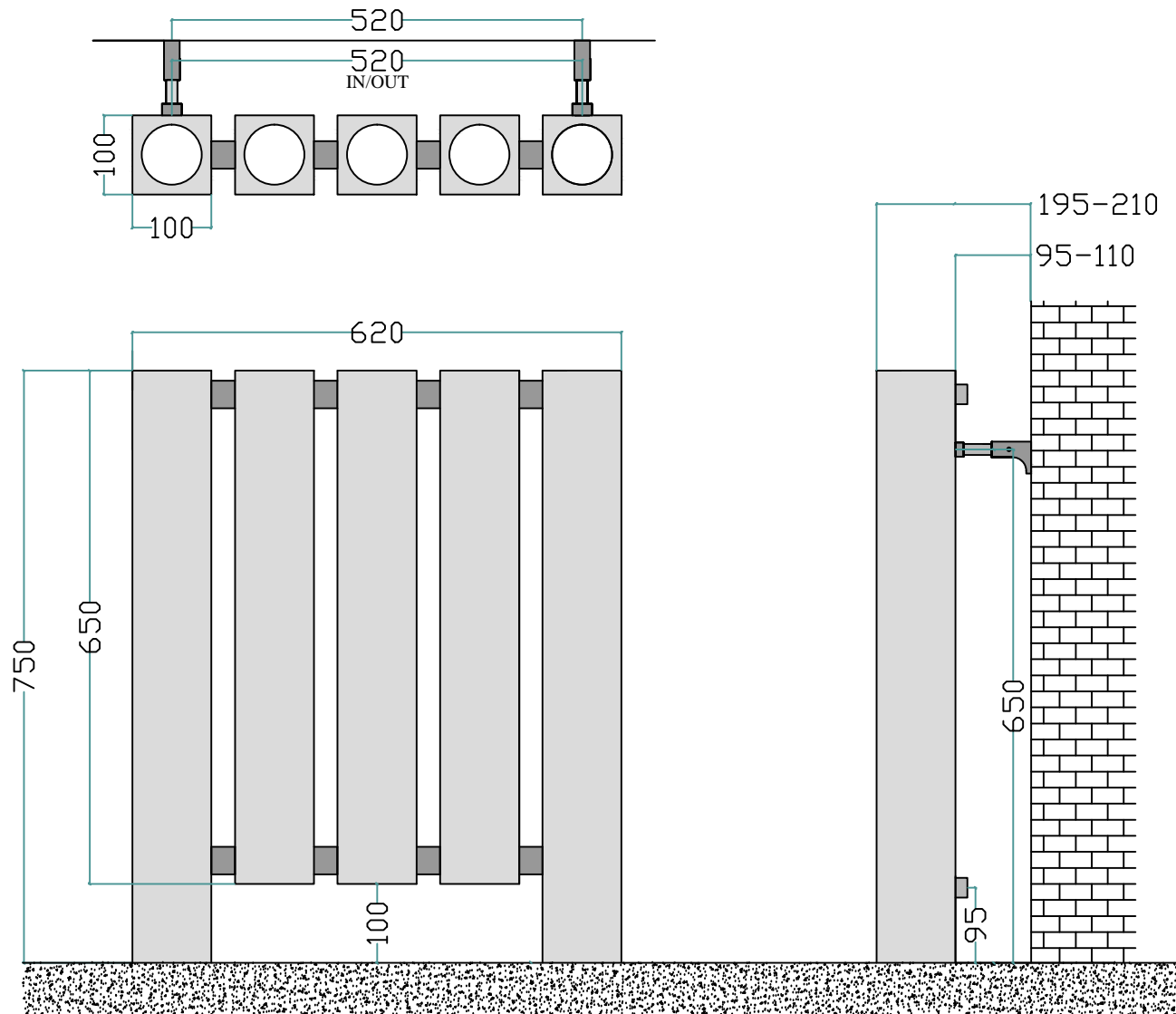

KORLE	Watt	BTU	Watt	BTU
	$\Delta 50^\circ\text{C}$	$\Delta 50^\circ\text{C}$	$\Delta 60^\circ\text{C}$	$\Delta 60^\circ\text{C}$
Cannon 75XL05	799	2727	1010	3449

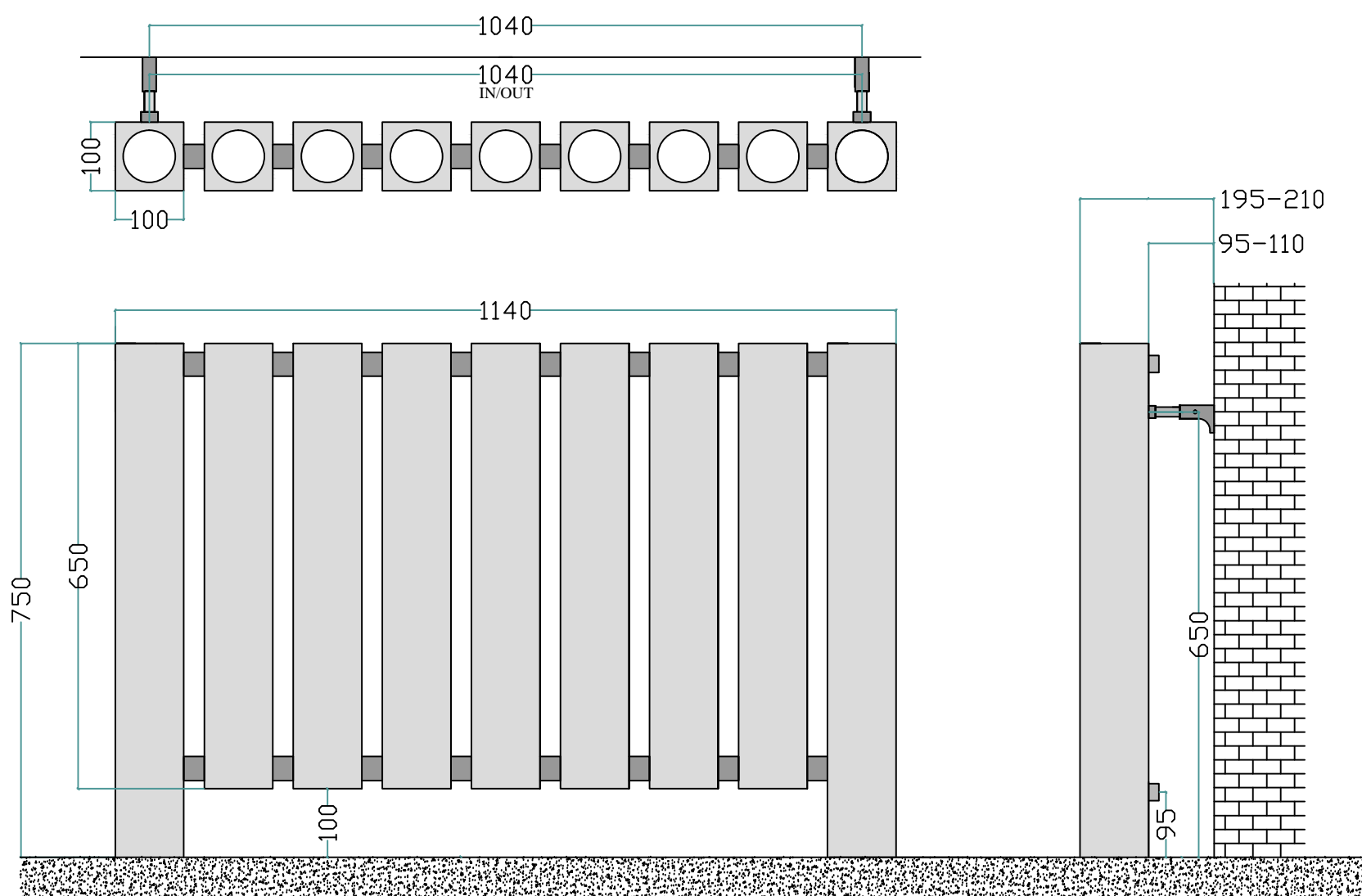

KORLE	Watt	BTU	Watt	BTU
	$\Delta 50^{\circ}\text{C}$	$\Delta 50^{\circ}\text{C}$	$\Delta 60^{\circ}\text{C}$	$\Delta 60^{\circ}\text{C}$
Cannon 75XL09	1401	4783	1772	6048

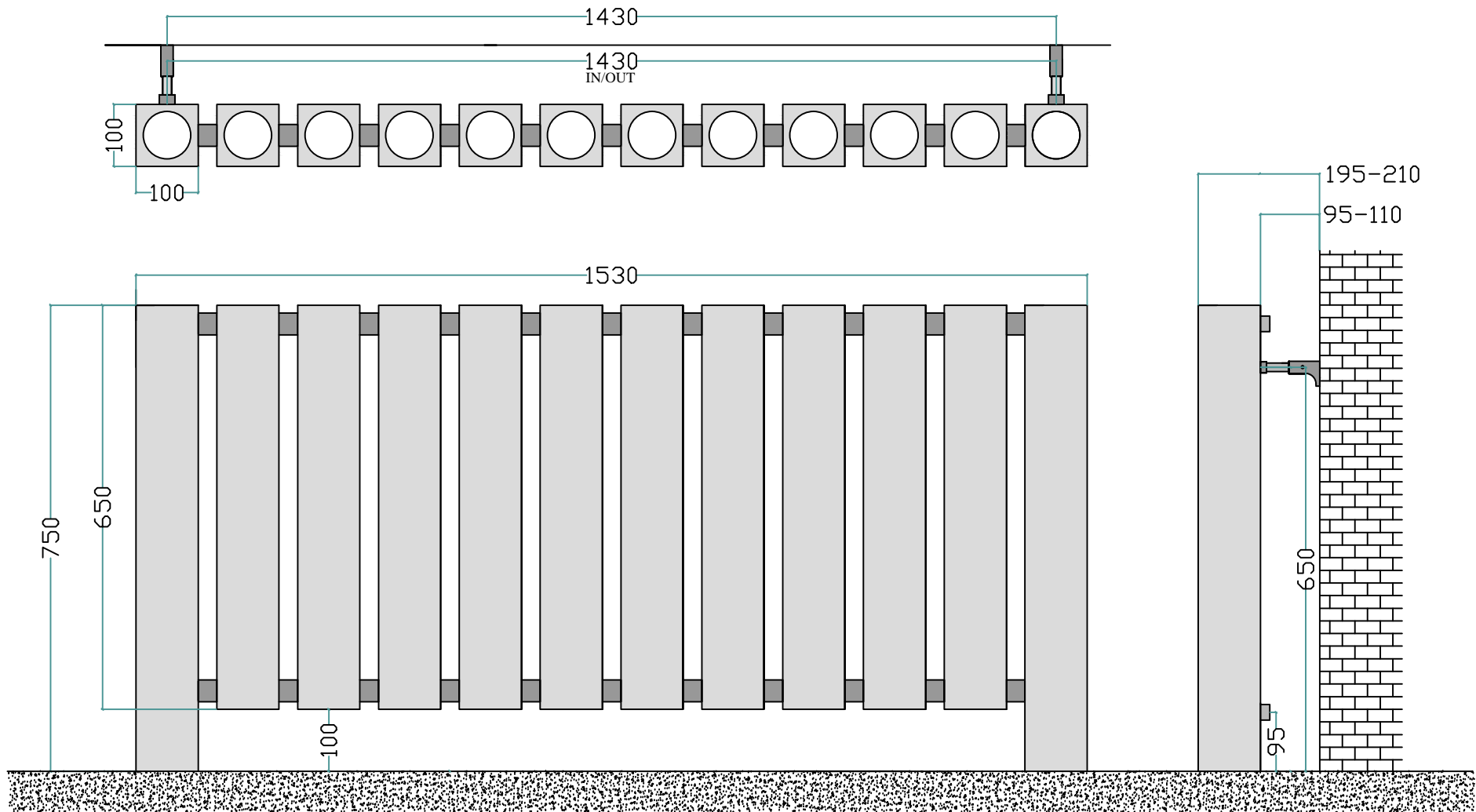

KORLE Cannon 75XL12	Watt	BTU	Watt	BTU
	$\Delta 50^{\circ}\text{C}$	$\Delta 50^{\circ}\text{C}$	$\Delta 60^{\circ}\text{C}$	$\Delta 60^{\circ}\text{C}$
	1853	6324	2343	7997

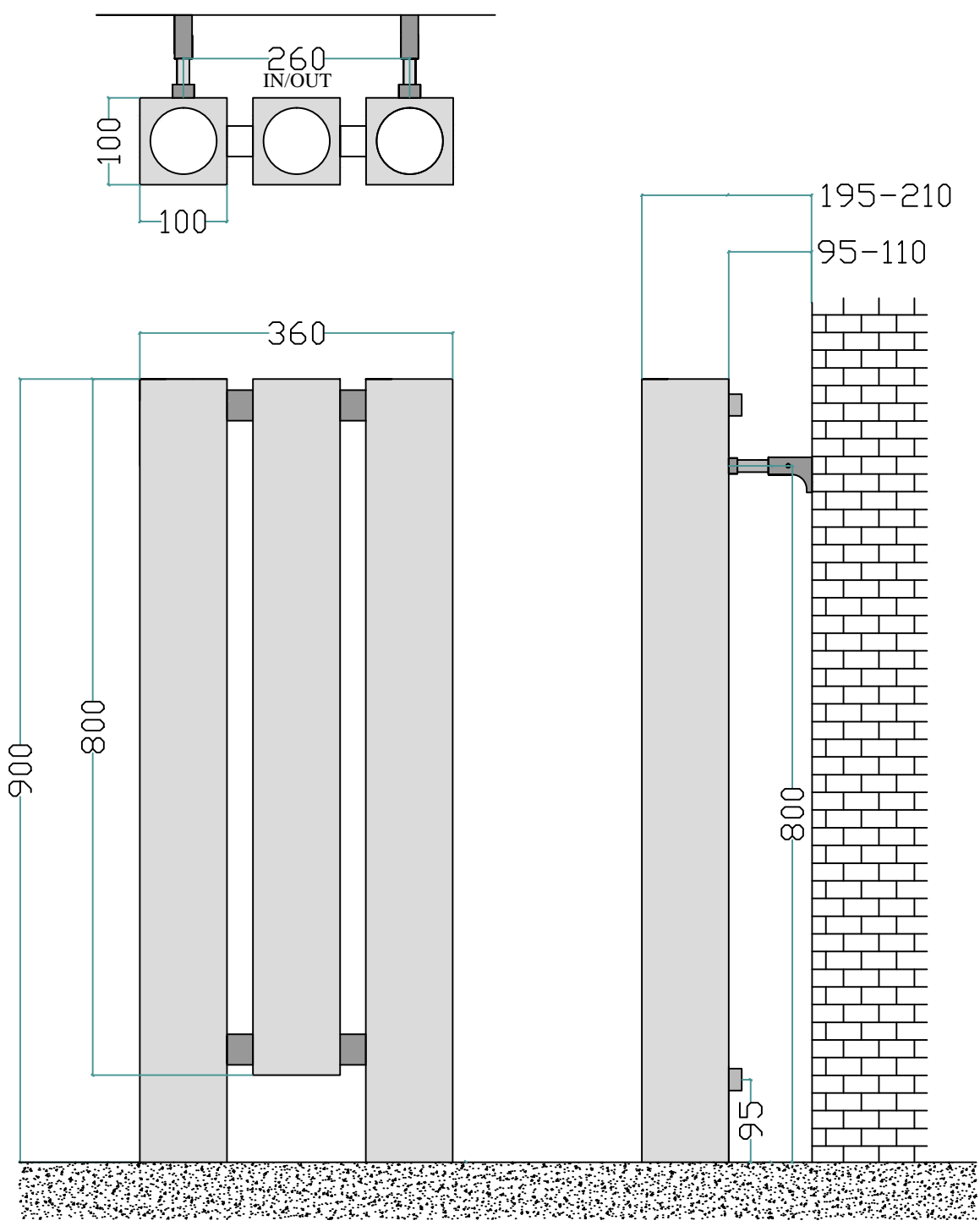

CANNON 90XL03

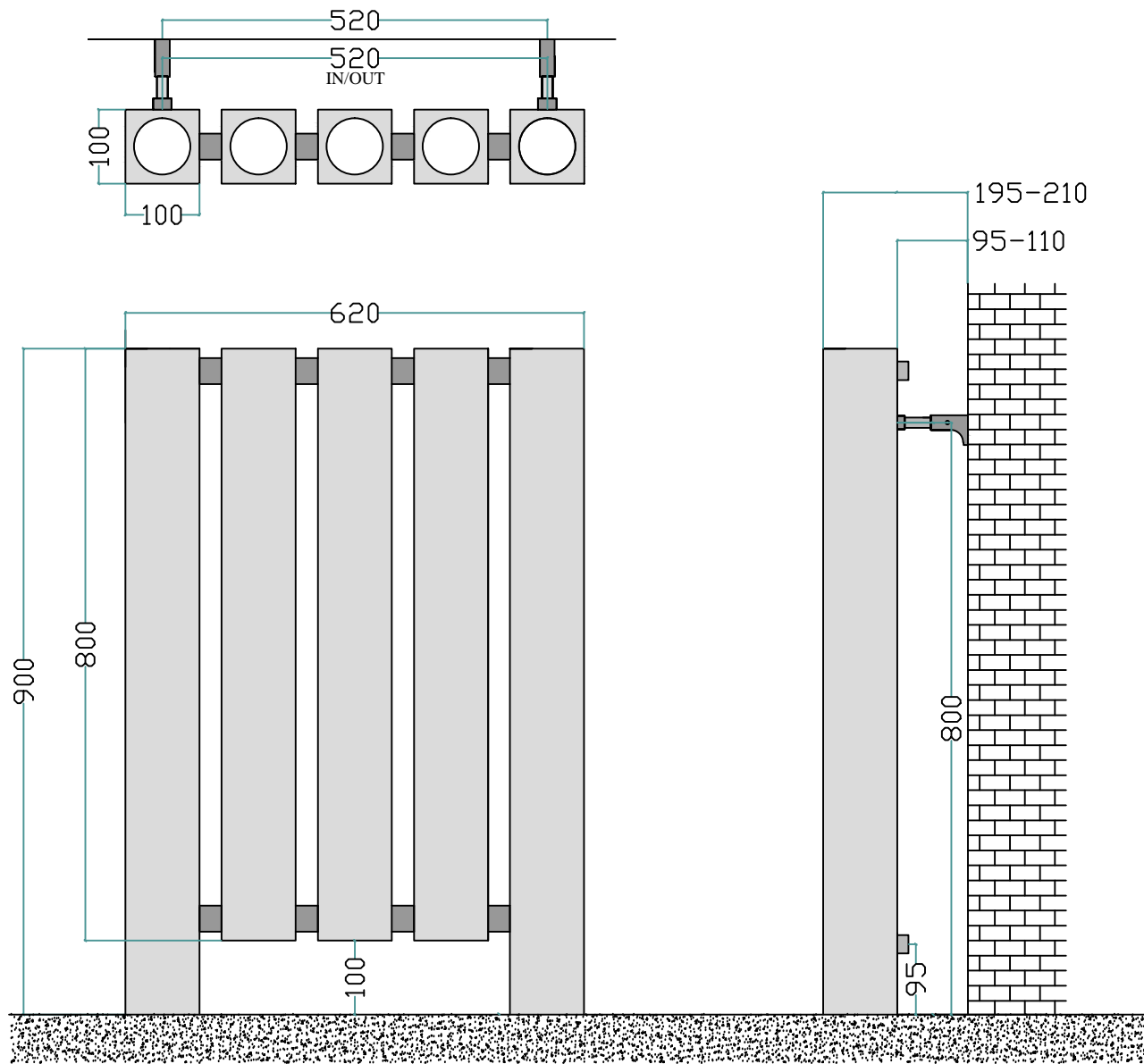

KORLE	Watt	BTU	Watt	BTU
	Δ 50°C	Δ 50°C	Δ 60°C	Δ 60°C
Cannon 90XL05	973	3320	1230	4198

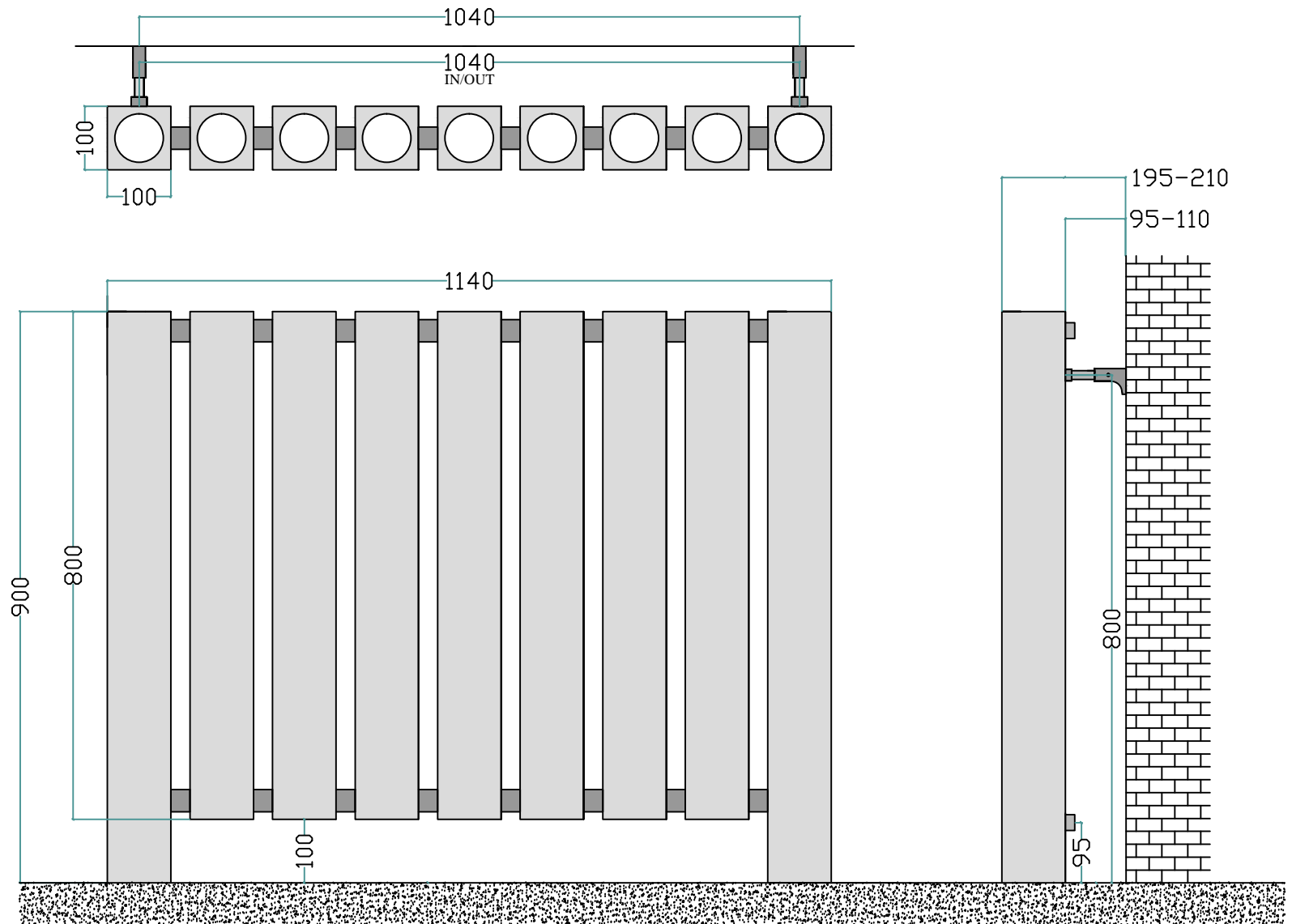

KORLE	Watt	BTU	Watt	BTU
	$\Delta 50^{\circ}\text{C}$	$\Delta 50^{\circ}\text{C}$	$\Delta 60^{\circ}\text{C}$	$\Delta 60^{\circ}\text{C}$
Cannon 90XL09	1714	5850	2167	7397

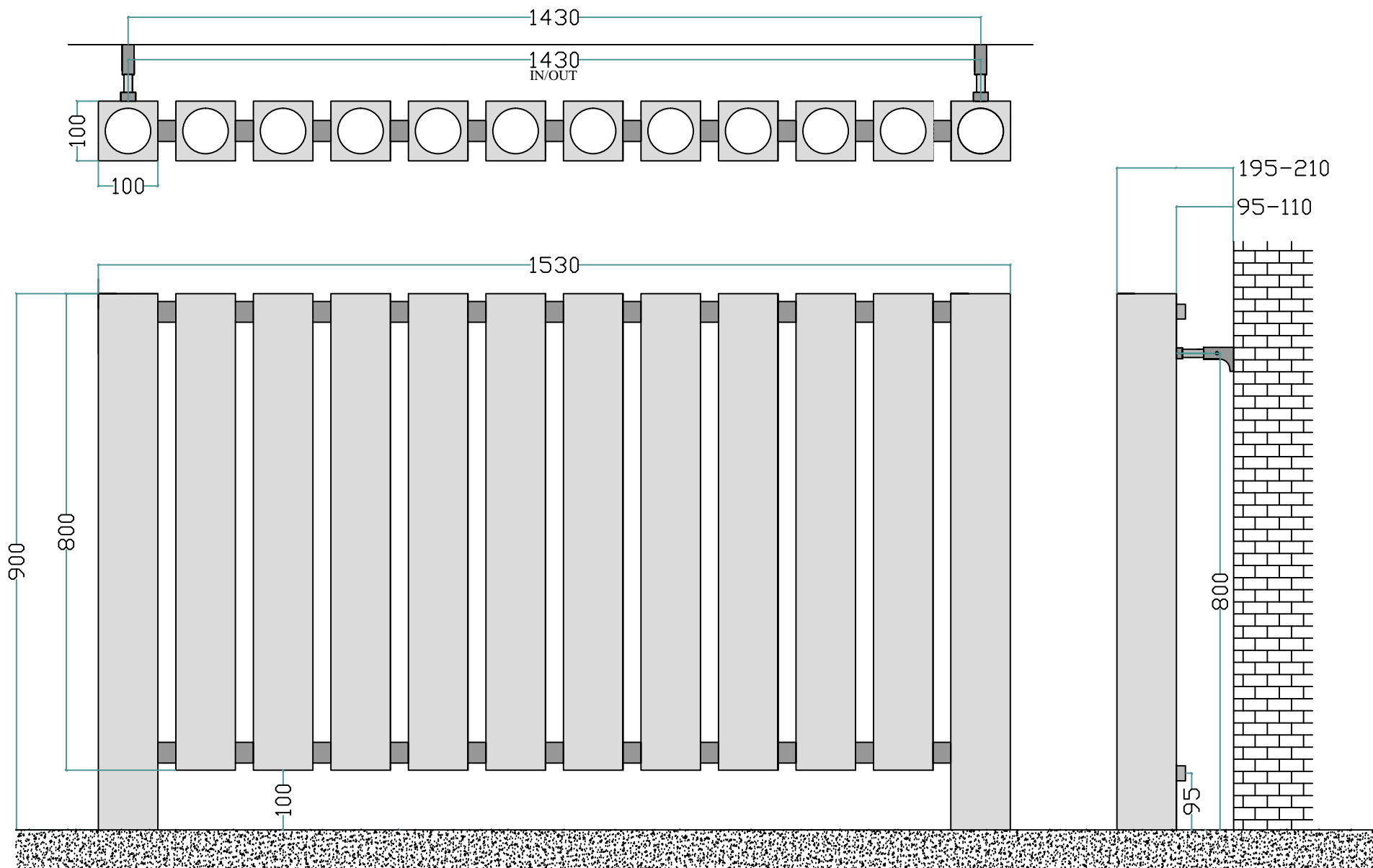

Cannon 90XL12

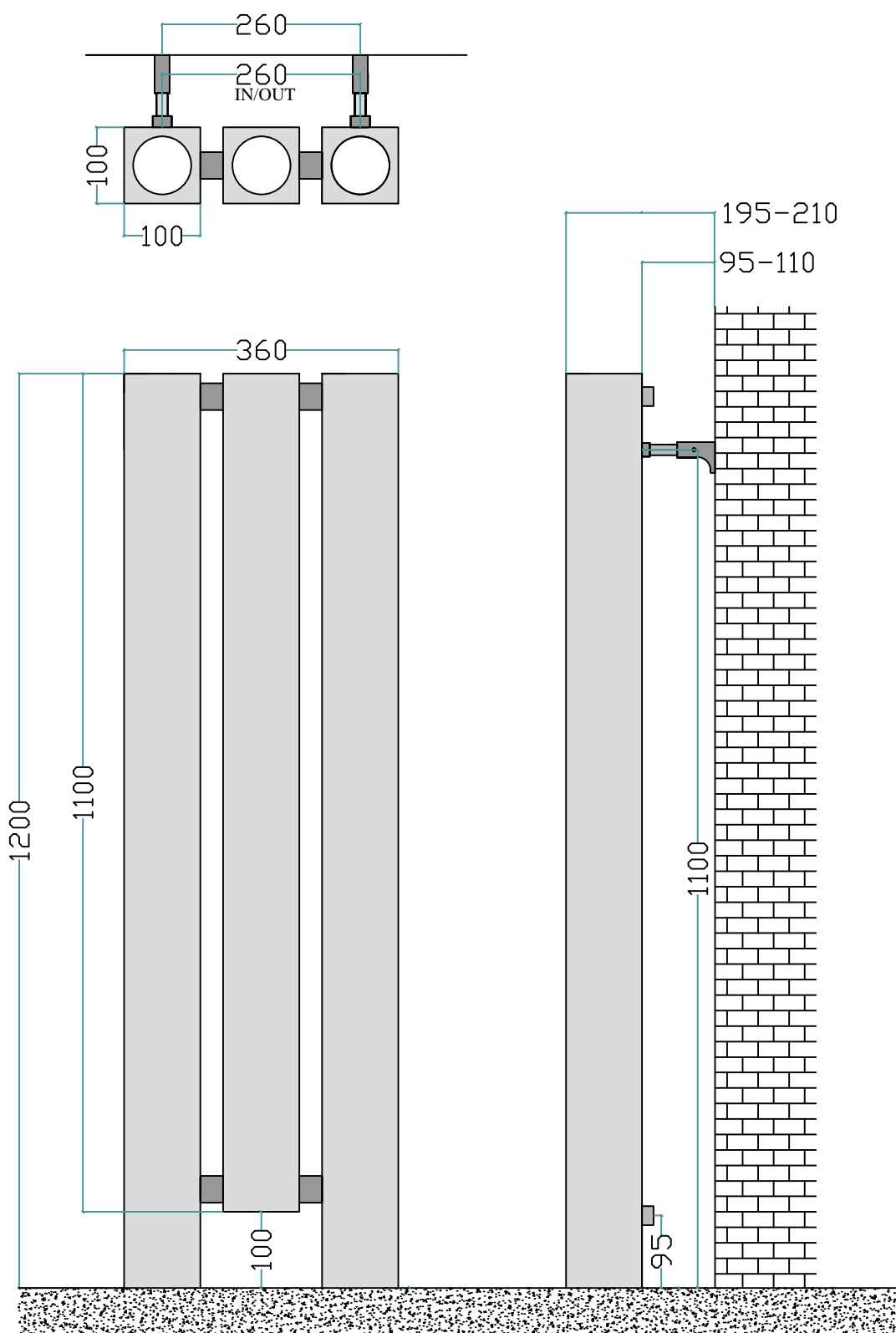

KORLE	Watt	BTU	Watt	BTU
	$\Delta 50^{\circ}\text{C}$	$\Delta 50^{\circ}\text{C}$	$\Delta 60^{\circ}\text{C}$	$\Delta 60^{\circ}\text{C}$
Cannon 120XL03	811	2767	1025	3499

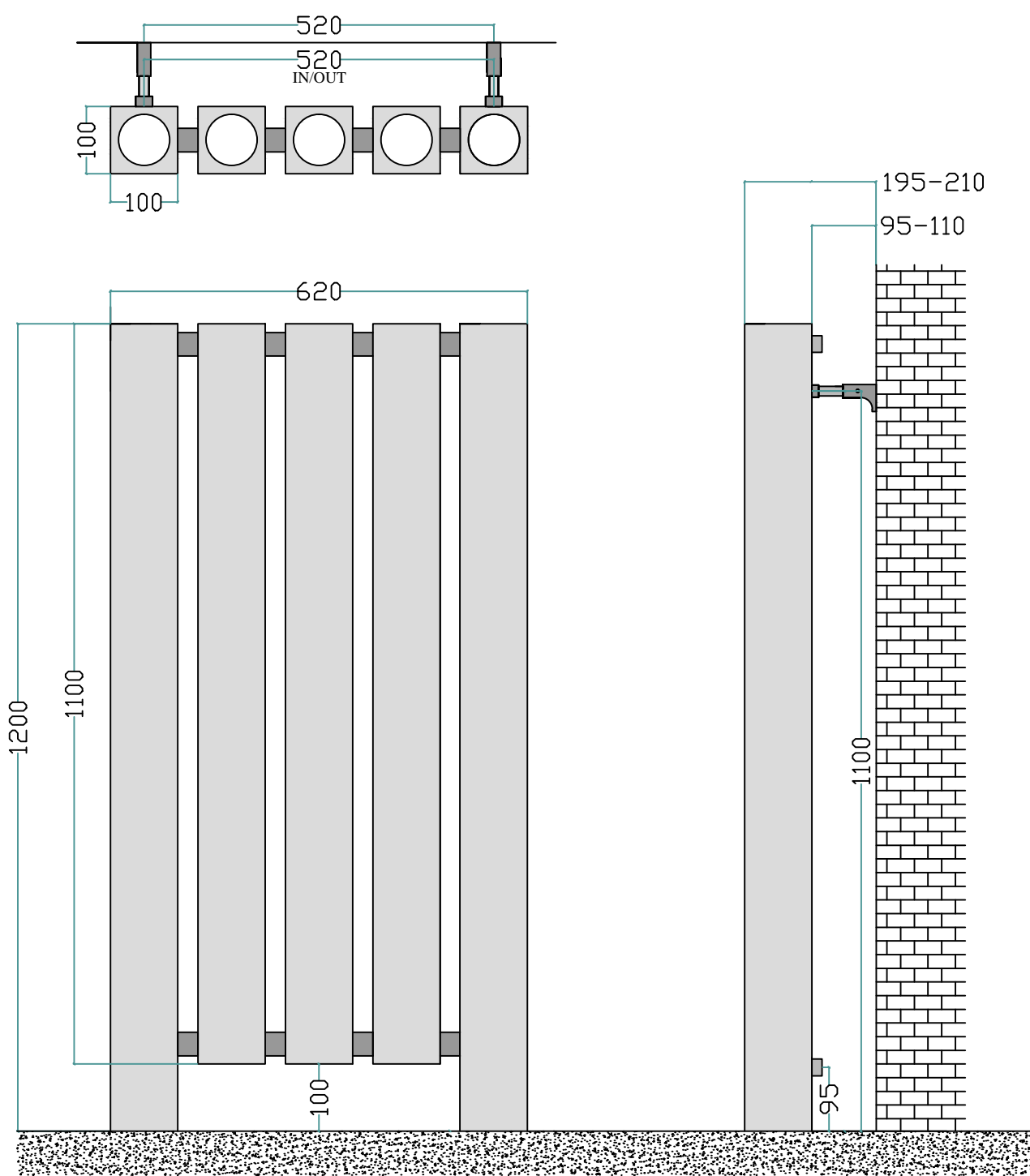

KORLE	Watt	BTU	Watt	BTU
	$\Delta 50^{\circ}\text{C}$	$\Delta 50^{\circ}\text{C}$	$\Delta 60^{\circ}\text{C}$	$\Delta 60^{\circ}\text{C}$
Cannon 120XL05	1320	4506	1669	5698

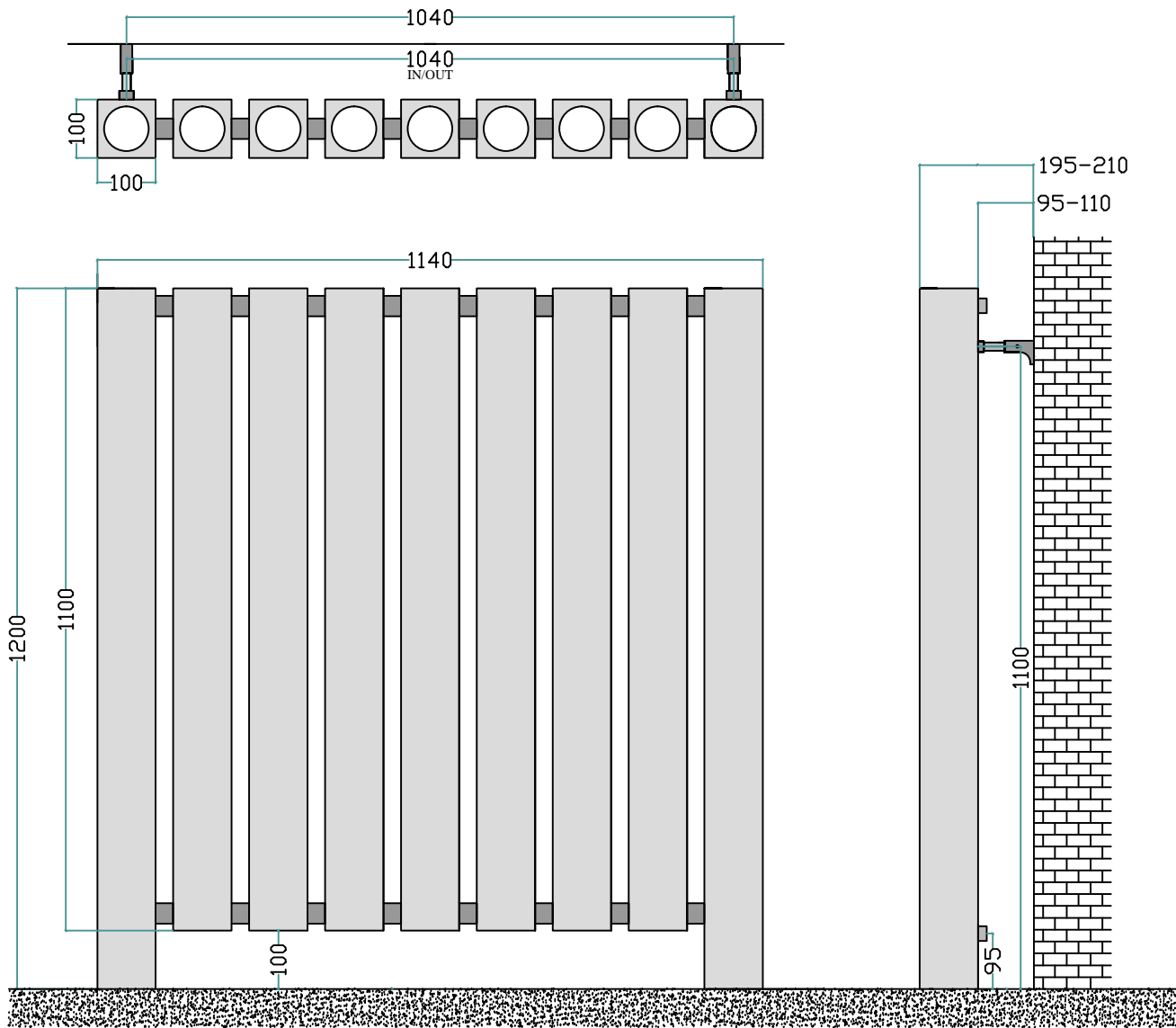

KORLE	Watt	BTU	Watt	BTU
	Δ 50°C	Δ 50°C	Δ 60°C	Δ 60°C
Cannon 120XL09	2339	7984	2958	10096

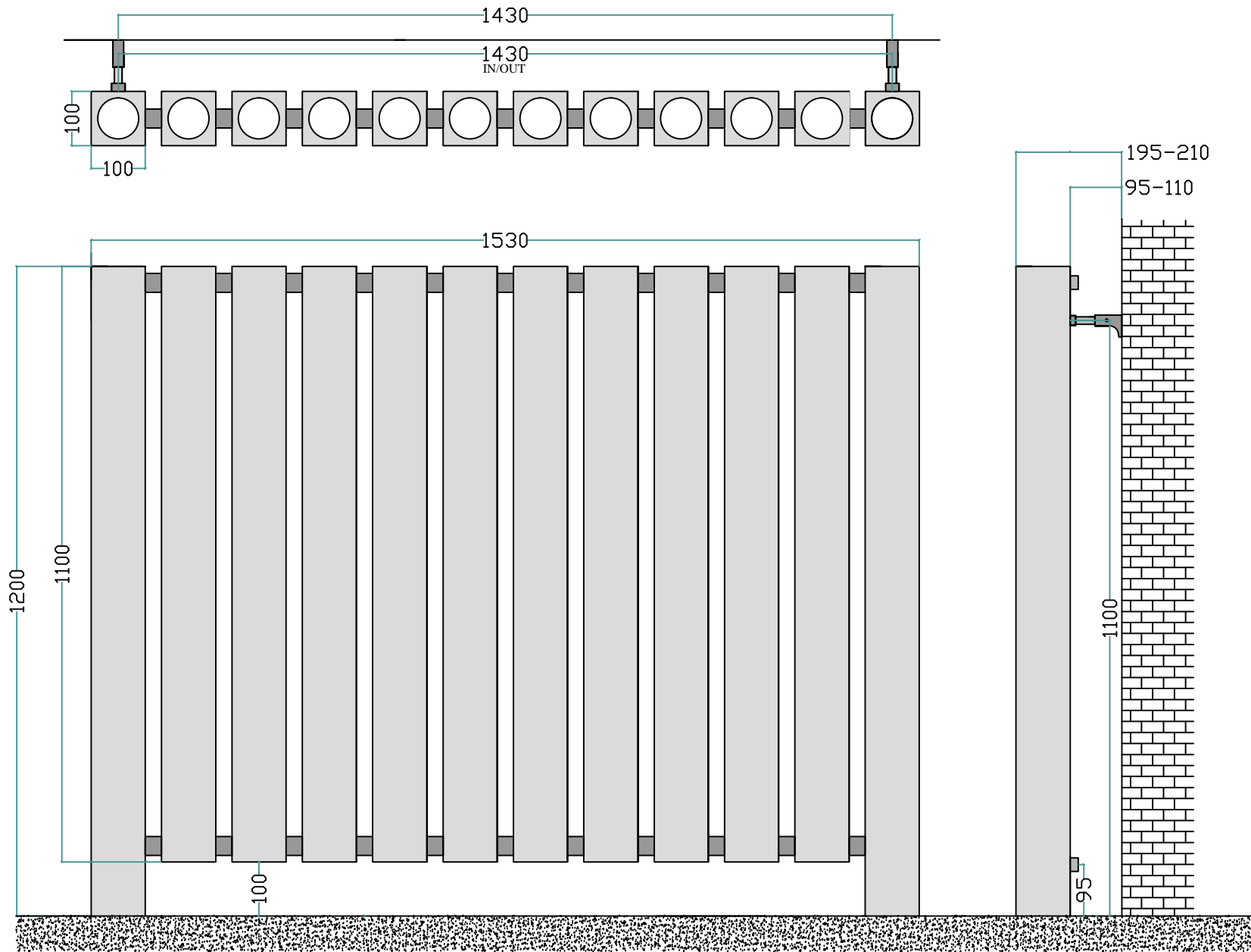

Cannon 120XL12

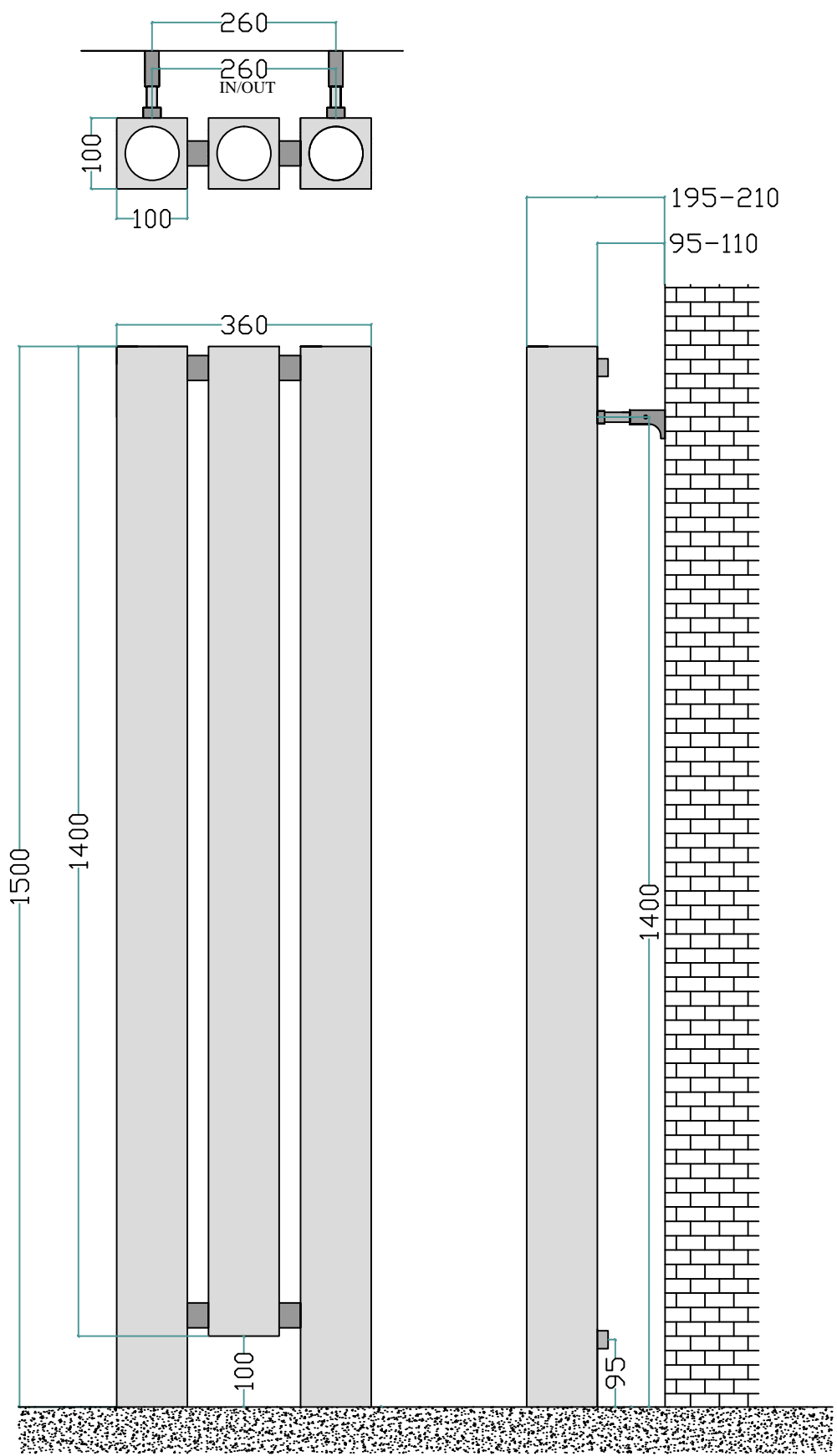

KORLE	Watt	BTU	Watt	BTU
	$\Delta 50^{\circ}\text{C}$	$\Delta 50^{\circ}\text{C}$	$\Delta 60^{\circ}\text{C}$	$\Delta 60^{\circ}\text{C}$
Cannon 150XL03	1019	3478	1289	4398

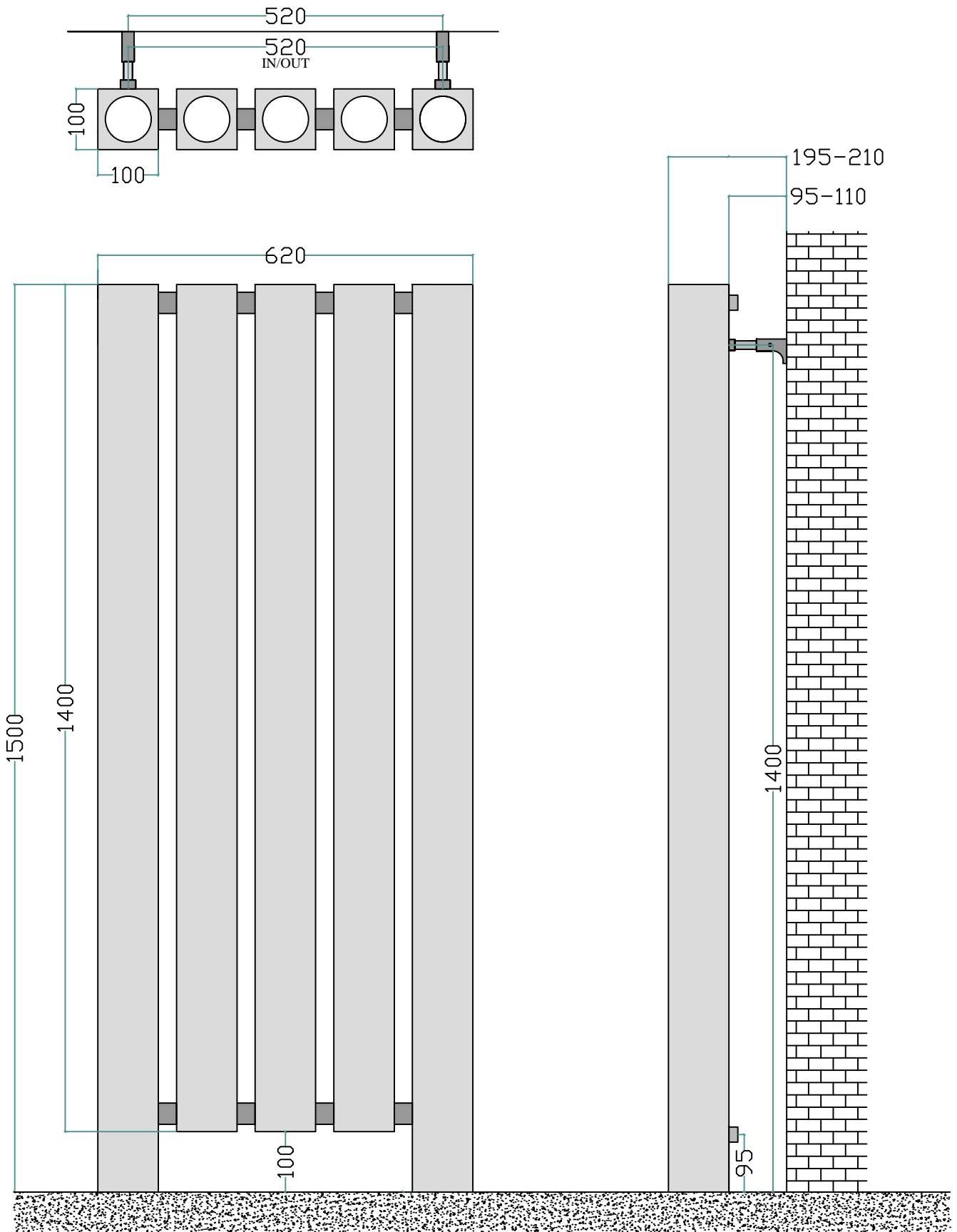

KORLE	Watt	BTU	Watt	BTU
	$\Delta 50^{\circ}\text{C}$	$\Delta 50^{\circ}\text{C}$	$\Delta 60^{\circ}\text{C}$	$\Delta 60^{\circ}\text{C}$
Cannon 150XL05	1668	5692	2109	7197

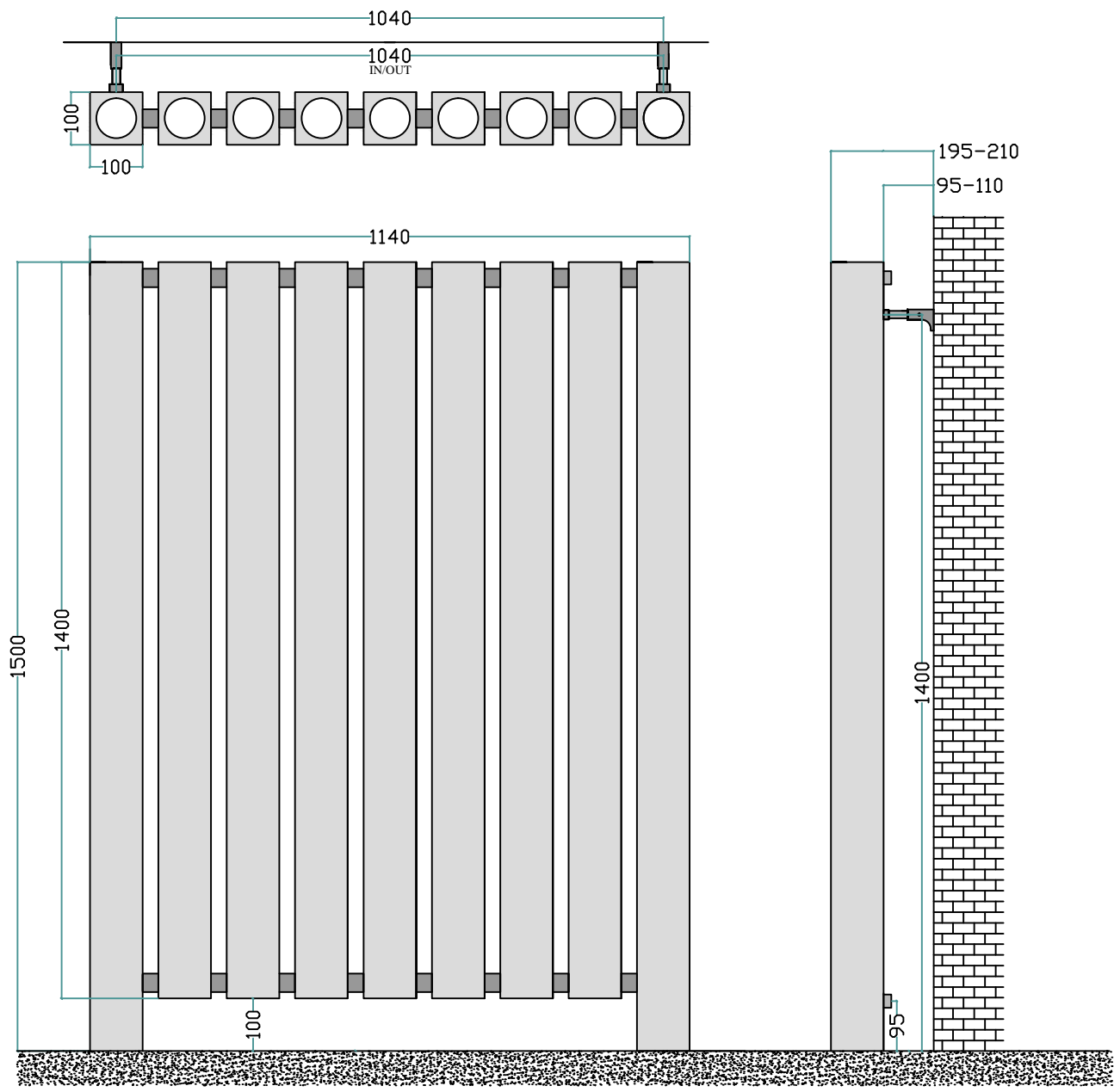

Cannon 150XL09

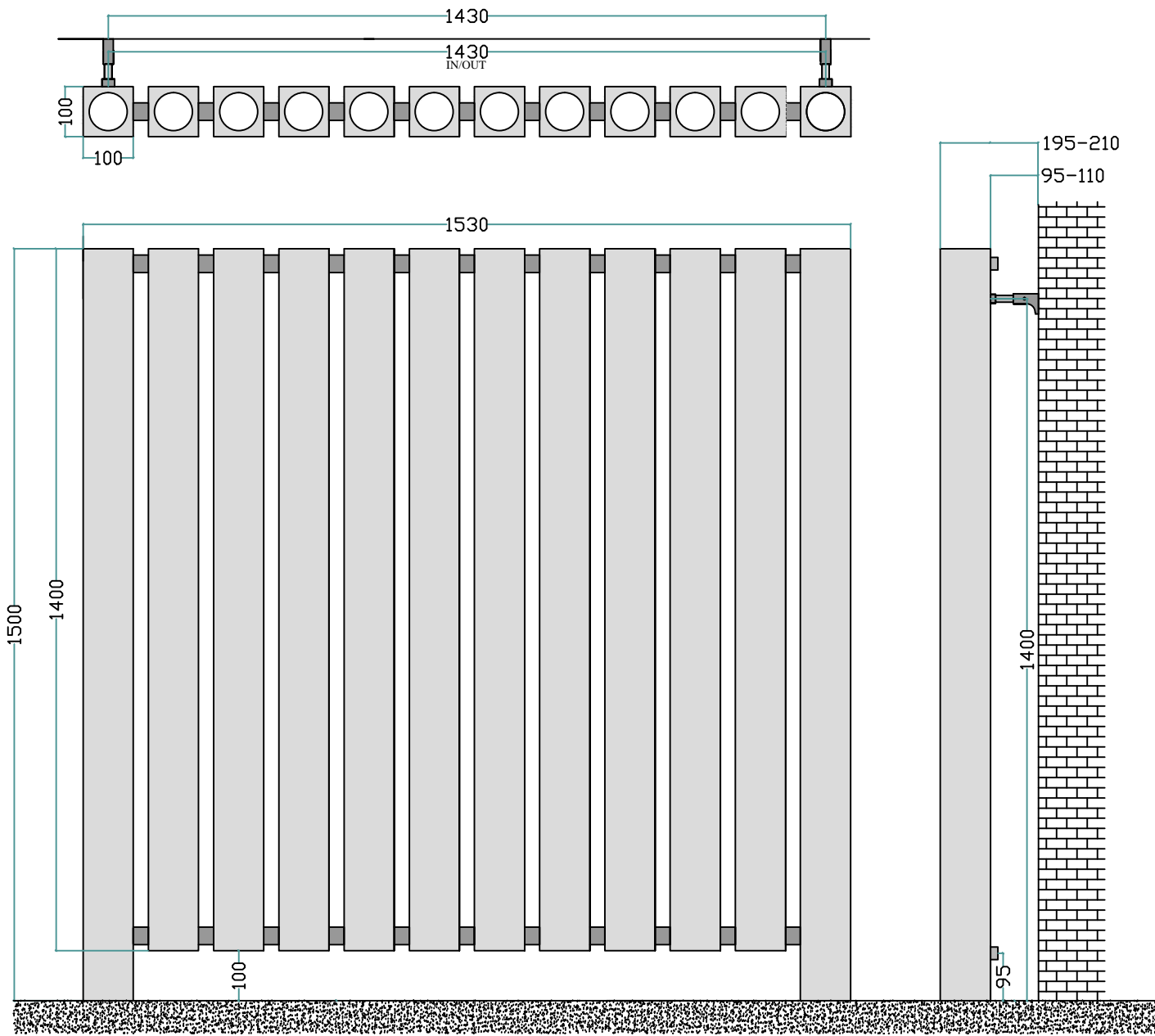

Cannon 150XL12

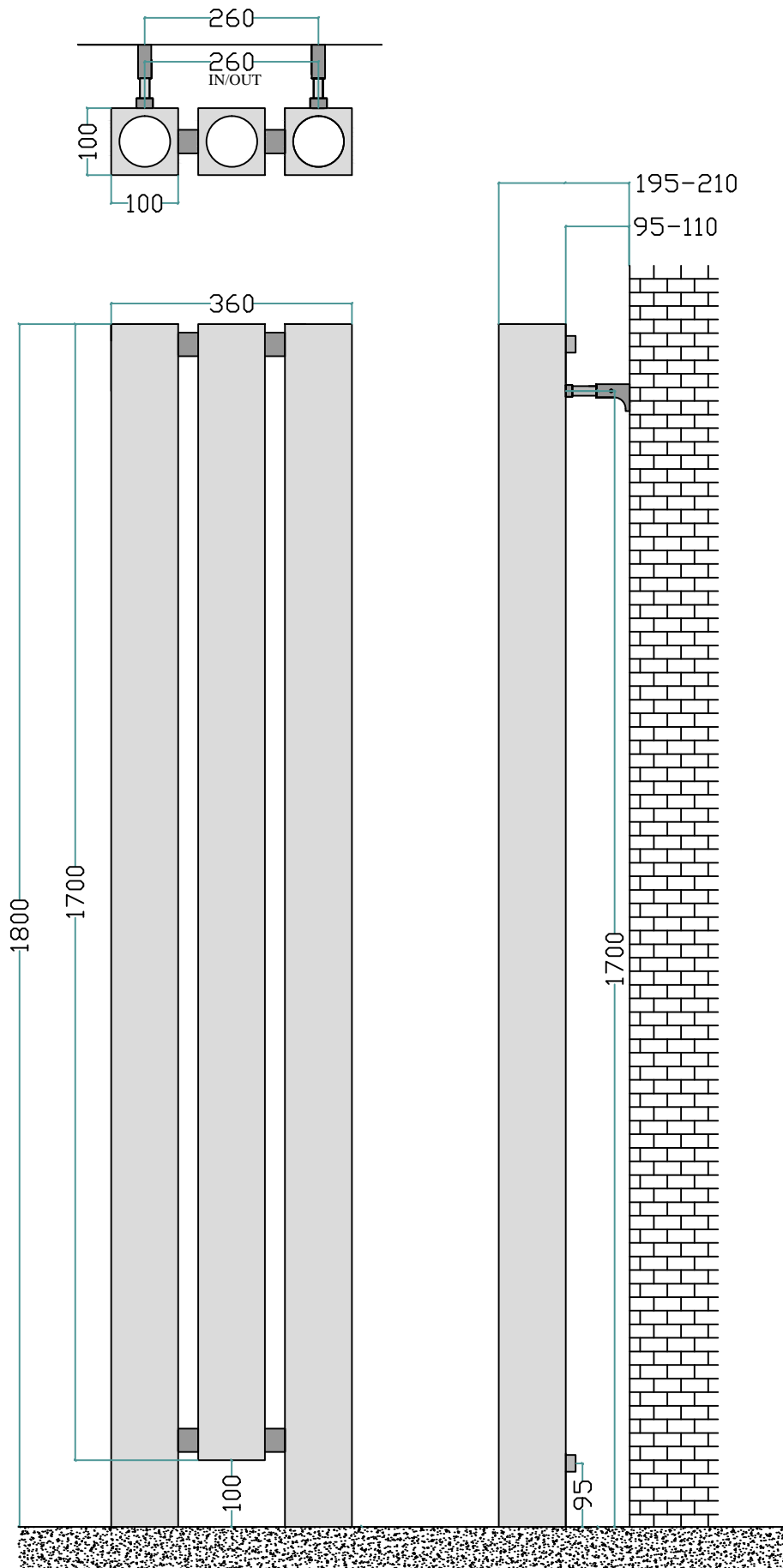

KORLE	Watt	BTU	Watt	BTU
	$\Delta 50^{\circ}\text{C}$	$\Delta 50^{\circ}\text{C}$	$\Delta 60^{\circ}\text{C}$	$\Delta 60^{\circ}\text{C}$
Cannon 180XL03	1227	4190	1552	5298

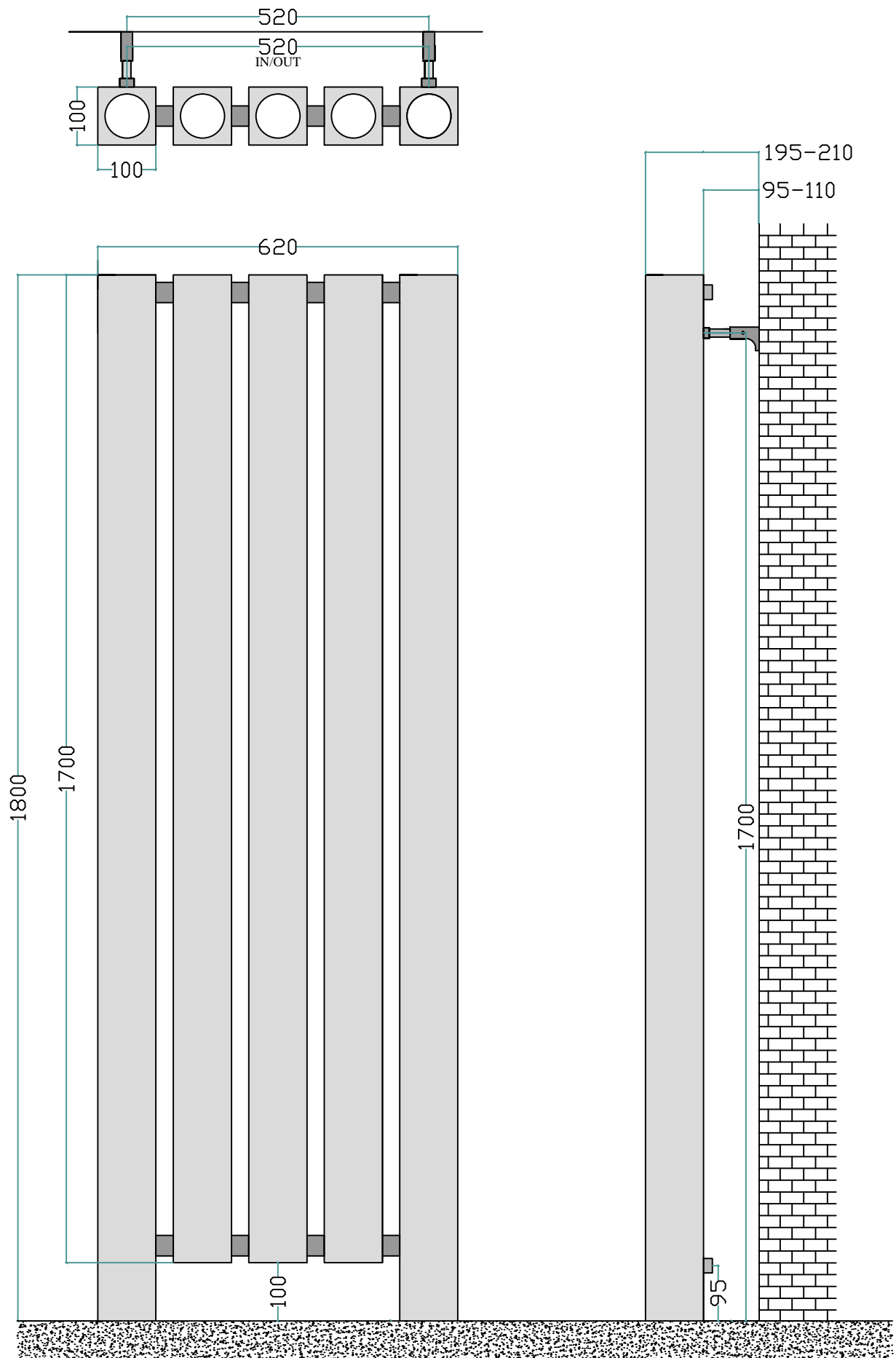

KORLE	Watt	BTU	Watt	BTU
	Δ 50°C	Δ 50°C	Δ 60°C	Δ 60°C
Cannon 180XL05	2015	6877	2548	8696

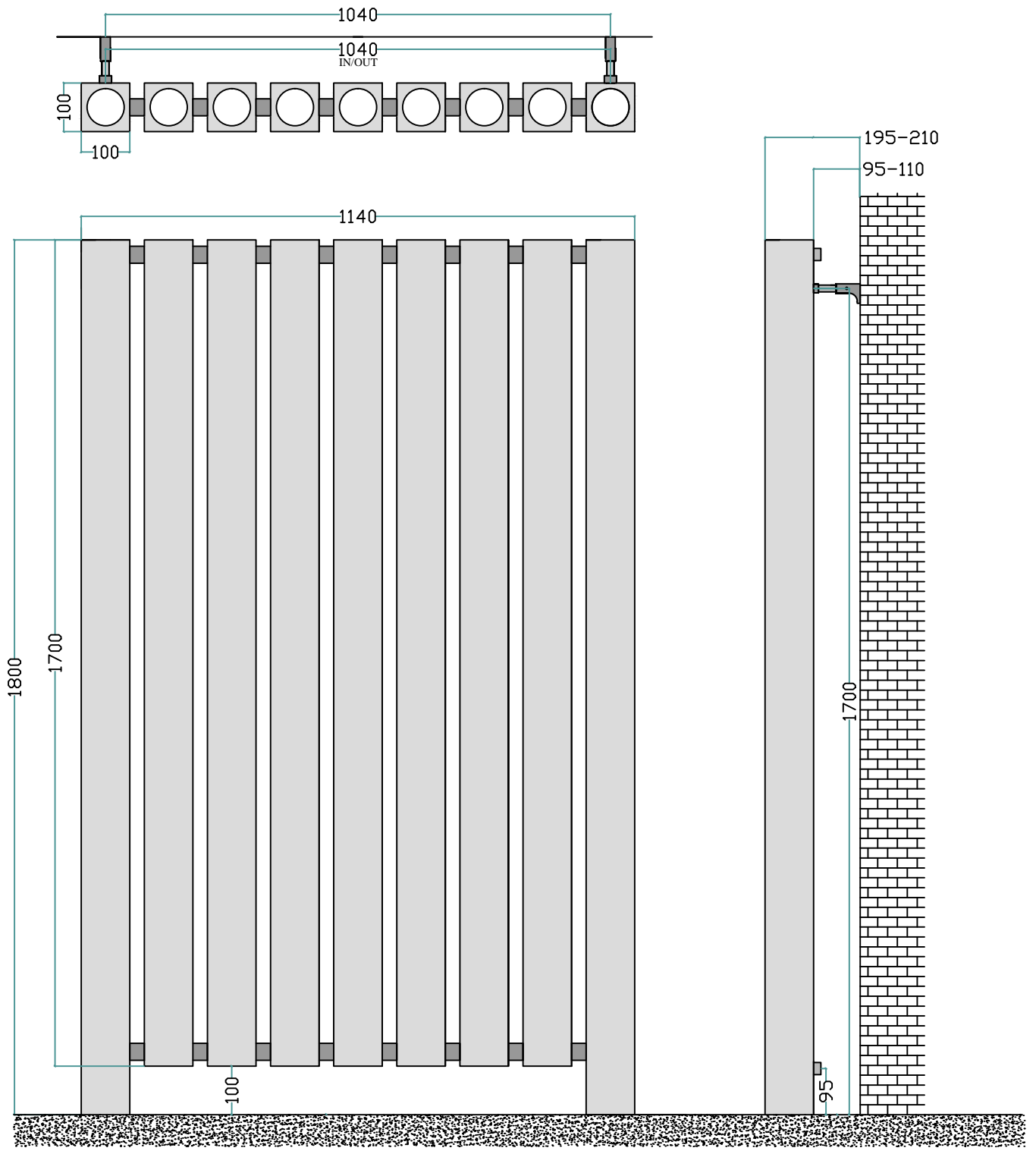

Cannon 180XL09

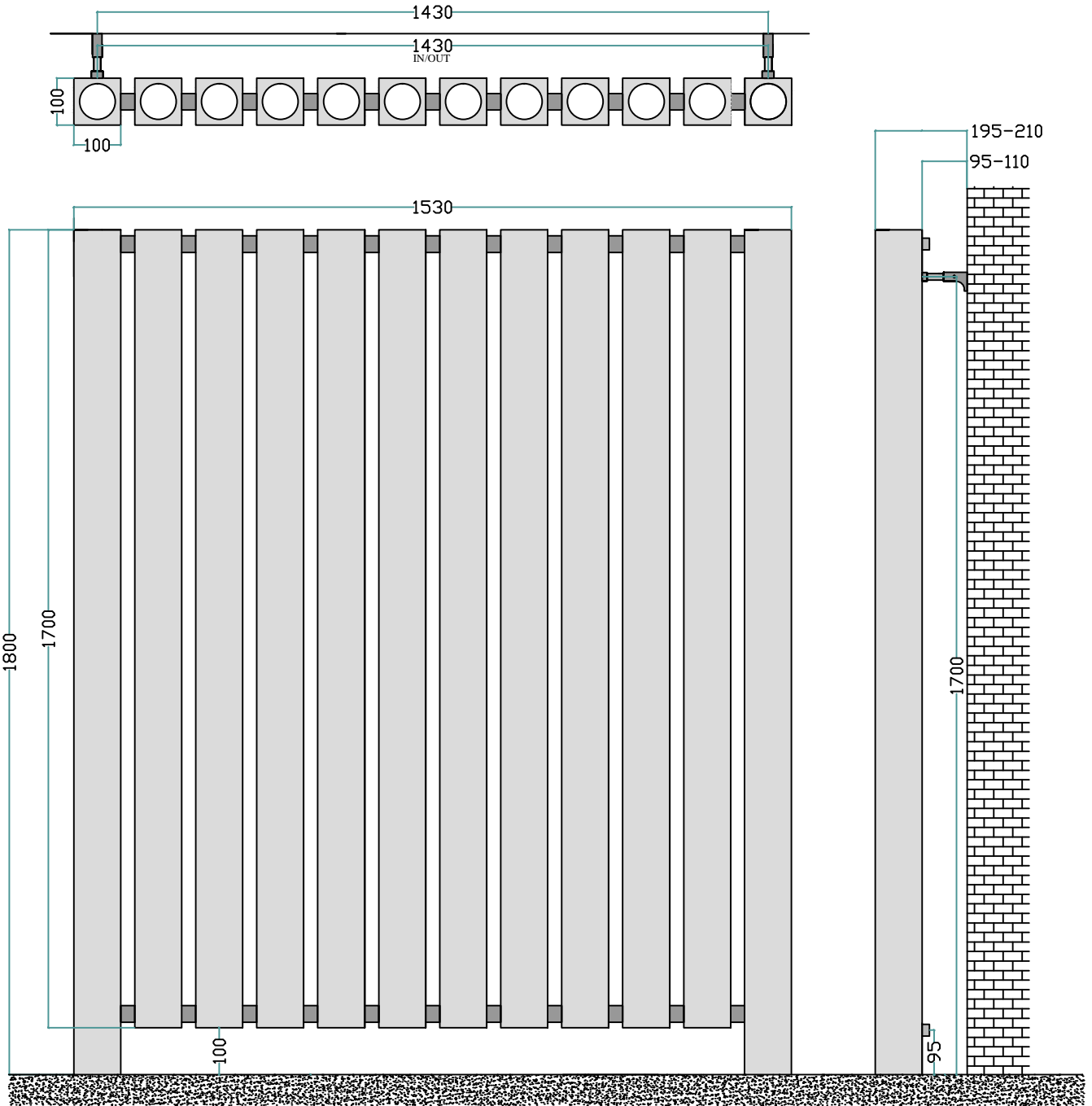

Cannon 180XL12

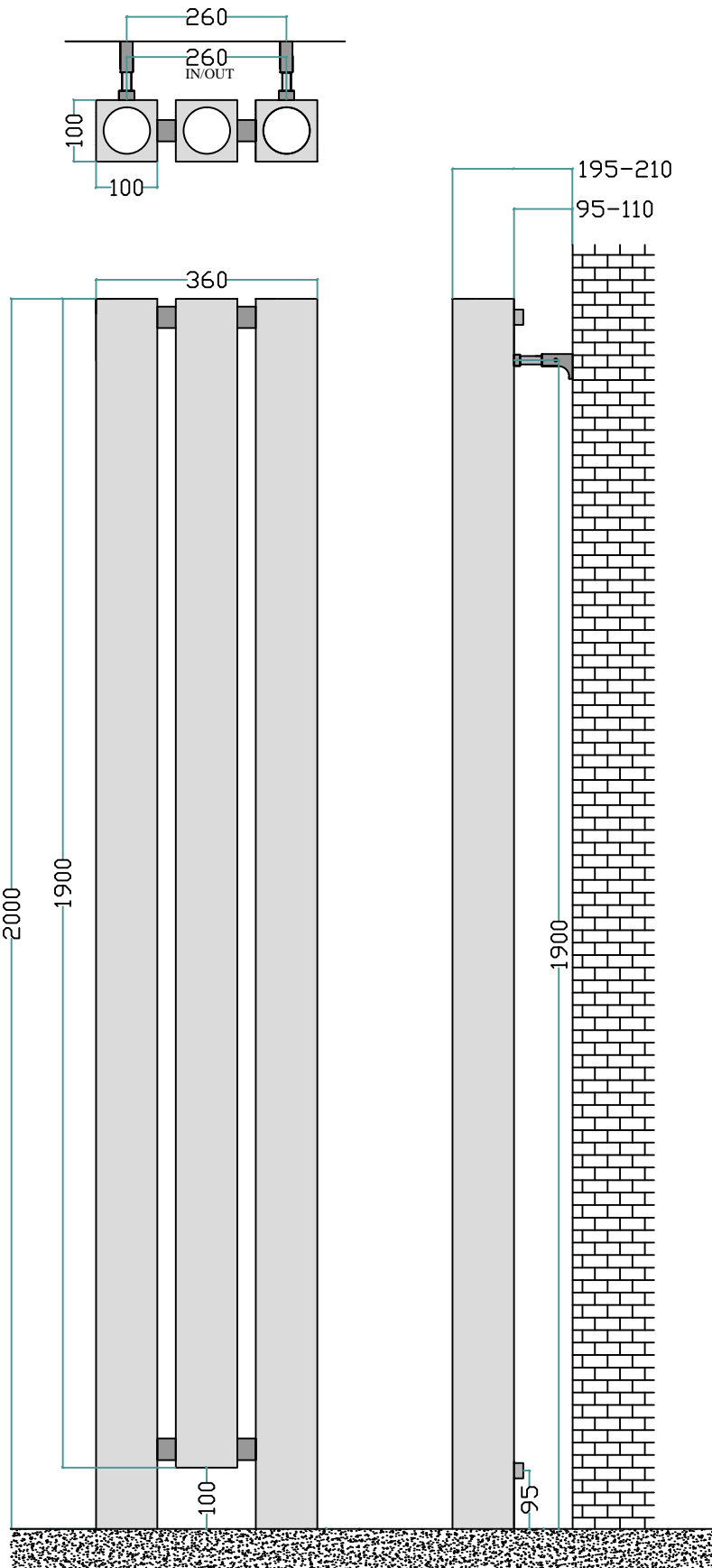

KORLE	Watt	BTU	Watt	BTU
	$\Delta 50^{\circ}\text{C}$	$\Delta 50^{\circ}\text{C}$	$\Delta 60^{\circ}\text{C}$	$\Delta 60^{\circ}\text{C}$
Cannon 200XL03	1366	4664	1728	5898

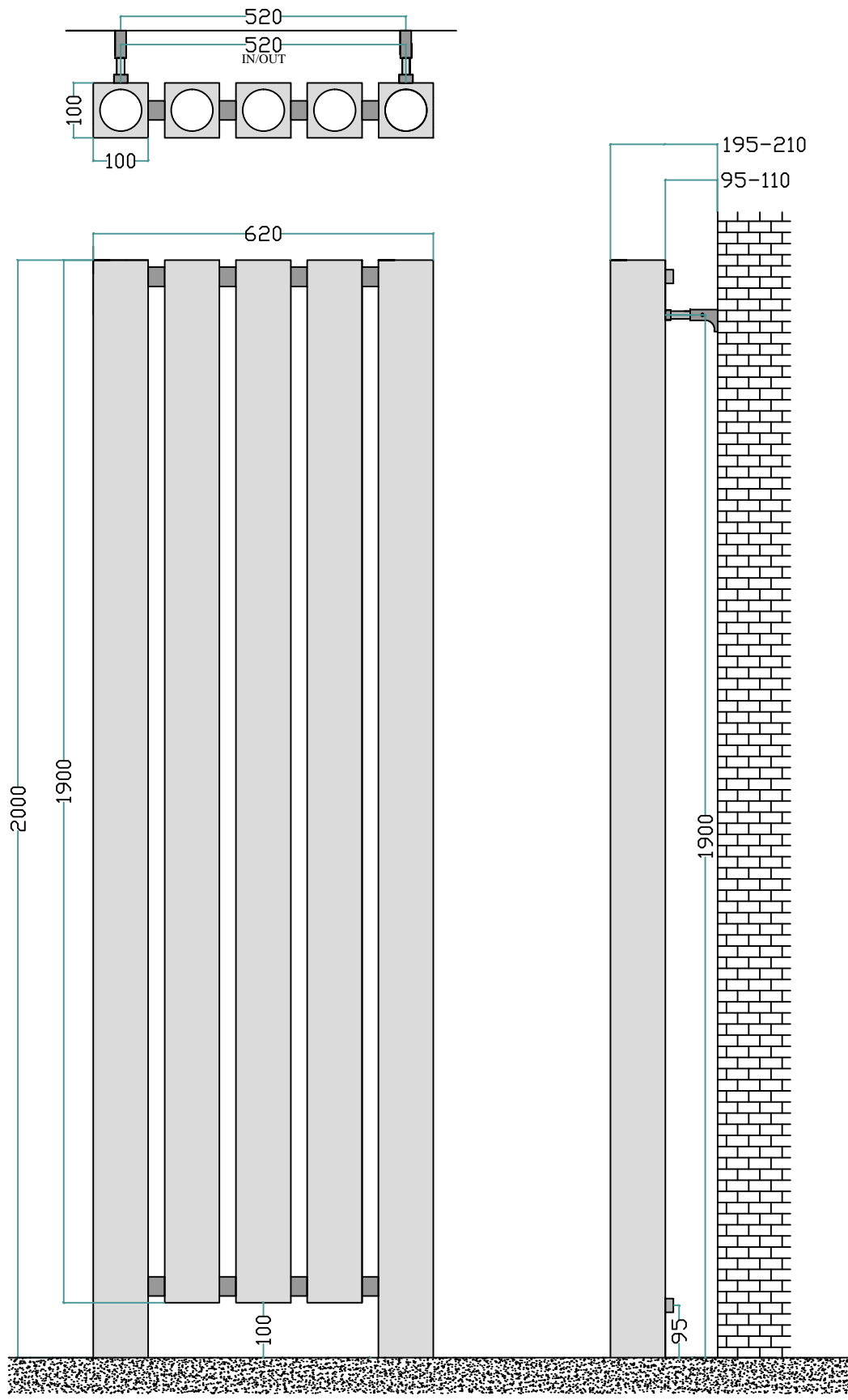

KORLE Cannon 200XL05	Watt	BTU	Watt	BTU
	$\Delta 50^{\circ}\text{C}$	$\Delta 50^{\circ}\text{C}$	$\Delta 60^{\circ}\text{C}$	$\Delta 60^{\circ}\text{C}$
	2247	7668	2841	9696

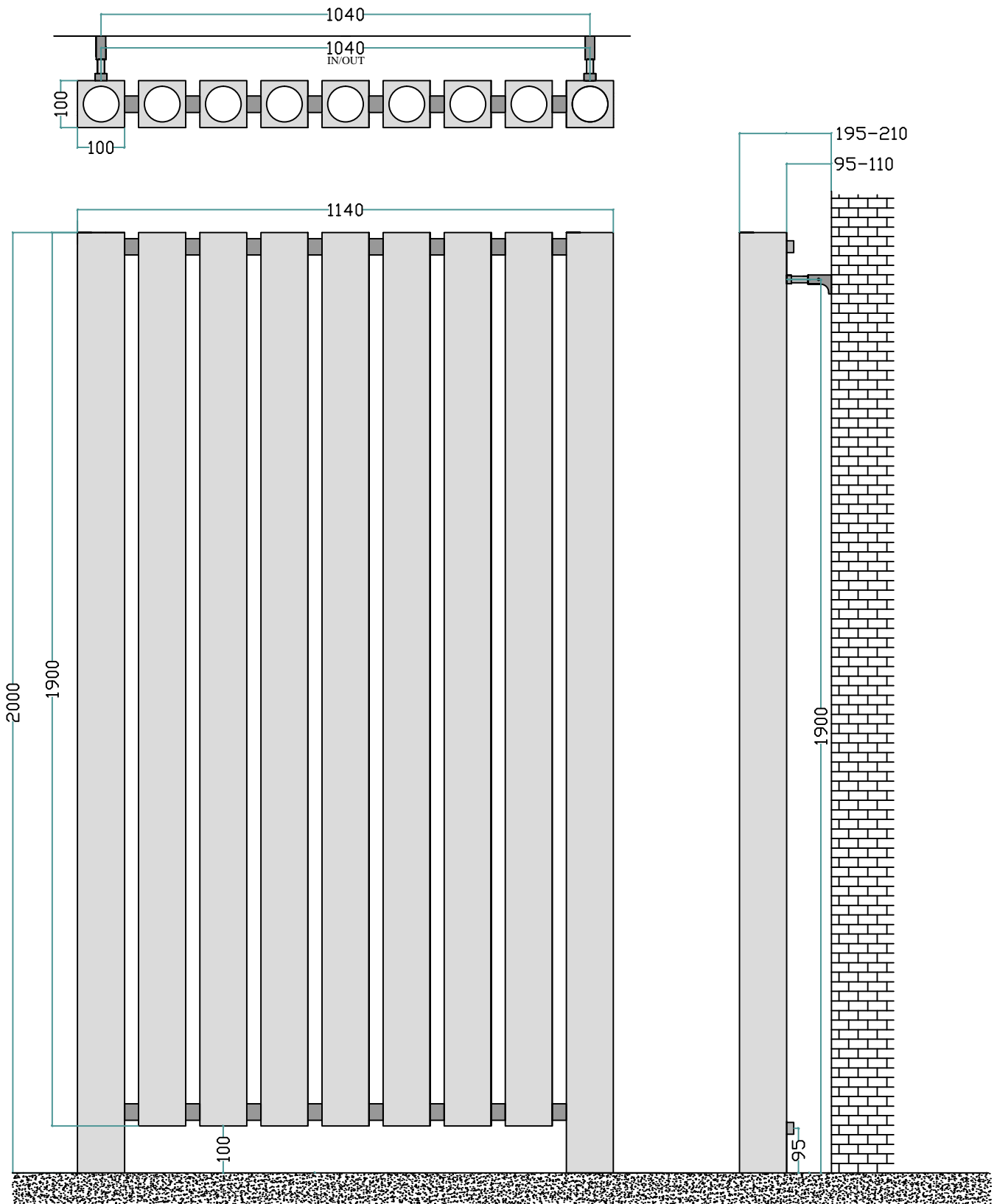

Cannon 200XL09

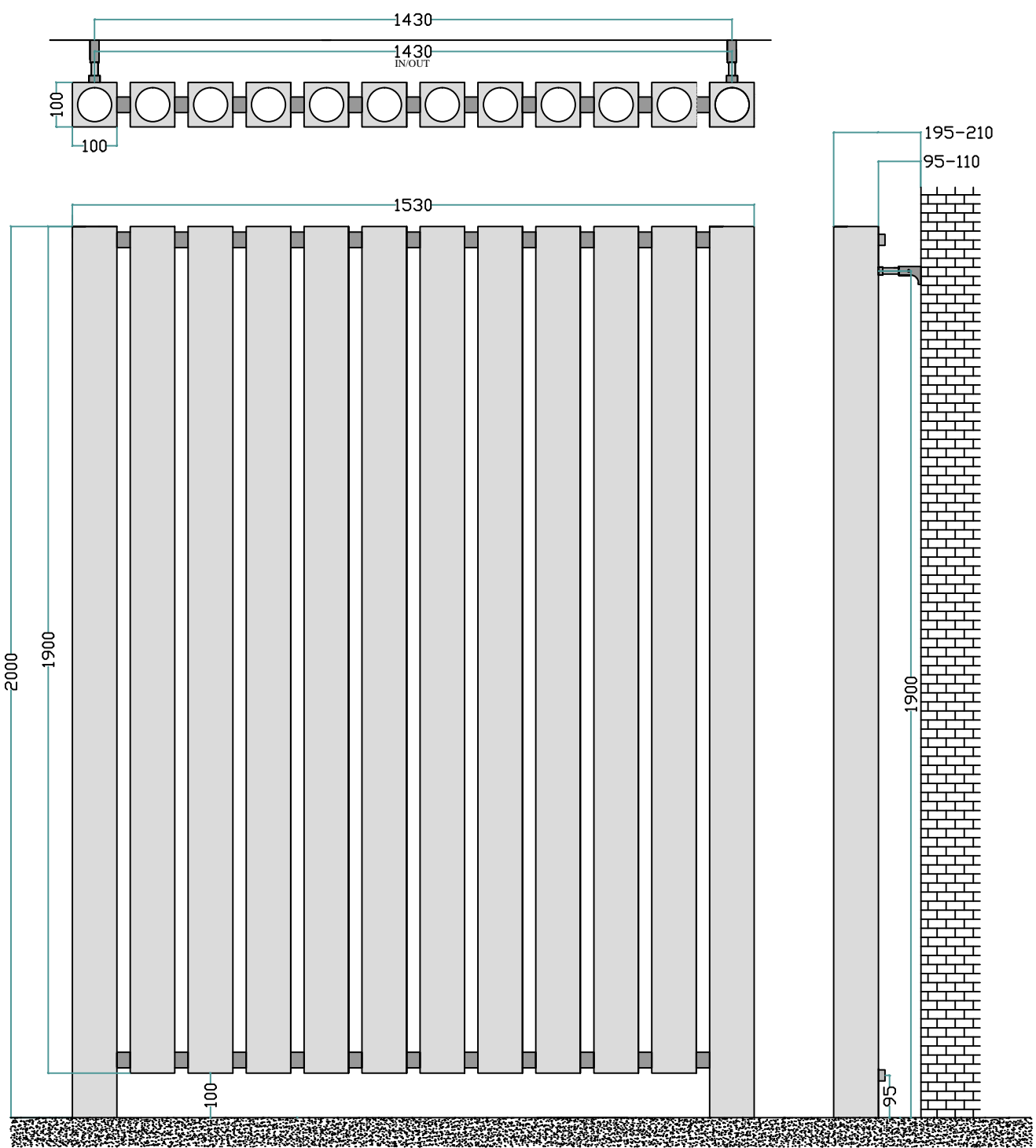

Cannon 200XL12

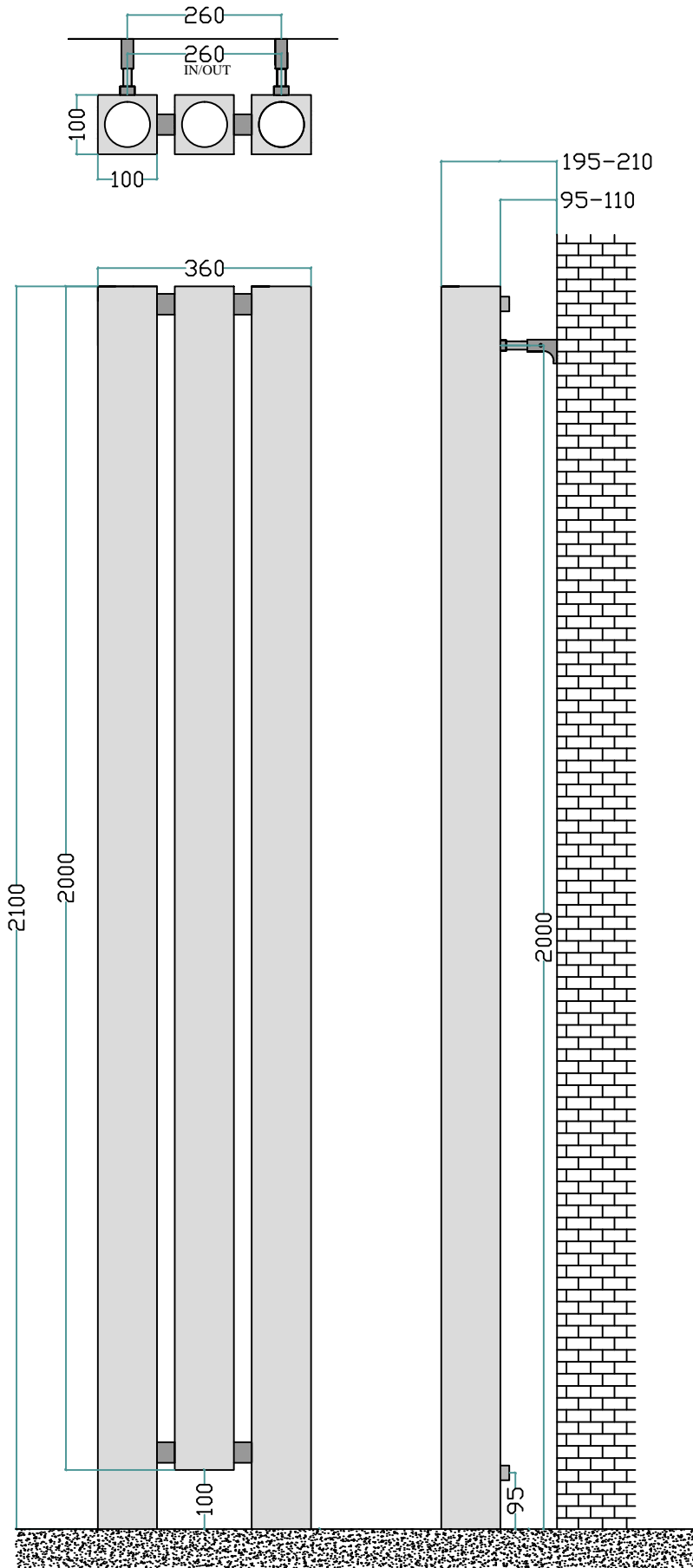

Cannon 210XL03

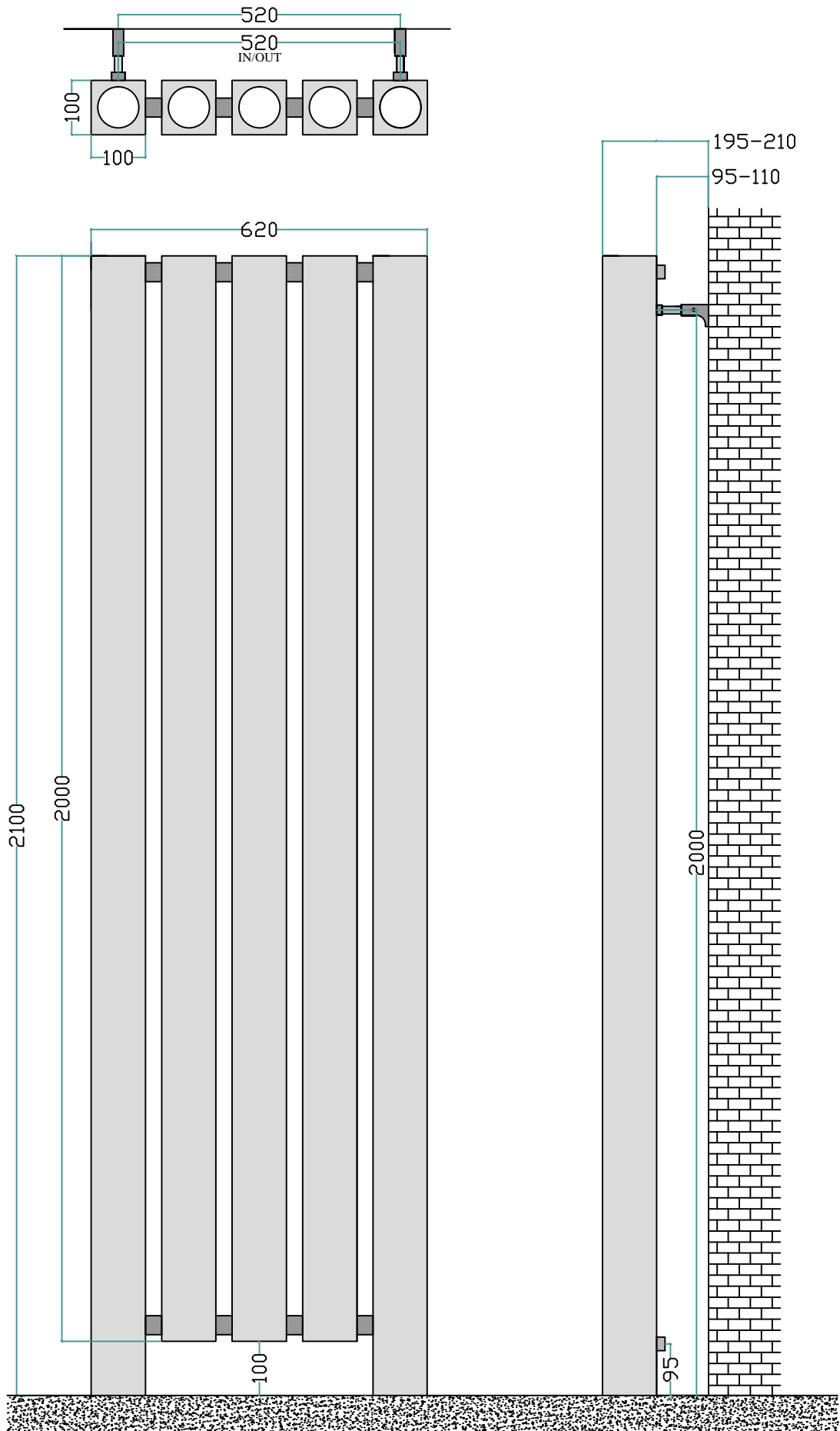

Cannon 210XL05

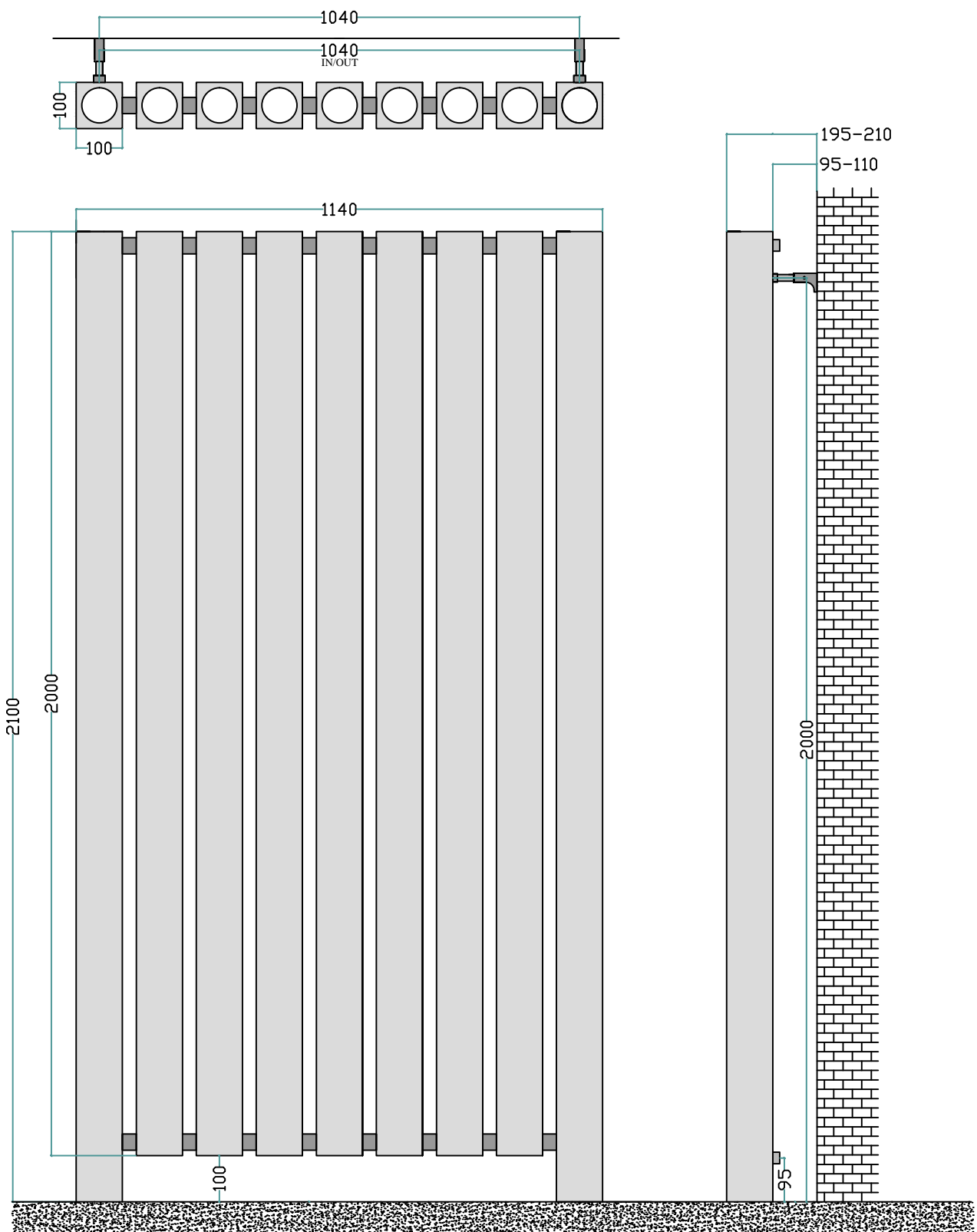

Cannon 210XL09

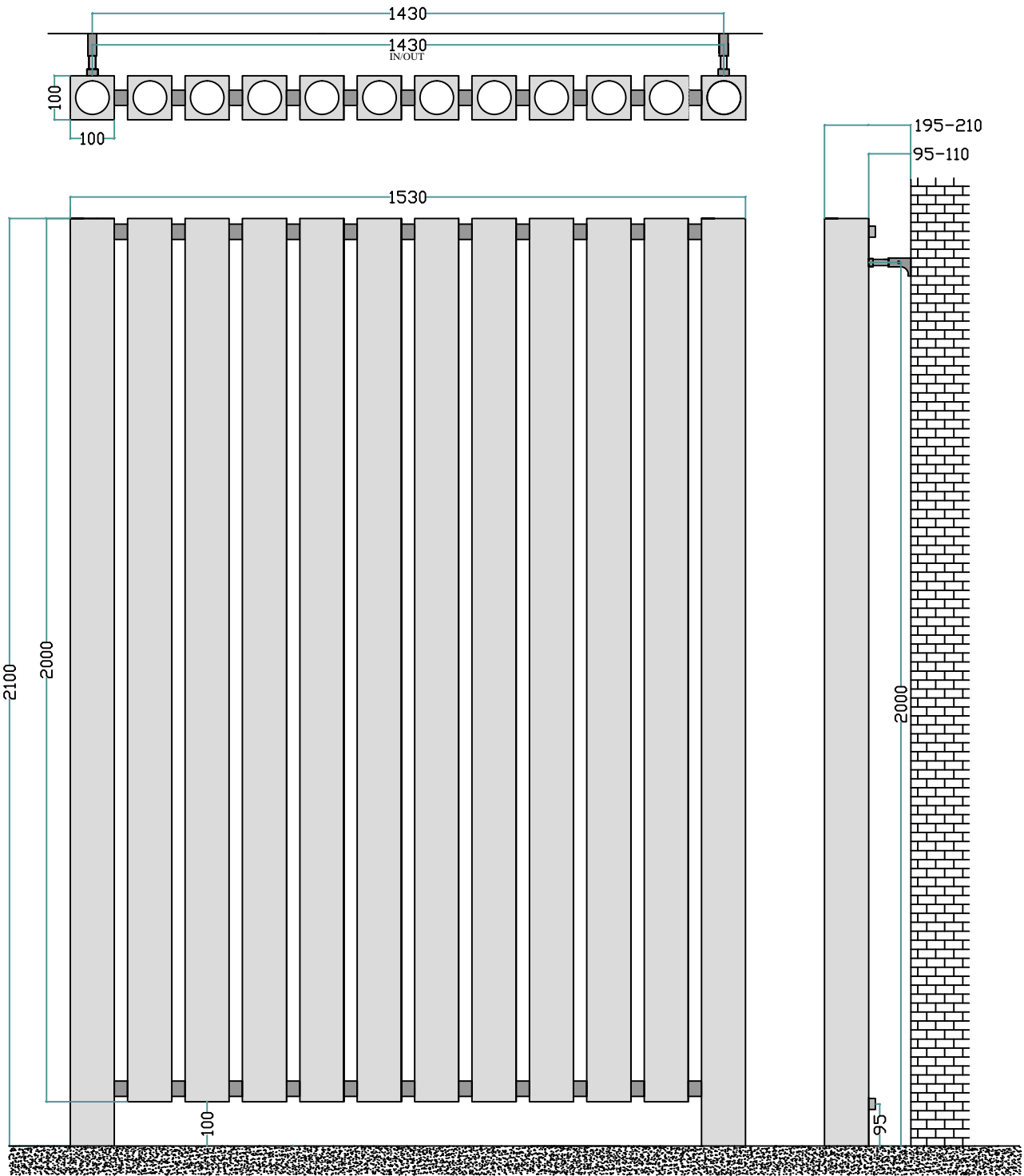

Cannon 210XL12