

KORLE	Watt	BTU	Watt	BTU
	Δ 50°C	Δ 50°C	Δ 60°C	Δ 60°C
Cadence 30M20	264	902	334	1141

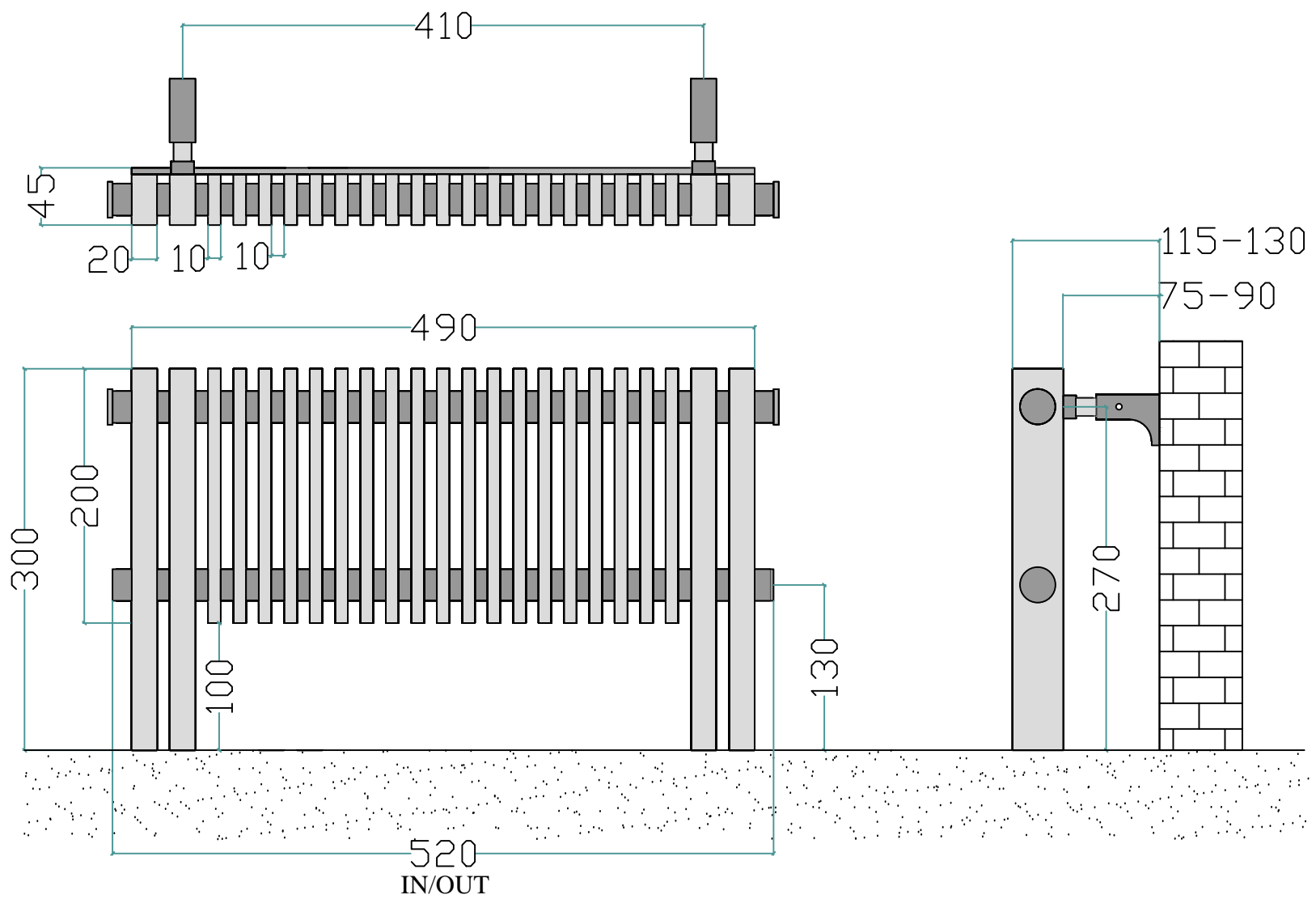

KORLE	Watt	BTU	Watt	BTU
	$\Delta 50^{\circ}\text{C}$	$\Delta 50^{\circ}\text{C}$	$\Delta 60^{\circ}\text{C}$	$\Delta 60^{\circ}\text{C}$
Cadence 30M23	299	1019	378	1289

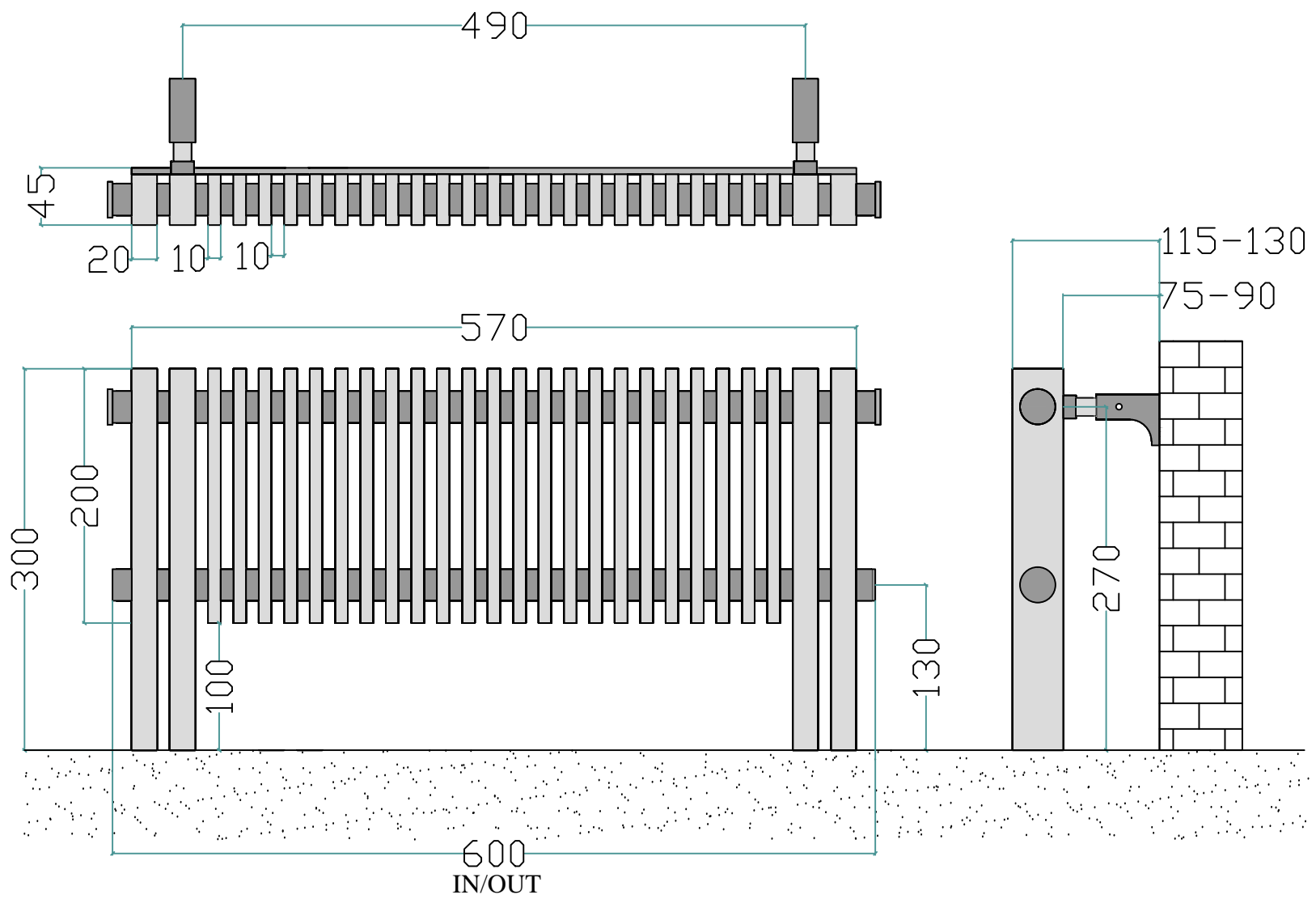

KORLE	Watt	BTU	Watt	BTU
	$\Delta 50^{\circ}\text{C}$	$\Delta 50^{\circ}\text{C}$	$\Delta 60^{\circ}\text{C}$	$\Delta 60^{\circ}\text{C}$
Cadence 30M27	344	1175	435	1486

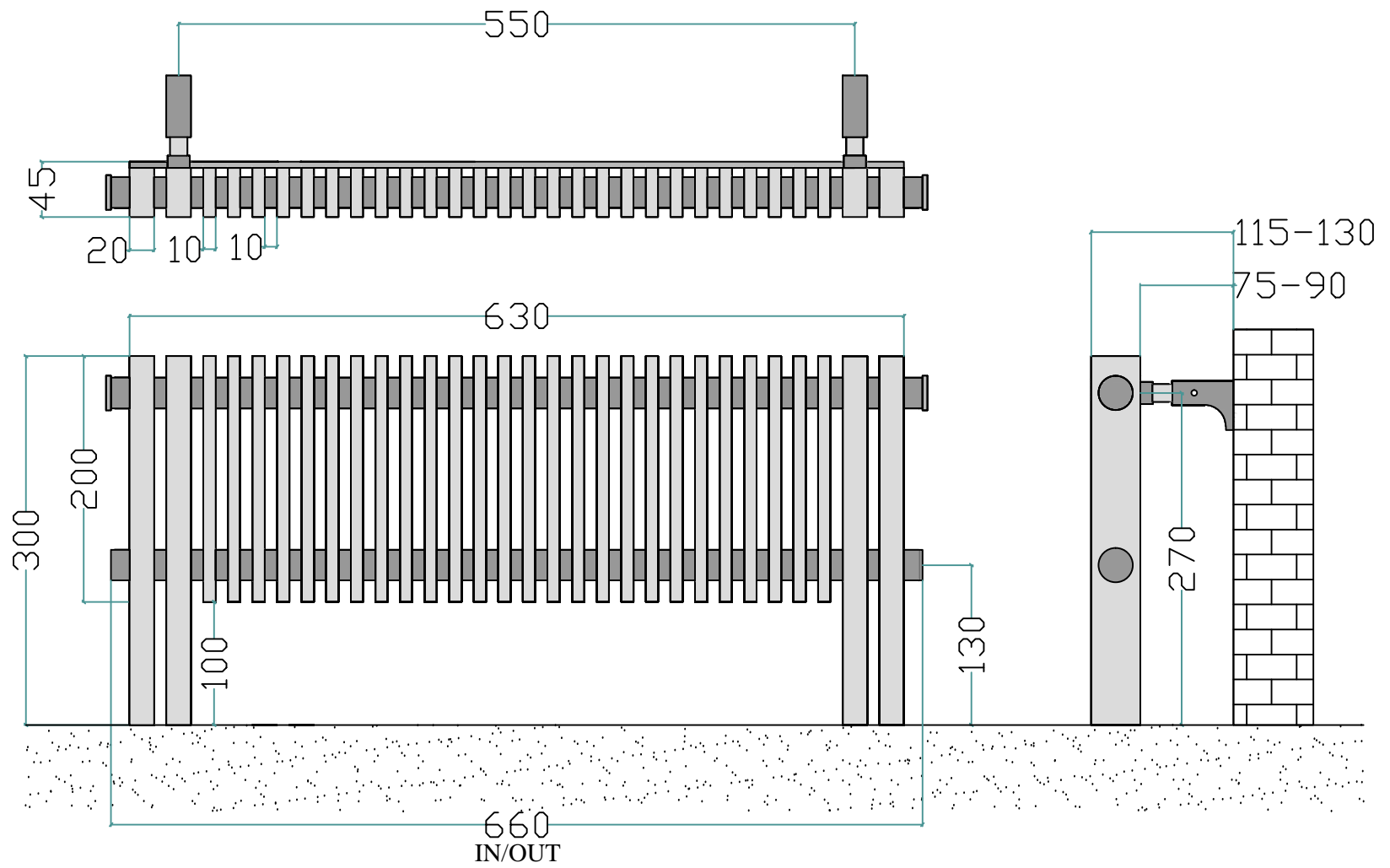

KORLE	Watt Δ 50°C	BTU Δ 50°C	Watt Δ 60°C	BTU Δ 60°C
Cadence 30M30	378	1291	479	1633

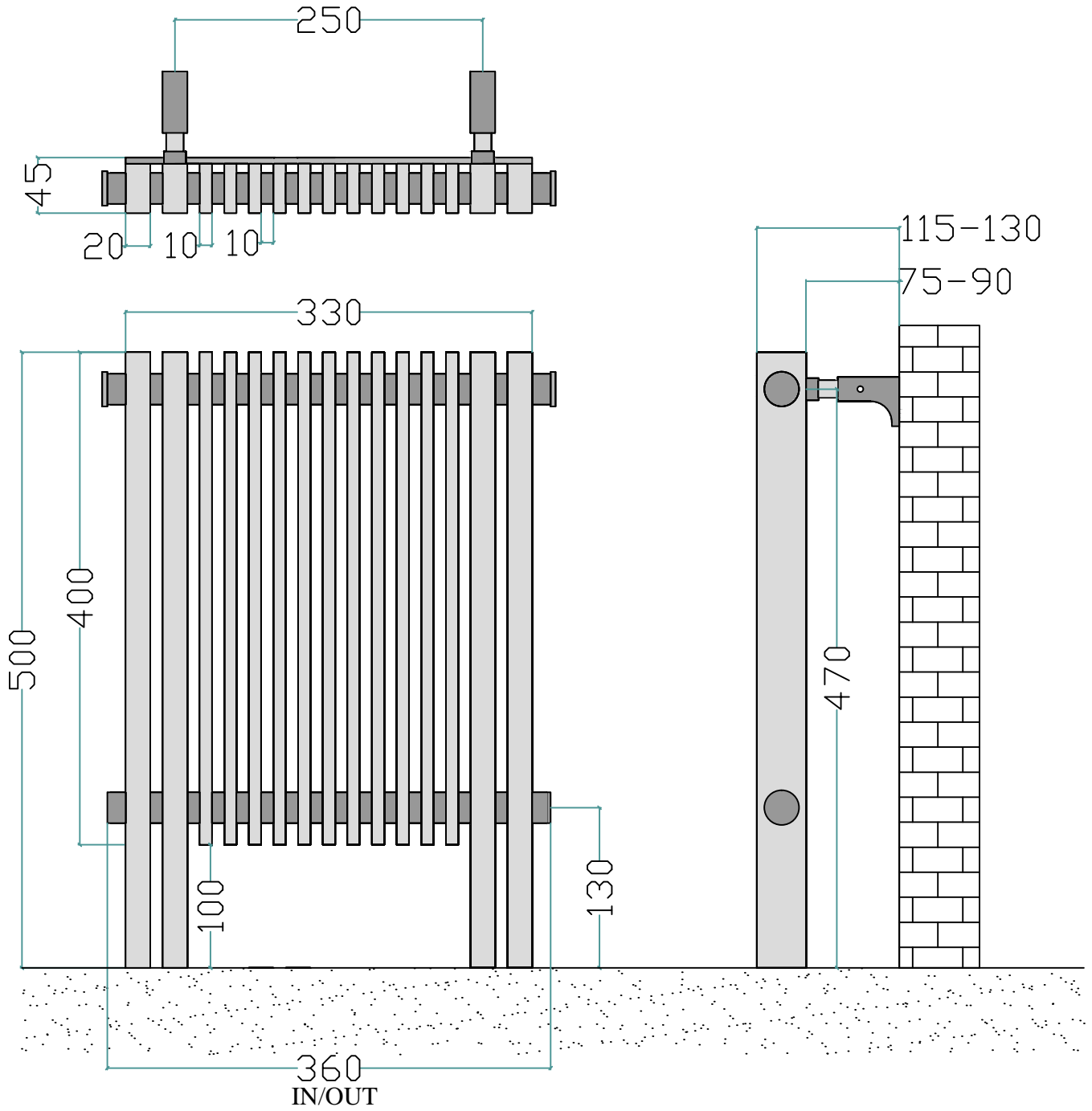

KORLE	Watt	BTU	Watt	BTU
	$\Delta 50^{\circ}\text{C}$	$\Delta 50^{\circ}\text{C}$	$\Delta 60^{\circ}\text{C}$	$\Delta 60^{\circ}\text{C}$
Cadence 50M15	388	1323	490	1672

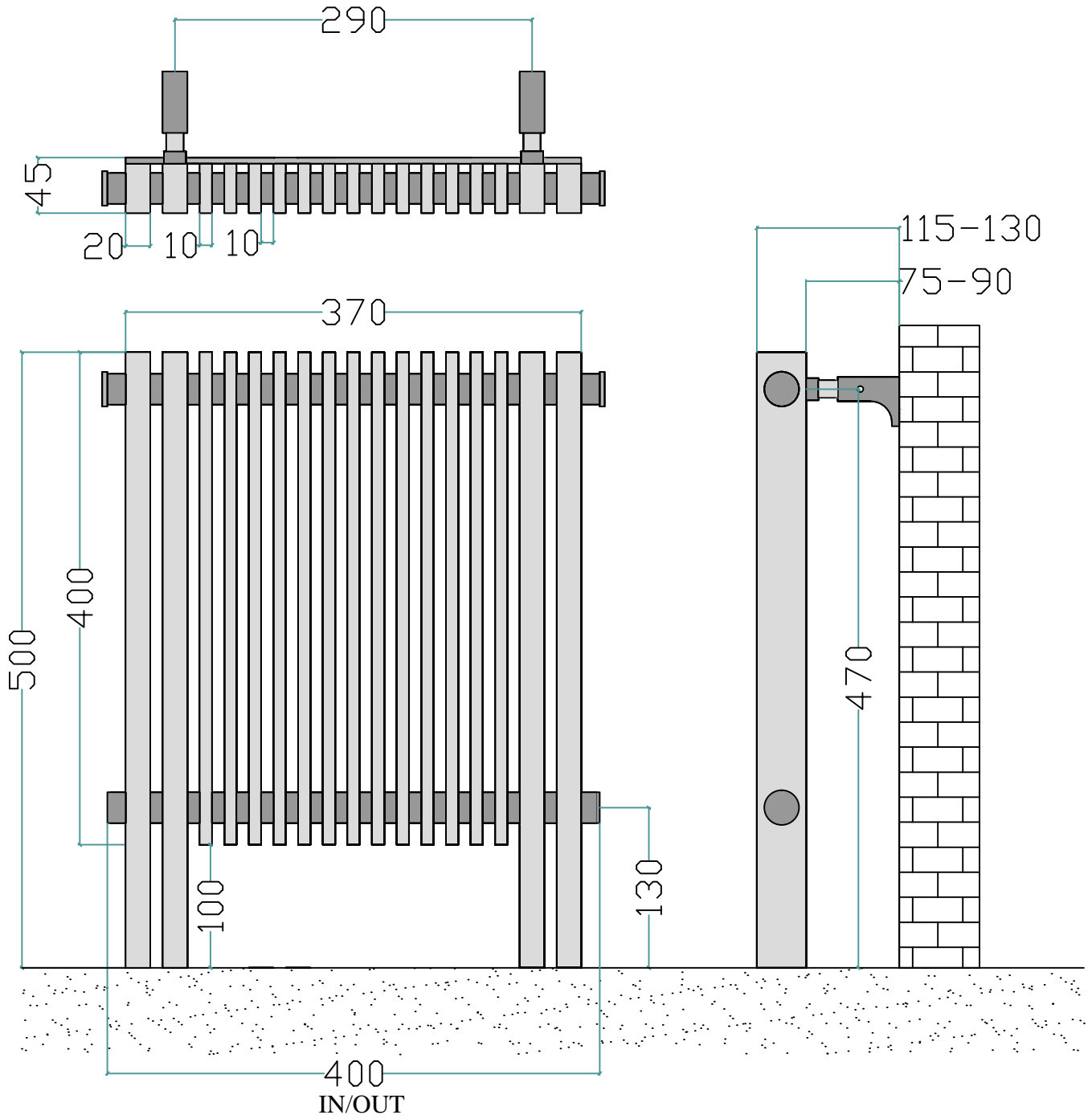

KORLE	Watt	BTU	Watt	BTU
	$\Delta 50^{\circ}\text{C}$	$\Delta 50^{\circ}\text{C}$	$\Delta 60^{\circ}\text{C}$	$\Delta 60^{\circ}\text{C}$
Cadence 50M17	433	1478	548	1869

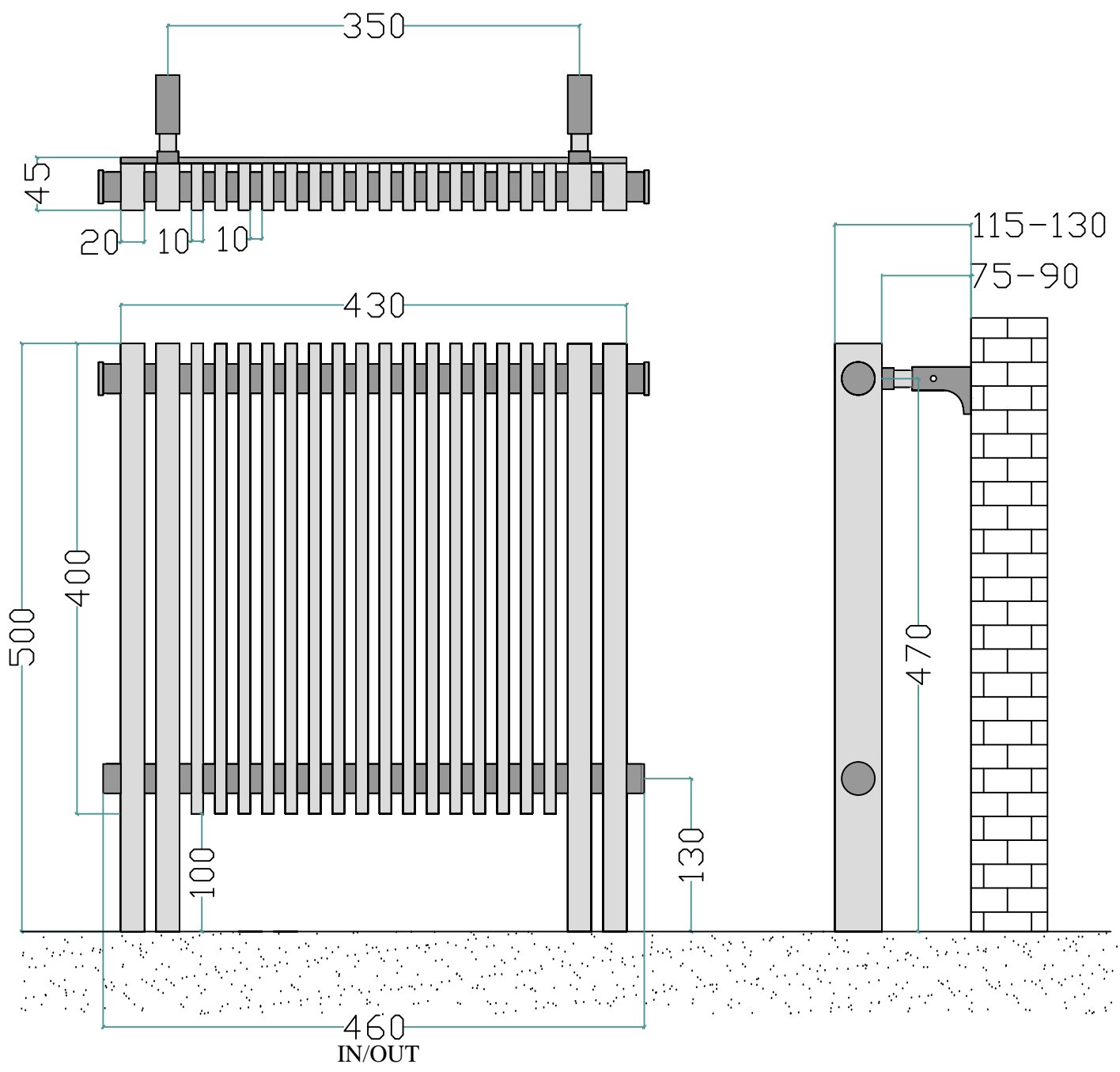

KORLE	Watt	BTU	Watt	BTU
	$\Delta 50^{\circ}\text{C}$	$\Delta 50^{\circ}\text{C}$	$\Delta 60^{\circ}\text{C}$	$\Delta 60^{\circ}\text{C}$
Cadence 50M20	502	1712	634	2164

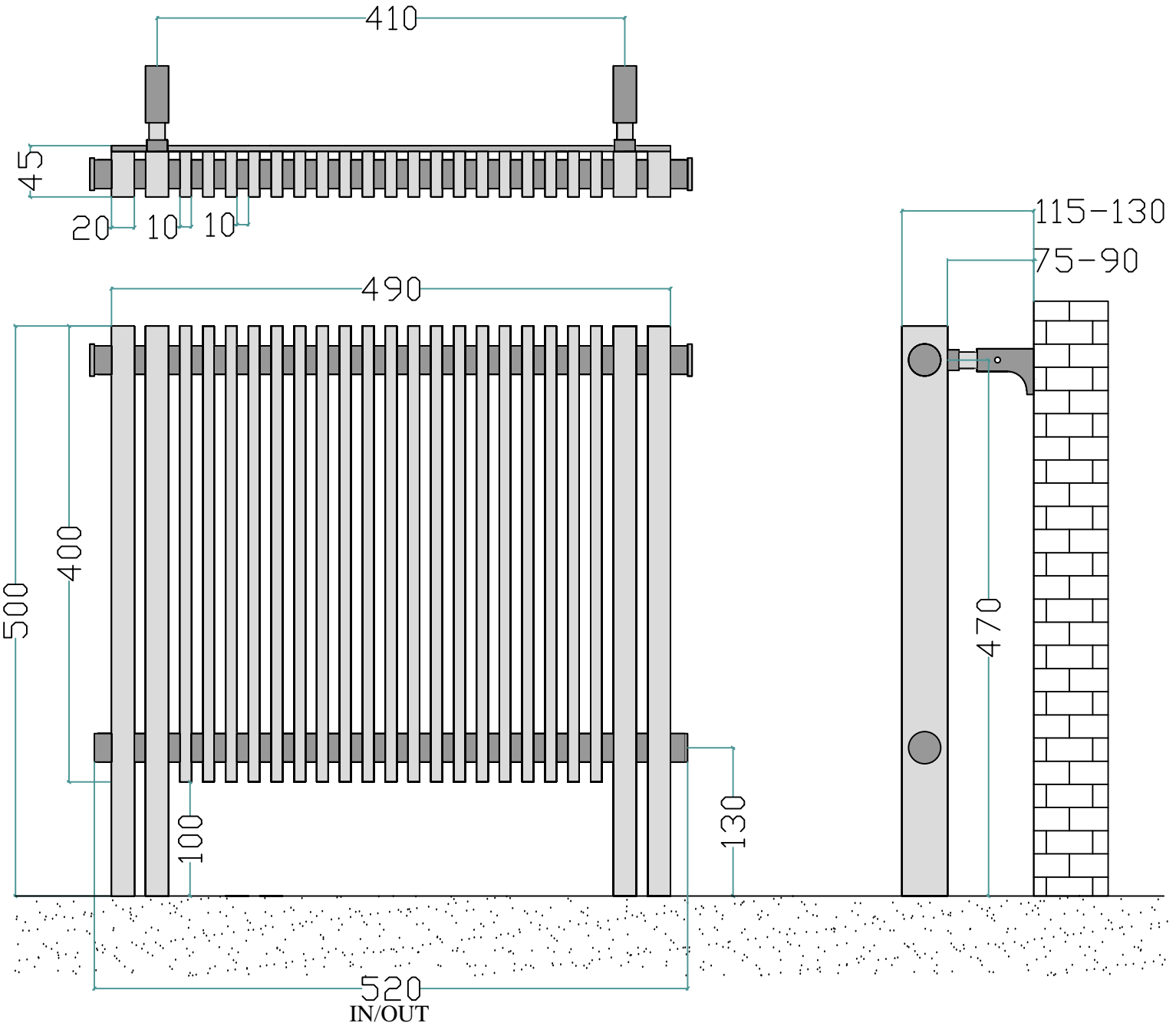

KORLE	Watt	BTU	Watt	BTU
	Δ 50°C	Δ 50°C	Δ 60°C	Δ 60°C
Cadence 50M23	570	1945	721	2459

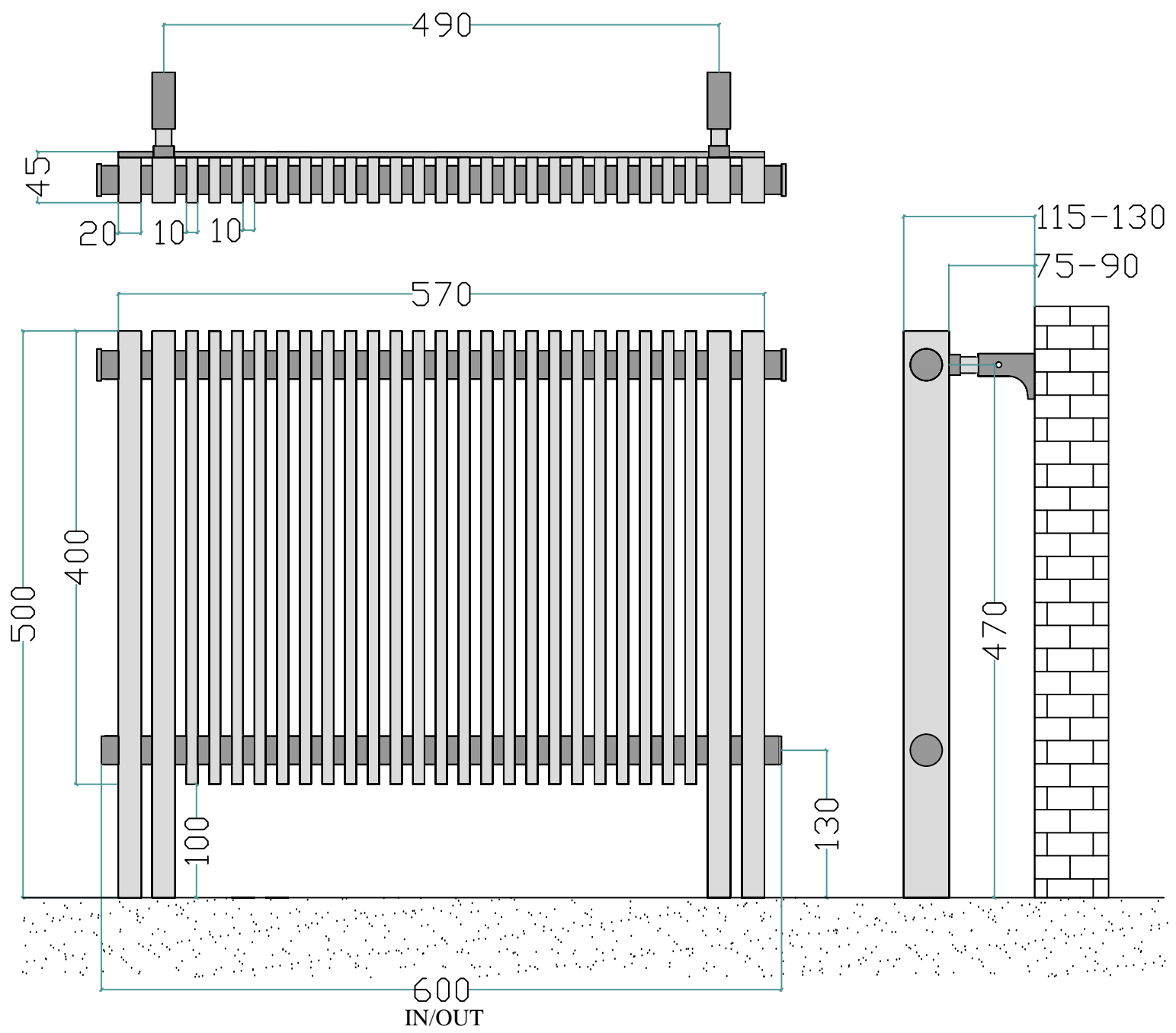

KORLE	Watt	BTU	Watt	BTU
	Δ 50°C	Δ 50°C	Δ 60°C	Δ 60°C
Cadence 50M27	661	2256	836	2853

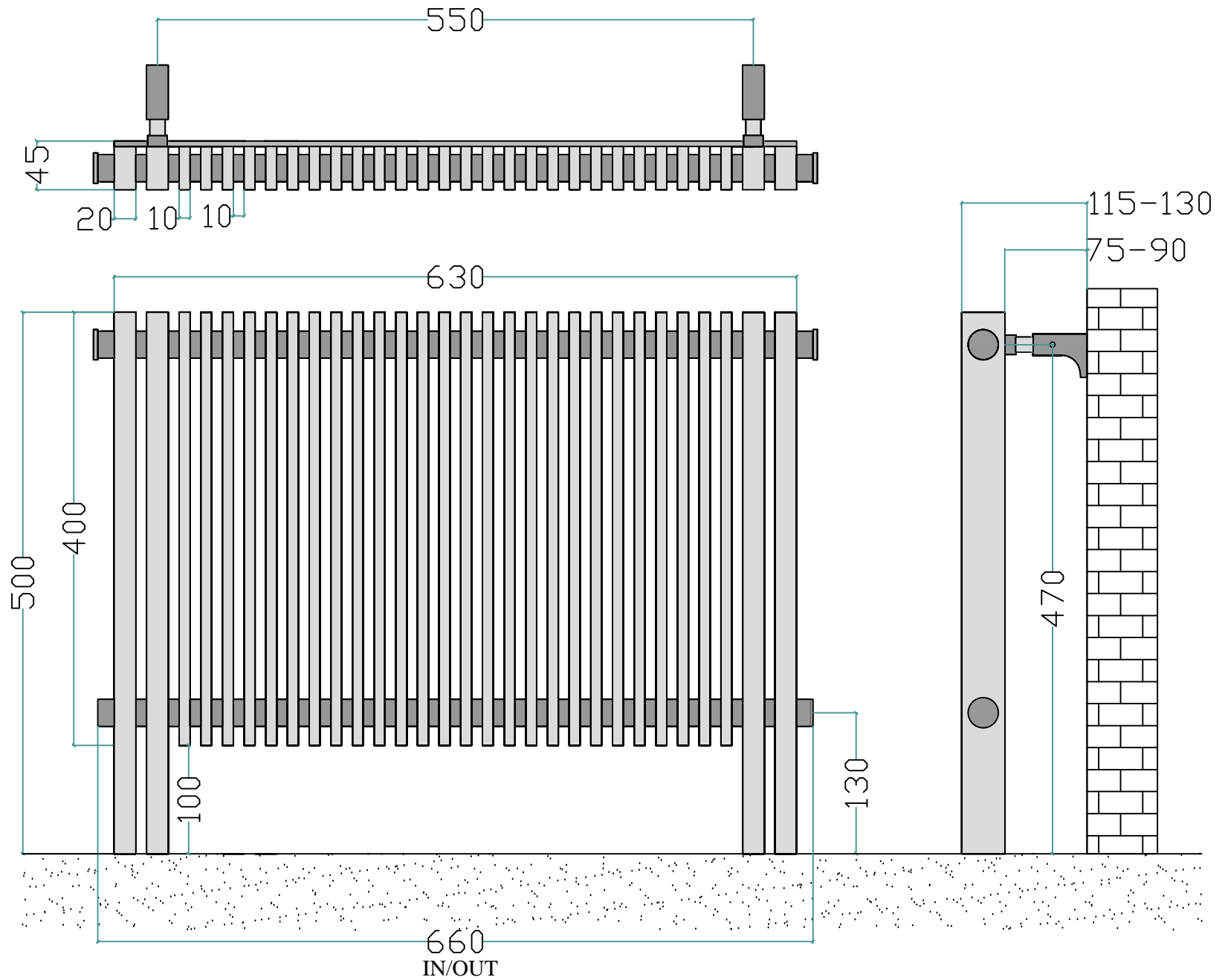

KORLE	Watt	BTU	Watt	BTU
	Δ 50°C	Δ 50°C	Δ 60°C	Δ 60°C
Cadence 50M30	730	2490	923	3148

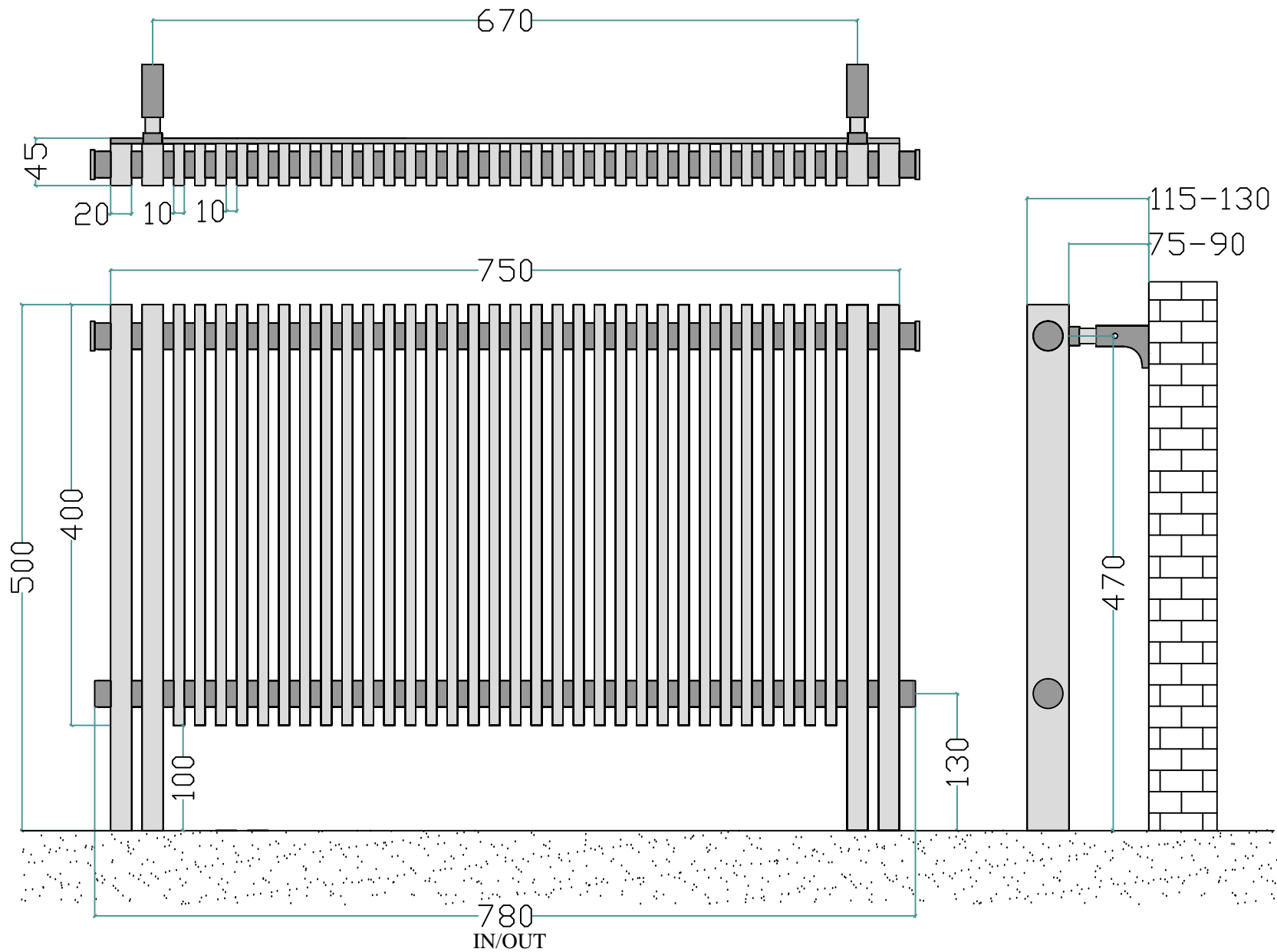

KORLE	Watt	BTU	Watt	BTU
	$\Delta 50^{\circ}\text{C}$	$\Delta 50^{\circ}\text{C}$	$\Delta 60^{\circ}\text{C}$	$\Delta 60^{\circ}\text{C}$
Cadence 50M36	866	2956	1096	3738

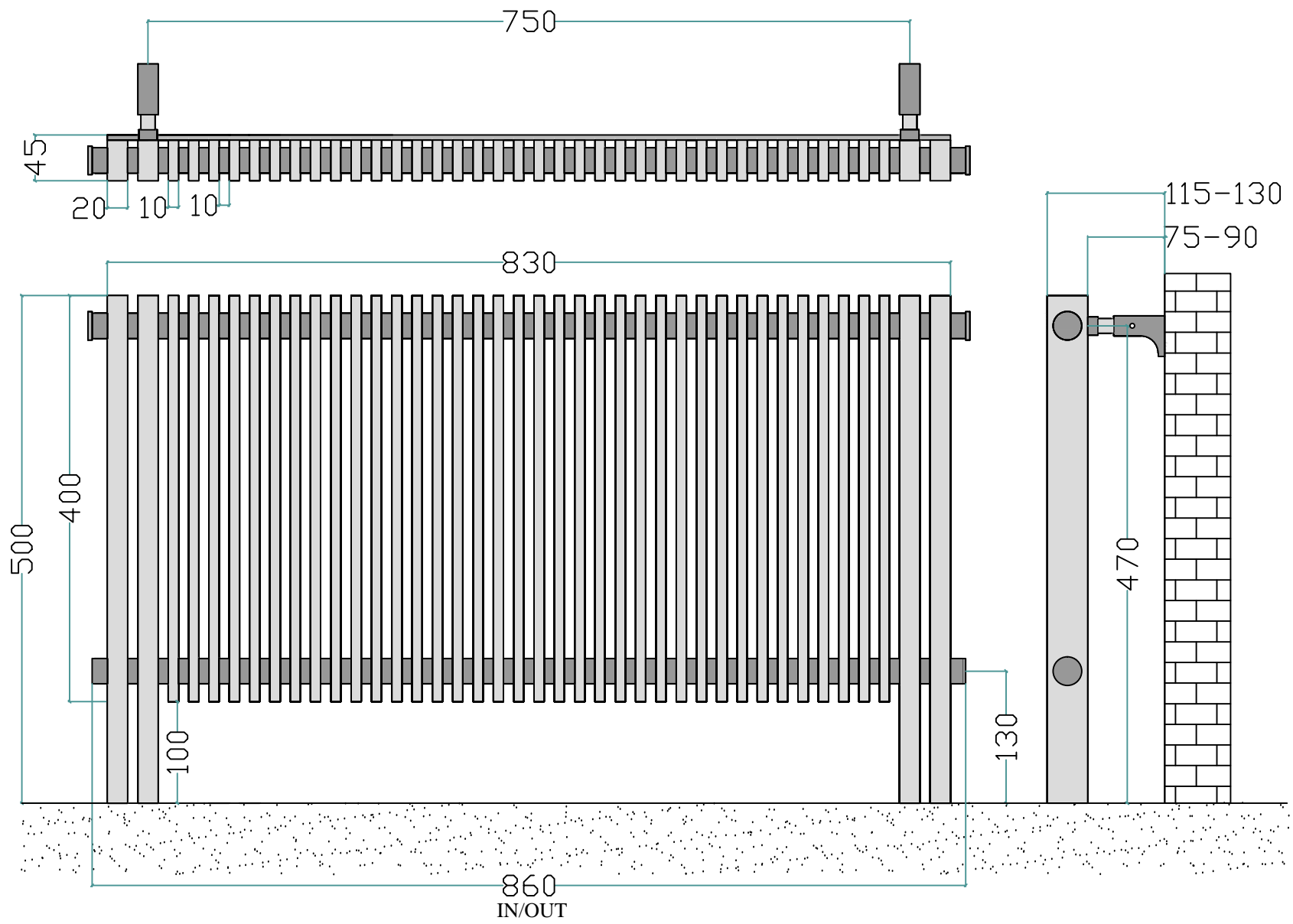

KORLE	Watt	BTU	Watt	BTU
	$\Delta 50^{\circ}\text{C}$	$\Delta 50^{\circ}\text{C}$	$\Delta 60^{\circ}\text{C}$	$\Delta 60^{\circ}\text{C}$
Cadence 50M40	958	3268	1211	4132

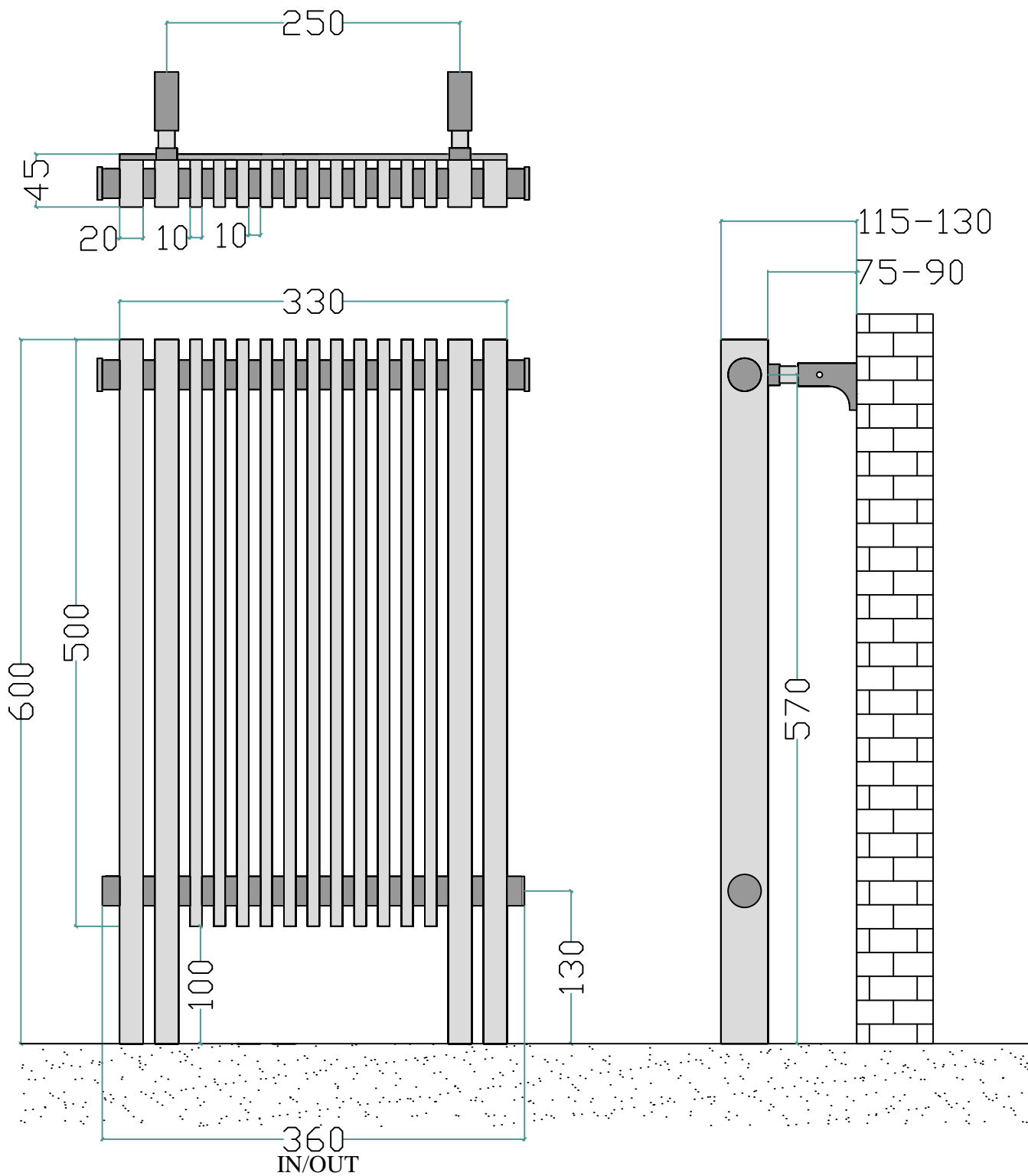

KORLE	Watt	BTU	Watt	BTU
	$\Delta 50^{\circ}\text{C}$	$\Delta 50^{\circ}\text{C}$	$\Delta 60^{\circ}\text{C}$	$\Delta 60^{\circ}\text{C}$
Cadence 60M15	478	1630	604	2061

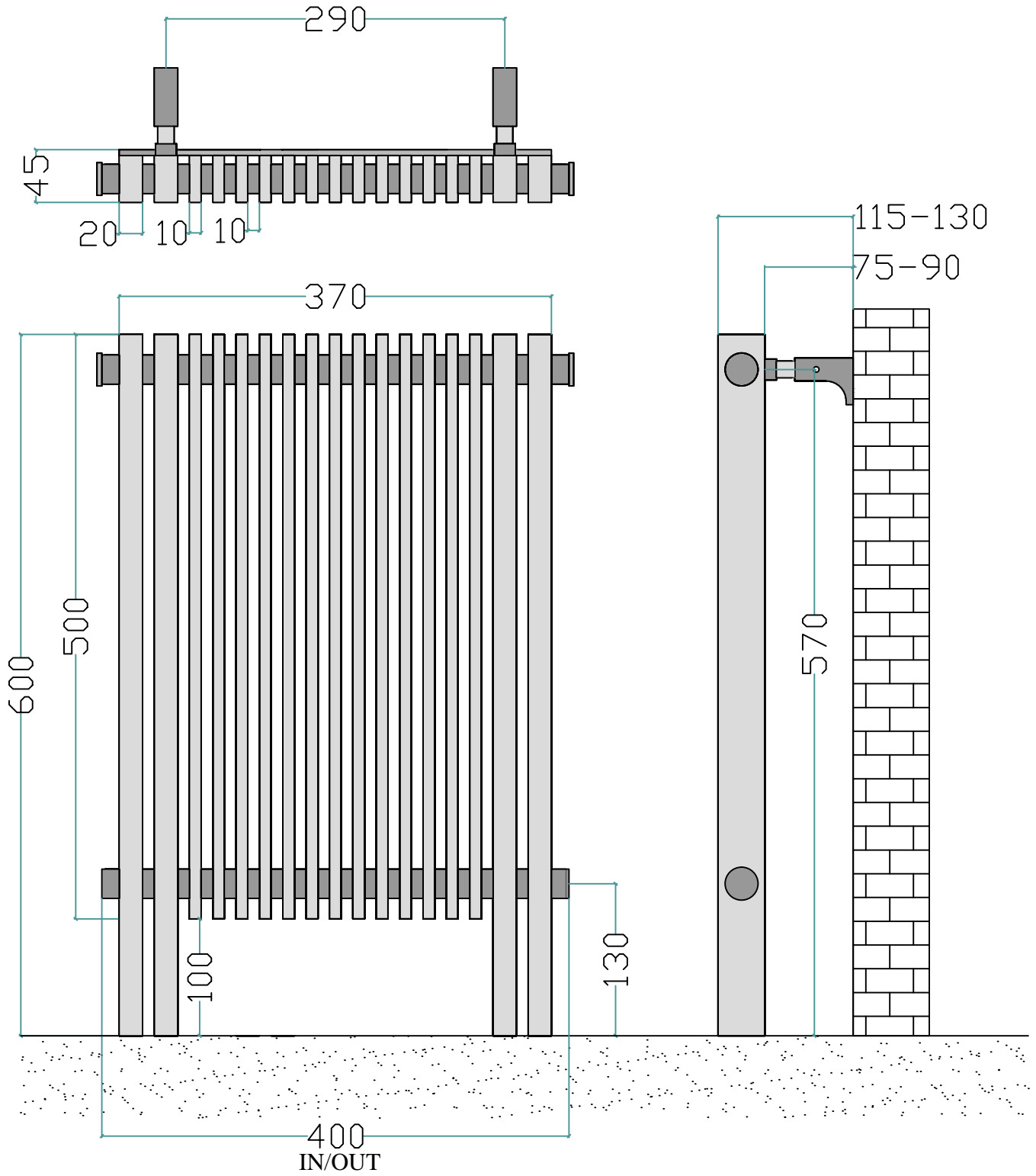

KORLE	Watt	BTU	Watt	BTU
	$\Delta 50^{\circ}\text{C}$	$\Delta 50^{\circ}\text{C}$	$\Delta 60^{\circ}\text{C}$	$\Delta 60^{\circ}\text{C}$
Cadence 60M17	535	1824	676	2307

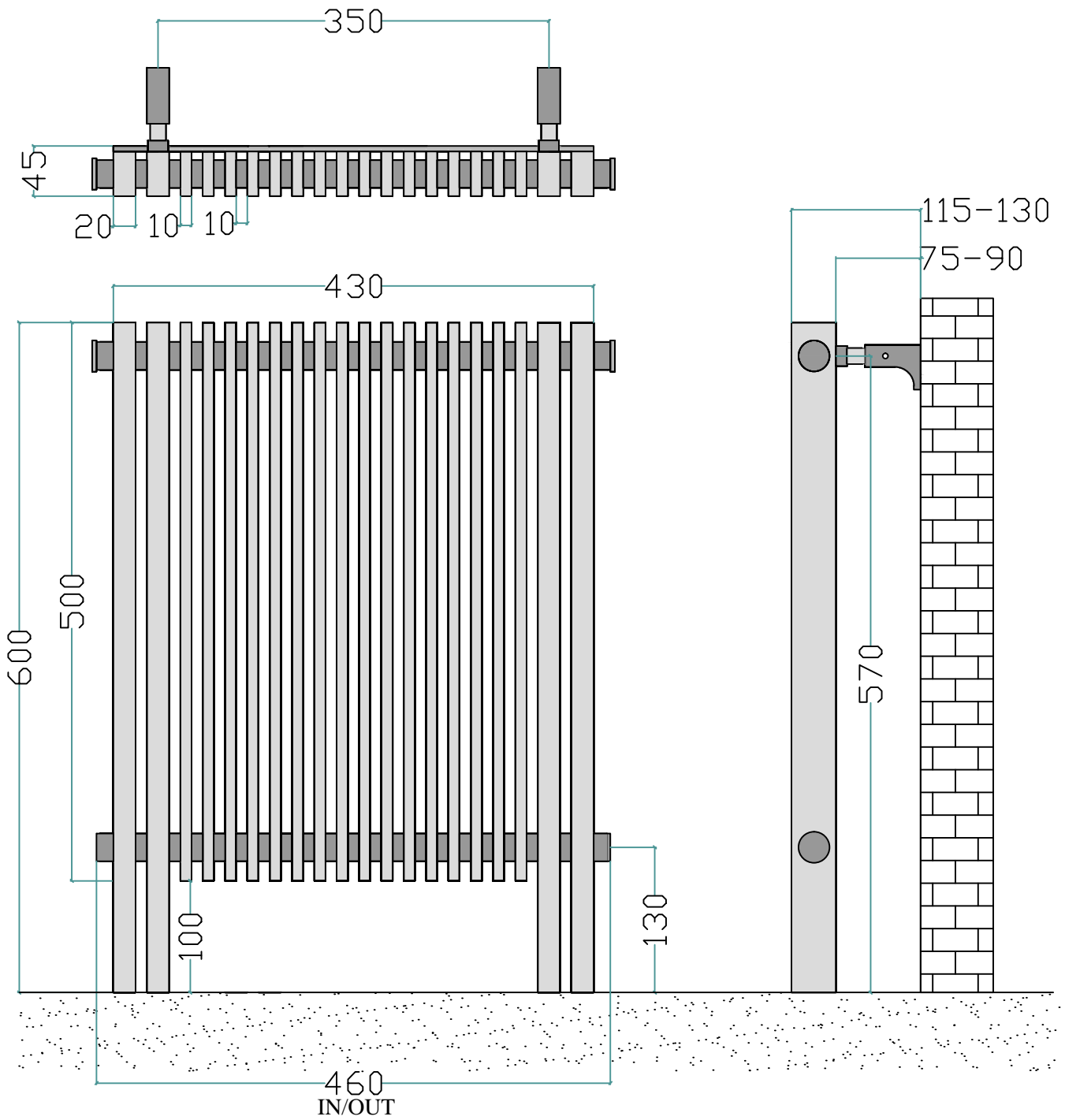

KORLE	Watt	BTU	Watt	BTU
	$\Delta 50^{\circ}\text{C}$	$\Delta 50^{\circ}\text{C}$	$\Delta 60^{\circ}\text{C}$	$\Delta 60^{\circ}\text{C}$
Cadence 60M20	620	2116	784	2676

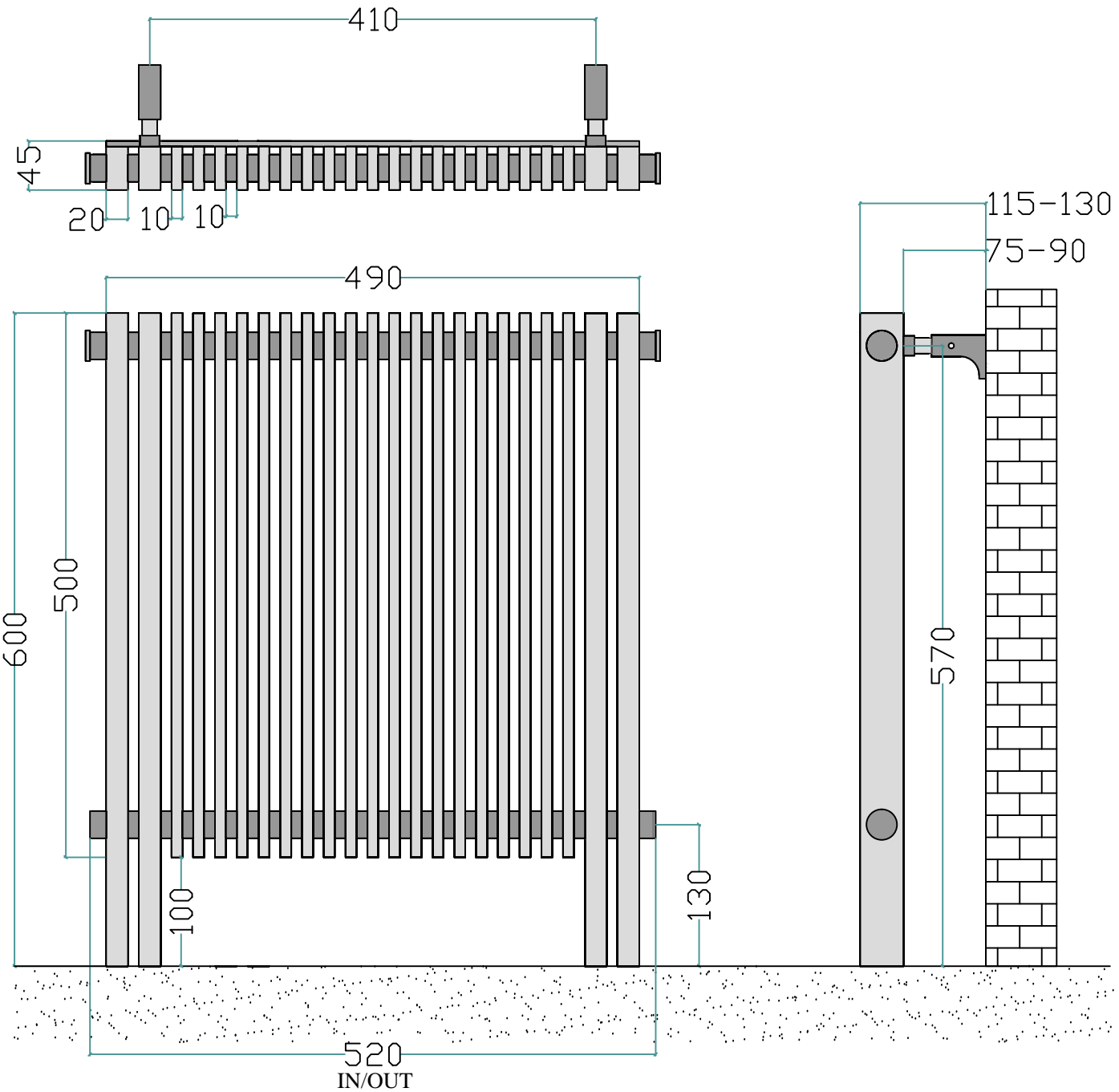

KORLE	Watt	BTU	Watt	BTU
	$\Delta 50^{\circ}\text{C}$	$\Delta 50^{\circ}\text{C}$	$\Delta 60^{\circ}\text{C}$	$\Delta 60^{\circ}\text{C}$
Cadence 60M23	706	2408	892	3045

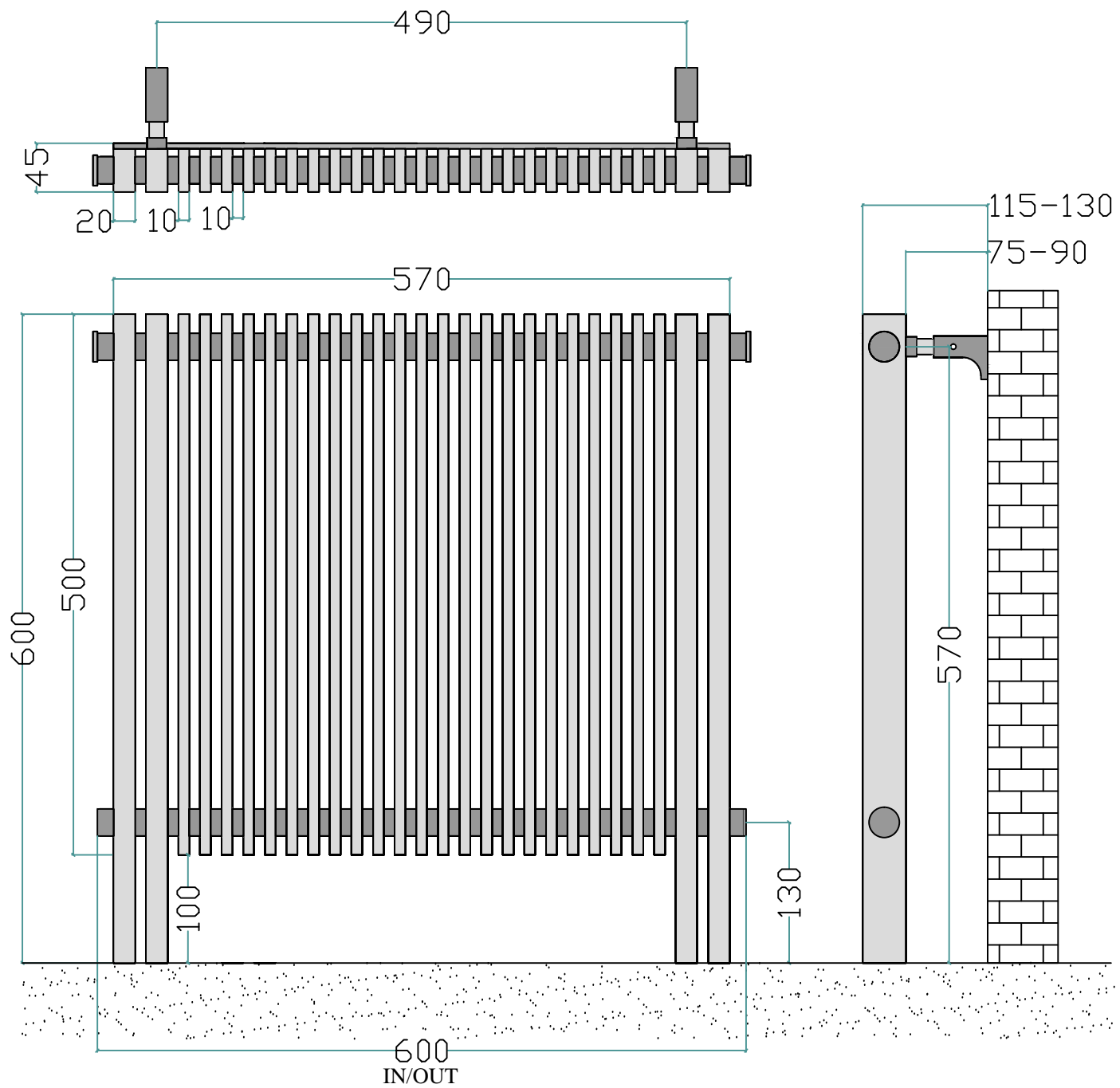

KORLE	Watt	BTU	Watt	BTU
	$\Delta 50^{\circ}\text{C}$	$\Delta 50^{\circ}\text{C}$	$\Delta 60^{\circ}\text{C}$	$\Delta 60^{\circ}\text{C}$
Cadence 60M27	820	2797	1036	3537

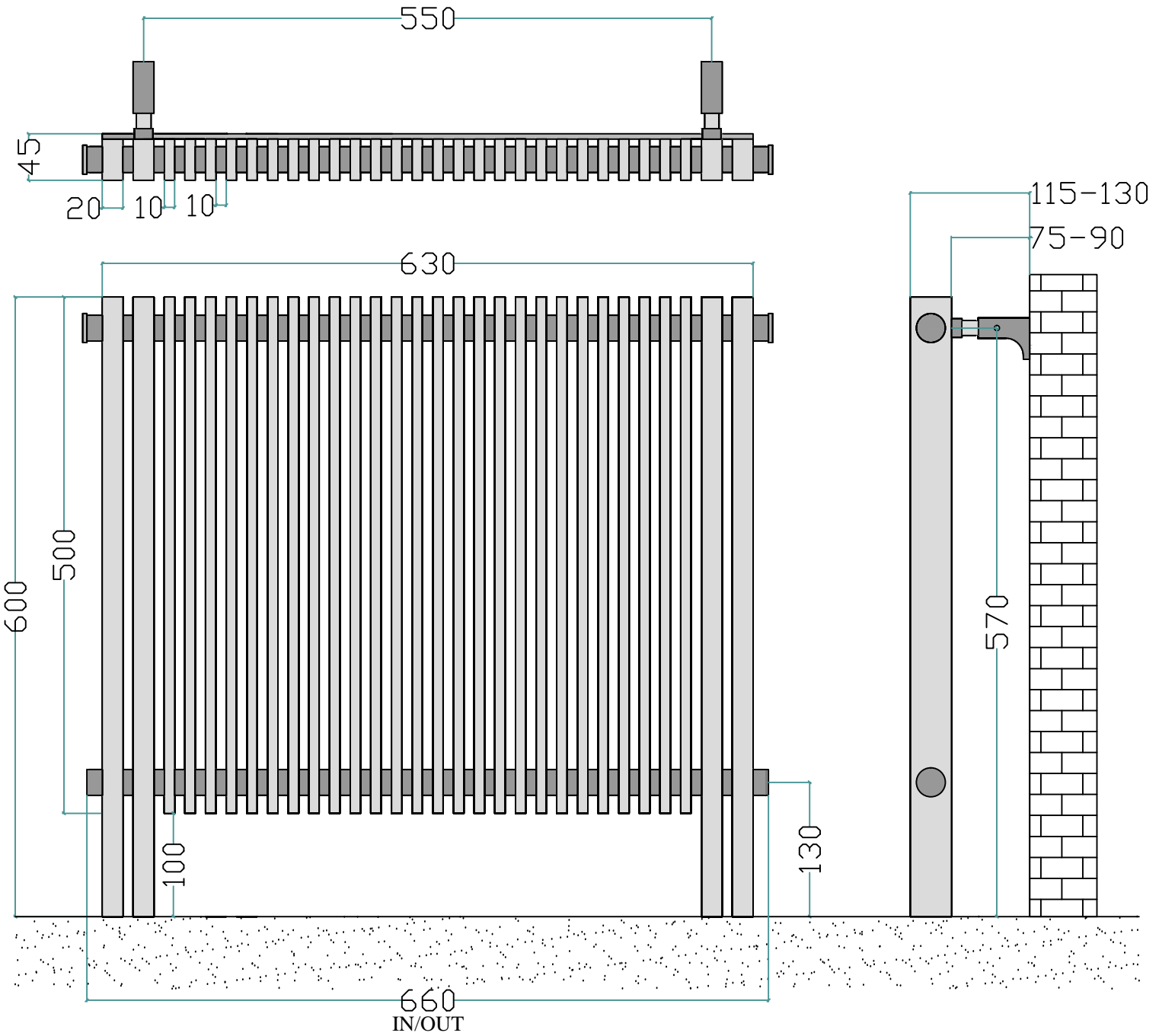

KORLE	Watt	BTU	Watt	BTU
	$\Delta 50^{\circ}\text{C}$	$\Delta 50^{\circ}\text{C}$	$\Delta 60^{\circ}\text{C}$	$\Delta 60^{\circ}\text{C}$
Cadence 60M30	905	3089	1145	3906

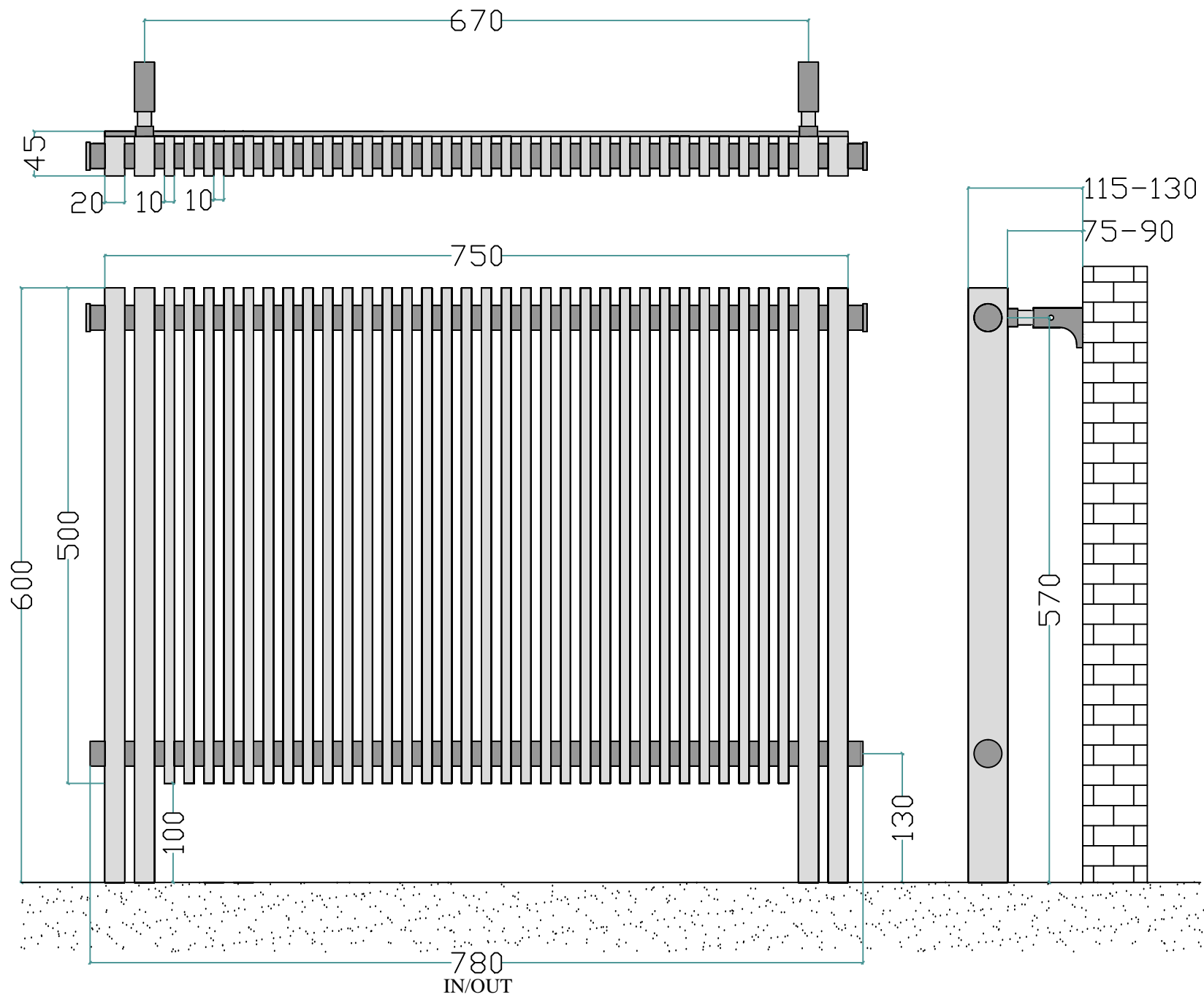

KORLE	Watt	BTU	Watt	BTU
	Δ 50°C	Δ 50°C	Δ 60°C	Δ 60°C
Cadence 60M36	1076	3672	1361	4643

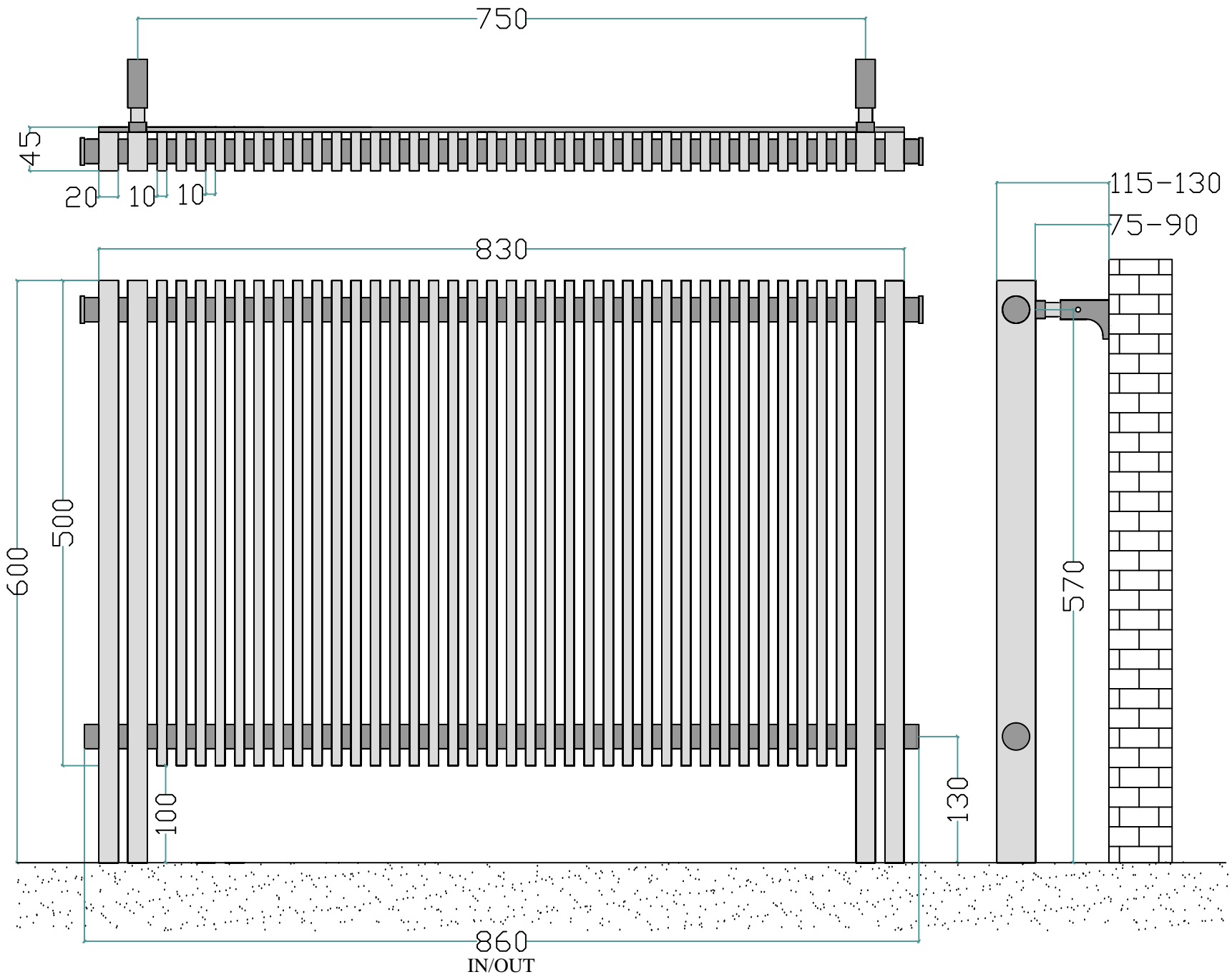

KORLE	Watt	BTU	Watt	BTU
	Δ 50°C	Δ 50°C	Δ 60°C	Δ 60°C
Cadence 60M40	1190	4061	1505	5135

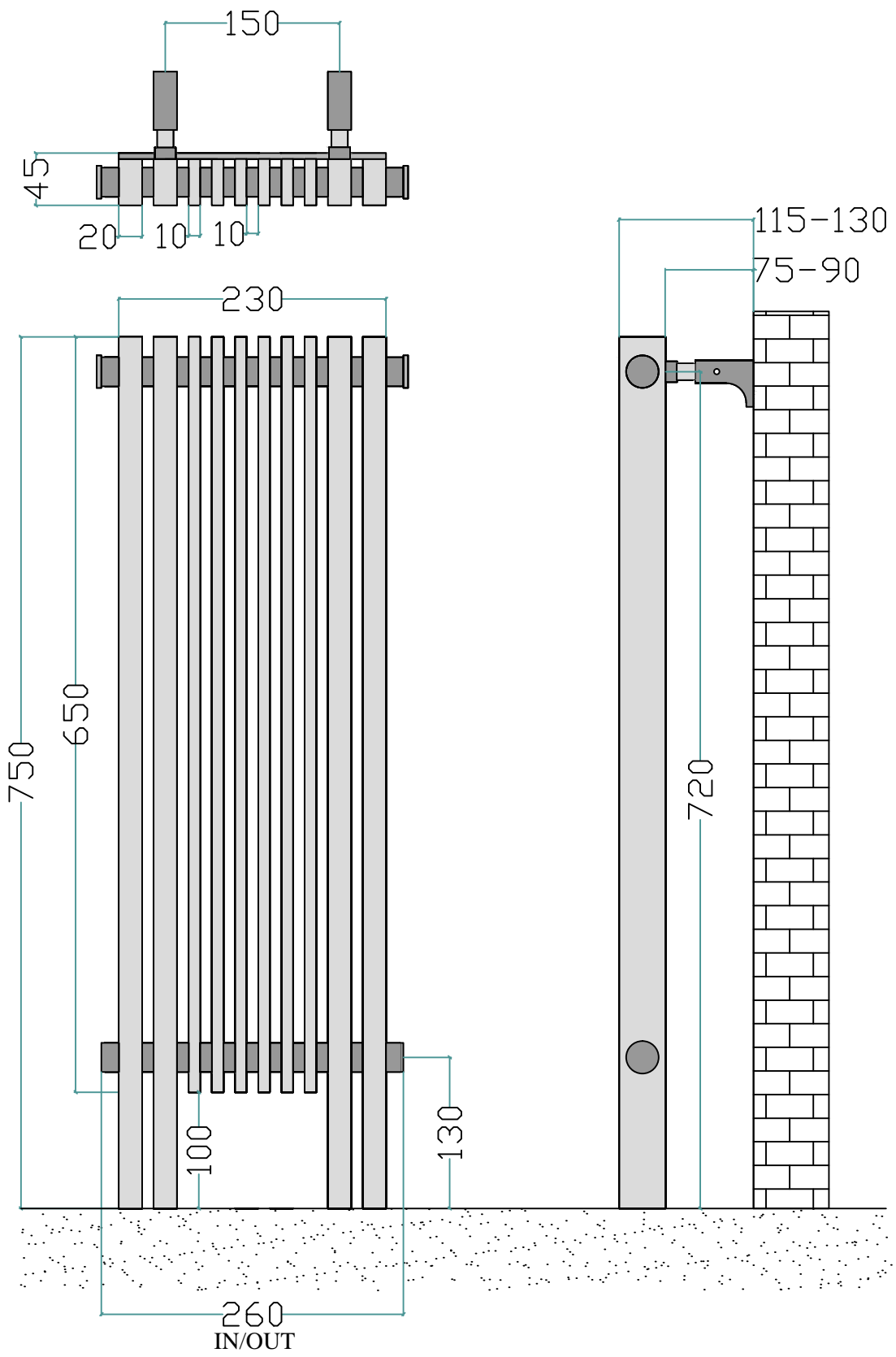

KORLE	Watt	BTU	Watt	BTU
	$\Delta 50^{\circ}\text{C}$	$\Delta 50^{\circ}\text{C}$	$\Delta 60^{\circ}\text{C}$	$\Delta 60^{\circ}\text{C}$
Cadence 75M10	428	1459	541	1845

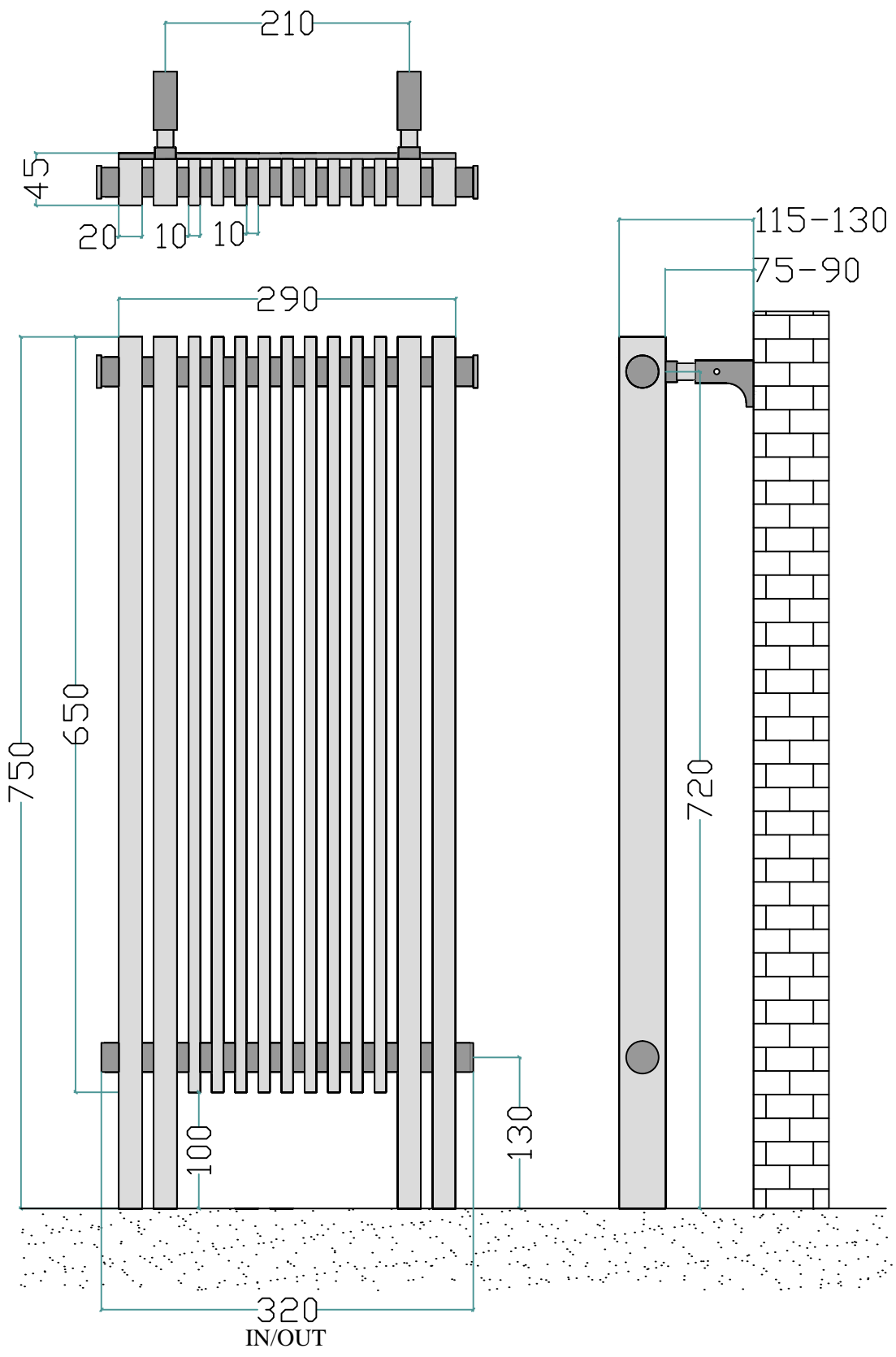

KORLE	Watt	BTU	Watt	BTU
	$\Delta 50^{\circ}\text{C}$	$\Delta 50^{\circ}\text{C}$	$\Delta 60^{\circ}\text{C}$	$\Delta 60^{\circ}\text{C}$
Cadence 75M13	539	1838	681	2324

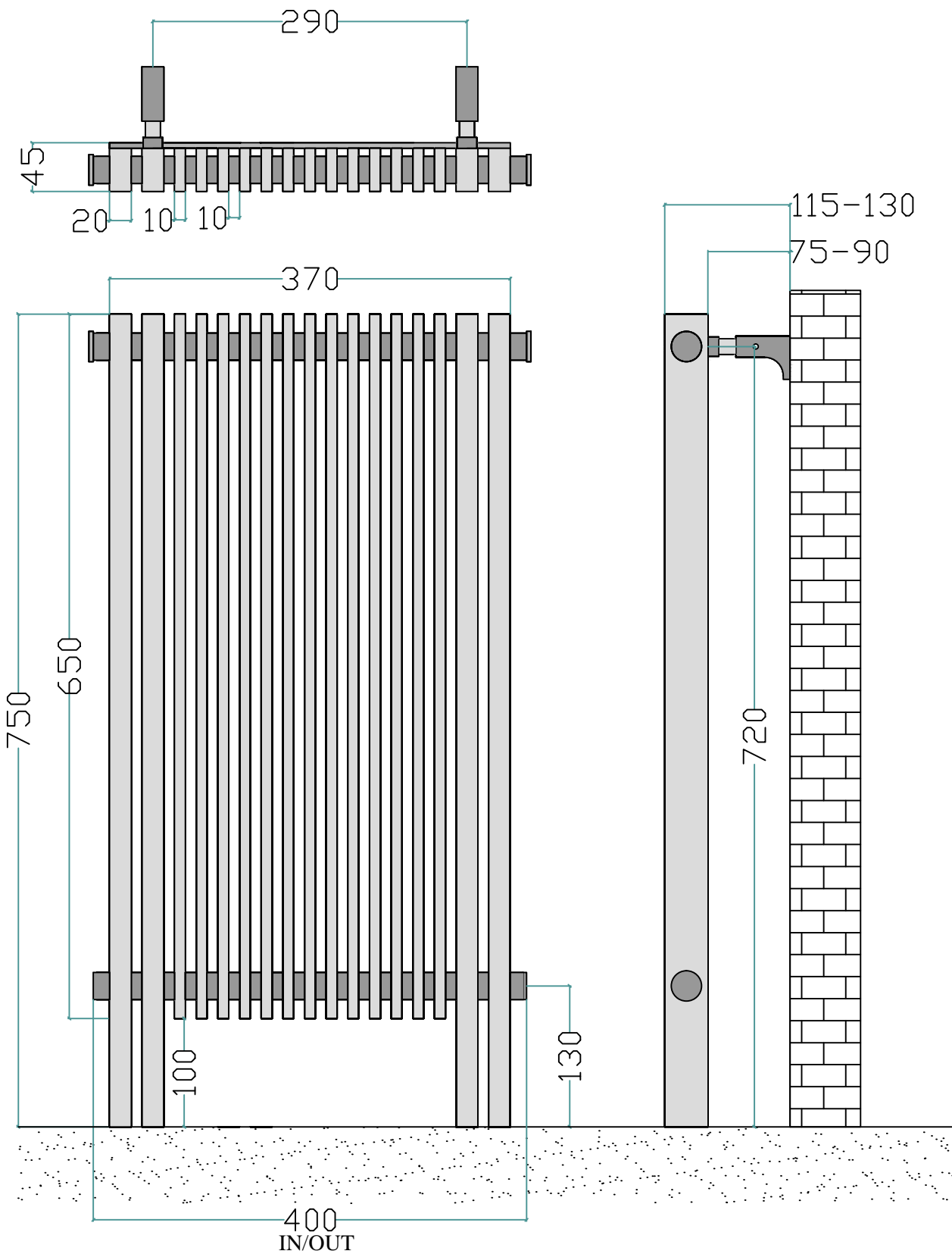

KORLE	Watt	BTU	Watt	BTU
	$\Delta 50^\circ\text{C}$	$\Delta 50^\circ\text{C}$	$\Delta 60^\circ\text{C}$	$\Delta 60^\circ\text{C}$
Cadence 75M17	687	2344	869	2964

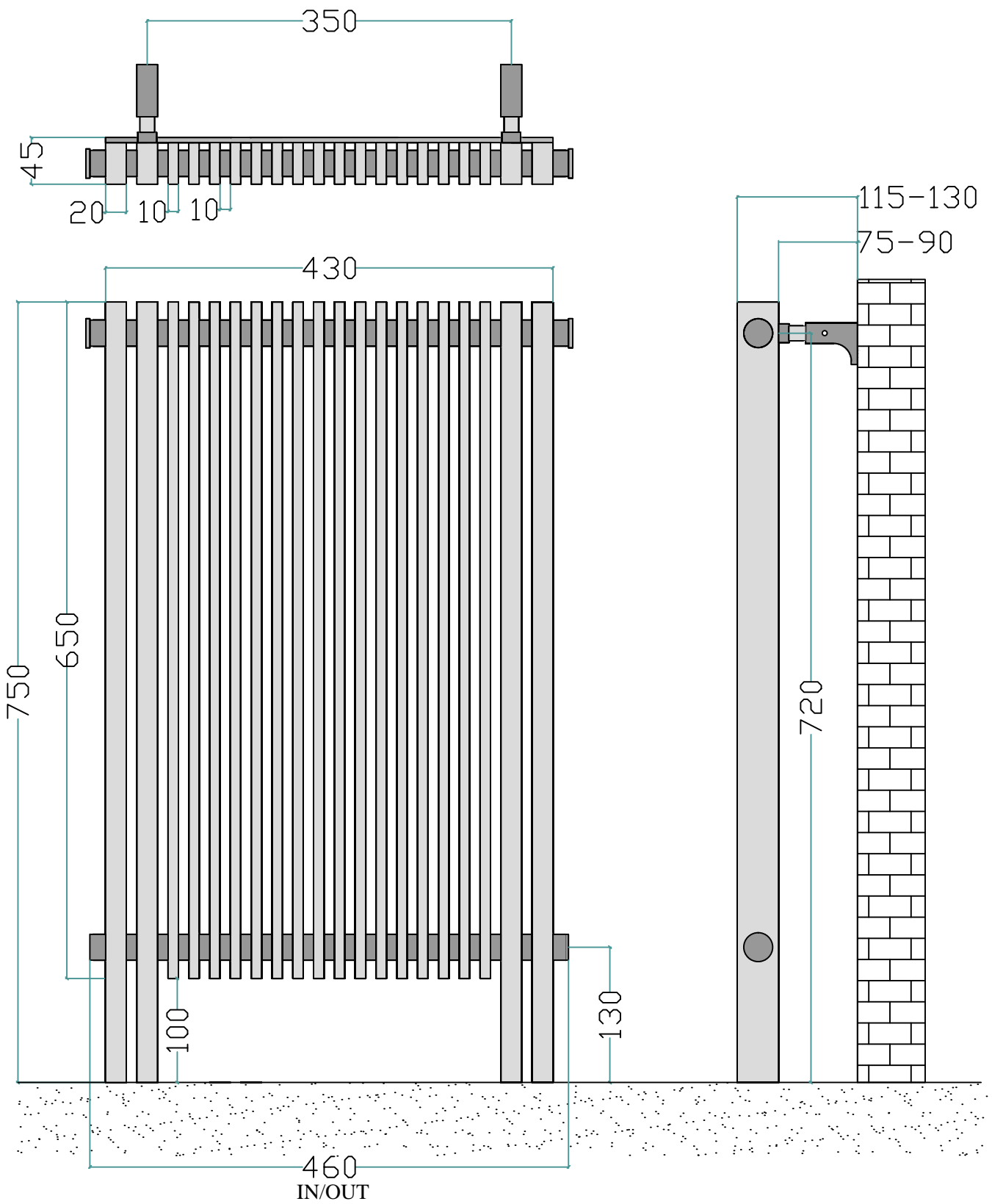

KORLE	Watt	BTU	Watt	BTU
	$\Delta 50^{\circ}\text{C}$	$\Delta 50^{\circ}\text{C}$	$\Delta 60^{\circ}\text{C}$	$\Delta 60^{\circ}\text{C}$
Cadence 75M20	798	2723	1009	3443

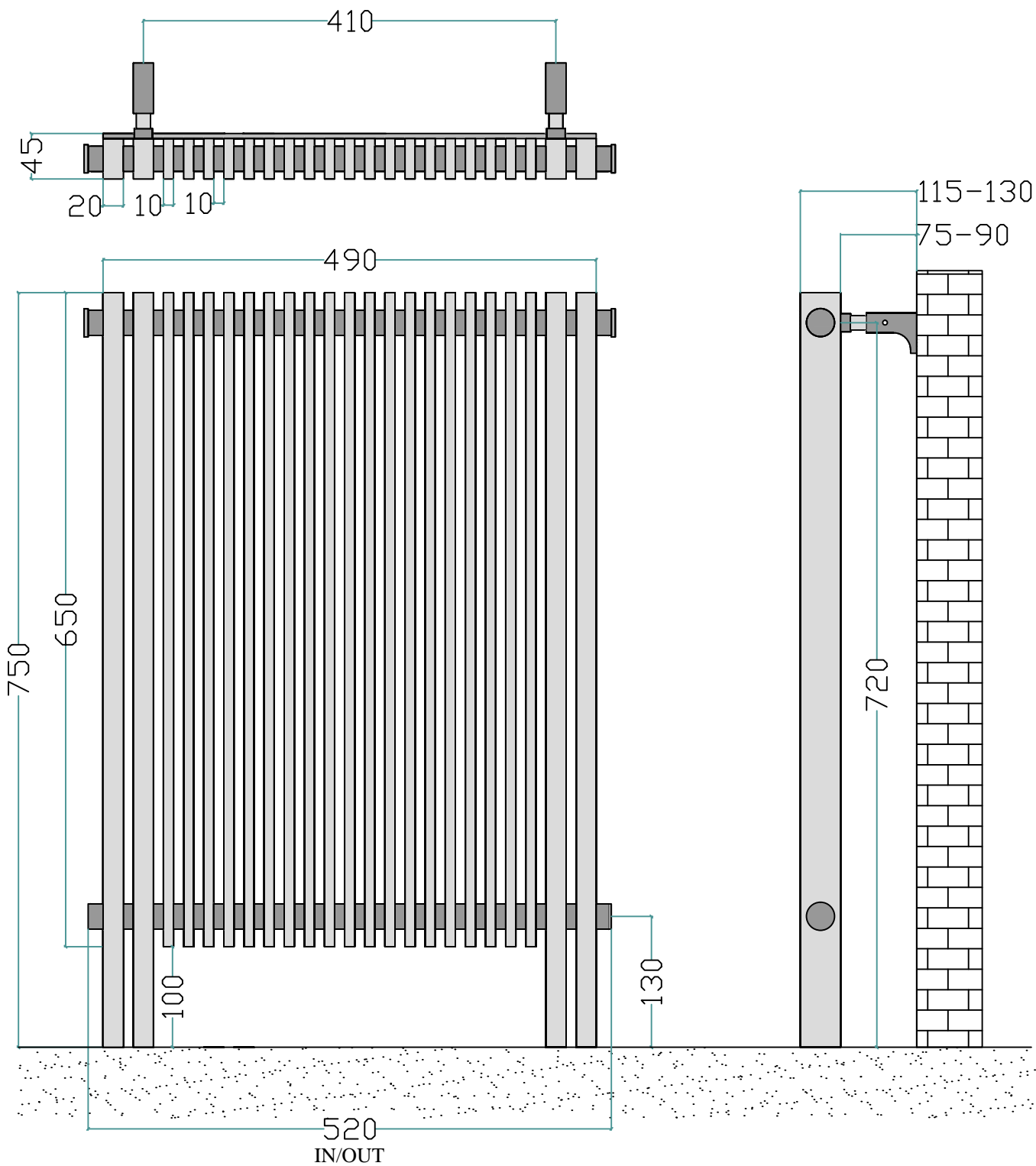

KORLE	Watt	BTU	Watt	BTU
	Δ 50°C	Δ 50°C	Δ 60°C	Δ 60°C
Cadence 75M23	909	3102	1150	3923

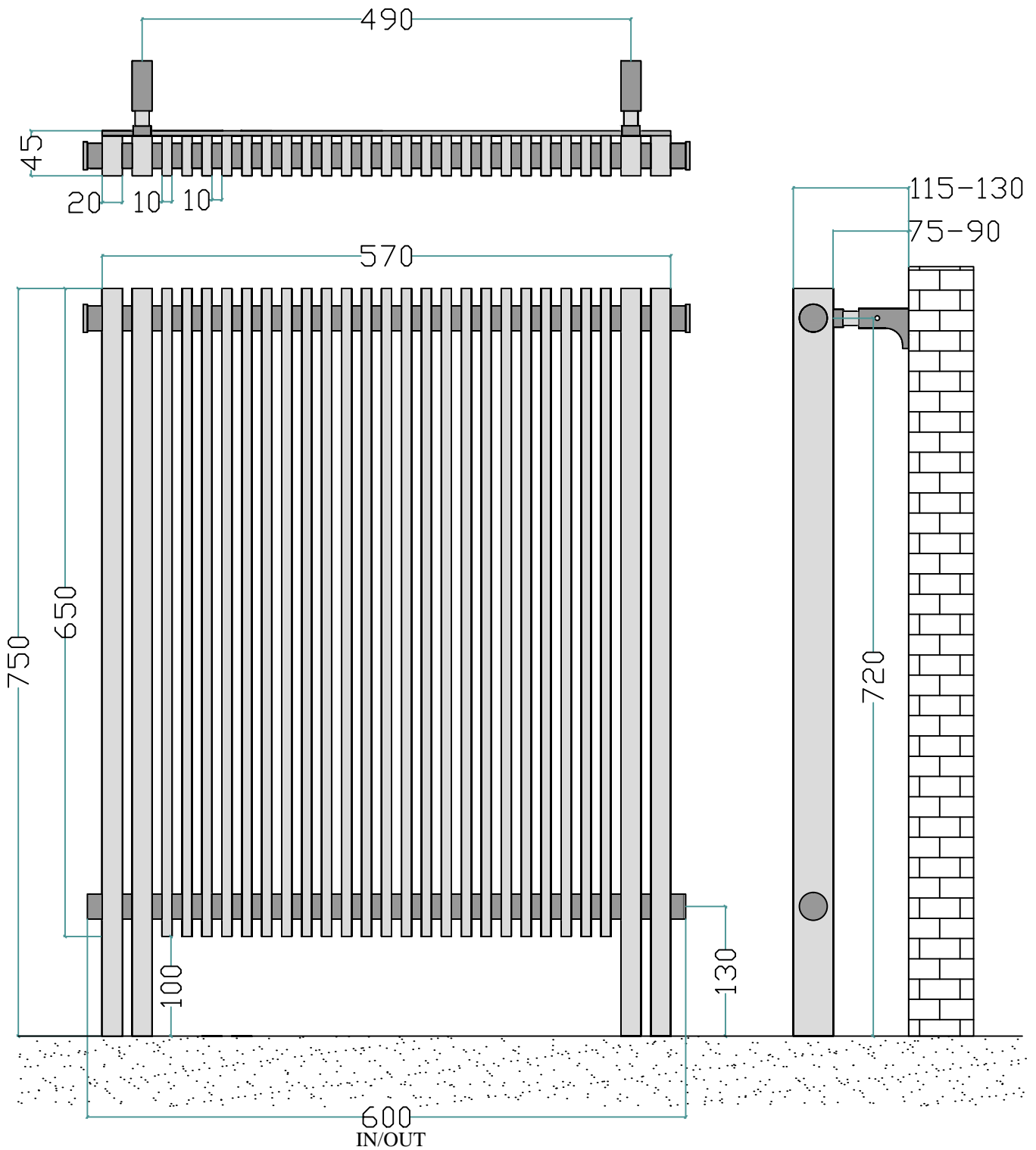

KORLE	Watt	BTU	Watt	BTU
	Δ 50°C	Δ 50°C	Δ 60°C	Δ 60°C
Cadence 75M27	1057	3608	1337	4562

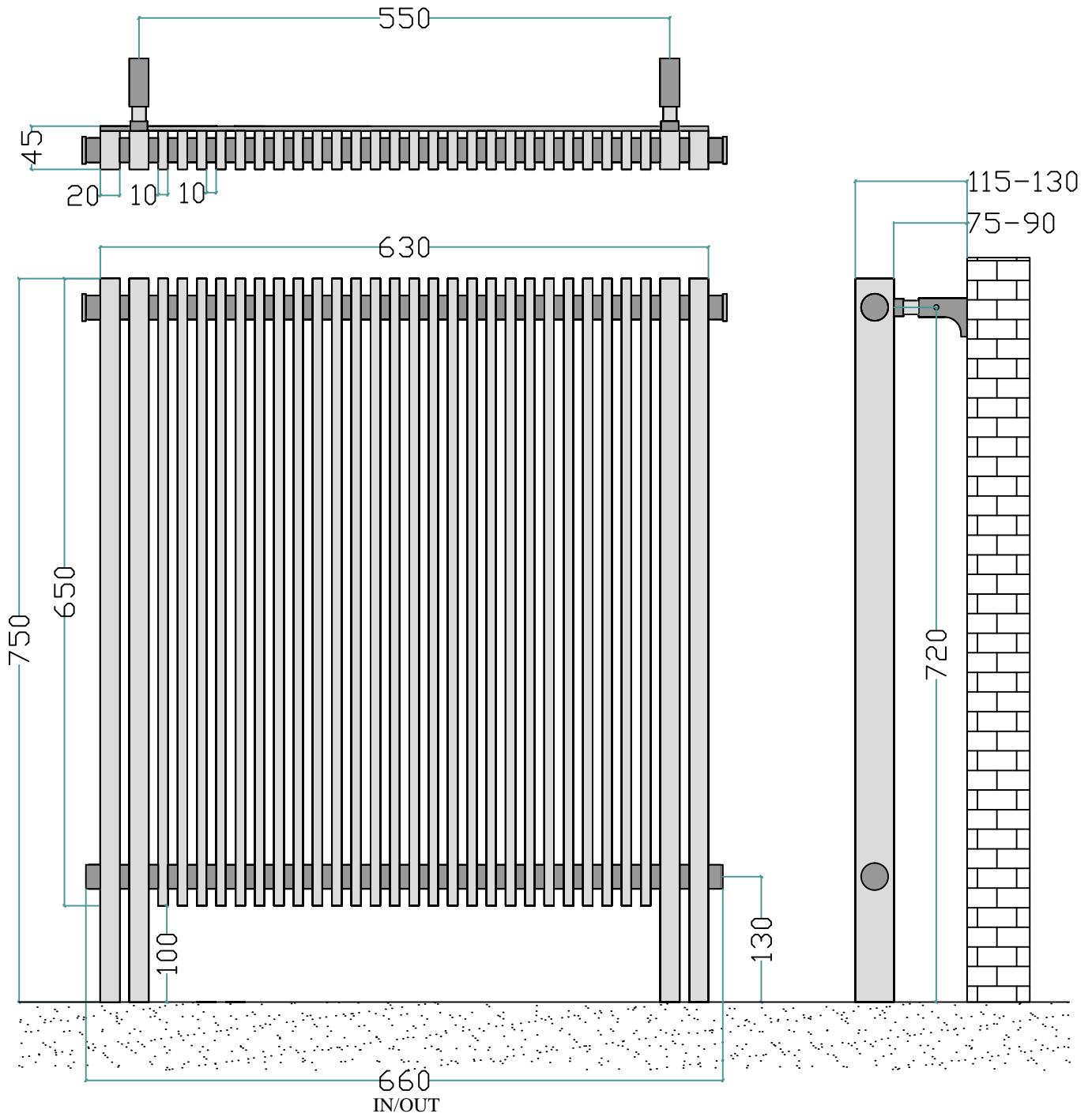

KORLE	Watt	BTU	Watt	BTU
	$\Delta 50^{\circ}\text{C}$	$\Delta 50^{\circ}\text{C}$	$\Delta 60^{\circ}\text{C}$	$\Delta 60^{\circ}\text{C}$
Cadence 75M30	1169	3987	1478	5042

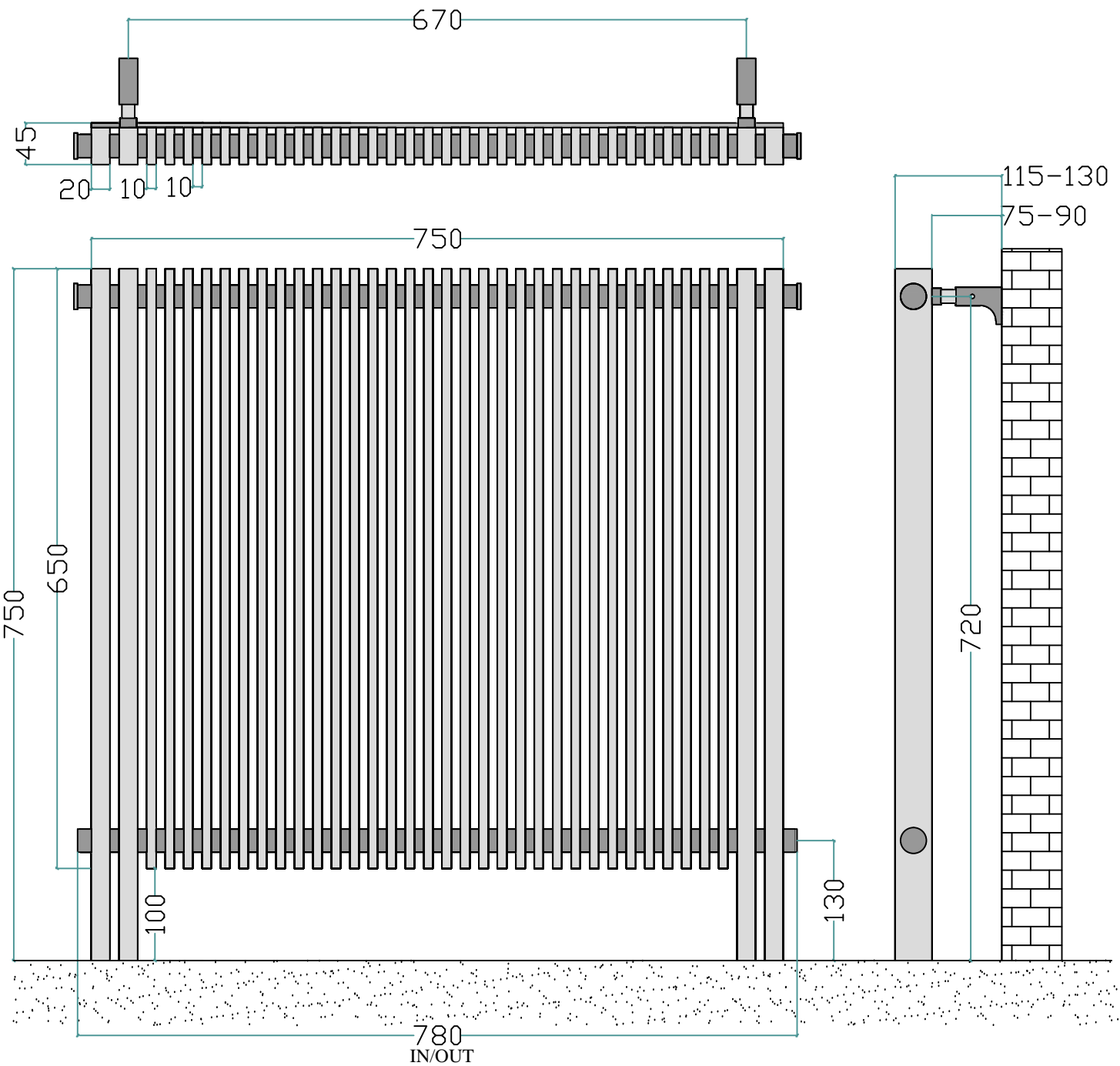

KORLE	Watt	BTU	Watt	BTU
	$\Delta 50^{\circ}\text{C}$	$\Delta 50^{\circ}\text{C}$	$\Delta 60^{\circ}\text{C}$	$\Delta 60^{\circ}\text{C}$
Cadence 75M36	1391	4746	1759	6001

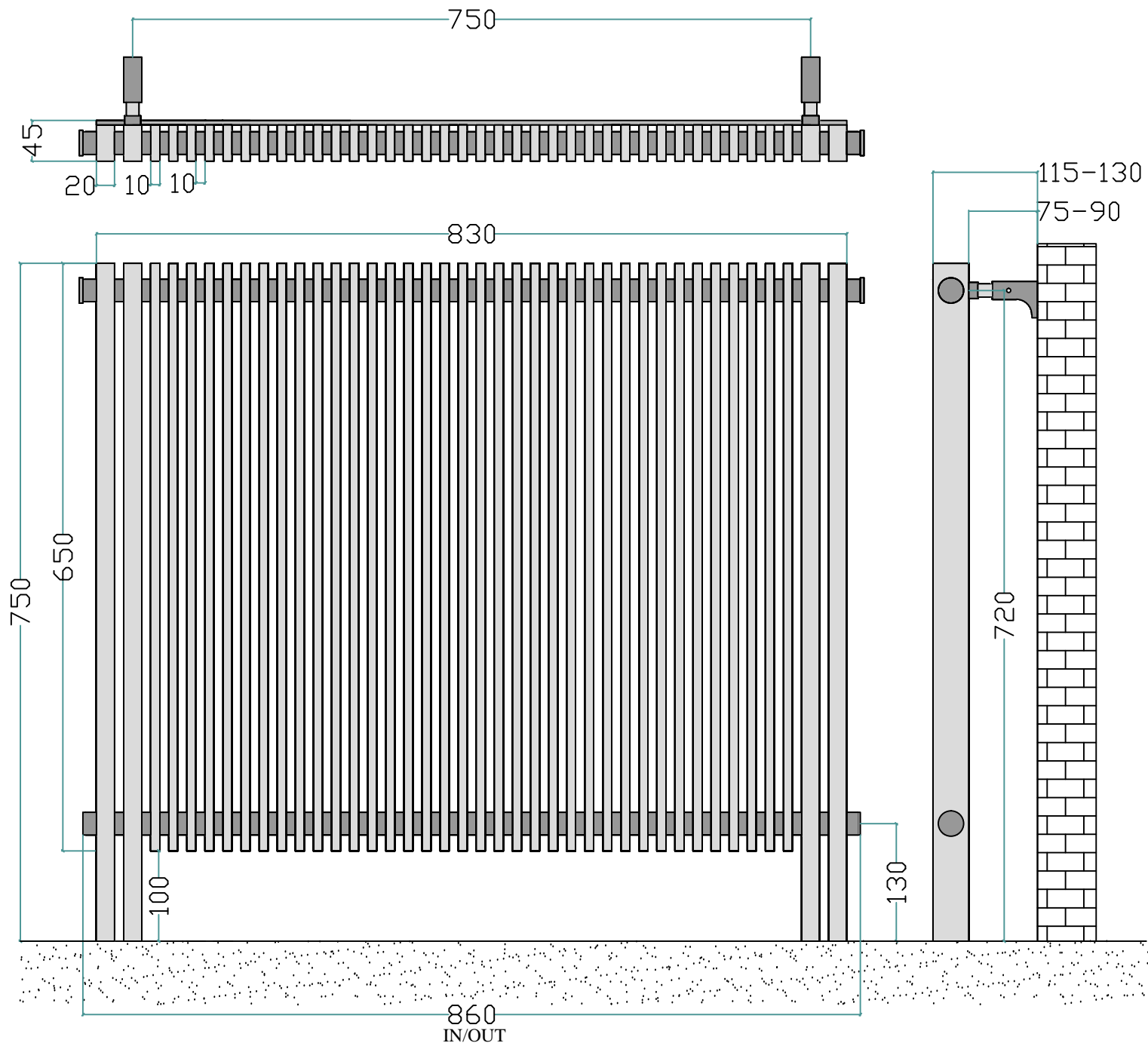

KORLE	Watt	BTU	Watt	BTU
	$\Delta 50^{\circ}\text{C}$	$\Delta 50^{\circ}\text{C}$	$\Delta 60^{\circ}\text{C}$	$\Delta 60^{\circ}\text{C}$
Cadence 75M40	1539	5252	1946	6641

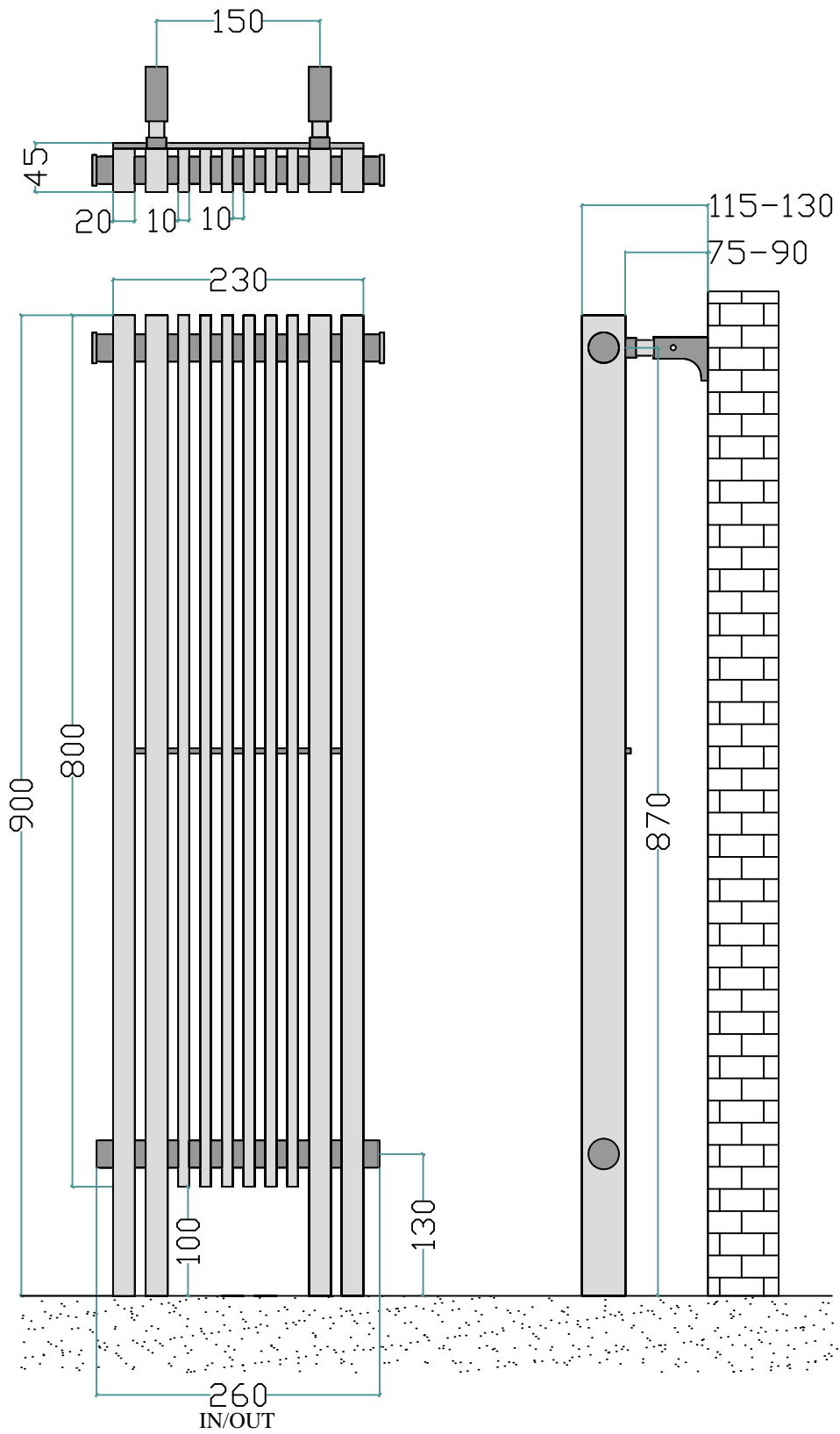

KORLE	Watt	BTU	Watt	BTU
	$\Delta 50^{\circ}\text{C}$	$\Delta 50^{\circ}\text{C}$	$\Delta 60^{\circ}\text{C}$	$\Delta 60^{\circ}\text{C}$
Cadence 90M10	520	1774	657	2243

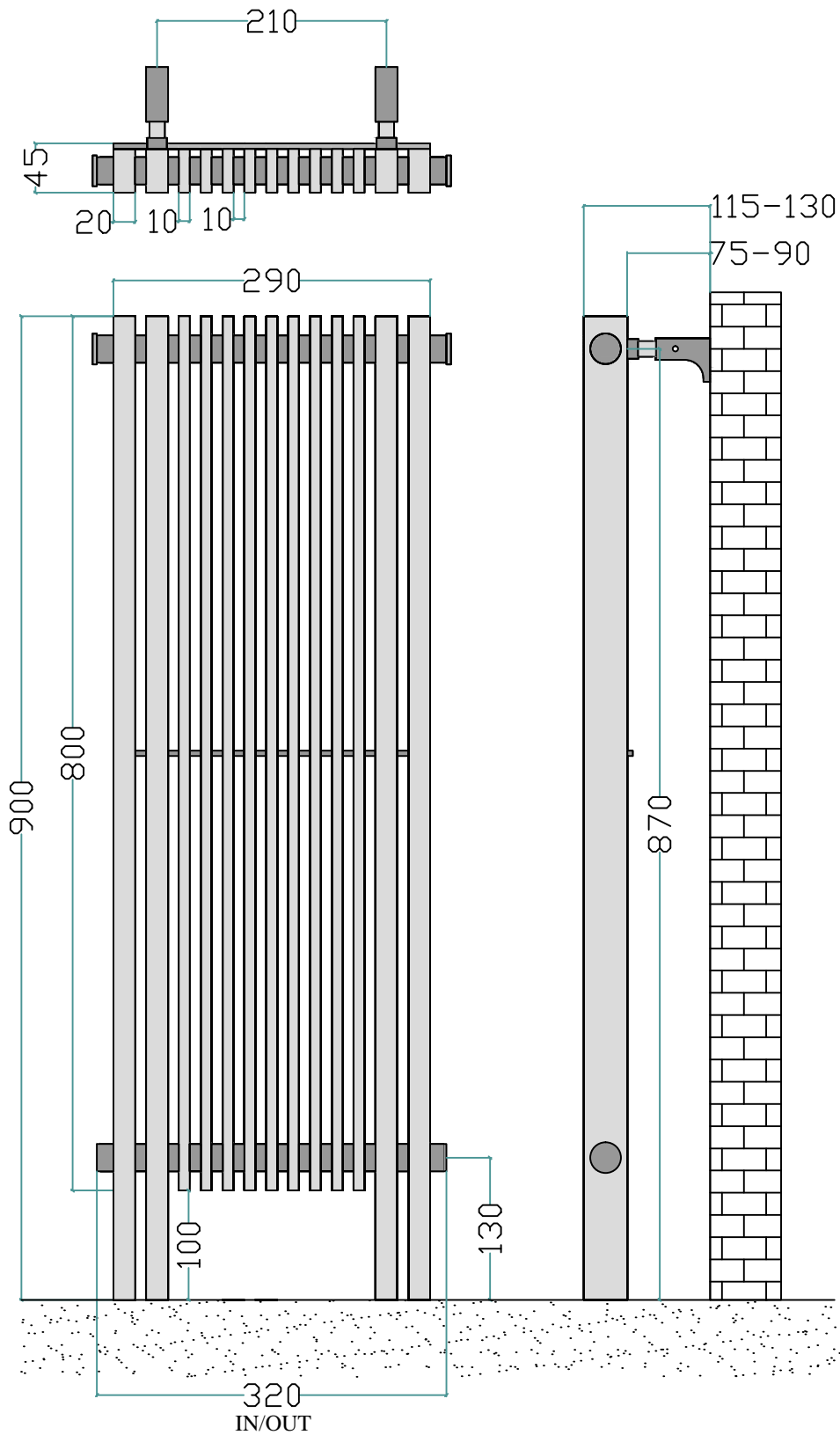

KORLE	Watt	BTU	Watt	BTU
	Δ 50°C	Δ 50°C	Δ 60°C	Δ 60°C
Cadence 90M13	657	2241	830	2833

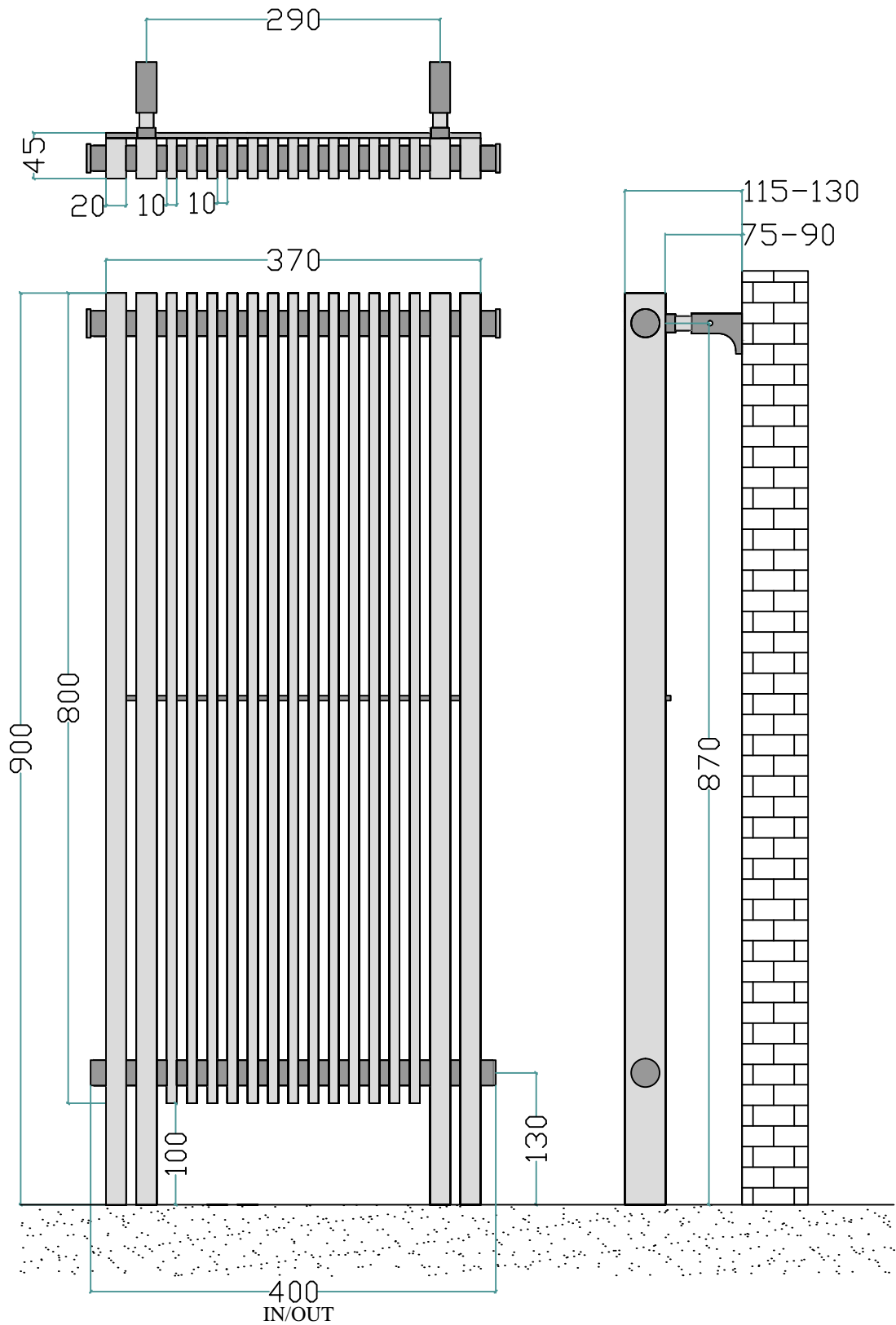

KORLE	Watt	BTU	Watt	BTU
	$\Delta 50^{\circ}\text{C}$	$\Delta 50^{\circ}\text{C}$	$\Delta 60^{\circ}\text{C}$	$\Delta 60^{\circ}\text{C}$
Cadence 90M17	839	2863	1061	3620

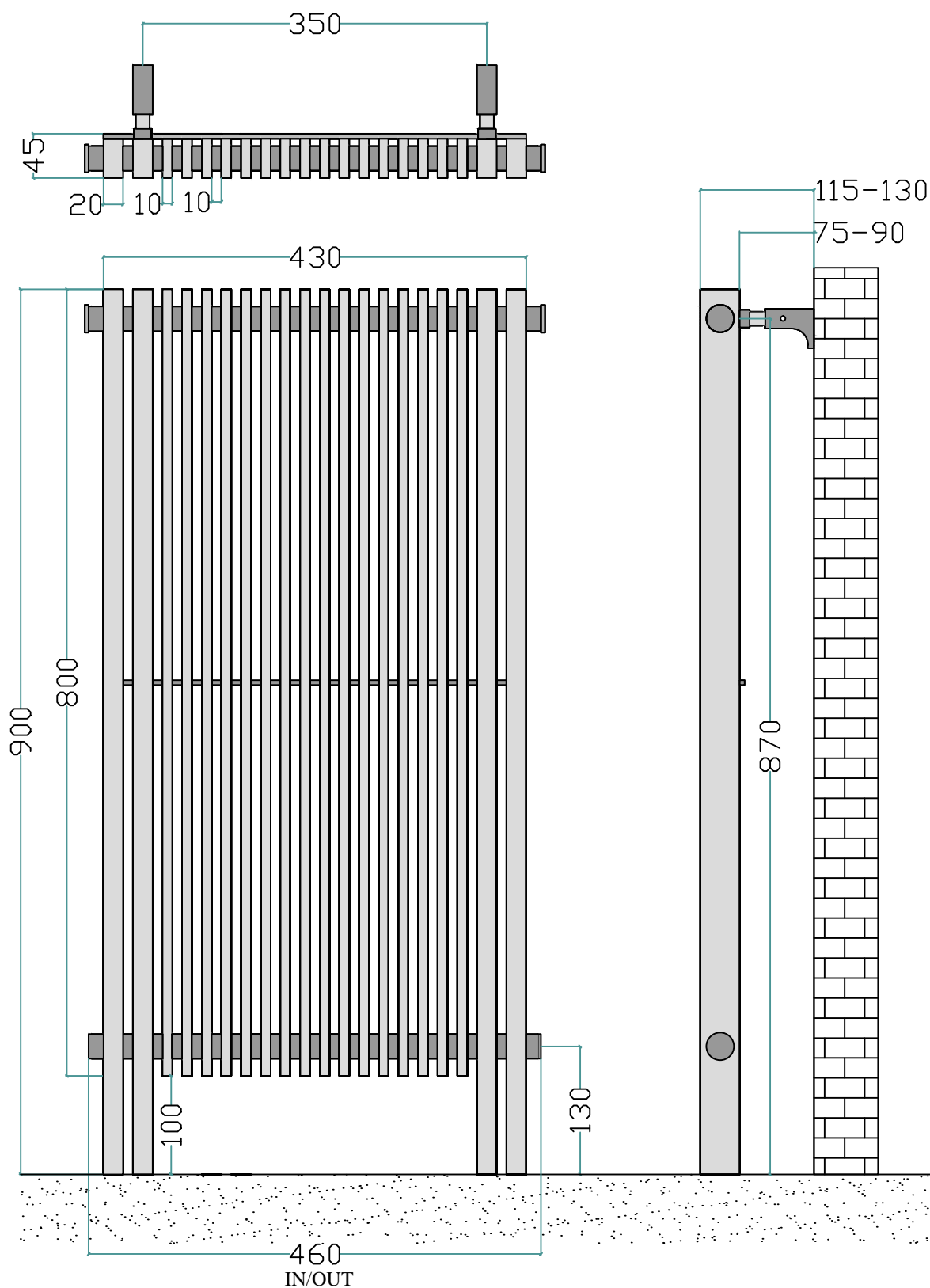

KORLE	Watt	BTU	Watt	BTU
	Δ 50°C	Δ 50°C	Δ 60°C	Δ 60°C
Cadence 90M20	976	3330	1234	4211

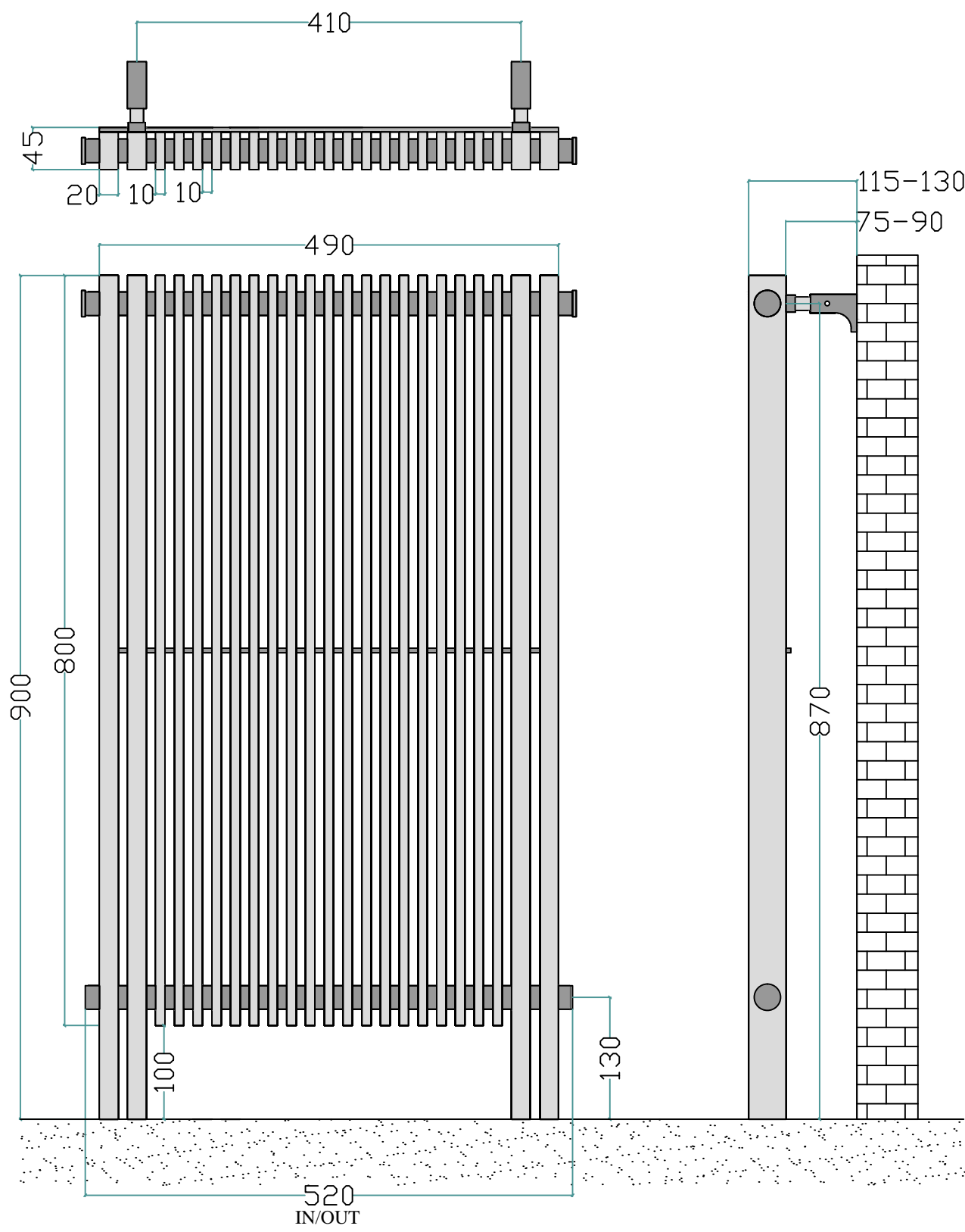

KORLE	Watt	BTU	Watt	BTU
	Δ 50°C	Δ 50°C	Δ 60°C	Δ 60°C
Cadence 90M23	1113	3797	1407	4801

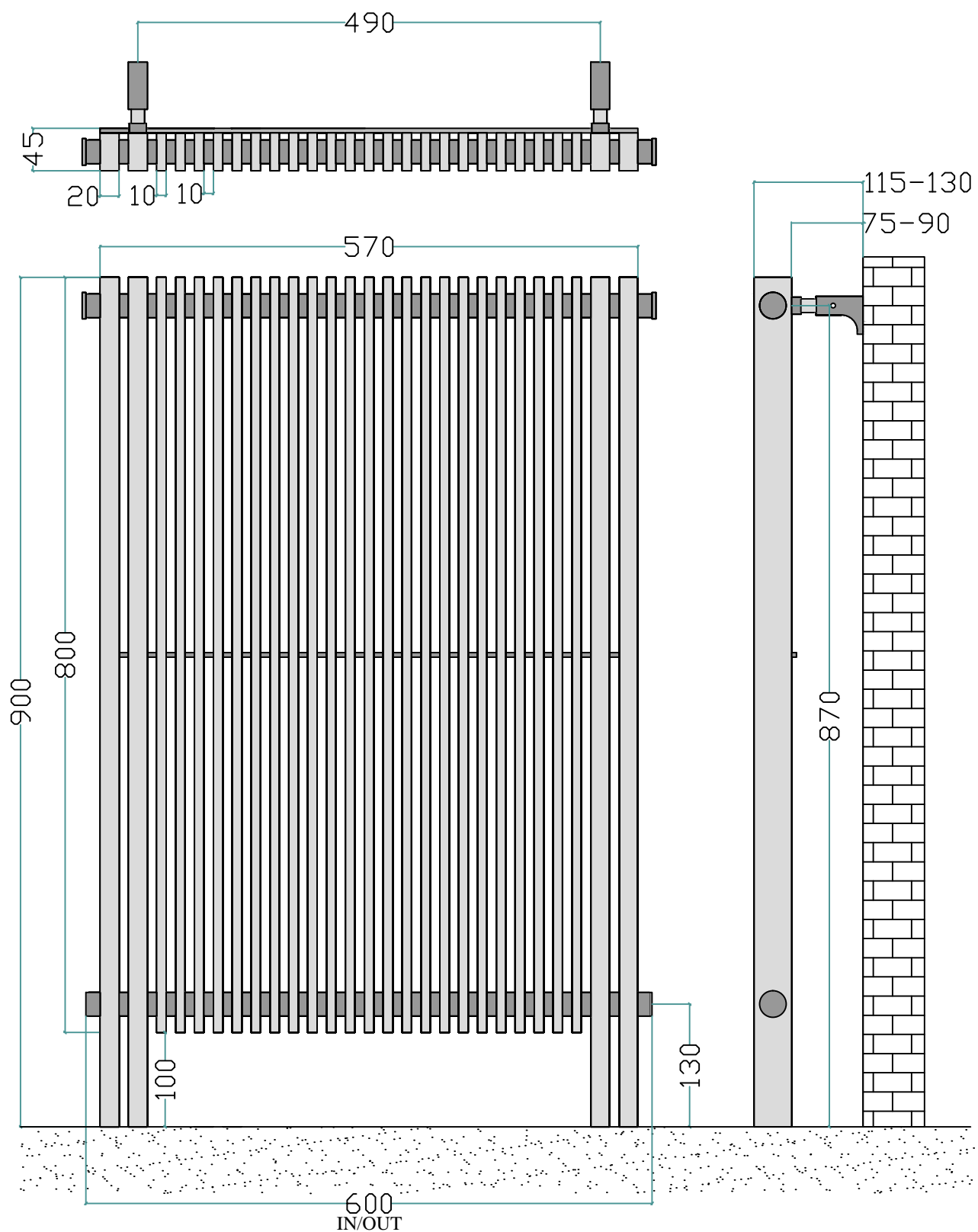

KORLE	Watt	BTU	Watt	BTU
	Δ 50°C	Δ 50°C	Δ 60°C	Δ 60°C
Cadence 90M27	1295	4419	1638	5588

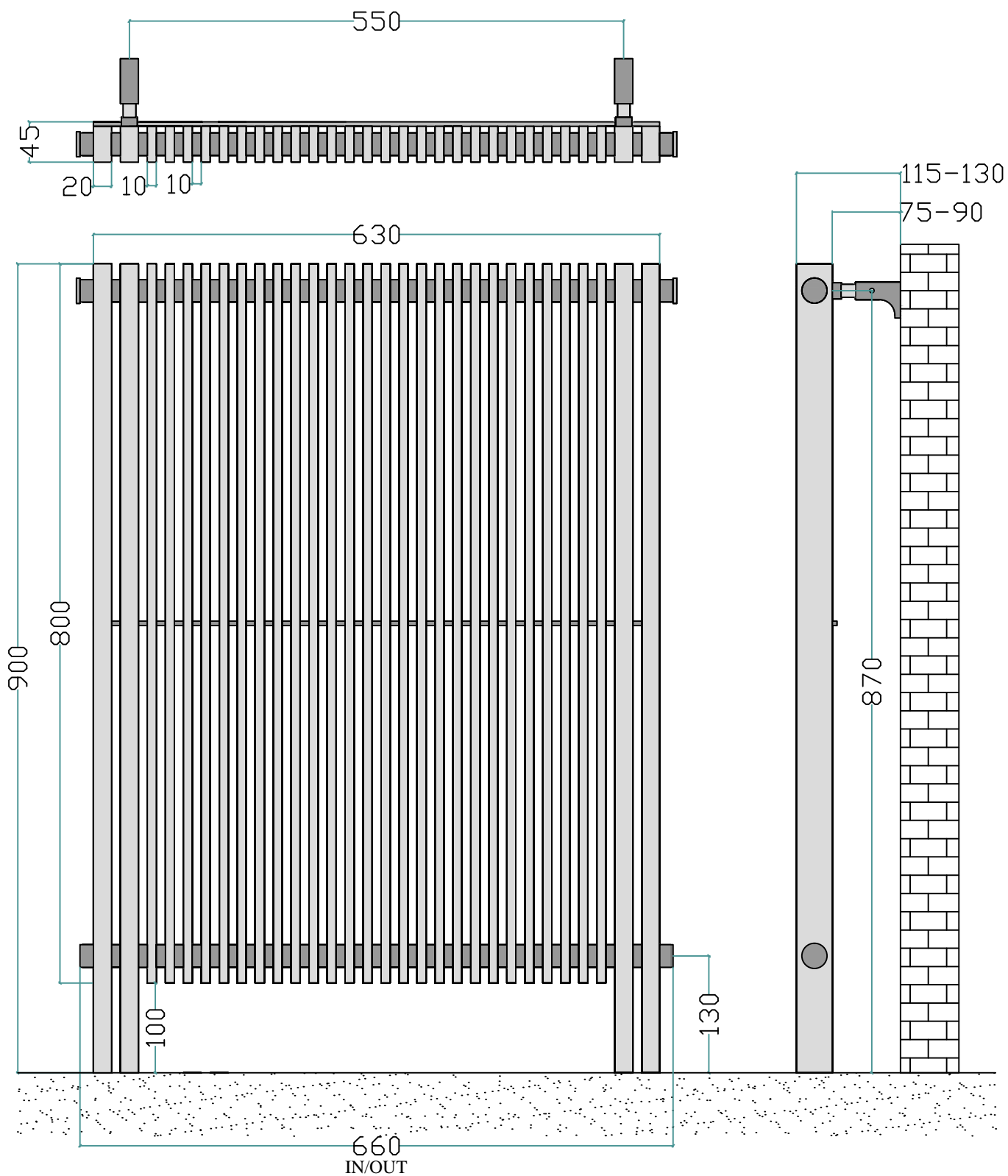

KORLE	Watt	BTU	Watt	BTU
	$\Delta 50^\circ\text{C}$	$\Delta 50^\circ\text{C}$	$\Delta 60^\circ\text{C}$	$\Delta 60^\circ\text{C}$
Cadence 90M30	1432	4886	1811	6178

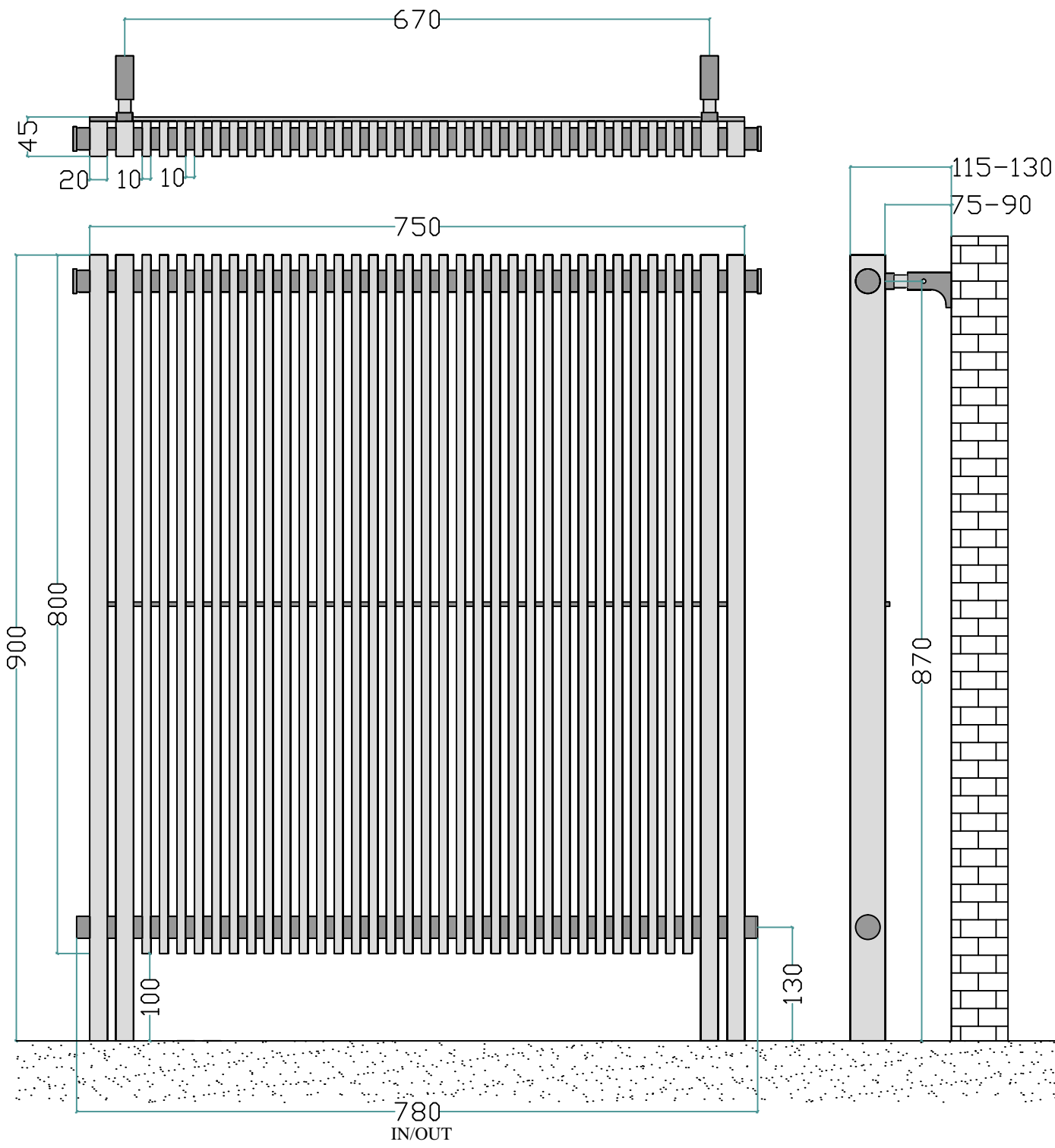

KORLE	Watt	BTU	Watt	BTU
	Δ 50°C	Δ 50°C	Δ 60°C	Δ 60°C
Cadence 90M36	1705	5819	2157	7359

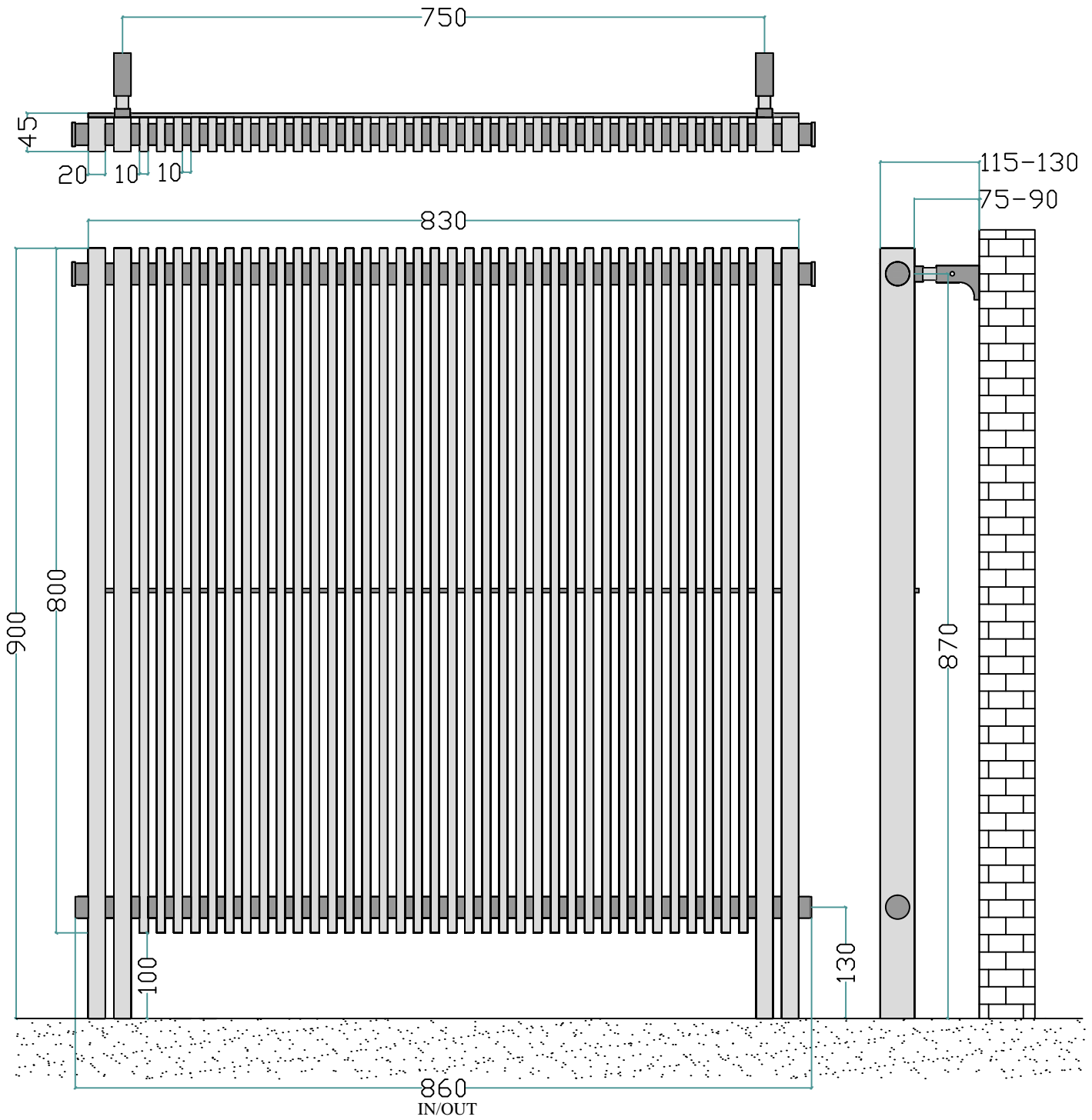

KORLE	Watt	BTU	Watt	BTU
	Δ 50°C	Δ 50°C	Δ 60°C	Δ 60°C
Cadence 90M40	1888	6442	2387	8146

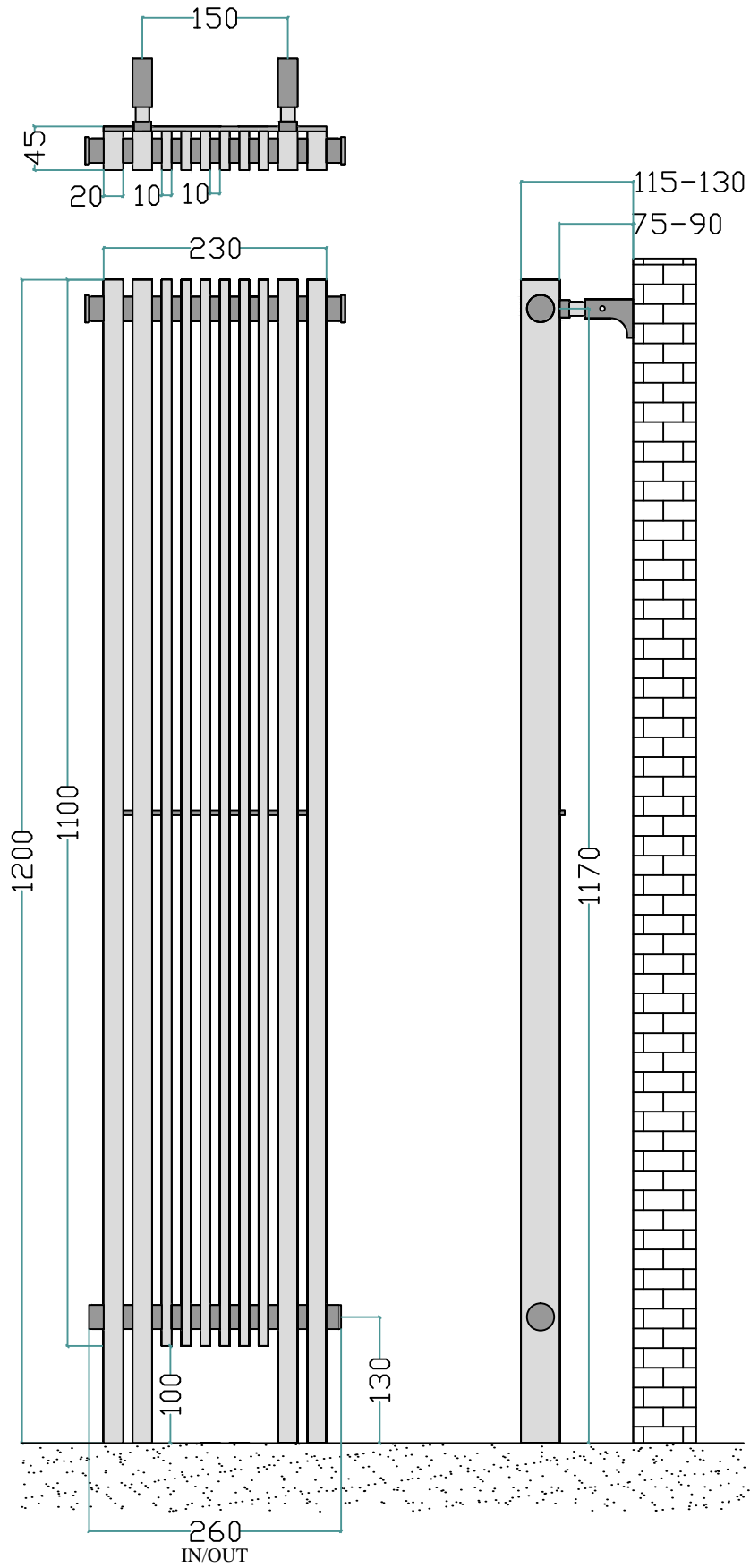

KORLE	Watt	BTU	Watt	BTU
	$\Delta 50^{\circ}\text{C}$	$\Delta 50^{\circ}\text{C}$	$\Delta 60^{\circ}\text{C}$	$\Delta 60^{\circ}\text{C}$
Cadence 120M10	705	2404	891	3040

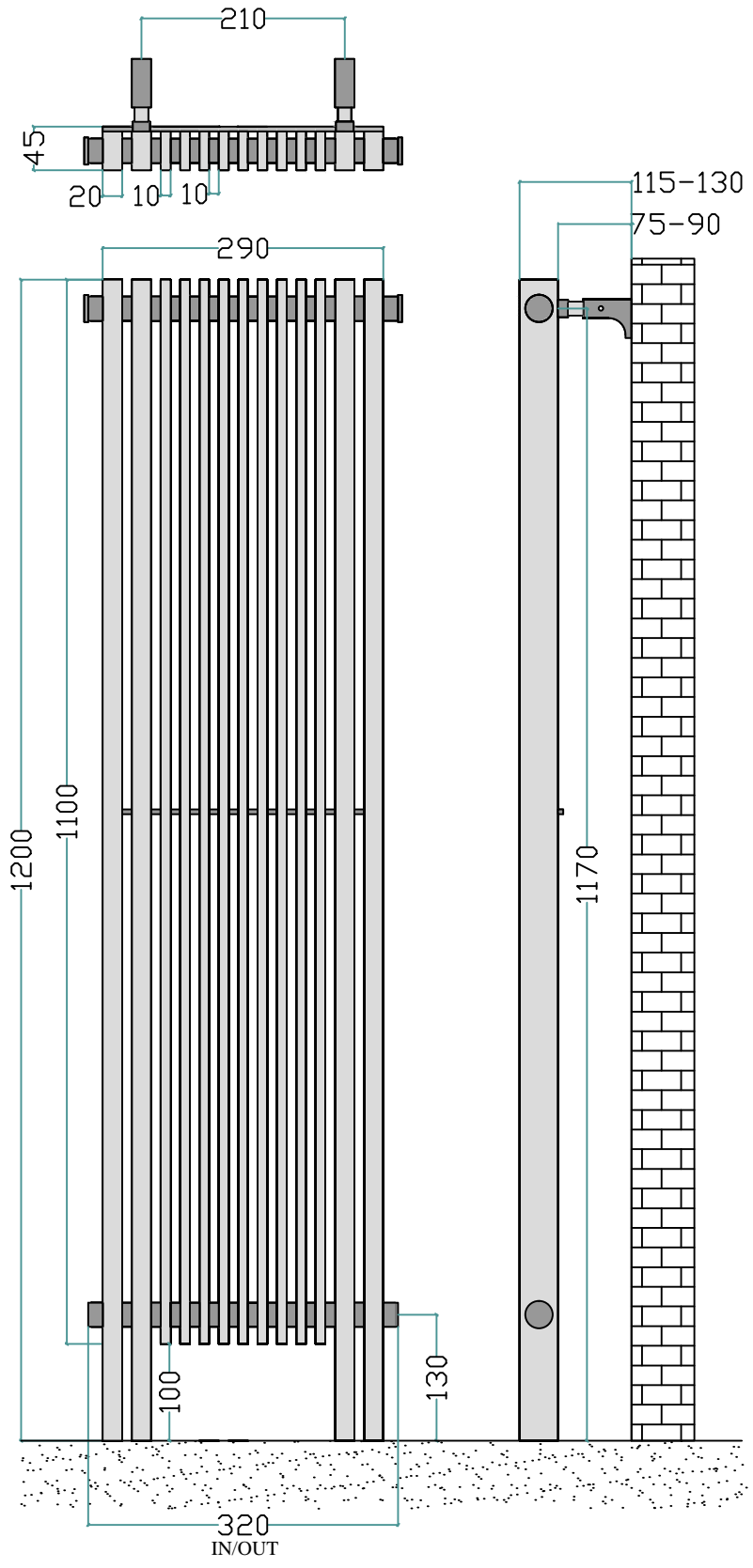

KORLE	Watt	BTU	Watt	BTU
	$\Delta 50^{\circ}\text{C}$	$\Delta 50^{\circ}\text{C}$	$\Delta 60^{\circ}\text{C}$	$\Delta 60^{\circ}\text{C}$
Cadence 120M13	893	3046	1129	3852

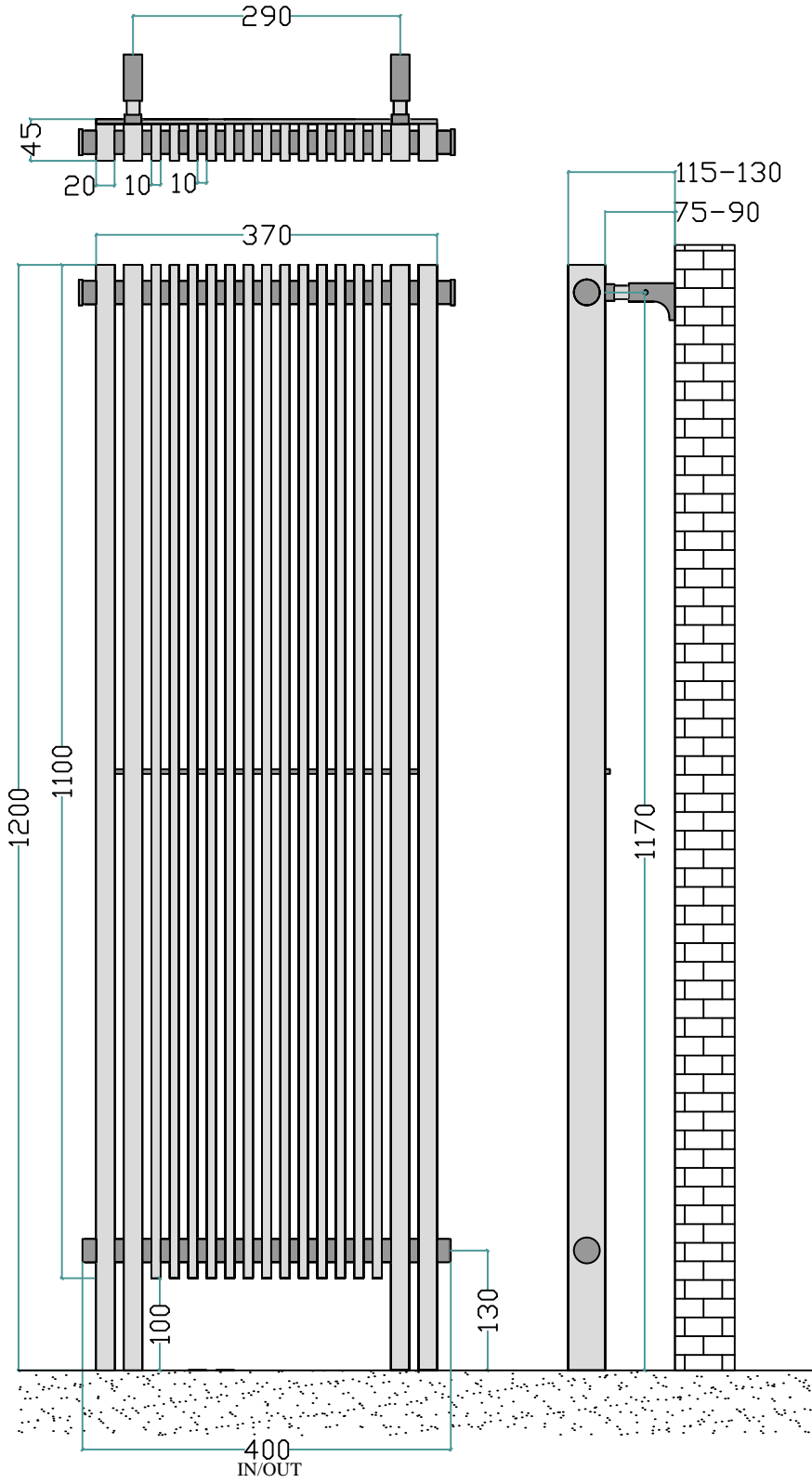

KORLE	Watt	BTU	Watt	BTU
	$\Delta 50^{\circ}\text{C}$	$\Delta 50^{\circ}\text{C}$	$\Delta 60^{\circ}\text{C}$	$\Delta 60^{\circ}\text{C}$
Cadence 120M17	1143	3902	1446	4934

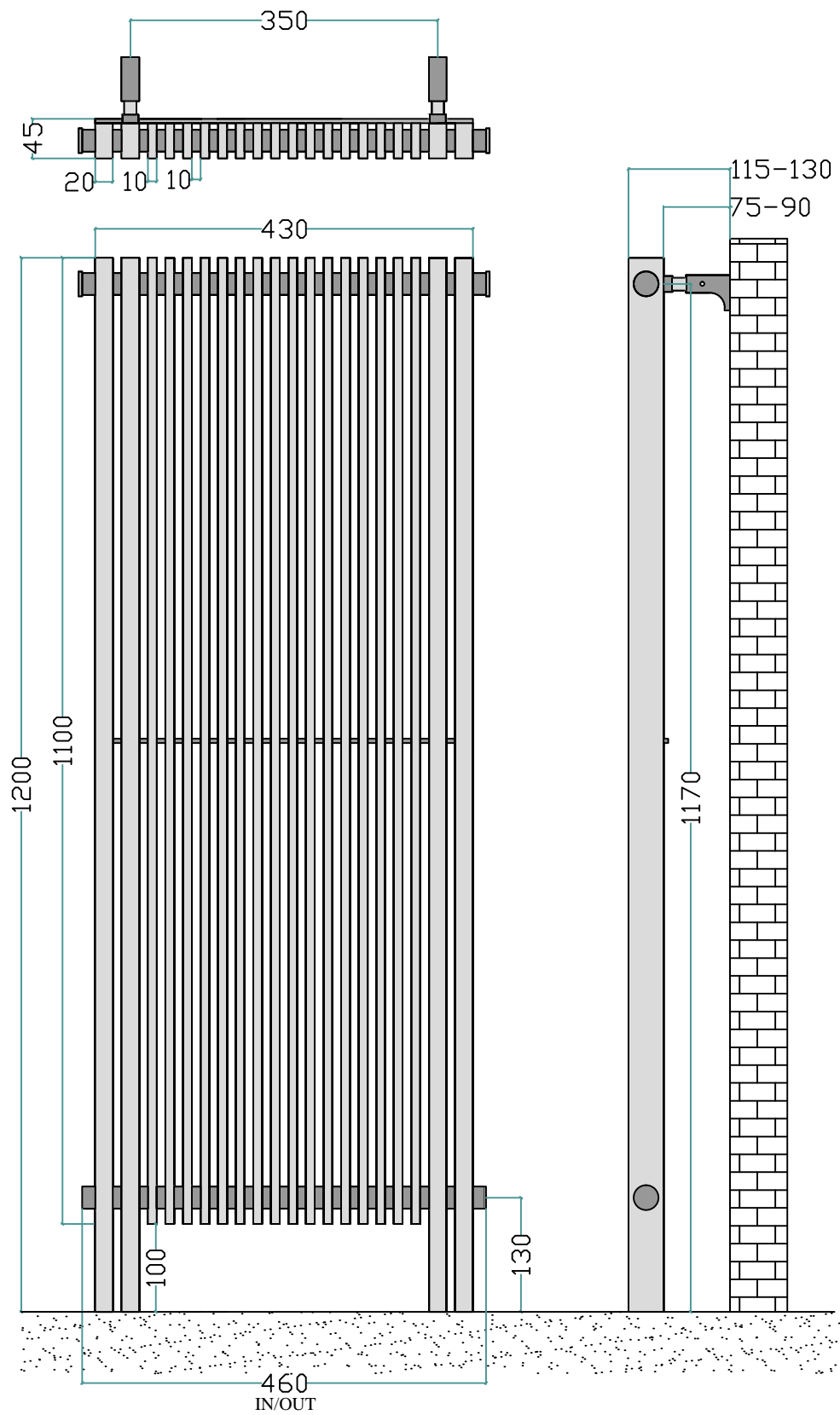

KORLE	Watt	BTU	Watt	BTU
	Δ 50°C	Δ 50°C	Δ 60°C	Δ 60°C
Cadence 120M20	1332	4544	1684	5745

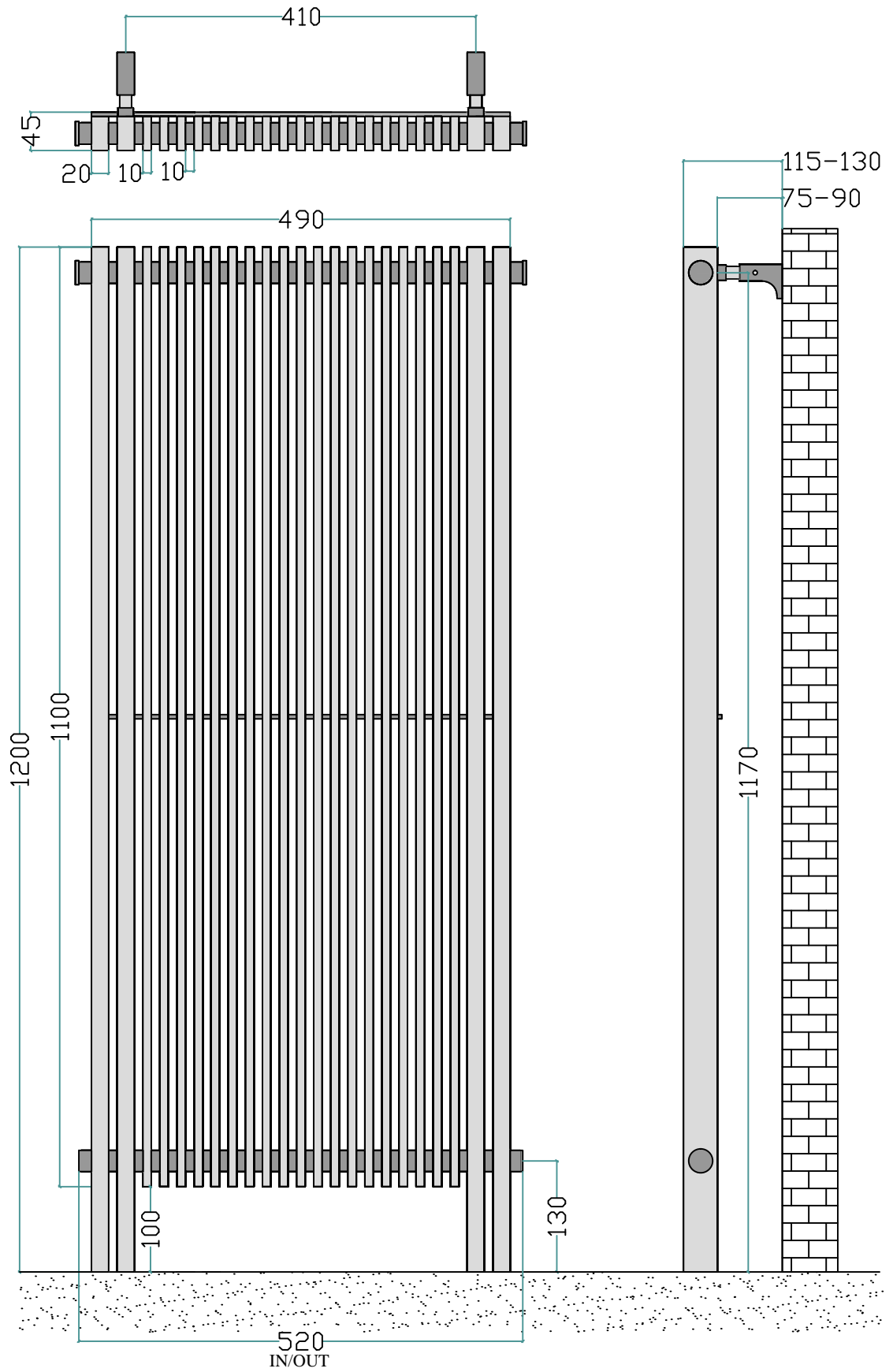

KORLE	Watt	BTU	Watt	BTU
	Δ 50°C	Δ 50°C	Δ 60°C	Δ 60°C
Cadence 120M23	1520	5185	1922	6557

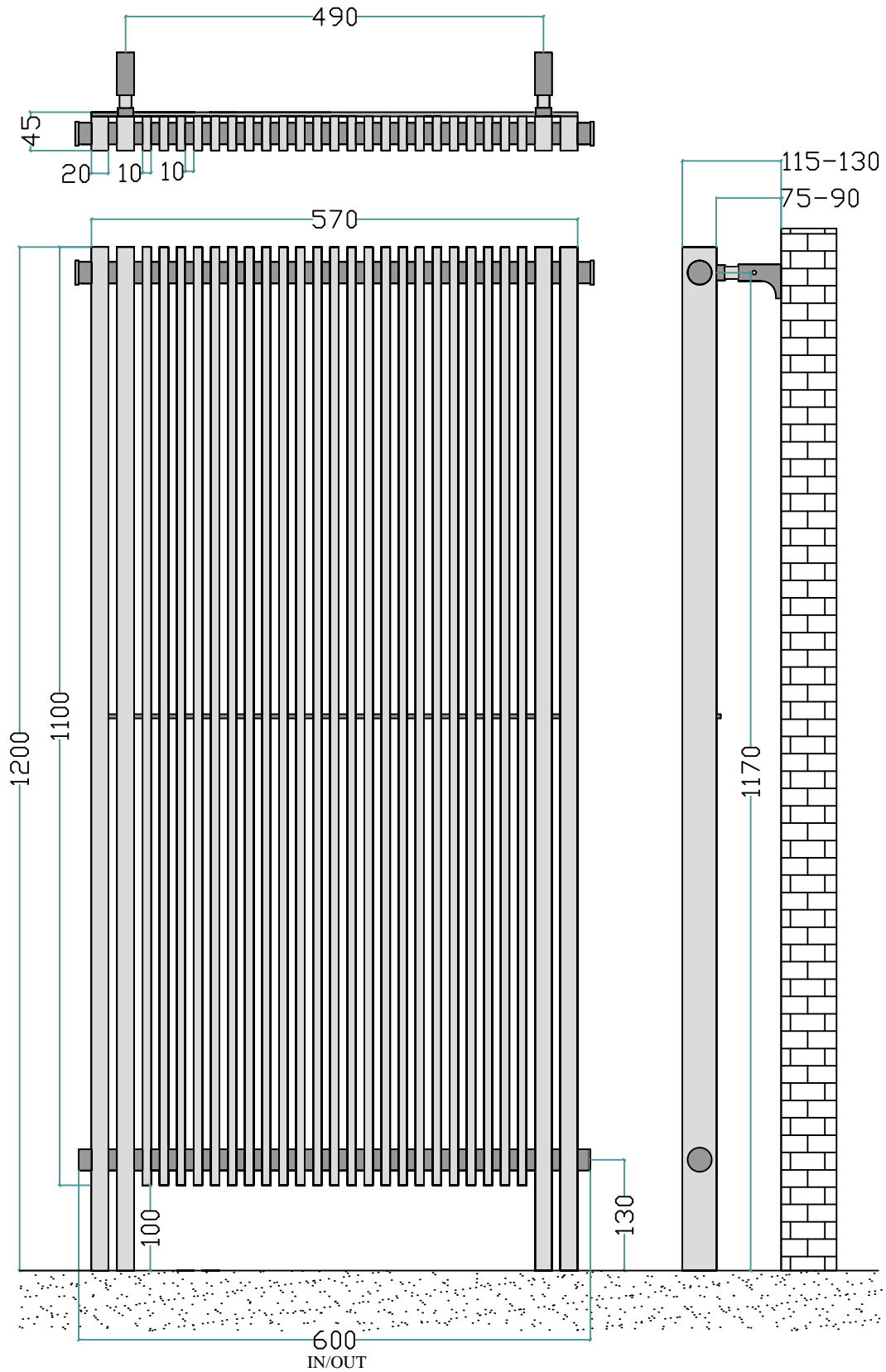

KORLE	Watt	BTU	Watt	BTU
	$\Delta 50^{\circ}\text{C}$	$\Delta 50^{\circ}\text{C}$	$\Delta 60^{\circ}\text{C}$	$\Delta 60^{\circ}\text{C}$
Cadence 120M27	1770	6041	2239	7639

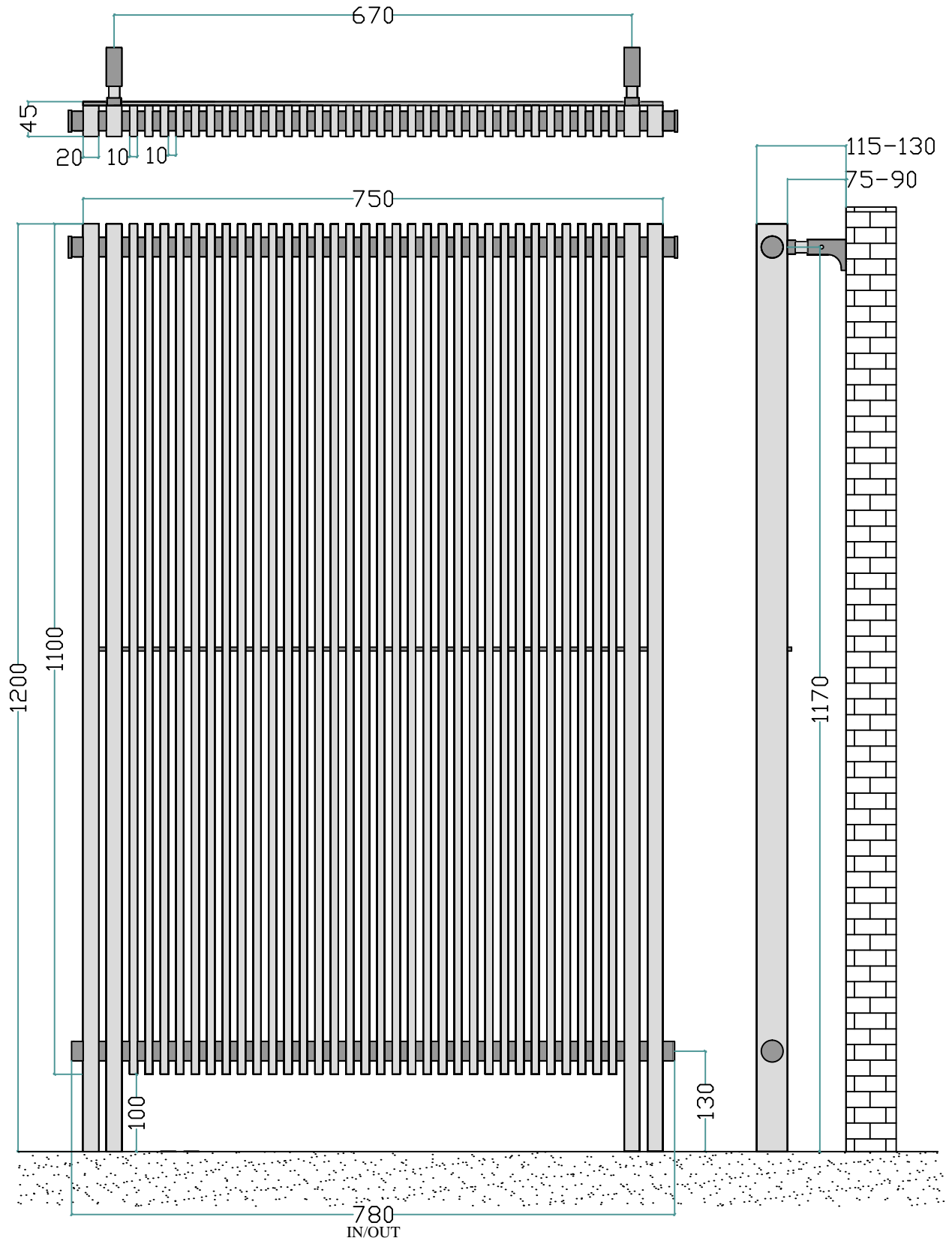

KORLE	Watt	BTU	Watt	BTU
	$\Delta 50^{\circ}\text{C}$	$\Delta 50^{\circ}\text{C}$	$\Delta 60^{\circ}\text{C}$	$\Delta 60^{\circ}\text{C}$
Cadence 120M36	2335	7967	2952	10074

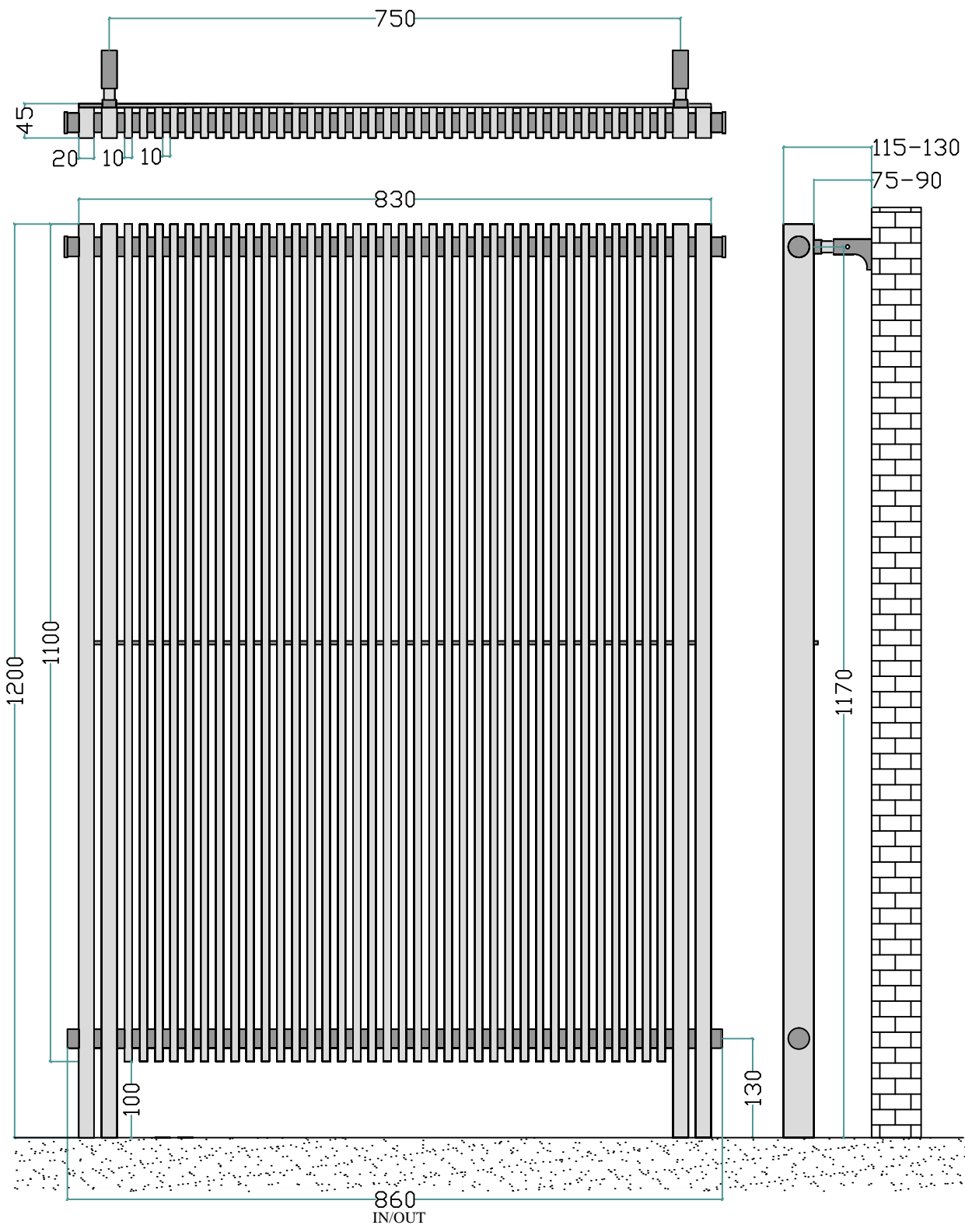

KORLE	Watt	BTU	Watt	BTU
	$\Delta 50^{\circ}\text{C}$	$\Delta 50^{\circ}\text{C}$	$\Delta 60^{\circ}\text{C}$	$\Delta 60^{\circ}\text{C}$
Cadence 120M40	2586	8823	3269	11156