



## 1. Install TV Mounting Bracket

Place the TV face down on a soft surface where it is secure and stable. If your TV is already attached to a base, it must be removed before beginning the installation.

The VESA holes on the back of the TV are either 100mm, 200mm, 300mm, 400mm or 600mm depending on the brand of the TV. This kit includes all sizes.

Attach TV mounting bracket to the **top 2 holes using the appropriate bolts**. This kit also includes different lengths of each size. Hand tighten to choose appropriate length then use a handheld Phillips screwdriver and tighten until snug. **Do not overtighten.**

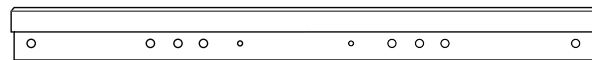

**IMPORTANT**

Too Short

Too Long

Correct

Use washers if bolts are too long

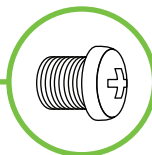

**Note:** It is very important to select the correct bolt length and diameter that fits your specific TV. This kit includes all sizes.

## Installing On Smart TVs

Some smart TVs may have holes located towards the center. Install the TV bracket in holes "closest to top" in relation to any bottom holes.

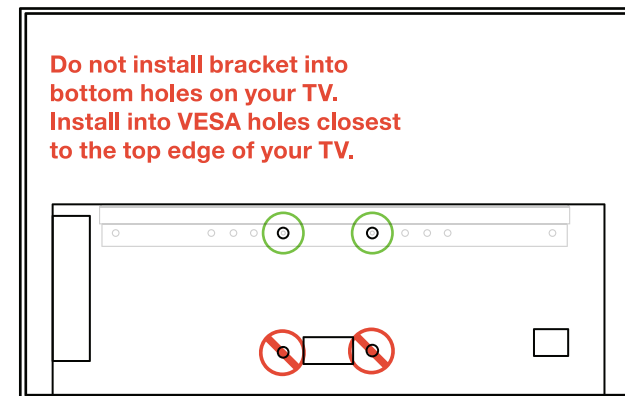

Back of TV

## Installing On Other TVs

Most TVs have 4 holes located on the back in the below configuration. Make sure to always choose the top two holes when installing the bracket.

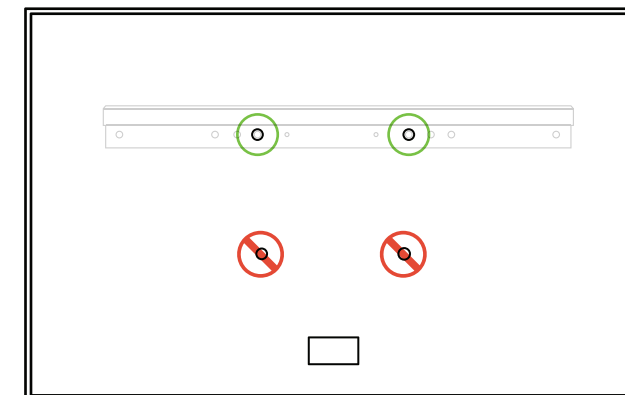

Back of TV

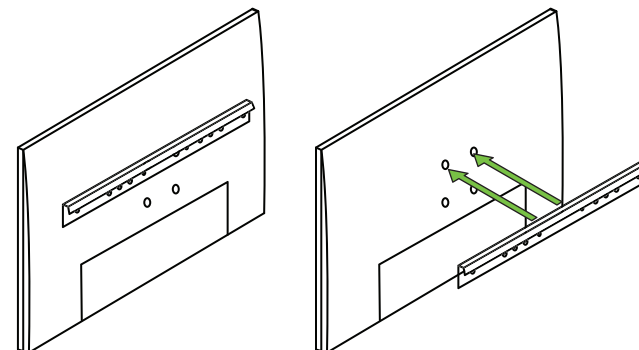

## STEP 2: LOCATE STUD, LEVEL, AND INSTALL WALL BRACKET

Locate studs using the magnetic stud finder. Using a handheld Phillips-head screwdriver, install the wall bracket using Wall-Dog™ anchorless screws.

**DO NOT OVERTIGHTEN**

**TIP:** Install center screw first, then insert level into wall bracket. Once level, install one screw on each end. Lastly, spread out the remaining screws evenly to complete your installation.

### Minimum Wall-Dog™ screw requirement:

- A. Wood Stud & Drywall: 5
- B. Drywall: 11
- C. Brick: 5
- D. Concrete: 5

### Minimum Structural Requirements:



#### A. Wood stud under drywall

Minimum stud size and stud spacing (2x4 stud, 16-in spacing), maximum drywall covering thickness (1/2-in)  
*For direct installations into stud, we suggest using a power screwdriver.*



#### B. Drywall only (No Stud)

Minimum thickness of drywall (1/2-in)  
*When installing into drywall a manual screwdriver must be used to fasten screws to drywall. Do not overtighten the screws.*



#### C. Brick

Solid facing brick, approx. mortar thickness (3/8-in)  
When installing into brick, *drill a 3/16" x 1-3/8" deep pilot hole first*, all fasteners should be fastened into brick and not the mortar.



#### D. Concrete (solid)

When installing into concrete, *drill a 3/16" x 1-3/8" deep pilot hole first.*  
*Minimum thickness (4-in.) and the psi of the concrete (if required PSI is greater than 2500psi)*

★ It's recommended to feed the security cable through the TV bracket before hanging your TV. Please refer to step one of the **Security Cable Installation** on the reverse side of these instructions.



## STEP 3: HANG YOUR TV

Hang TV by engaging the TV bracket on top of the wall bracket. Place against wall and slide down. Lower slowly to ensure proper engagement. TV should be centered on the wall mount - no right or left offset.

### IMPORTANT:

**Make sure to fully and properly engage the TV bracket with the wall bracket.**

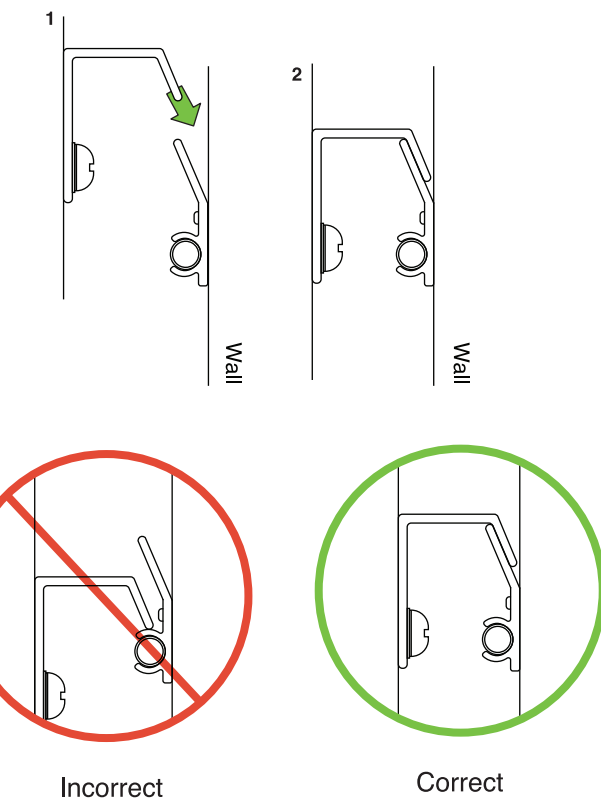

**Parts List:**

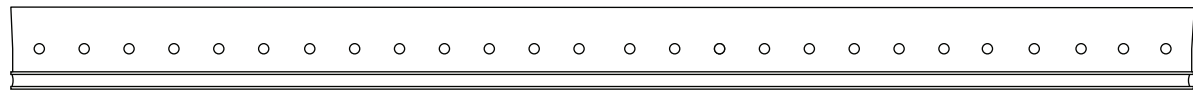

(1) 26" HANGMAN®  
Wall Bracket

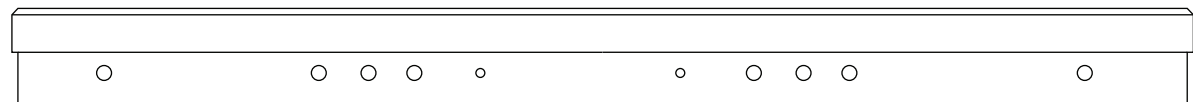

(1) 26"  
TV Bracket



(1) Bubble Level



(2) Small Washers  
For 4mm Bolts



(6) Bolt Washers

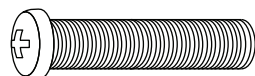

(2) M8 (8mm)  
x 45mm Bolts



(2) M8 (8mm)  
x 35mm Bolts

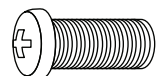

(2) M8 (8mm)  
x 20mm Bolts

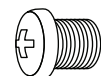

(2) M8 (8mm)  
x 16mm Bolts



(2) M5 (5mm)  
x 35mm Bolts



(2) M5 (12mm)  
x 12mm Bolts



(2) M6 (6mm)  
x 35mm Bolts

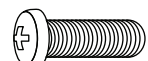

(2) M6 (6mm)  
x 20mm Bolts



(2) M6 (6mm)  
x 12mm Bolts



(2) M4 (4mm)  
x 35mm Bolts



(2) M4 (4mm)  
x 12mm Bolts



(1) Magnetic  
Stud Finder



(3) 1-1/2" Bear  
Claw Screw  
FOR STUDS

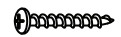

(3) 1" Bear  
Claw Screw  
FOR BRICK / CONCRETE



(3) Anchors

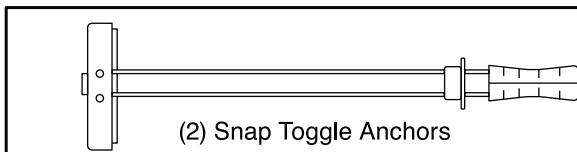

(2) Snap Toggle Anchors

FOR DRYWALL / LATH & PLASTER



(2) 2" Machine Screws



(1) Security cable (1) Bear Claw screw for security cable

**Security Cable Installation**

The weight of the TV in the bracket will hold the TV securely in place under normal conditions. The Security Cable adds an extra layer of protection in case the TV is bumped from underneath.

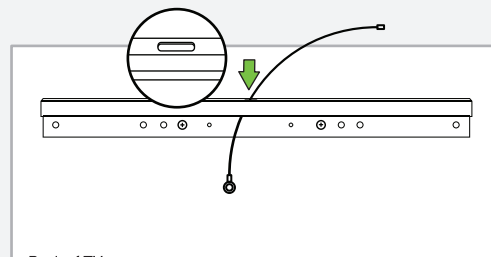

Back of TV

**★ 1. FEED SECURITY CABLE THROUGH TV BRACKET**

Feed cable loop-first through the rectangular opening located on the top of the TV mounting bracket.

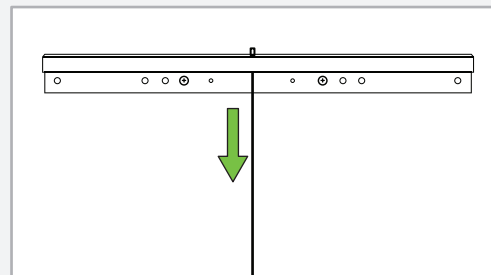

Back of TV

**2. PULL THE CABLE ALL THE WAY DOWN AND ADJUST THE LENGTH IF NEEDED.**

If the security cable is visible below the bottom edge of your TV, tie knots in the cable to reduce its length.

The cable should be 1" from the bottom edge of your TV. Tie multiple knots if needed to achieve this length.

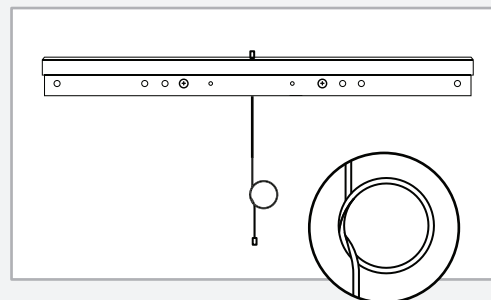

**3. TILT BOTTOM OF TV UP AND FASTEN SECURITY CABLE TO THE WALL**

Tilt the bottom of the TV up to allow access to the security cable. Using a hand held Phillips-head screwdriver, fasten the security cable to the wall. Do not over tighten.

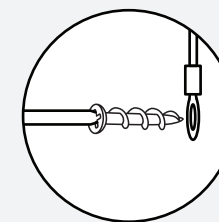
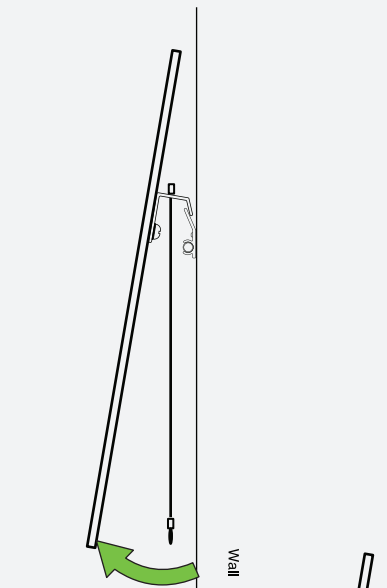

Wall

Wall

S-2060-SF

**HANGMAN**®

hangmanproducts.com

Find us  
@hangmanproducts



Share your installation video with  
#hangitlikeapro for a chance to be featured

Have a question? Give us a call.  
(818)-610-0487 | Mon-Fri | 7am-6pm PST



Scan QR for  
installation video

Check out our No Stud 65" TV Hanger®

Don't want to damage your walls but have a huge TV to hang? We got you.



**WARNING:** Before starting assembly, verify all parts are included and undamaged. If any parts are missing or damaged, do not return to your dealer; contact customer service. Never use damaged parts!

**CAUTION:** This S2065 mount is intended for use only with LED displays weighing up to 80lbs. Use with products heavier than 80lbs may result in collapse of the mount and its accessories causing possible injury.

© Hangman Products 2023