

iDream1168

HEAD MASSAGER

USER MANUAL

OBM Distribution / Breo-USA
13900 Sycamore Way
Chino, CA 91710
<http://www.breousa.com>
info@breousa.com

breo[®]

**Thank you for purchasing
BRE0 iDream1168.**

Please read this manual carefully before using
the product, and keep it in a safe place for future
reference.

Contents

Introduction	3
Inside the Package	3
Function Deployment	4
Preparation	5
Operation	6
Precautions	7-8
Troubleshooting	9
Technical Parameters	9

Introduction

iDream1168 adopts air pressure, vibration, and hot compress massaging technology. It relaxes the ocular region by rubbing and vibration massaging the pressure points around it. This product allows you to enjoy wonderful music while massaging, further relaxing your brain.

Inside the Package

Main Unit, Controller, AC Adapter, Batteries, User Manual, Earphones.



Main Unit

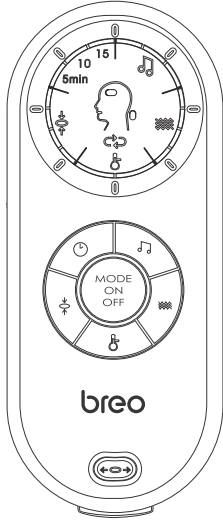

Controller

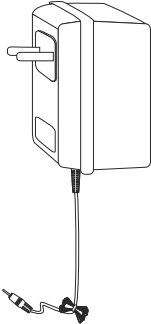

AC Adapter

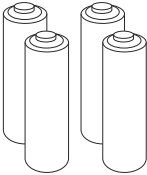

Batteries (AA x 4pcs)



User Manual

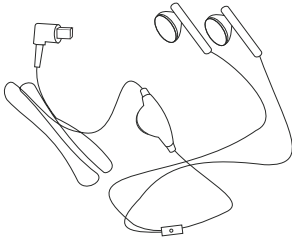

Earphones

Function Deployment

Main Unit

- 1. Tightness Adjusting Knob
- 2. Size Adjusting Knob
- 3. Hindbrain massage heads
- 4. Front part of Main unit

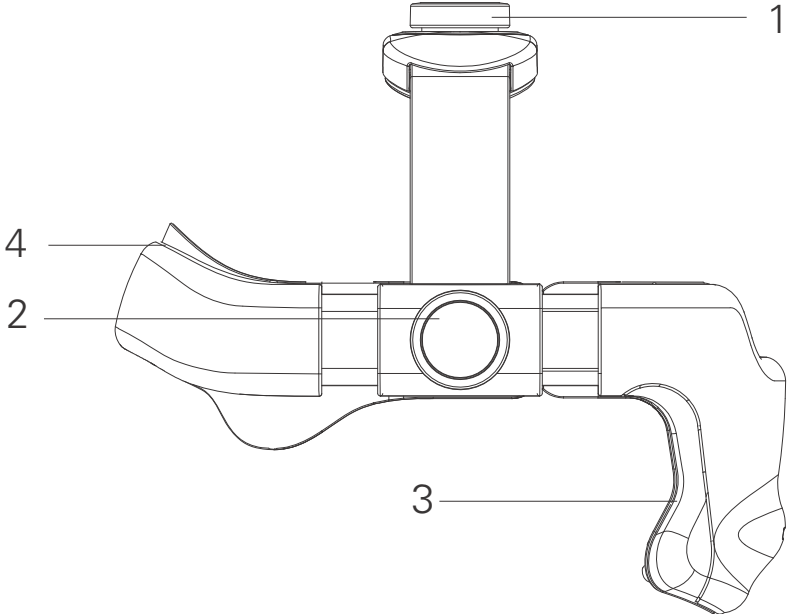

Controller

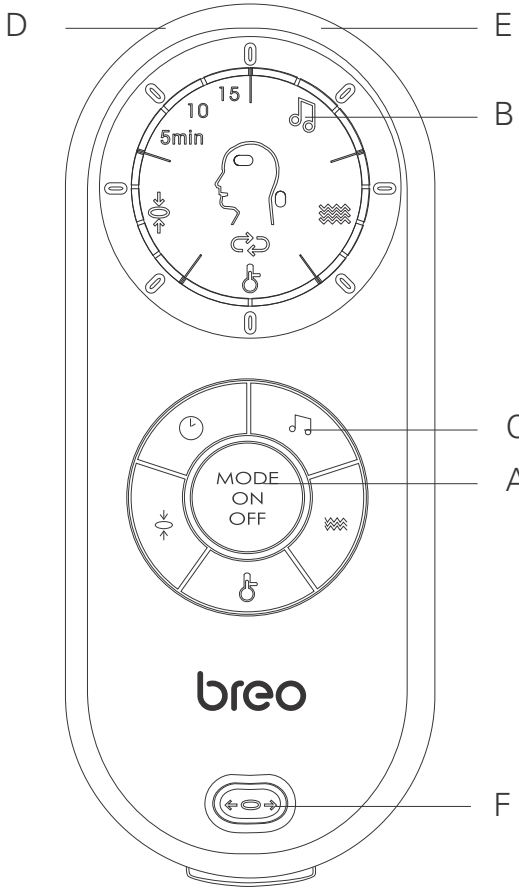

- A . On/Off, Mode Button
- B . LCD Screen
(Clockwise: Music / Vibration / Heat / Air pressure / Time)
- C . Operating Buttons
(Clockwise: Music / Vibration / Heat / Air pressure / Time; Center button: Mode, ON/OFF)
- D . Earphone Jack
- E . DC Power Port
- F . Pressure Reduction Valve

Preparation

Prior to use, check the integrity of the machine and accessories:

- a. No damage on connection between controller and main unit
- b. Battery power is sufficient
- c. No damage on AC adapter

Power Options

1 . Batteries

- a. Open the battery cover on the back of the controller.
- b. Install 4 AA batteries in accordance with the positive and negative poles.
- c. Close the battery cover. (picture1)

2 . AC Adapter

- a. Insert the plug of AC adapter in the controller's DC port.
- b. Connect the other end to AC power socket. (picture2)

* Choose power option #1 OR #2.

Wear

Use the side dials to adjust the distance between head to establish the most comfortable fit, and wear main unit. (picture3a) For ease and safety, use BOTH hands in adjusting the tightness on each side as well as in setting the distance above head. (picture3b)

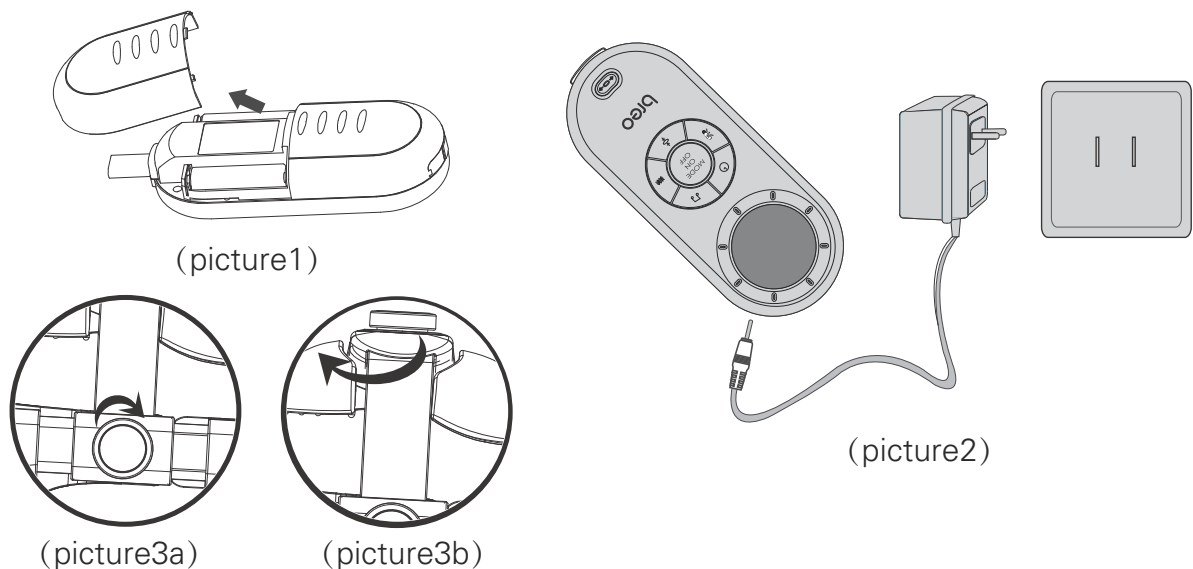

Operation

Power on - Press and hold  Button

Preset default is air pressure + high-temperature hot compress + vibration + relaxing music, 15 minutes duration.

Manually operate related function buttons to switch among music, time, vibration, hot compress, and air pressure modes.

Power off - Press and hold  Button again.

Manual Mode

Time: Press  Button to select massage duration (5 min / 10 min / 15 min)

Music: Press  Button to select music type (Relaxing / Nature)

(*Sounds of Nature featured: running water, birds chirping, waves, crickets, water dripping)

Press and hold  Button to STOP the music

Vibration: Press  Button to initiate 4 vibration modes (circulates automatically)

Heat: Press  Button to select temperature (Low-High)

Air pressure: Press  Button to initiate 4 air pressure modes (circulates automatically)

Mode: Press  to select from 4 different modes:

Air pressure + Hot compress

Air pressure + Vibration

Hot compress + Vibration

Air pressure + Hot compress + Vibration

Tip: When you feel the air pressure is too much and/or uncomfortable, press the Pressure Reduction Valve on the controller to release air.

Precautions

1. Please read the manual carefully and operate accordingly.
2. Children under 7 years old cannot use the massager.
3. This massager should not be used by people who suffer from a brain disease, have had brain surgery, or have a physical or mental disorder.
4. Put on/wear the unit first BEFORE turning the power on.
5. Do not use while walking or driving.
6. Keep the massager away from humidity, heat, and/or corrosive gas.
7. If the massager will not be used for a long time, remove the batteries to avoid battery leakage.
8. This massager is designed as a personal care product. It is not for diagnosis/treatment of any health disorder, nor meant for commercial use.
9. To clean, wipe with aseptic cotton and alcohol. Do not wash or immerse in water.
10. This product is not a substitute for healthcare professionals' advice and treatment. In case of doubt or if necessary, please consult your healthcare professional.
11. This device complies with Part 15 of the FCC Rules. Operation is subject to the following two conditions: (1) this device may not cause harmful interference, and (2) this device must accept any interference received, including interference that may cause undesired operation.
12. Please note that changes or modifications not expressly approved by the party responsible for compliance could void the user's authority to operate the equipment.

13. This equipment has been tested and found to comply with the limits for a Class B digital device, pursuant to Part 15 of the FCC Rules. These limits are designed to provide reasonable protection against harmful interference in a residential installation. This equipment generates, uses and can radiate radio frequency energy and, if not installed and used in accordance with the instructions, may cause harmful interference to radio communications. However, there is no guarantee that interference will not occur in a particular installation. If this equipment does cause harmful interference to radio or television reception, which can be determined by turning the equipment off and on, the user is encouraged to try to correct the interference by one or more of the following measures:
- Reorient or relocate the receiving antenna.
 - Increase the separation between the equipment and receiver.
 - Connect the equipment into an outlet on a circuit different from that to which the receiver is connected.
 - Consult the dealer or an experienced radio/TV technician for help

Troubleshooting & Technical Parameters

When operational problems occur, please refer to the chart below.
Do not disassemble the machine or try to repair it by yourself.

Problem	Possible Reason	Possible Solution
Power-ON failure	Cable is broken / in bad condition	Check the condition of the cable
	Batteries are low / out	Change batteries
	Batteries are not installed correctly	Check if positive/negative poles of batteries are positioned right Make sure the batteries are snug in place
	AC adapter is not connected properly	Check the connection of the AC adapter to the power socket .
Weak heat or air pressure	Batteries are low / out	Change batteries Make sure the batteries are installed correctly and snug in place

Technical Parameters

Power supply : DC: 6V
 Ideal environment: Temperature: 5°C - 40°C
 Relative humidity: : ≤80%
 Atmospheric Pressure: 5-400hpa
 Dimension : Main Unit: 233mm X 269mm X 245mm
 Controller: 158mm X 68mm X 43mm
 Net Weight: 882g
 Power: 6W