

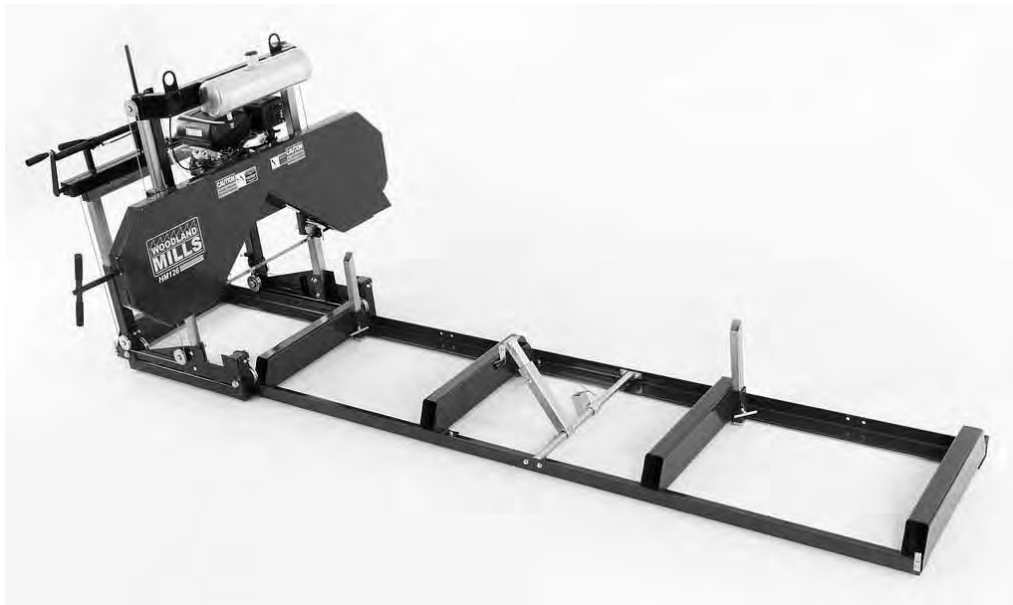

HM126 Sawmill With 9.5HP Kohler Engine

OWNER'S MANUAL



WARNING:

Read carefully and understand all **INSTRUCTIONS** before operating. Failure to follow the safety rules and other basic safety precautions may result in serious personal injury.

Model # HM126

CONTENTS

GENERAL SAFETY RULES	3
GENERAL MAINTENANCE INFORMATION	7
SAWMILL ASSEMBLY INSTRUCTIONS	9
SAWMILL SET-UP PROCEDURES	25
BELT TENSION	25
BLADE TRACKING	27
BLADE GUIDE ADJUSTMENT	31
BLADE TENSION	32
SAWMILL MAINTENANCE	33
CHANGING THE BLADE	33
REPLACING BELTS	33
TROUBLESHOOTING	35
PARTS LIST	36
PART DIAGRAMS	38
NOTES	43

Thank you very much for choosing the Woodland Mills HM126 Portable Sawmill. For future reference, please complete the owner's purchase date: _____

Save the receipt for warranty and these instructions. **It is important that you read the entire manual to become familiar with this product before you begin using it.**

This machine is designed for certain applications only. We strongly recommend this machine is not modified and/or used for any application other than that for which it was designed. If you have any questions relative to a particular application, DO NOT use the machine until you have first contacted us to determine if it can or should be performed on the product.

For technical questions and replacement parts, please contact **Woodland Mills Inc.** at **1-855-476-MILL (6455)**

INTENDED USE

This sawmill is designed for sawing logs while the mill is firmly supported on the ground.

TECHNICAL SPECIFICATIONS

Item	Description
Gasoline Engine	9.5 HP Kohler
Maximum log diameter	26" (660mm)
Maximum Board Width	21" (533mm)
Blade Size	1-1/4 x 144" (32 x 3657mm)

GENERAL SAFETY RULES



WARNING: Read and understand all instructions. Failure to follow all instructions listed below may result in electric shock, fire and/or serious injury.



WARNING: The warnings, cautions, and instructions discussed in this instruction manual cannot cover all possible conditions or situations that could occur. It must be understood by the operator that common sense and caution are factors which cannot be built into this product, but must be supplied by the operator.



WARNING: Only operate the engine in a well ventilated area. Carbon Monoxide produced by the engine during use can kill. Do not use indoors, near windows or in other sheltered areas.

NOTE: All Federal and State laws and any regulation having jurisdiction covering the safety requirements for use of the machine take precedence over the statements in this manual. Users of this machine must adhere to such regulations.

SAVE THESE INSTRUCTIONS

WORK AREA

- **Keep work area clean**, free of clutter and well lit. Cluttered and dark work areas can cause accidents.
- **Do not use your sawmill where there is a risk of causing a fire or an explosion**; e.g. in the presence of flammable liquids, gasses, or dust. Power tools create sparks, which may ignite the dust or fumes.
- **Keep children and bystanders** away while operating a power tool. Distractions can cause you to lose control, so visitors should remain at a safe distance from the work area.
- **Be aware of all power lines, electrical circuits**, water pipes and other mechanical hazards in your work area, particularly those hazards below the work surface hidden from the operator's view that may be unintentionally contacted and may cause personal harm or property damage.
- **Be alert of your surroundings**. Using power tools in confined work areas may put you dangerously close to cutting tools and rotating parts.

INTERNAL COMBUSTION ENGINE SAFETY



WARNING: Internal combustion engines present special hazards during operation and fueling. Read and follow the warning instructions in the engine Owner's Manual and the safety guidelines below. Failure to follow the warnings and safety standards could result in severe injury or death.

- **DO NOT** run the machine indoors or in an enclosed area such as a deep trench unless adequate ventilation, through such items as exhaust fans or hoses, is provided. Exhaust gas from the engine contains poisonous carbon monoxide gas; exposure to carbon monoxide can cause loss of consciousness and may lead to death.
- **DO NOT** smoke while operating the machine.
- **DO NOT** smoke when refueling the engine.
- **DO NOT** refuel a hot or running engine.
- **DO NOT** refuel the engine near an open flame.
- **DO NOT** spill fuel when refueling the engine.
- **DO NOT** run the engine near open flames.
- **ALWAYS** refill the fuel tank in a well-ventilated area.
- **ALWAYS** replace the fuel tank cap after refueling.
- **ALWAYS** check the fuel lines and the fuel tank for leaks and cracks before starting the engine. Do not run the machine if fuel leaks are present or the fuel lines are loose.
- **ALWAYS** avoid contact with hot fuel, oil, exhaust fumes and solid surfaces.

PERSONAL SAFETY

- **Stay alert**, watch what you are doing and use common sense when operating a power tool. Do not use a power tool while you are tired or under the influence of drugs, alcohol or medication. A moment of inattention while operating power tools may result in serious personal injury.
- **Dress properly**. Do not wear loose clothing, dangling objects, or jewelry. Keep your hair, clothing and gloves away from moving parts. Loose clothes, jewelry or long hair can be caught in moving parts. Air vents often cover moving parts and should be avoided.
- **Use safety apparel and equipment**. Use safety goggles or safety glasses with side shields which comply with current national standards, or when needed, a face shield. Use as dust mask in dusty work conditions. This applies to all persons in the work area. Also use non-skid safety shoes, hardhat, gloves, dust collection systems, and hearing protection when appropriate.
- **Do not over reach**. Keep proper footing and balance at all times.
- **Remove adjusting keys or wrenches** before connecting to the power supply or turning on the tool. A wrench or key that is left attached to a rotating part of the tool may result in personal injury.
- **Never make blade guide adjustments, remove or install blades or conduct any other maintenance or make any other adjustments when the engine is running**. Always shut the engine off, remove the ignition key, and keep the engine off before carrying out any of the aforementioned procedures. Consult your engine manual for safe shutdown procedures to prevent accident ignition.

TOOL USE AND CARE

- **Always** be sure operator is familiar with proper safety precautions and operation techniques before using machine.
- **Never touch** the engine or muffler while the engine is on or immediately after it has been turned off. These areas get hot and may cause burns.
- **Always** close fuel valve on engines when machine is not being operated.
- **Avoid “kick-back”** by knowing what conditions can create it.
- **Do not force the tool**. Tools do a better and safer job when used in the manner for which they are designed.
- **Never use the sawmill** with a malfunctioning switch or throttle. Any power tool that cannot be controlled with the switch is dangerous and must be repaired before using.
- **Turn off the engine** and place the switch in the locked or off position before servicing, adjusting, installing accessories or attachments, or storing. Such preventive safety measures reduce the risk of starting the power tool accidentally.

- **Secure logs** with the log screw clamping device instead of with your hand or another individual's help. This safety precaution allows for proper tool operation using both hands.
- **Storing sawmill.** When the sawmill is not in use, store it in a dry, secure place or keep well covered and out of the reach of children. Inspect the sawmill for good working condition prior to storage and before re-use.
- **Maintain your sawmill.** It is recommended that the general condition of the sawmill be examined before it is used. Keep your sawmill in good repair by adopting a program of conscientious repair and maintenance in accordance with the recommended procedures found in this manual. If any abnormal vibrations or noise occurs, turn the sawmill off immediately and have the problem corrected before further use.
- **Keep saw blades sharp and clean.** Properly maintained bandsaw blades are less likely to bind and are easier to control.
- **Cleaning and Lubrication.** Use only soap and a damp cloth to clean your sawmill. Many household cleaners are harmful to plastic and rubber components on the sawmill.
- **Use only accessories that are recommended** by the manufacturer for your model. Accessories that may be suitable for another sawmill may create a risk of injury when used on the HM126 sawmill.
- **Always** operate machine with all safety devices and guards in place and in working order. DO NOT modify or make changes to safety devices. DO NOT operate machine if any safety devices or guards are missing or inoperative.
- **Never leave sawmill running unattended.**
- **Coiled blades can spring apart with considerable force and unpredictably in any direction.** Always deal with coiled blades, including those packaged in boxes, with the utmost care.
- **Never use the equipment to cut anything other than lumber** or for any purpose other than cutting lumber as described in this manual.

EQUIPMENT OPERATION

1. Wear heavy-duty work gloves, ANSI-approved goggles behind a full face shield, steel-toed work boots, and a dust mask.
2. Operate only with assistance.
3. Fill the lubrication tank with clean water and liquid soap.
4. Start and operate the engine according to the provided engine manual.
5. Depress the throttle to bring the blade up to speed.
6. Throttle should be fully depressed when the saw is under load.
7. Cut branches off the lumber to be processed.

8.  **WARNING:** to avoid death or serious injury. Do not cut lumber with foreign objects in it such as nails, any metal pieces, etc.
9. Place the lumber to be cut on the supports.

10.  The operator and any assistants must stay clear of the front and back of the blade whenever the engine is on.
11. Move the saw head slowly along the track and against the lumber to make the cut.
12. Trim off the rounded sides of the log.
13. When the log is squared-off, boards or posts can be cut to custom specifications.
14. To prevent accidents, turn off the engine and disconnect its spark plug wire after use. Wait for the engine to cool, clean external parts with a clean cloth, then store the equipment out of children's reach.

MAINTENANCE

Proper and routine maintenance is critical to operator safety, achieving good milling results and to prolonging the life of your investment.

1. **Bandwheel Bearings** — Should be inspected before use to ensure they are not worn. Bearings are sealed and do not need to be greased.
2. **Blade Guide Bearings** — Inspect before use for excessive grooves or scoring in the bearing case. Replace if necessary.
3. **Blade Tension** — Grease threads of tensioning “T” handle when dry or as required. Use multi-purpose, extreme-pressure grease.
4. **Log Screws** — Grease frequently.
5. **Belts** — Periodically check the condition and wear of the drive and idler belt. Ensure that the blade does not ride on the bandwheels.
6. **Drive Belt** — Periodically check the tension of the drive belt. It should deflect by no more than 1/2".
7. **Sawhead Locking Cam Handles** — Grease assembly every 30 days or as required.
8. **Sawhead Vertical Posts** — Spray posts before use with a silicone spray lubricant such as 3-in-1 or Jig-A-Loo.
9. **Bandwheel Guards** — Routinely remove any build-up of sawdust that may collect inside the bandwheel guards.
10. **Lubrication Tank** — Only fill with a water/laundry detergent mixture or in winter months, use windshield washer fluid. Do not leave lubricant in tank if temperatures fall below 0 degrees Celsius.

11. **Blade Lubricant** — Never use diesel fuel or kerosene as blade lubricant. These substances lead to premature wear of your belts and poor sawing performance. For winter operations, replace the water lubricant with windshield washer fluid.
12. **Engine** — Check the engine oil level before each use and maintain the engine as per the instructions set out by the engine manufacturer in the engine manual.
13. **Sawhead Lifting Cables** — Regularly before, during and after operations, inspect the cables for any wear or kinks. Ensure that the cables are in perfect condition. Oil coiled part of cable often to prevent premature wear. Replace with new cables as necessary.

SAWMILL ASSEMBLY

#1 – INSPECTION

Take all of the parts out of the shipping crate and lay them out. Check for any damage or missing parts.



#2 – TRACKS

Assemble track system and secure loosely with provided nuts & bolts. It is important not to fully tighten the bolts at this stage. This will be done after the head is assembled and rolled along the track. It is ideal to assemble the tracks on a solid and level footing that is a minimum of 4" off of the ground. This will allow for easy cleanup of sawdust from under the tracks and height adjustment of the log supports.





Attach track cross supports to “L” channel with the provided nuts & bolts. The joining plate is used at the seam joint to join the two sections together (shown in top right image). Ensure to only hand tighten at this stage. The bolts will be fully tightened once the head assembly is free to roll on the tracks and provide the correct track width.



Assemble carriage stops at the ends of the tracks (4 stops total) and tighten.

#3 – LOG DOG & SUPPORTS

Assemble log dog pieces as shown below and use water proof grease on threaded handle and “T” handle. Attach assembly to the track using the provided nuts & bolts and tighten.

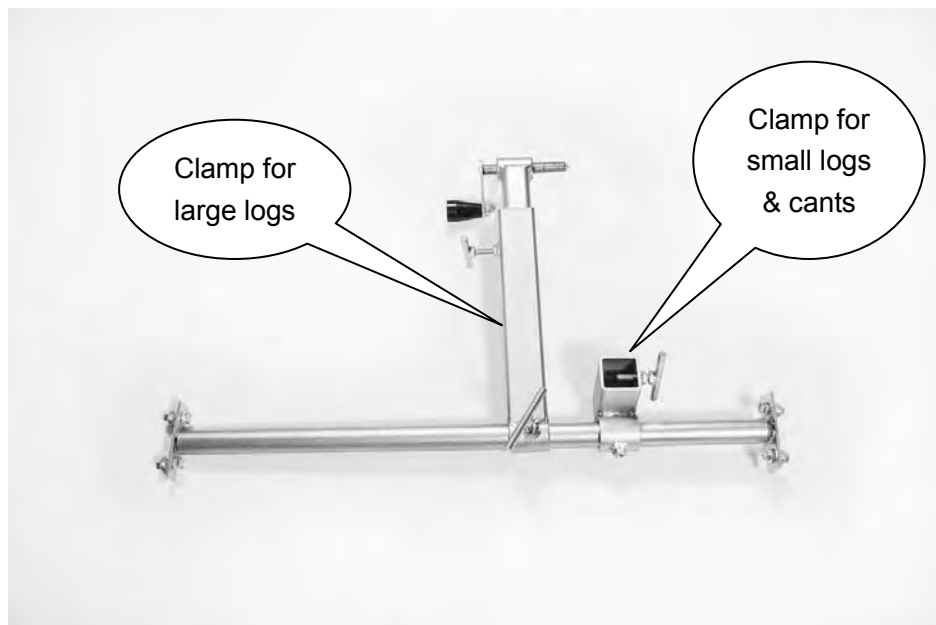

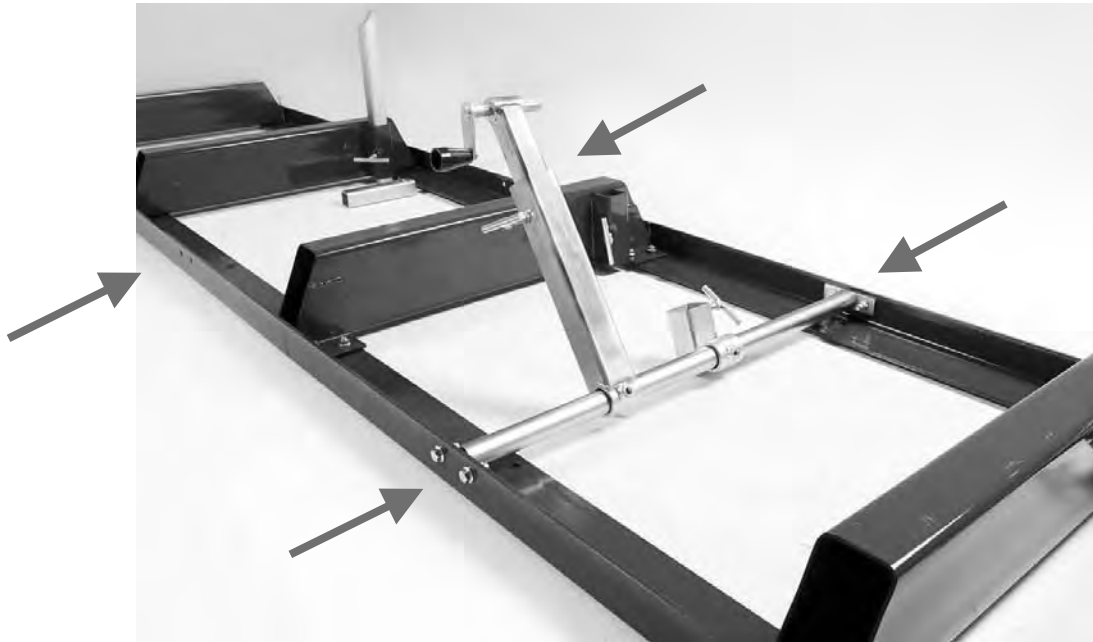

Attach log dog assembly to track as shown above with the 4 nuts and bolts provided. Note that there are various locations along the track where this assembly can be bolted. Depending on how many track sections are being used, select a log clamp position that will secure the log firmly against the log supports.

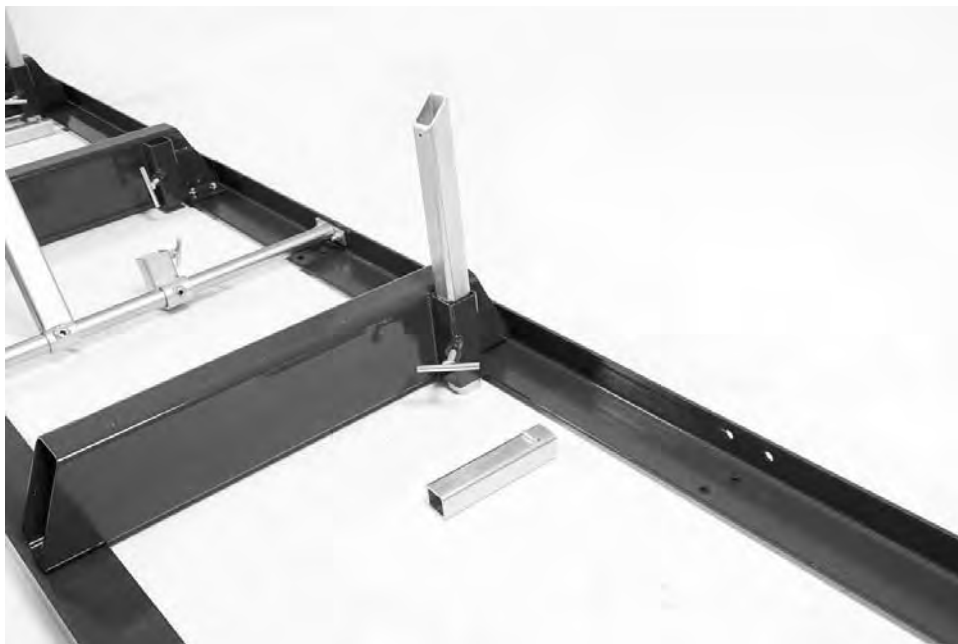

Insert log supports into track cross supports and secure with “T” handles. The “T” handle threads should be coated with waterproof grease. The sawmill includes two sets of log supports – a short set and a long set. The longer set is ideal for larger logs and the shorter set is ideal for small logs and square cants.

#4 – CARRIAGE ASSEMBLY



Lay the above carriage pieces out.

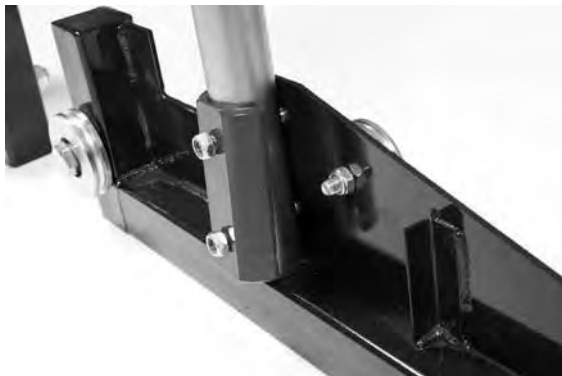

Assemble round vertical post (shown on left) to wheel assembly using the two bolts and back plate. Repeat same step for the square vertical post assembly (shown on right).

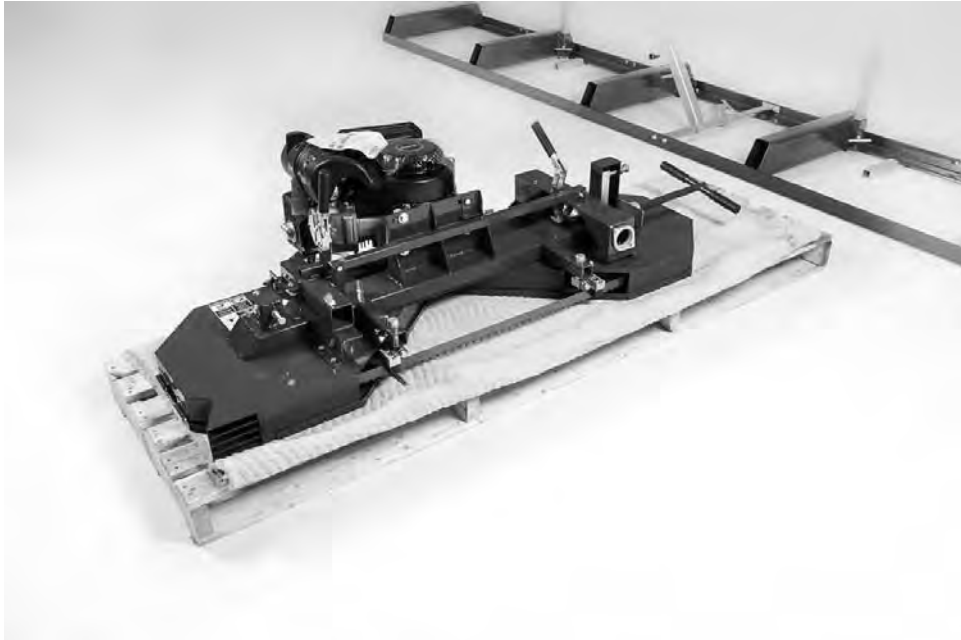

Place a moving blanket on the shipping pallet that the sawmill crate was strapped to. The blanket will prevent the blade guard covers from becoming scratched. Using a **minimum of two people** or a mechanical advantage system, remove the head assembly from the sawmill crate and place face down on the blanket. The head assembly is very heavy, proper technique must be used to avoid injury or damage.



Insert vertical post assemblies into corresponding locations in head assembly as shown above.



Insert the rear square frame into the carriage base until it bottoms out on the pulley bolts. Tighten the four 16mm bolts (shown in right image) to secure it in place.

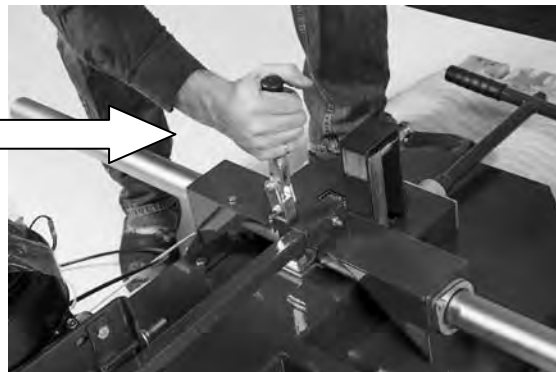

Lock the cam handles on both the round and square post to prevent the head from moving when it is stood up in the coming steps. Ensure that when activating the cam handles, the clamps securely lock on the round and square vertical post. If they don't, a 13mm wrench will need to be used to tighten the adjustment nut. This will allow the clamps to lock on the post better.



With one person on each post, stand the head assembly up on the wheels as shown above. Again, using a **minimum of two people**, set the saw head assembly on the track system ensuring the carriage wheel grooves rest on the "L" rails. The square vertical post should be on the same side as the log supports.



Slide the top cross support over the round post and insert the pulley, collar and bolt assembly into the hole.



Install the nut on the inside of the round post to secure the pulley. Using a 16mm wrench to hold the nut, tighten the bolt.



Insert the bolts into the back plate as shown in above left image. Align the square post holes with the corresponding black top cross support holes. Tighten using an 18mm socket.

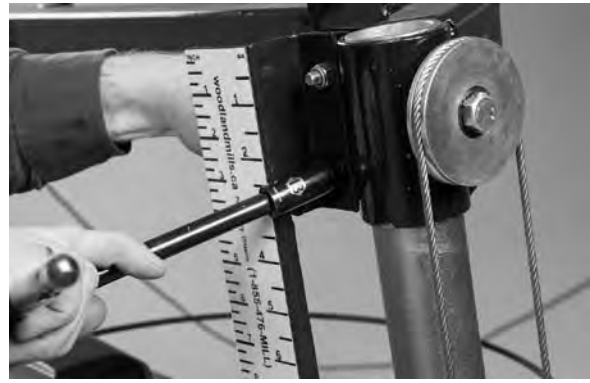

Place the measuring scale bracket as shown above and insert bolts and nuts. It is important to alternate tightening of the nuts (top then bottom) to ensure the black round clamp begins to compress evenly on both the top and bottom until flanges meet at outer edge. Tighten nuts using a 13mm socket.



Install the square indicator rod to the sawmill using the two bolts and tighten using a 10mm socket.



Slide the scale indicator over the square rod and tighten.



Attach the crank handle assembly to the rear square frame using the two 16mm bolts provided (left image). Next, attach the cable bolts to crank handle assembly as shown above in right image.

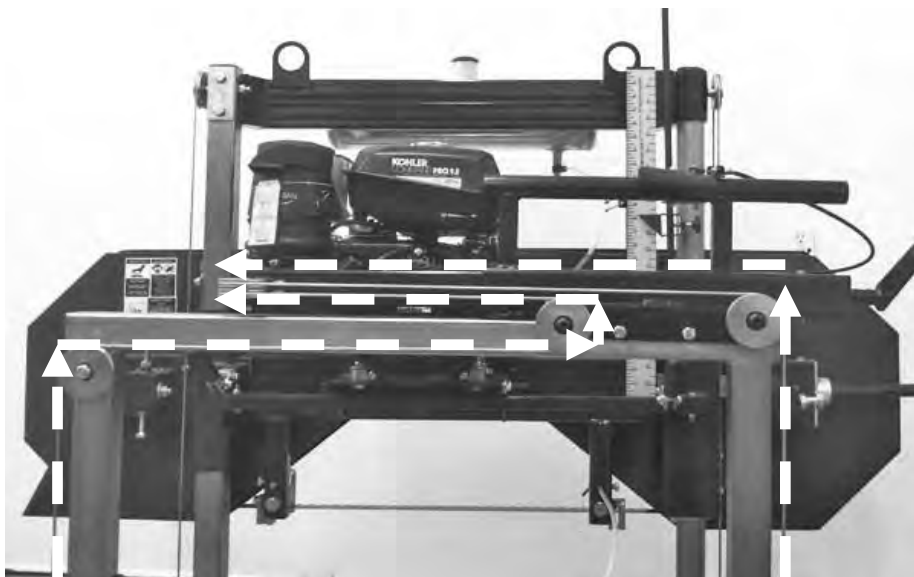
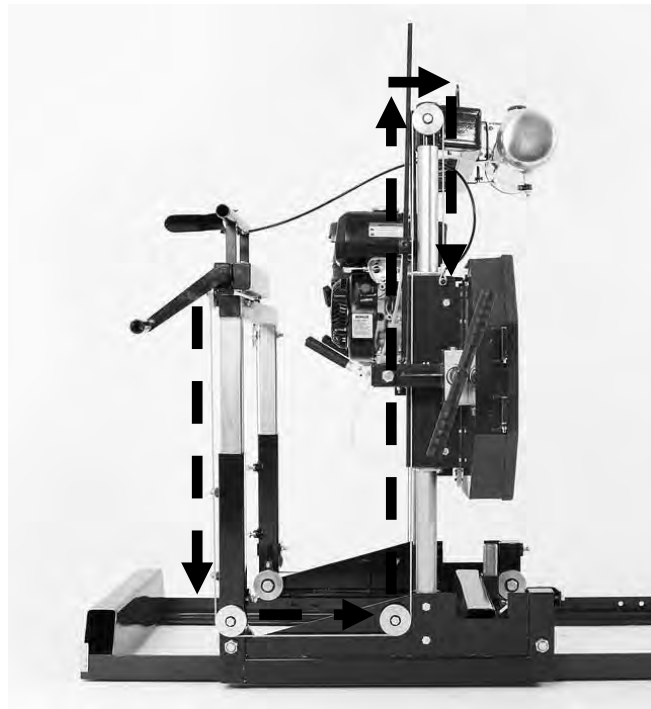

Route the cables on both sides as shown in the above two images.



Using a tape measure, take a measurement from the blade to the top of the log bunk on both the left and right side. The distance should be equal on both sides. If it isn't, you will need to adjust the cable ends at the rear handle to either raise or lower one side. Refer to below step for adjustment instructions.



Using a 14mm socket, turn the nut either clockwise to raise one side of the saw head or counter-clockwise to lower one side of the saw head. Double check the blade height as discussed in the previous step. Once measurement is consistent on both sides, tighten the corresponding nut to clamp securely against tab.



Install the cover and tighten the two bolts on the top and two on the bottom to secure it in place. Use a 10mm socket for all four bolts.



Install the aluminum lube tank to the top cross support using the four nuts and bolts provided.



Install the lube tank line to the bracket on the scale by using a Phillips head screw driver and adjustable wrench.



Insert the lube tank line through the hole in the bottom of the saw head as shown above. Use a 16mm socket to secure the copper end in position. Do not over tighten or crush the copper end.

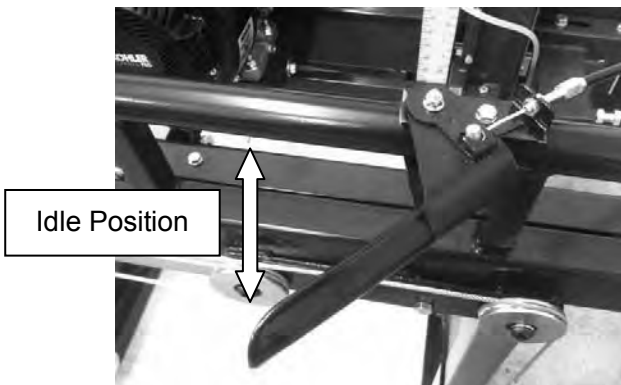

Install the throttle handle to the round bar as shown in above left image. With the throttle lever in the idle position/fully open, pull the cable tight at the engine and tighten the screw to hold it in place. This will take all of the slack out of the cable.



Attach the four track sweepers to the frame so that the steel brush reaches the bottom of the groove in the carriage wheels. Use a 13mm socket to fasten.

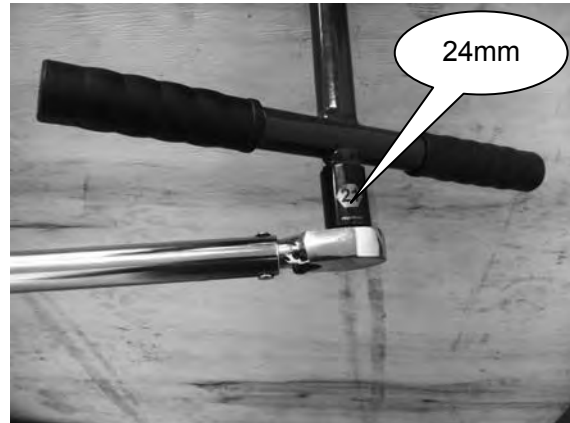
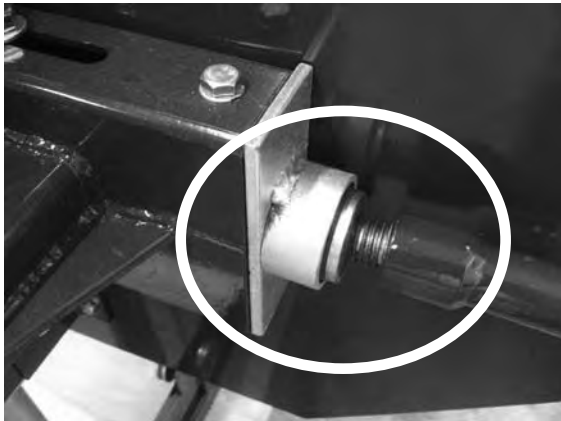

Add waterproof grease to the threads of the blade tension “T” handle and to the washer face that it meets before use. Proper blade tension is achieved when the blade deflects no more than a total of 1/8” - 1/4” up/down. Alternatively, a 24mm socket on a torque wrench may be used to tighten the “T” handle to 55 ft-lbs torque. See above right image.

****Note – It is very important to take the tension off of the blade by turning the “T” handle in the counter-clockwise direction when the sawmill is not in use. Failure to do so, will result in flat spots on the rubber belts. These flat spots will cause the mill to vibrate excessively during next use.****



Add water proof grease to all “T” handle threads on the sawmill.

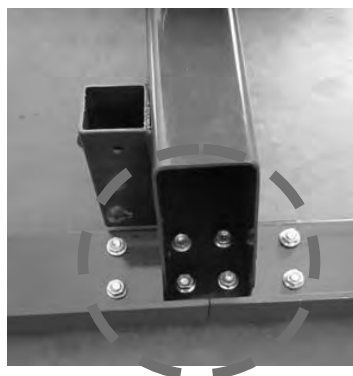
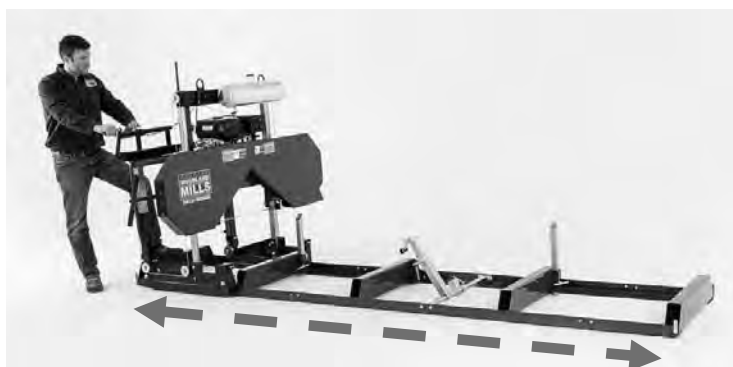

Push the saw head up and down the track system to ensure that the width of the track allows for the saw head to move freely. If it binds, the “L” rails will need to be set further or closer together to achieve a consistent width along the entire track system. Once the desired width is achieved, all nuts and bolts can be tightened to the log bunks as shown in above right image using a 16mm socket.

#5 – ENGINE



Refer to the engine manual before using your sawmill. Please note that the engine does not contain any gasoline or engine oil when it is shipped. Furthermore, the engine is equipped with an oil alert system, meaning that if the crankcase oil level is low or empty, the power is cut to the spark plug and it will not start.

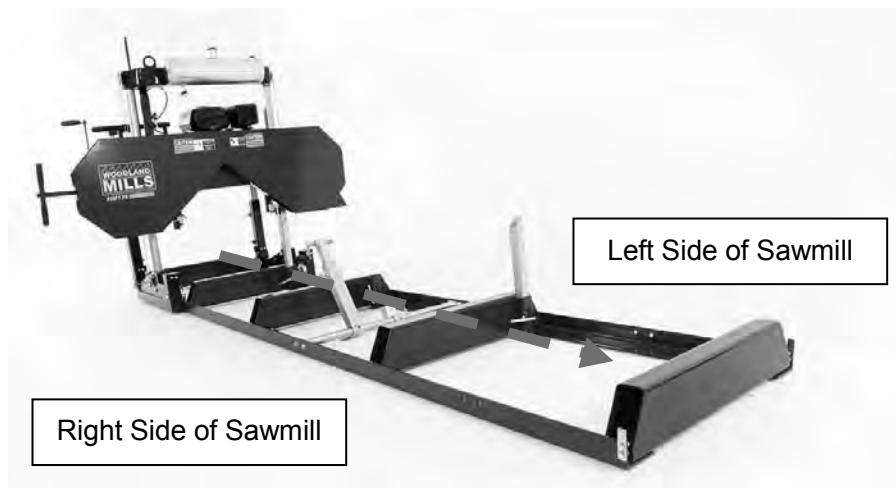

Always cut in the direction shown above. The log clamp should always be on the right side of the log and the log supports should always be on the left. Failure to cut in this direction can cause the log to come loose and possibly even cause damage or injury.

****Now that your sawmill is assembled, please run through the “SAWMILL SET-UP PROCEDURES” in the following section. Failure to do so may result in poor sawing performance, damage or injury. See next page.****

SAWMILL SET-UP PROCEDURES

#1 – BELT TENSION



To check the belt tension, with your hand, firmly try to deflect the belt up and down. There should be no more than 1/4" of deflection in both directions (1/2" total). If the belt deflects more than this, it will need to be tightened as described below.

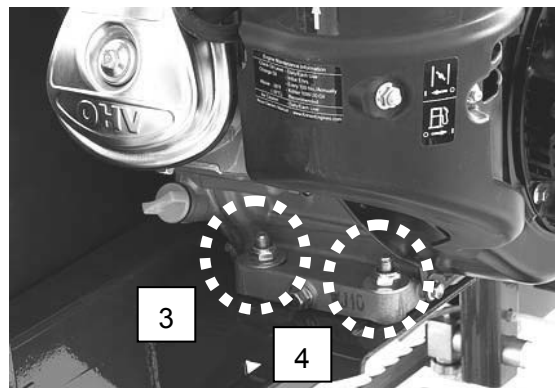
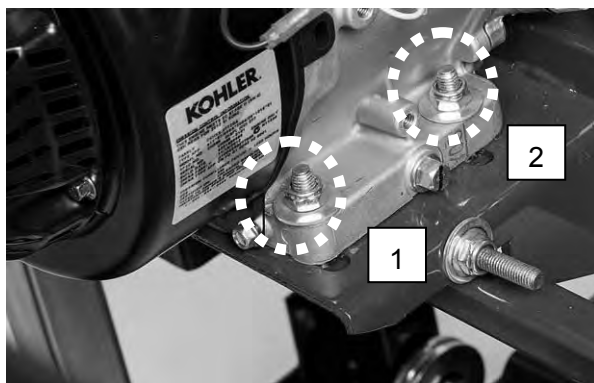

To tighten the drive belt, start by loosening the four bolts that secure the engine to the engine mount using a 16mm wrench.



Now that the engine is free to slide on the engine mounting plate, turn the 16mm nut on the horizontal stud in the clockwise direction. This will pull the engine towards the stud and apply more tension on the belt. Do this step incrementally while checking the belt for proper deflection. It is also important to ensure that the engine remains perpendicular to the drive belt. Over tightening can cause the engine to twist on the mounting plate, resulting in belt alignment issues and premature wear. Once the desired belt tension is set, tighten the four engine bolts.

Alternatively, if the drive belt is too tight, the 16mm nut on the horizontal stud can be turned counter-clockwise.

#2 – BLADE TRACKING

Never attempt the below with the engine running. As a safety precaution, remove the spark plug cap. It is also advised to wear gloves and safety glasses when working with the blade as it is extremely sharp.

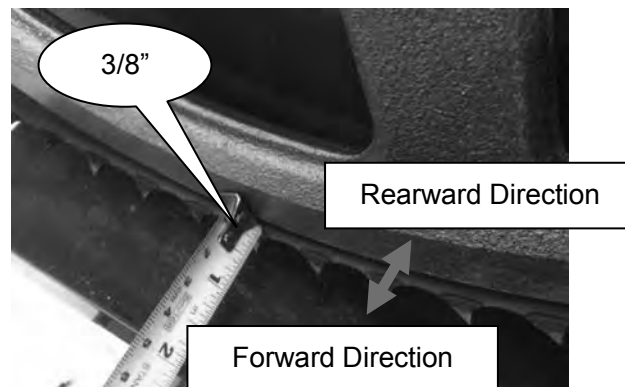
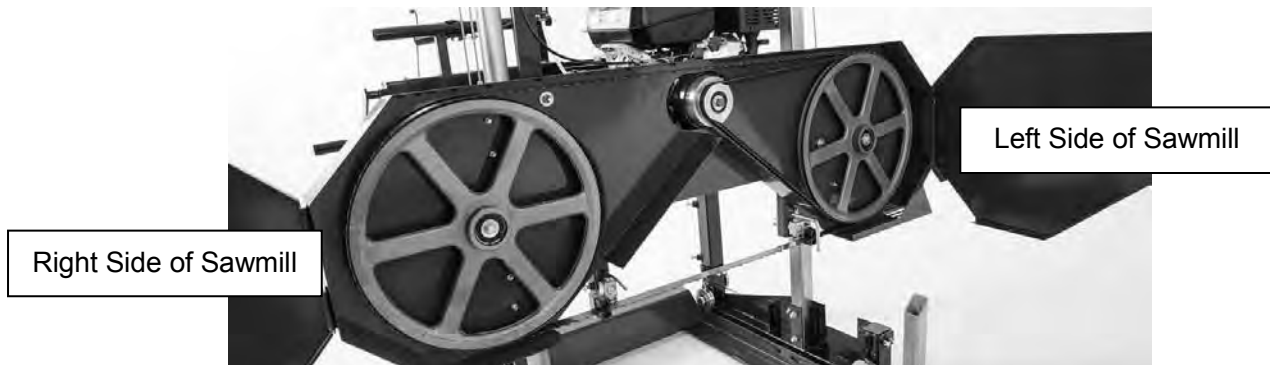

The blade should run with the same tooth to bandwheel face distance on both sides. 3/8" is ideal. Measure the distance from the tip of the blade tooth to the front face of the bandwheel on both sides. If an adjustment on either side is required, the below steps will detail this procedure.

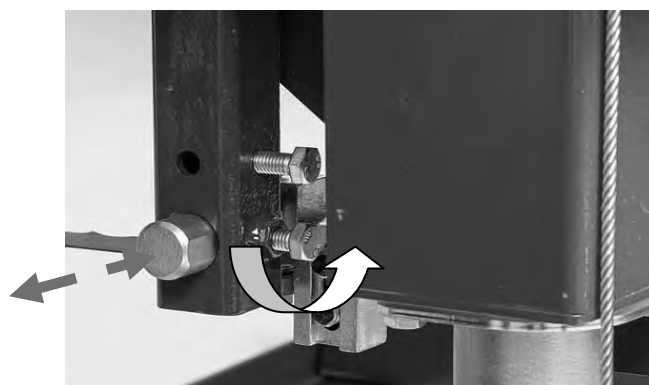

Loosen the blade guide assembly bolt with a 16mm socket. The round shaft should now be free to slide rearward and out of the way. Perform this step on both guide assemblies. This will ensure that the guide bearings do not influence tracking of the blade while adjusting.



Take some tension off of the blade by turning the “T” handle in the counter-clockwise direction one full turn from full tension position.

Adjusting The Right Hand Side

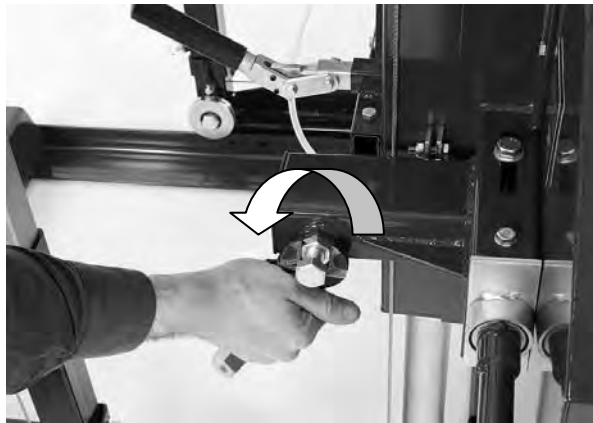

Loosen the tracking alignment locking nut with an adjustable wrench.

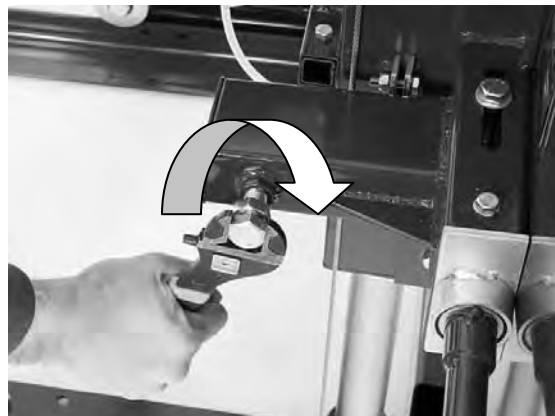

The alignment bolt can now be turned to change the angle of the bandwheel and track the blade. To move the blade more rearward on the bandwheel, this bolt will need to be turned clockwise. Alternatively, turning the bolt in the counter-clockwise direction would force the blade to run more forward on the bandwheel. Turn the bolt a 1/2 turn and re-tension the blade.

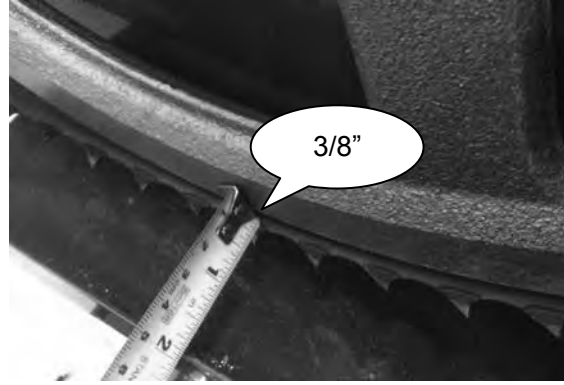

Wearing gloves, spin the bandwheel with your hand and observe how the blade has changed tracking. Measure the distance again and repeat the above step to further compensate if required. The ideal measurement is 3/8".

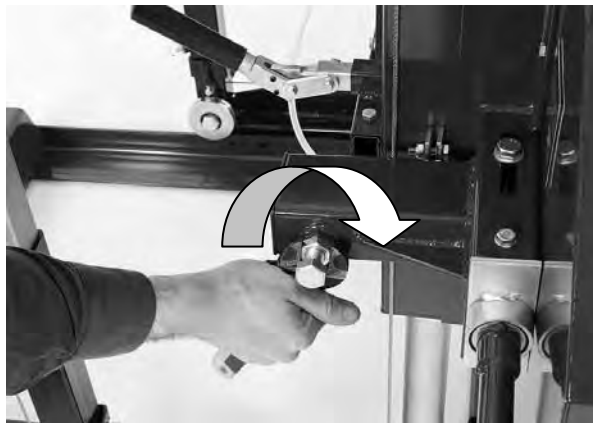

Once satisfied with the measurement, tighten the locking nut clockwise.

Adjusting The Left Hand Side

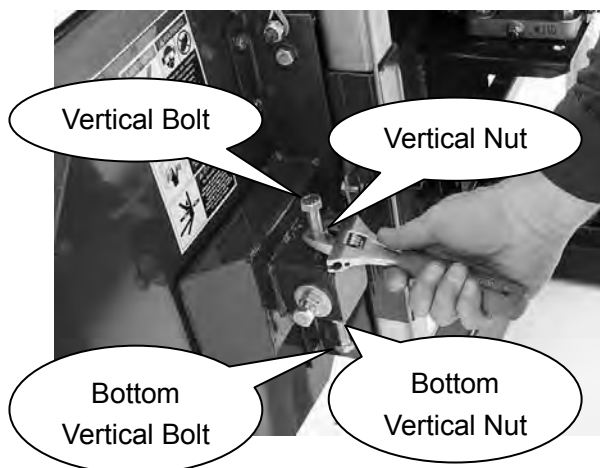

To adjust the left side of the sawmill, again start by taking the tension off of the blade by turning the "T" handle one turn in the counter-clockwise direction. Using a 16mm wrench, loosen the "**vertical nut**" a 1/2 turn. Do the same on the "**bottom vertical nut**". Next, loosen both "**vertical bolts**" a 1/2 turn. This will take the clamping force off of the bandwheel shaft caused by these two bolts and allow it to move freely in the following steps.



Moving The Blade Forward

Using a 16mm wrench, hold the **“horizontal bolt”** stationary with a wrench and turn the **“horizontal inside nut”** counter-clockwise a ½ turn. Still holding the **“horizontal bolt”** stationary, turn the **“horizontal outside nut”** clockwise a ½ turn. This has now shifted the **“horizontal bolt”** and bandwheel shaft, causing the blade to track more forward.

Moving The Blade Rearward

Using a 16mm wrench, hold the **“horizontal bolt”** stationary with a wrench and turn the **“horizontal outside nut”** counter-clockwise a ½ turn. Still holding the **“horizontal bolt”** stationary, turn the **“horizontal inside nut”** clockwise a ½ turn. This step has now shifted the **“horizontal bolt”** and bandwheel shaft, causing the blade to track more forward.

Tighten the vertical bolts, then nuts to clamp the bandwheel shaft back into vertical position.

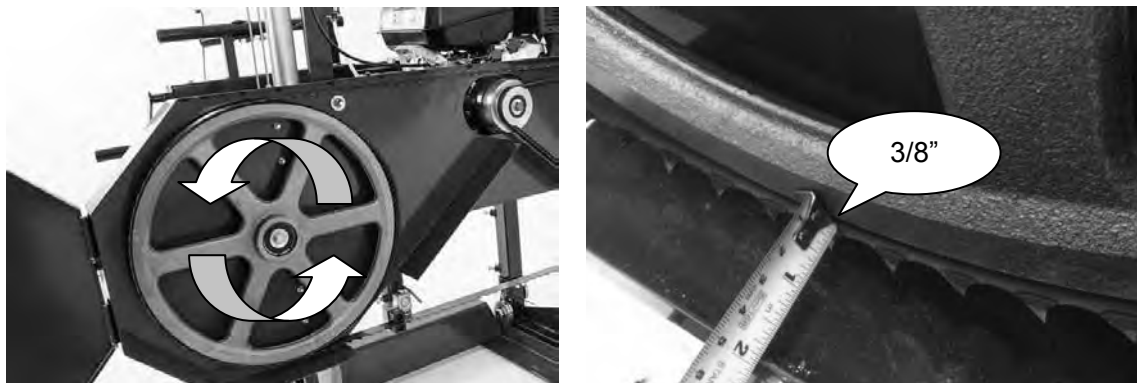

Re-tension the blade by turning the “T” handle a full turn in the clockwise direction. Wearing gloves, spin the bandwheel with your hand and observe how the blade has changed tracking. Measure the distance again and repeat the above step to further compensate if required. The ideal measurement is 3/8”.

Once the blade is tracking true, bring the blade guide assemblies back up to the blade. Keep a paper width distance between the blade guide bearing and the back of the blade. More information on this set up can be found in the next section – **“BLADE GUIDE ADJUSTMENT”**

#3 – BLADE GUIDE ADJUSTMENT

Never attempt the below with the engine running. As a safety precaution, remove the spark plug cap. It is also advised to confirm that the blade is tracking properly before performing the below. Blade tracking is covered in the previous page.



Using a 6mm allen key, loosen the blade guide blocks on both the left and right sides. They should be free to slide up and down.

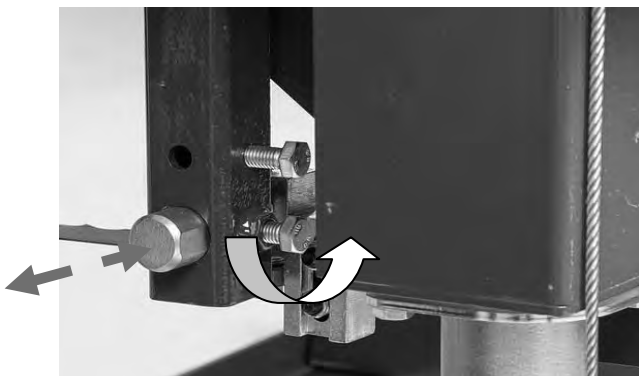

Loosen the blade guide assembly bolt with a 16mm socket. The round shaft should now be free to slide back and forth. Position it so that there is a paper width gap between the bearing and the back of blade. Tighten bolt against the flat on the shaft to secure assembly back in position.



Using a piece of paper in between the blade and blade guide blocks, tighten the allen key bolts.

#4 – BLADE TENSION

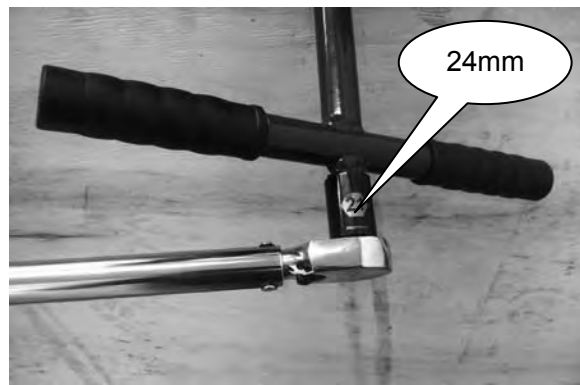

Proper blade tension is achieved when the blade deflects no more than a total of 1/8" - 1/4" up/down when it is firmly moved by hand at the center location of the blade guide blocks. Turning the blade tension "T" handle in the clockwise direction will add tension to blade. Alternatively, a 24mm socket on a torque wrench may be used to tighten the "T" handle to 55 ft-lbs torque. See above right image.

SAWMILL MAINTENANCE

#1 – CHANGING THE BLADE

Never attempt the below with the engine running. As a safety precaution, remove the spark plug cap. Gloves and safety glasses must be worn when changing the blade.

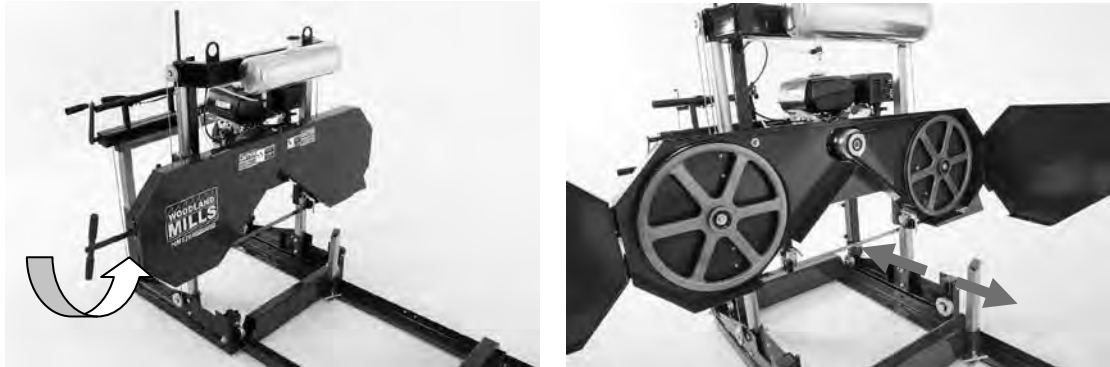

Remove the tension in the blade by turning the “T” handle in the counter-clockwise direction and then open the blade guard cover. The blade should now be loose and free to pull straight out the front. The new blade can now be installed, guards closed and proper blade tension set.

#2 – REPLACING BELTS

Never attempt the below with the engine running. As a safety precaution, remove the spark plug cap. Gloves and safety glasses must be worn when replacing the belts.

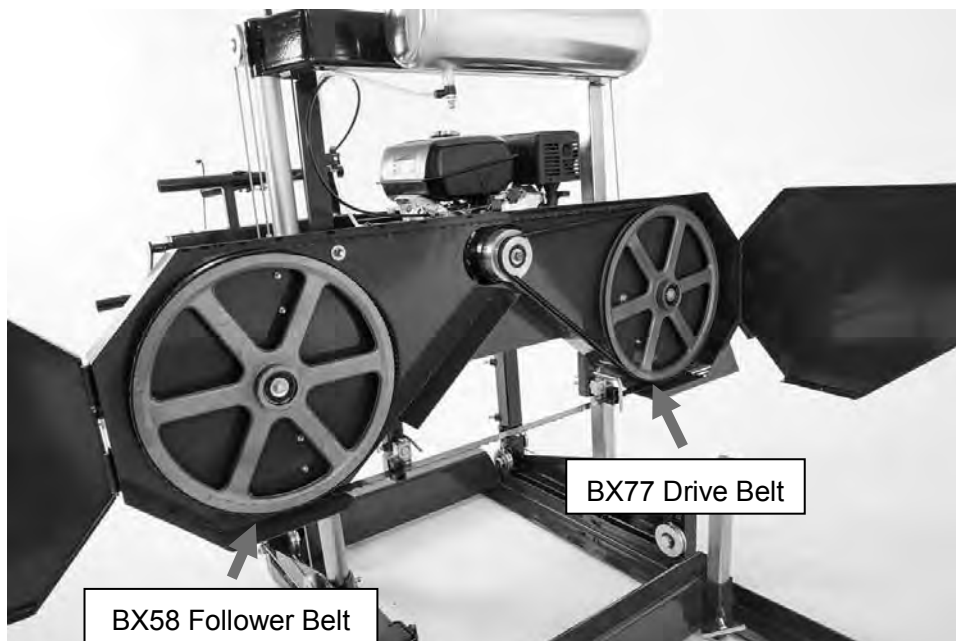

There are two rubber “V” belts on the sawmill and they should be replaced as a set. It is not advised to replace individual belts separately. It is recommended to use a BX77 cogged belt for the drive side and a BX58 follower belt.

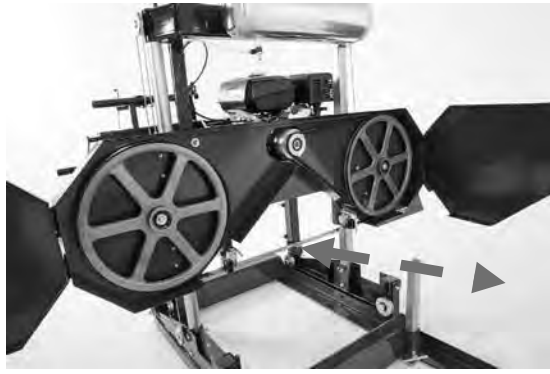
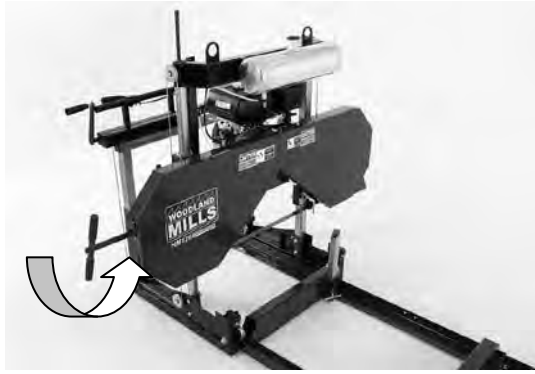

Remove the tension in the blade by turning the “T” handle in the counter-clockwise direction and then open the blade guard cover. The blade should now be loose and free to pull straight out the front.

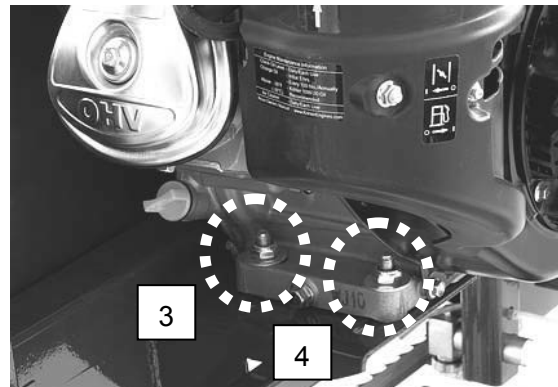
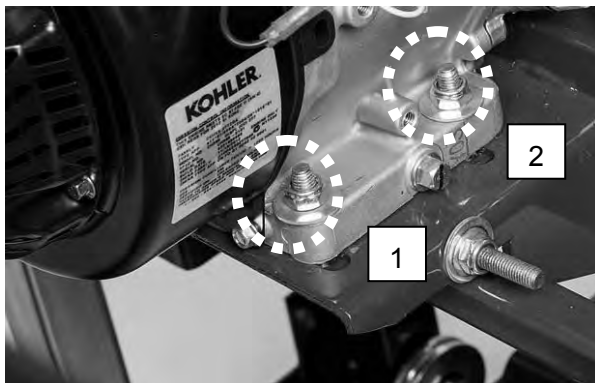

To change the drive side belt, loosen the four bolts that secure the engine to the engine mount using a 16mm wrench.

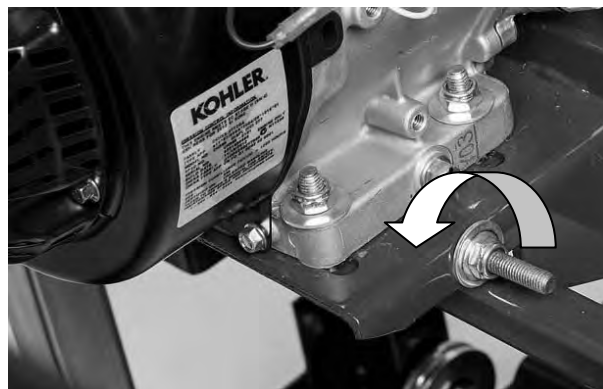

Now that the engine is free to slide on the engine mounting plate, turn the 16mm nut on the horizontal stud in the counter-clockwise direction. This will allow the engine to move and will also take the tension off of the belt. The old belt can be removed and the new belt can be installed. Tension the new belt and refer to the **BELT TENSION** instructions described in the sawmill set up section of the manual.

The follower belt can now be changed by simply pulling it off and installing the new one. The blade can now be re-installed, guards closed and proper blade tension set.

Note that blade tracking is likely to change and need adjusting when new belts are installed. Refer to “BLADE TRACKING” for more information.

TROUBLESHOOTING

Problem/Issue	Possible Causes	Resolution Options
Producing wavy cuts.	<ol style="list-style-type: none"> 1. Inadequate blade tension. 2. Improper blade guide set up. 3. Improper blade tracking. 4. Sap build up on blade. 5. Dull blade. 6. Pushing mill too quickly. 	<ol style="list-style-type: none"> 1. Tighten blade. Refer to page 32. 2. Gap between guide blocks and blade are incorrect. Refer to page 31. 3. Adjust blade tracking. Refer to page 27. 4. Install new blade. Refer to page 33. Always use blade lubricant. 5. Install new blade. Refer to page 33. 6. Slow feed rate down and push head slower through log.
Last board is tapered or narrow in middle.	<ol style="list-style-type: none"> 1. Tracks are not level. 	<ol style="list-style-type: none"> 1. Tracks need to be checked with level and adjusted to be square. They also need to be set up on firm, sturdy ground/base so deflection does not occur from logs or sawmill head.
Blade dulls quickly.	<ol style="list-style-type: none"> 1. Logs are not clean. 2. Foreign objects in log. 	<ol style="list-style-type: none"> 1. Logs may contain dirt/sand causing them to wear prematurely. 2. Tree may contain nails, staples, old fencing etc.
Blade comes off of bandwheels.	<ol style="list-style-type: none"> 1. Inadequate blade tension. 2. Improper blade guide set up. 3. Improper blade tracking. 4. Belts are worn. 5. Dull blade. 6. Pushing mill too quickly. 	<ol style="list-style-type: none"> 1. Tighten blade. Refer to page 32. 2. Gap between guide blocks and blade are incorrect. Refer to page 31. 3. Adjust blade tracking. Refer to page 27. 4. Install new belts. Refer to page 33. 5. Install new blade. Refer to page 33. 6. Slow feed rate down and push head slower through log.
Blades are breaking.	<ol style="list-style-type: none"> 1. Too many blade sharpenings. 2. Inadequate blade tension. 3. Improper blade guide set up. 4. Improper blade tracking. 5. Pushing mill too quickly. 	<ol style="list-style-type: none"> 1. Replace blade. Refer to page 33. 2. Binding between guide blocks when blade is too loose. Tighten blade. Refer to page 32. 3. Gap between guide blocks and blade are incorrect. Refer to page 31. 4. Adjust blade tracking. Refer to page 27. 5. Slow feed rate down and push head slower through log.
Blade is slowing down or stopping when milling.	<ol style="list-style-type: none"> 1. Inadequate blade tension. 2. Improper drive belt tension. 3. Pushing mill too quickly. 	<ol style="list-style-type: none"> 1. Tighten blade. Refer to page 32. 2. Belts are worn or too loose. Replace. Refer to page 33. 3. Slow feed rate down and push head slower through log.
Mill is not cutting/cutting very slowly.	<ol style="list-style-type: none"> 1. Dull blade. 2. Blade is on backwards. 	<ol style="list-style-type: none"> 1. Install new blade. Refer to page 33. 2. Remove blade and flip it inside out. The teeth should be facing in the direction of the log supports.
Mill is vibrating excessively.	<ol style="list-style-type: none"> 1. Log is not clamped securely. 2. Belts are deformed. 3. Bandwheel bearing issue. 4. Pushing mill too quickly. 5. Loose bolts. 	<ol style="list-style-type: none"> 1. Ensure log is clamped firmly resting on log bunks and against log supports. 2. Belts may have flats in them from leaving blade tension tight when not in use. Replace them. Refer to page 33. 3. Inspect and replace the bandwheel bearings if worn. 4. Slow feed rate down when milling. 5. Check all bolts to ensure they are tight.

DIAGRAM & PARTS LIST

P/N	Description	Spec	Q'ty
1	Track Wheel		4
2	Hex Nut	M20	4
3	Saw Head Wheel Base (Left)		1
4	Spacer Plate		1
5	Nut	M12	6
6	Hex Bolt	M20x110	4
7	Saw Head Wheel Base (Right)		1
8	Hex Bolt	M12x80	5
9	Nut	M12	6
10	Spacer Plate		1
11	Hex Bolt	M8x20	9
12	Hex Bolt	M10x25	21
13	Hex Bolt	M12x65	3
14	Blade Tension Handle		1
15	Flat Washer	12	2
16	Bolt	M12x145	1
17	Round Support Fastener Assembly		1
18	Hex Bolt	M8x16	5
19	Adjustable Clamp		1
20	Round Support		1
21	Scale Frame		1
22	Hex Bolt	M8x25	12
23	Cross Beam Assembly		1
24	Flat Washer	8	9
25	Nut	M8	36
26	Round Pin	B6x40	2
27	Cotter Pin	5x20	1
28	Thread Rod		1
29	Crank Assembly		1
30	Plastic Handle		1
31	Hex Bolt	M12x65	3
32	Hex Nut	M12	6
33	Bolt	M1X90	4
34	Housing		1
35	Pulley Wheel		5
36	Bolt	M12x25	3
37	End Circlip	12	3
38	Spring Washer	φ12	3
39	Thread Block		1
40	Hex Bolt	M12x70	1
41	Spacer	φ16X12	2
42a	Bearing	6001	11
42b	Spacer	Φ19x5	4
43	Nut	M12	1
44	Bolt	M10x30	2
45	Flat Washer		1
46	Hook		2

P/N	Description	Spec	Q'ty
47			
48	Square Post		1
49	Bolt	M12x65	2
50	Blade Guard (Back)		1
51	Bolt	M12x45	1
52	Nut	M12	4
53	Hex Bolt	M12x100	1
54	Spacer		1
55	Bolt	M8x45	6
56	Reinforcement Rail		1
57	Engine Mount Plate		1
58	Hex Bolt	M12x80	2
59	Cam Lock Handle		2
60	Bolt	M10x25	2
61	Spring Washer	10	2
62	Flat Washer	10	2
63	Circlip	62	2
64	Bandwheel Bearing	6305	4
65	Cogged Belt	BX77	1
66	Bandwheel		2
67	Clutch		1
68	Pin		1
69	Blade		1
70	Bolt	M8x45	4
71	Blade Guide Block		4
72	Blade Guide Block Holder		1
73	Round Pin		2
74	Drive Wheel Shaft		1
75	Driven Wheel Shaft		1
76	Cogged Belt	BX58	1
77	Hex Bolt	M10x25	28
78	Track A		2
79	End Stop		4
80	Horizontal Log Support (End)		2
81	Horizontal Log Support		2
82	Vertical Log Support (Long)		2
83	Mandrel Assembly		2
84	Nut	M10	32
85	Spindle Tube		1
86	Log Fastener Receiver Tube		1
87	T Bolt		5
88	Log Fastener Rocker Arm		1
89	Fastener Crank		1
90	Horizontal Log Support (Joiner)		1
91	Vertical Log Support (Short)		2
92	Track B		2
93	Nut	M8	1

DIAGRAM & PARTS LIST CONT'D

P/N	Description	Spec	Q'ty
94	Crank Plastic Handle		1
95	Sleeve	φ8.5	1
96	Flat Washer	φ8	1
97	Bolt	M8X45	1
98	Track Reinforcement Plate		2
99	Log Support		2
100			
101	Hold Block(Left)		1
102	Bolt	M8X12	2
103	Nut	M8	2
104	Ball Bearing	6200	2
105	Flat Washer	φ10	10
106	Bolt	M10X25	2
107	Sawblade pulley Guard (Right)		1
108	Sawblade pulley Guard (Left)		1
109	Wing Bolt	M8X30	1
110	Engine Bolt	7/16-20UNFX30	1
110a	Washer	φ10	1
110b	Clutch Housing Guard		1
111	Brass Nut	Tr20X4	1
112	Bolt	M6X20	4
113	Flat Washer	φ6	8
114	Spring Washer	φ6	4
115	Nut	M6	4
116	Aluminium Lub Tank	10L	1
117	ACME Thread Rod	Tr20X4	1
118	Ball Bearing	51102	2
119	Nut	M14X1.5	2
120	Water Switch A	SLS-03	1
121	Water Hose A	450mm	1
122	Water Switch B	HVFF8-8	1
123	Water Hose B	950mm	1
124	Brass Tube	φ6	1
125	Scale	24"	1
126	Scale Bracket	609mm	1
127	Handle Sleeve	φ20	2
128			
129	Wing Bolt	M8X30	1
130	Spacer Plate		1
131	Handle Sleeve	φ16	2
132	Bushing	φ20	8
133	Circlip	φ42	4

P/N	Description	Spec	Q'ty
134	Ball Bearing	6004	4
135	Pushing Handle		1
136	Log Support Assembly (Joint)		1
137	Throttle Cable		1
138	Fastener Plate		1
139	Bolt	M6X55	1
140	Nut	M6	2
141	Throttle Handle		1
142	Nut	M10	2
143	Square Support Assembly		1
144	ACME Thread Rod Receiver		1
145	Track wheel Sweeper(Left)		2
146	Nut	M8	8
147	Bolt	M8X25	8
148	Track wheel Sweeper (Right)		2
149	Lube Tank Cap		1
150	Square Post Bracing Bracket		1
151	Round Post Bracing Bracket		1
152	Bolt	M12X45	5
153	Steel Cable (Short)		1
153a	Steel Cable (Long)		1
154	Log Receiver Tube (Short)		3
155	Bolt	M6X10	4
156	Flat Washer	φ6	4
157	Scale Indicator		1
158	Indicator Bracket		1
159	Screw	ST4X7	2
160	Flat Washer	φ4	2
161	Screw	M4X35	2
162	Spring Washer	φ4	2
163	Nut	M4	2
164	Round Post end Cap		1
165	Square Post end Cap		1
166	Nylon Bushing Plate		1
167	Index Plate		1
168	Hex Bolt	M6	2
169	Crank Assembly		1
170	Index Plunger		1
171	Bolt	M10×30	8
172	End Stop		4
173	Track A		2
174	Track B		2

DIAGRAM

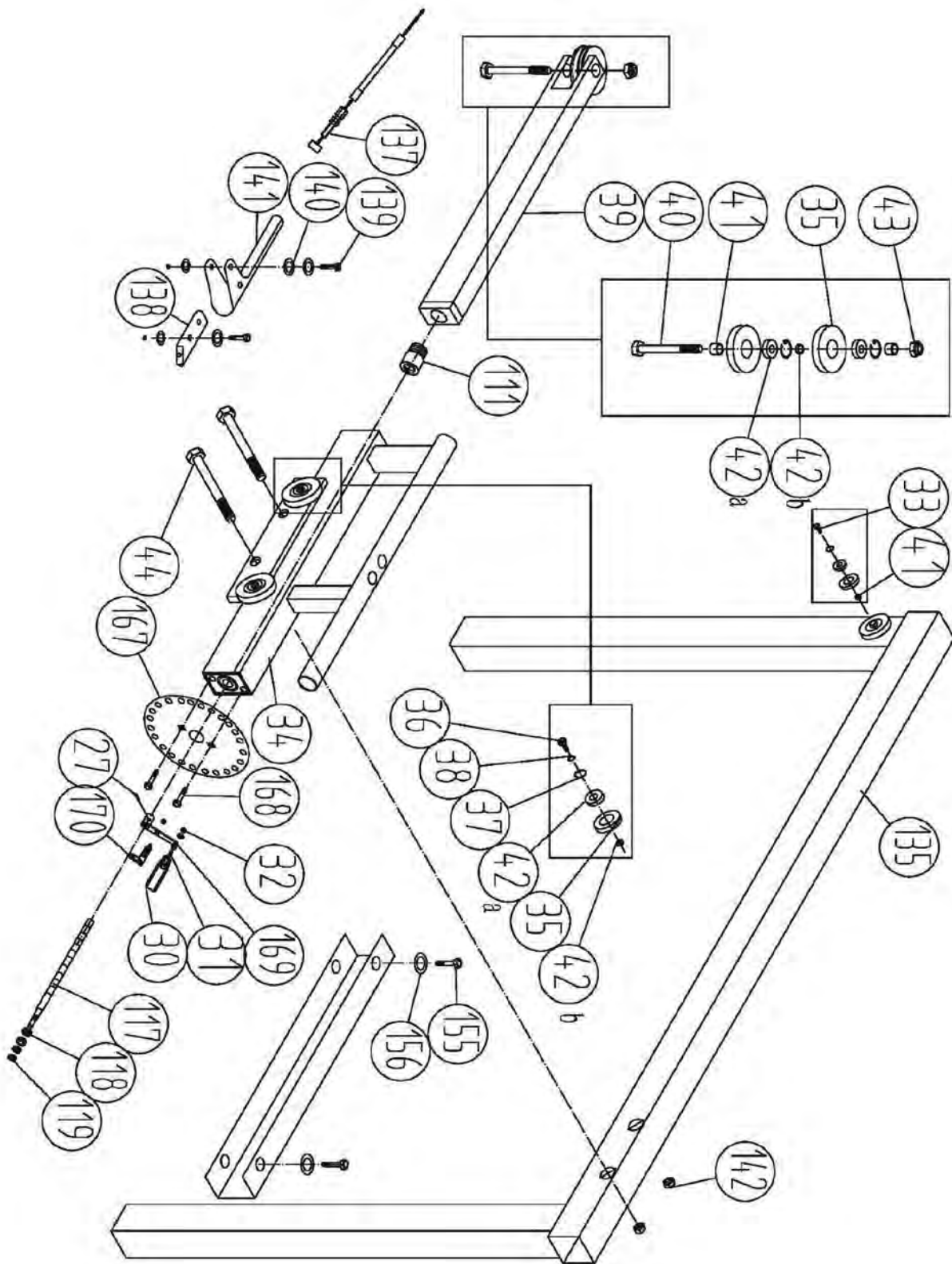

DIAGRAM

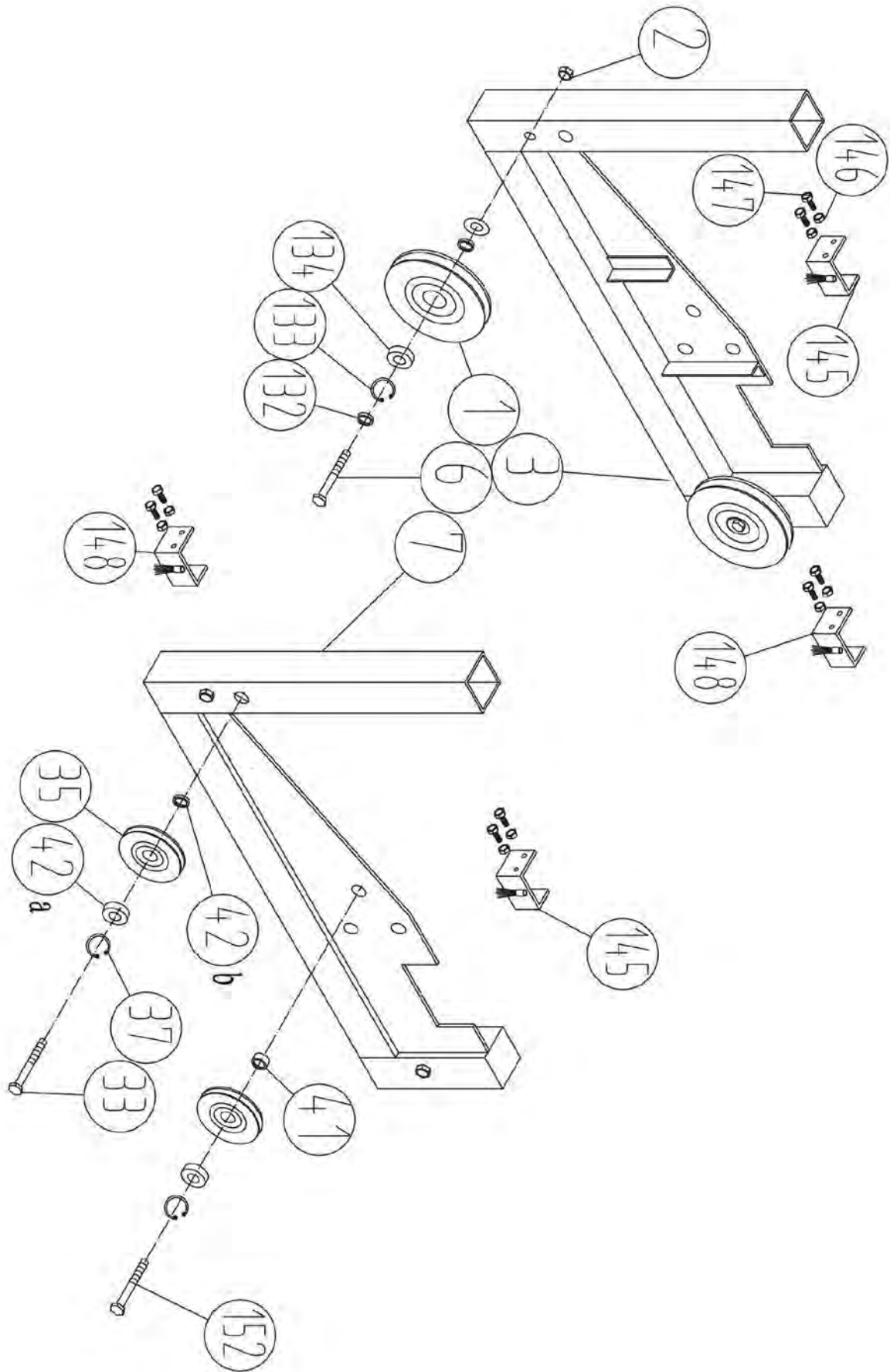

DIAGRAM

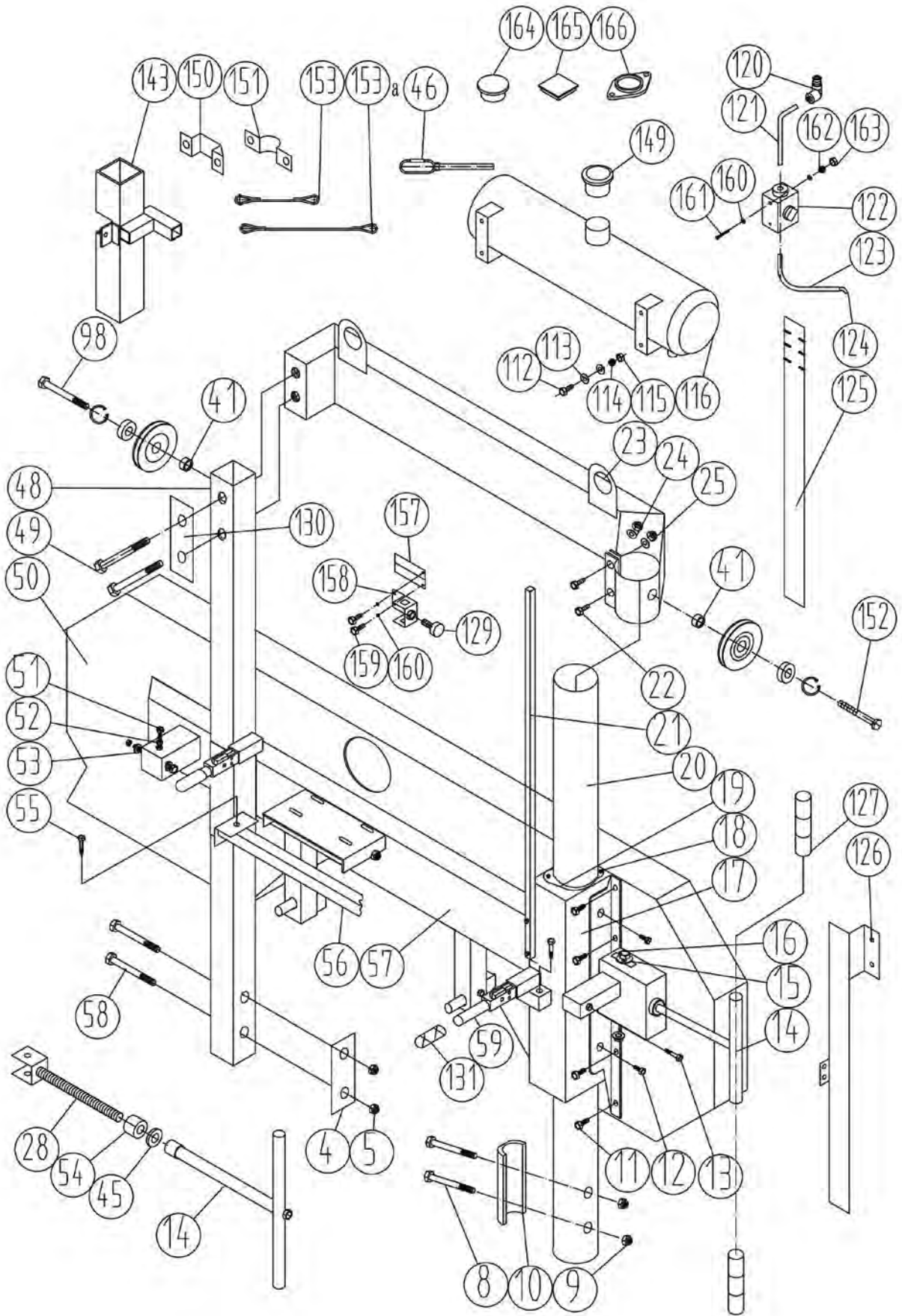

DIAGRAM

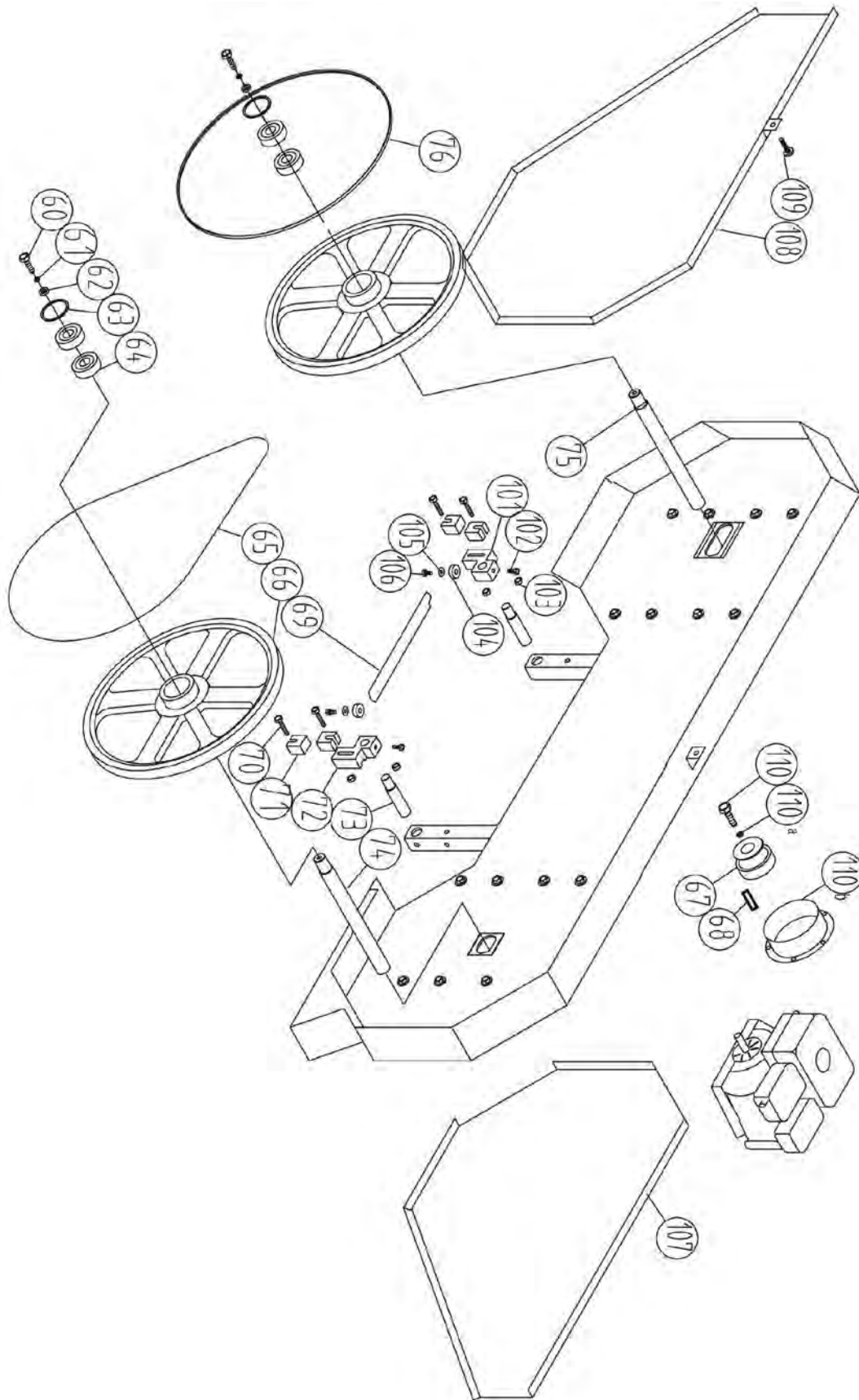

DIAGRAM

