

Warning! Choking hazard. Small parts.
 Achtung! Erstickungsgefahr. Enthält Kleinteile.
 Attention! Risque d'étouffement. Petites pièces.
 Avvertenza! Pericolo di soffocamento. Contiene parti piccole.
 Waarschuwing! Verstikkingsgevaar. Kleine deeltjes.
 Advertencia! Riesgo de asfixia. Piezas pequeñas.
 Advarsel! Kvælningsfare. Små dele.
 Varoitus! Tukehtumisvaara. Pieniä osia.
 Varning! Kvävningrisk. Innehåller smådelar.
 Atenção! Perigo de asfixia. Peças pequenas.
 Προσοχή! Κίνδυνος πνιγμού. Μικρά κομμάκια.
 警告! 窒息の危険性。小さな部品が入っていますので、ご注意ください。
 警告! 小心窒息。当心小物件。
 경고! 질식 위험. 작은 부품 포함.
 Внимание! Риск удушья. Содержит мелкие детали.

Ostrzeżenie! Zagrożenie zadławienia. Małe elementy.
 Upozornění! Nebezpečí udušení. Obsahuje malé součástky.
 Upozornenie! Nebezpečenstvo udusenja. Obsahuje malé súčasti.
 Figyelmeztetés! Fulladásveszély! Kis elemeket tartalmaz.
 Осторожно! Риск задухи. Могут быть детали.
 Upozorenje! Opasnost od gušenja. Sadrži dijelovi.
 Упозорење! Опасност од гушења. Мали делови.
 Opozorilo! Nevarnost zadušitve. Majhni delčki.
 Avertisment! Pericol de sufocare. Pieze mici.
 Внимание! Опасност от задыхане. Малки части.
 Brīdinājums! Pastāv nosmakšanas risks. Satur silkas daļas.
 Hoiatus! Lõõbumisohht. Sisaldab väikseid osi.
 Įspėjimas! Uždusimo pavojus! Komplekte yra mažų detalių.
 Dikkat! Boğulma tehlikesi. Küçük parçalar.

All copyrights, trademarks, intellectual property and other information contained belong to Brick'em Young.
 No unauthorized usage or distribution of this material (including instruction booklet) without the expressed written consent of Brick'em Young.
 Brick'em Young is not owned or affiliated with The Church of Jesus Christ of Latter-day Saints.
 Further questions can be directed to: service@brickemyoung.com.
 This brick set contains many small bricks, Parental involvement is recommended!

www.brickemyoung.com
 Product # 127:4



MADE IN CHINA

Brick'em™
 Young

Salt Lake Temple
 Beginners Set

590 Pieces
 Product# 127:4
 Ages 9+
www.brickemyoung.com

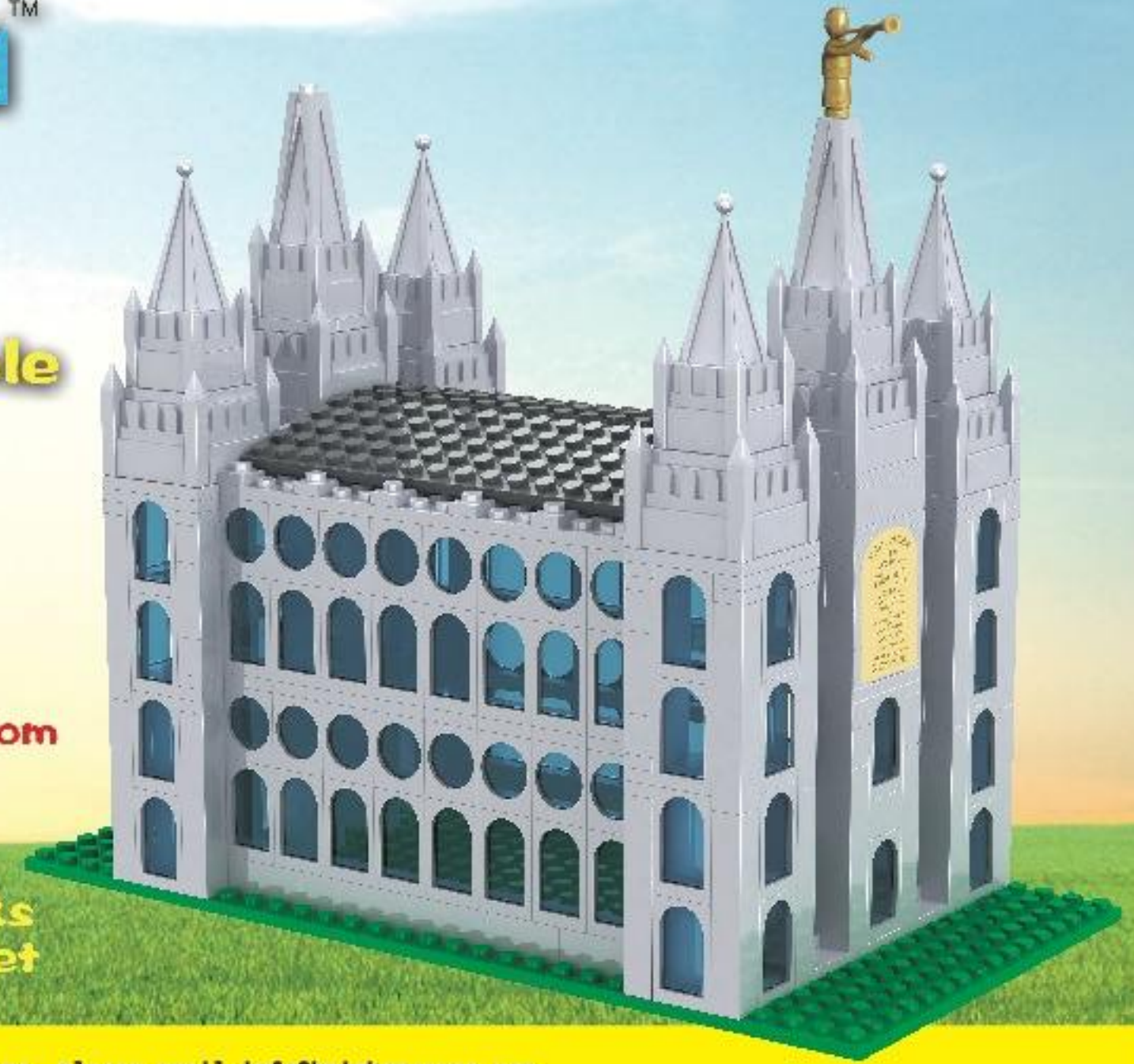

standard size bricks
 Toy Brick Building Set

www.brickemyoung.com. Any questions, please email info@brickemyoung.com

10 Interesting Facts about the Salt Lake Temple

- How long did it take the Saints to build the Salt Lake Temple?
 Answer: 40 Years! The cornerstone ceremony took place on April 6, 1853 and the temple dedication was conducted exactly 40 years later on April 6, 1893.
- Who was the President of the Church at the time of the temple ground breaking?
 Answer: Brigham Young
- Who was the President of the Church when the temple was dedicated?
 Answer: Wilford Woodruff
- What kind of stone is the Salt Lake Temple made out of?
 Answer: Granite
- Where did the granite come from?
 Answer: Little Cottonwood Canyon, roughly 20 miles from the Salt Lake Temple.
- Why did it take so long to build the temple?
 Answer: Transporting the heavy granite from Little Cottonwood Canyon to the temple site was a time consuming and difficult task. Back in those days, there were no automobiles or planes. The speed to build the temple greatly increased upon completion of the transcontinental rail system. In 1873 the first shipment of quarry was transported by rail.
- Is it true the original temple's foundation had to be replaced?
 Answer: Yes. In 1862 the temple's foundation was replaced due to cracks. The original foundation was made from firestone, which is a form of sandstone found in the mountains near the temple. The new foundation was made entirely of granite.
- Is the Salt Lake Temple the first temple to be built in Utah?
 Answer: Yes and No. It was the first to be announced in Utah; however, the Saint George, Logan and Manti temples were all completed prior to the completion of the Salt Lake Temple.
- What do the 6 towers represent? Answer: The 3 towers on the east represent the Melchizedek Priesthood and the 3 towers on the west represent the Aaronic Priesthood, as revealed to Brigham Young.
- Is the Salt Lake Temple the center of Salt Lake City? Yes! All streets in Salt Lake City are numbered from North to South and East to West with the Salt Lake Temple at the center.

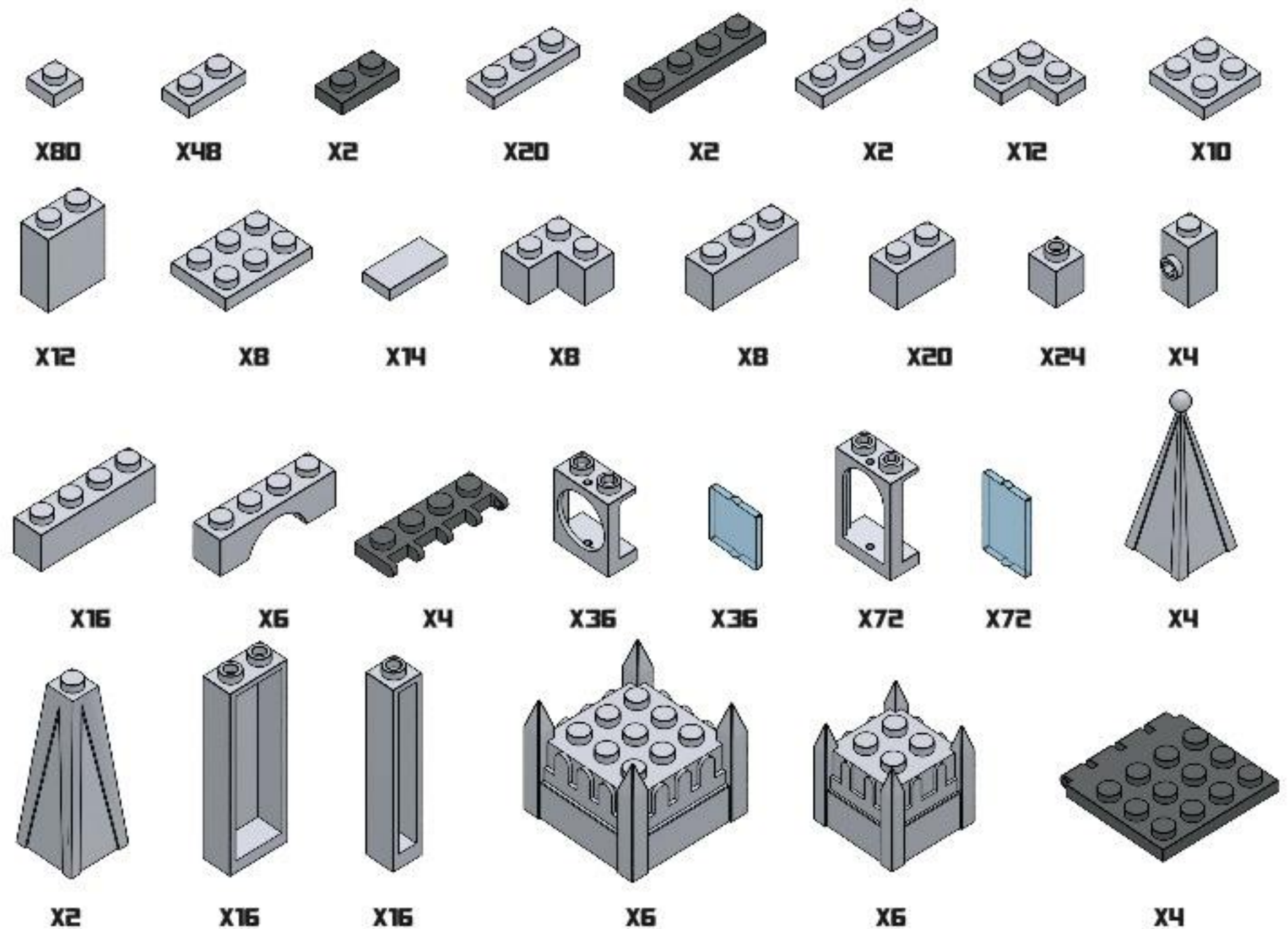

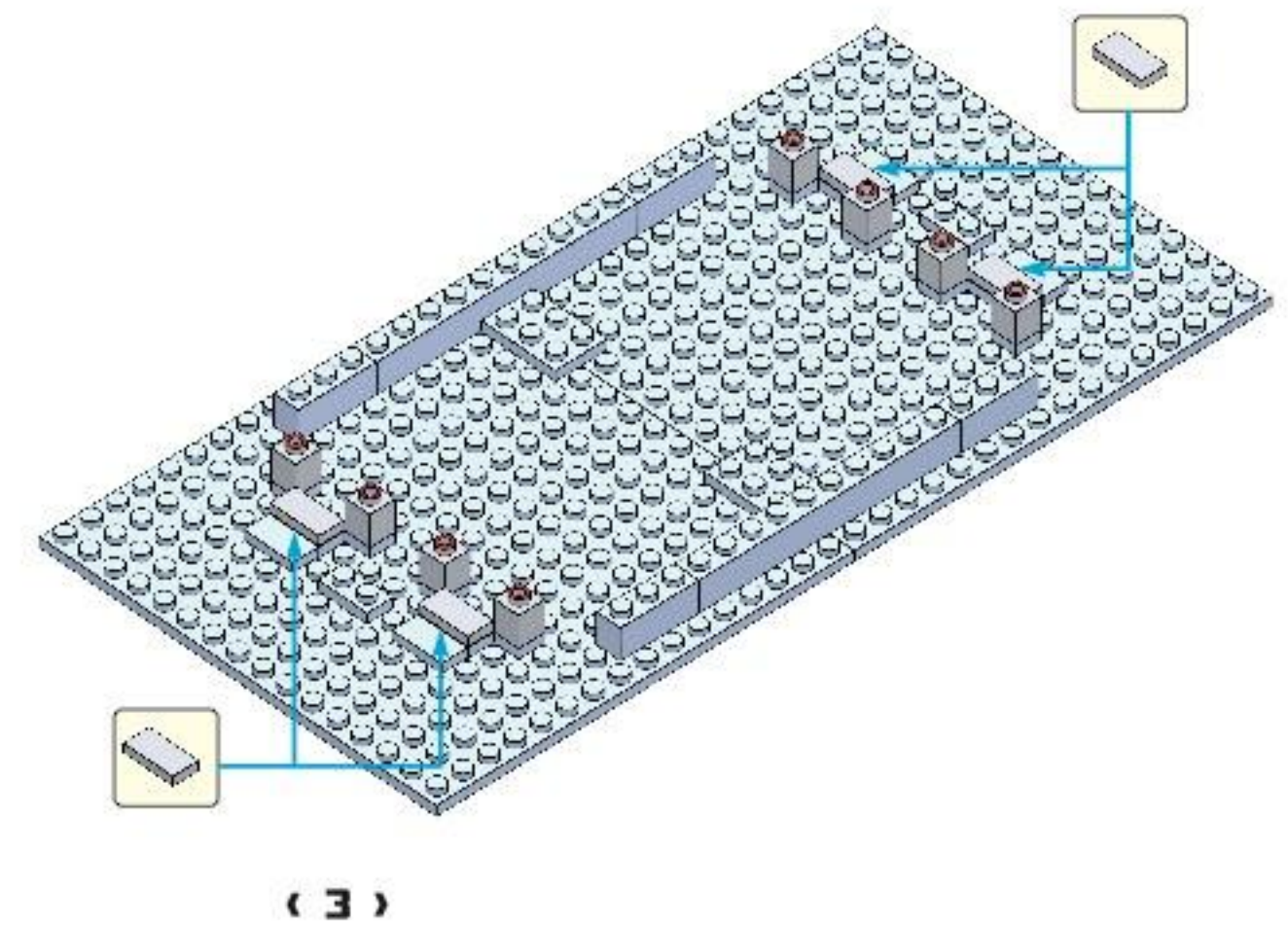
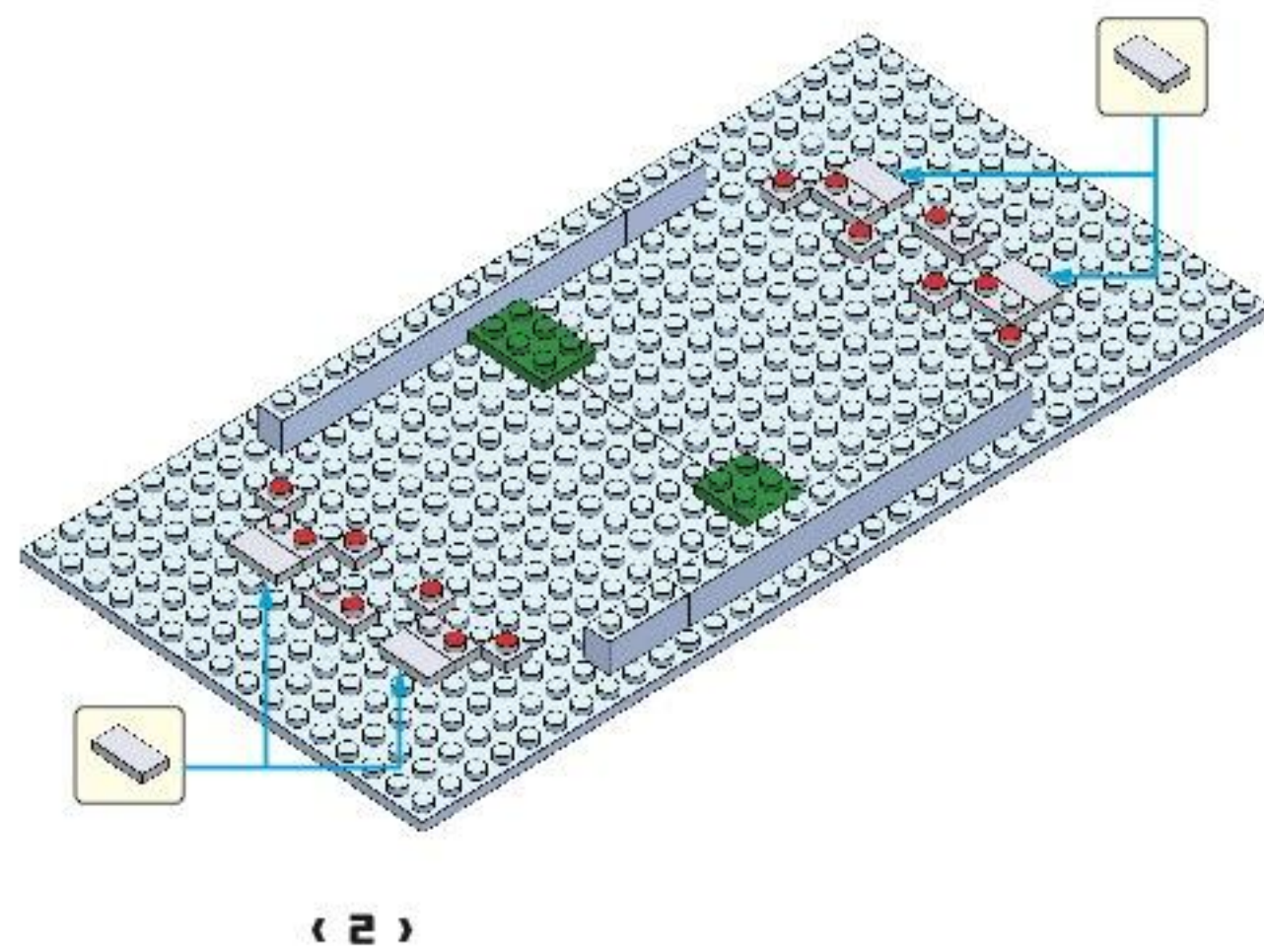
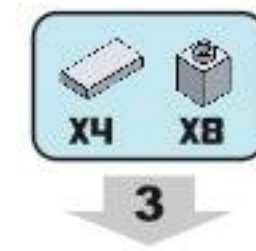
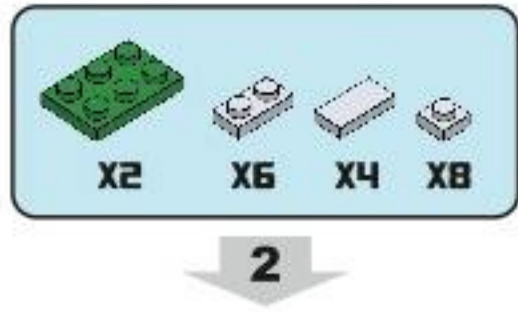
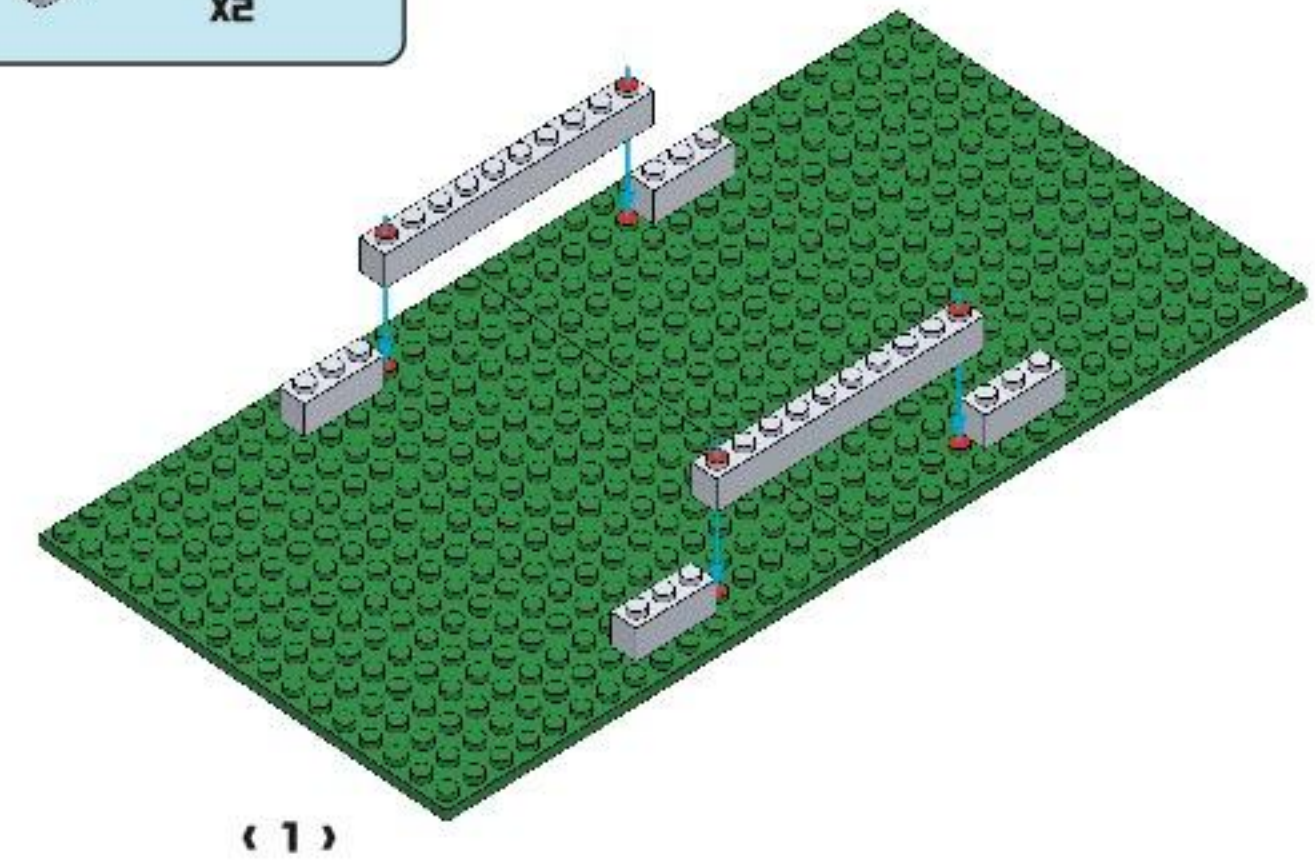
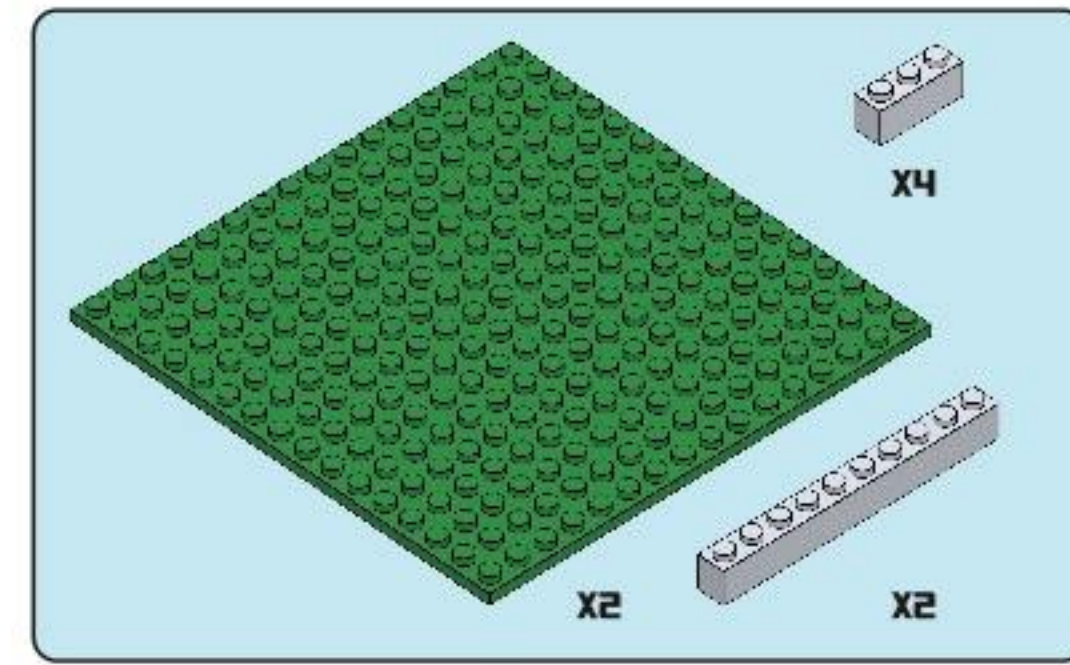
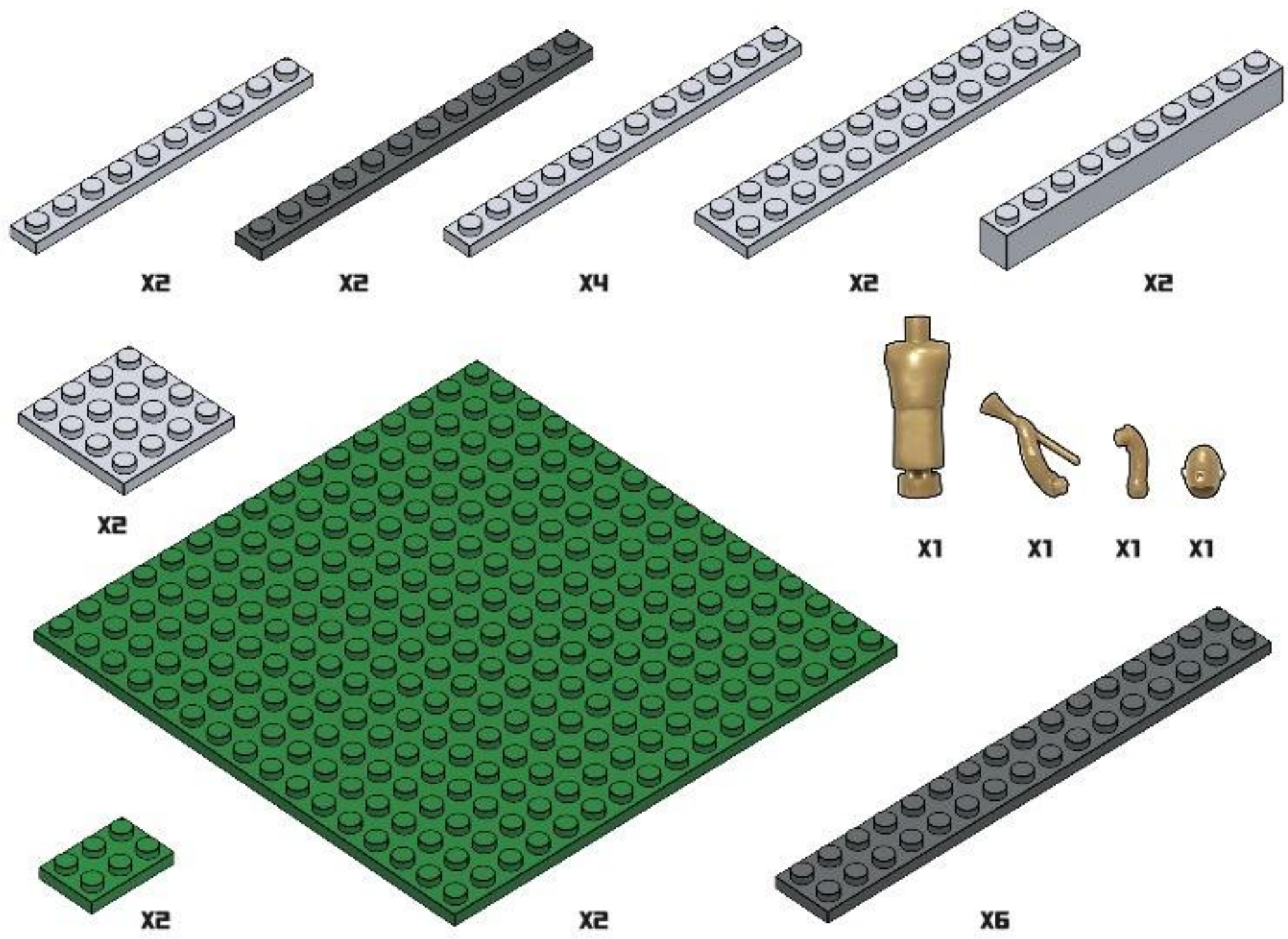

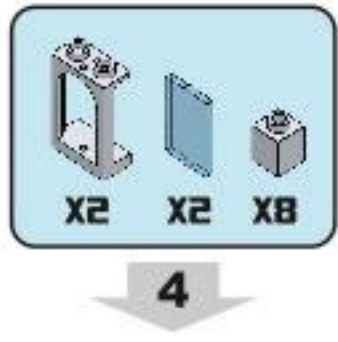

4

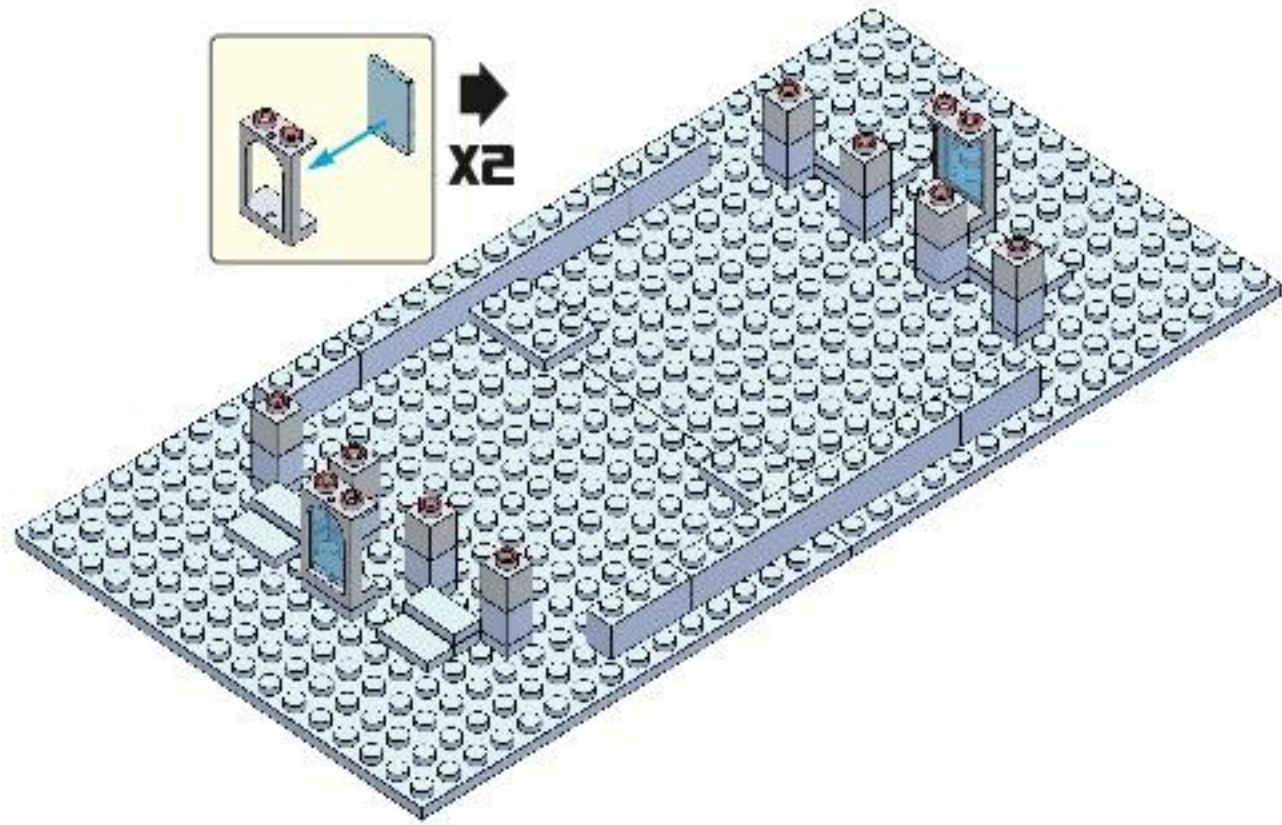

(4)

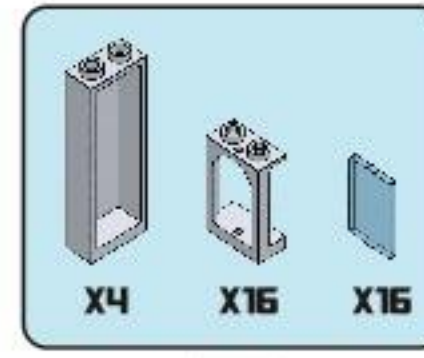

5

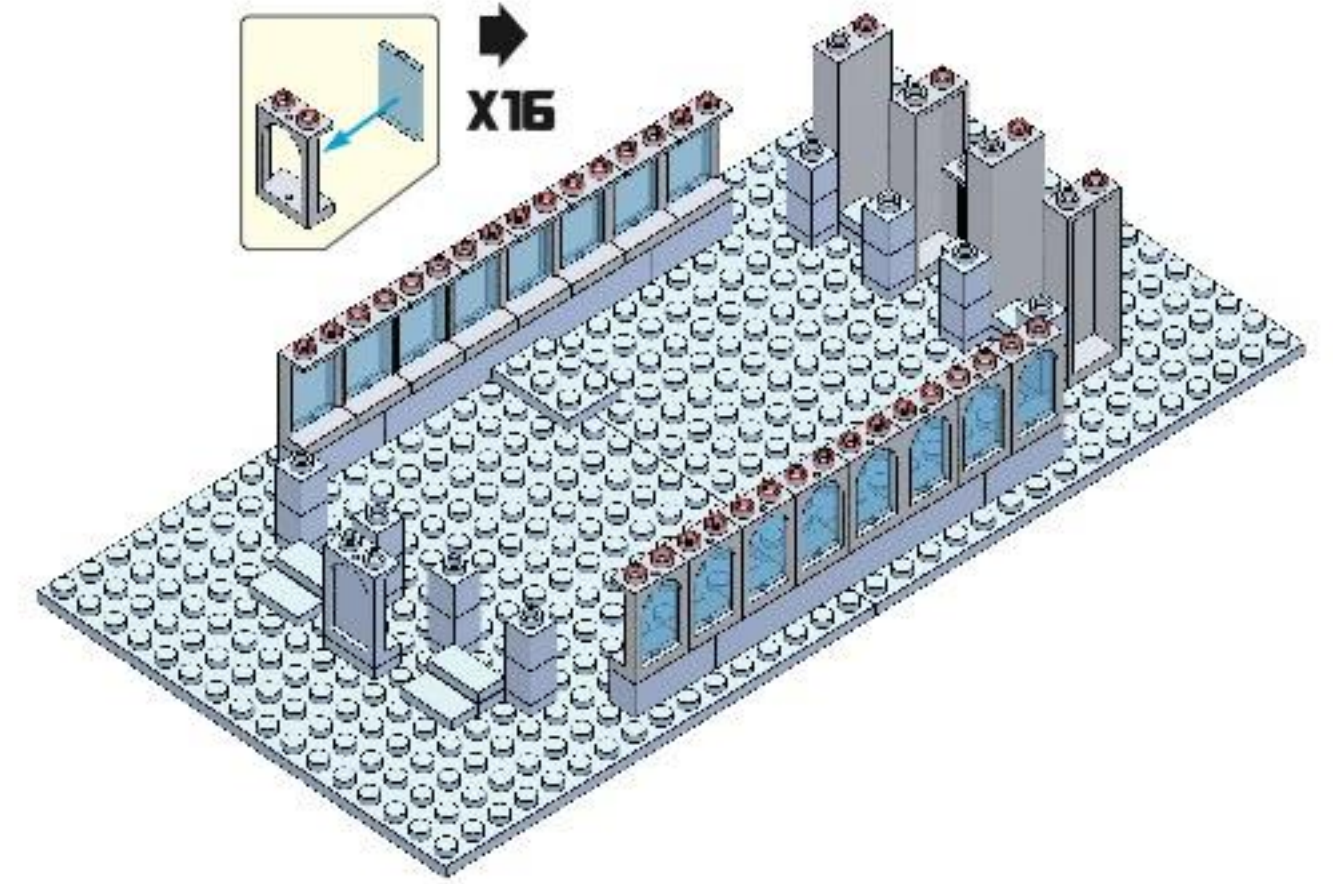

(5)

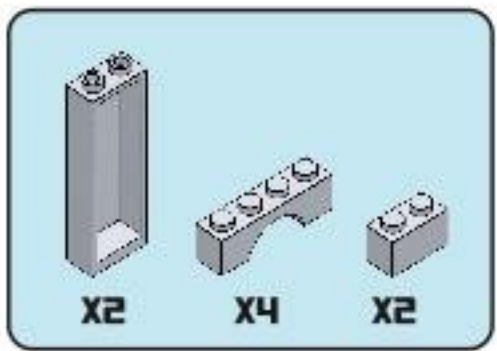

6

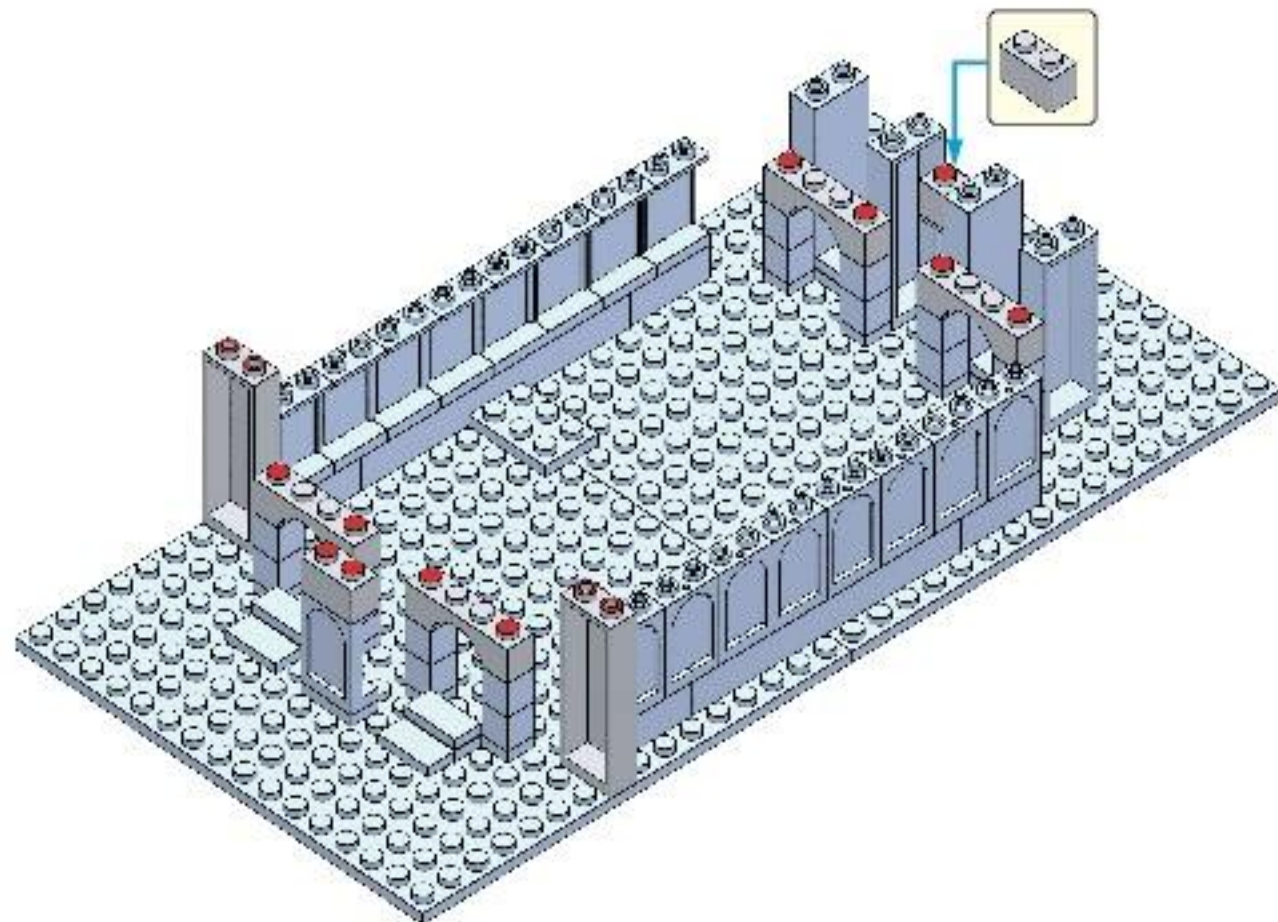

(6)

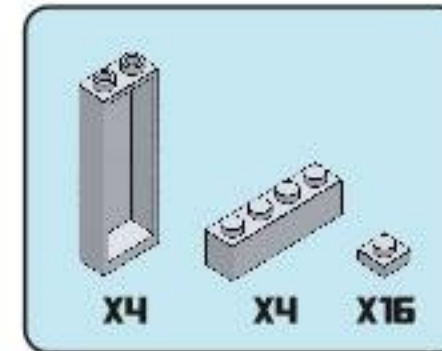

7

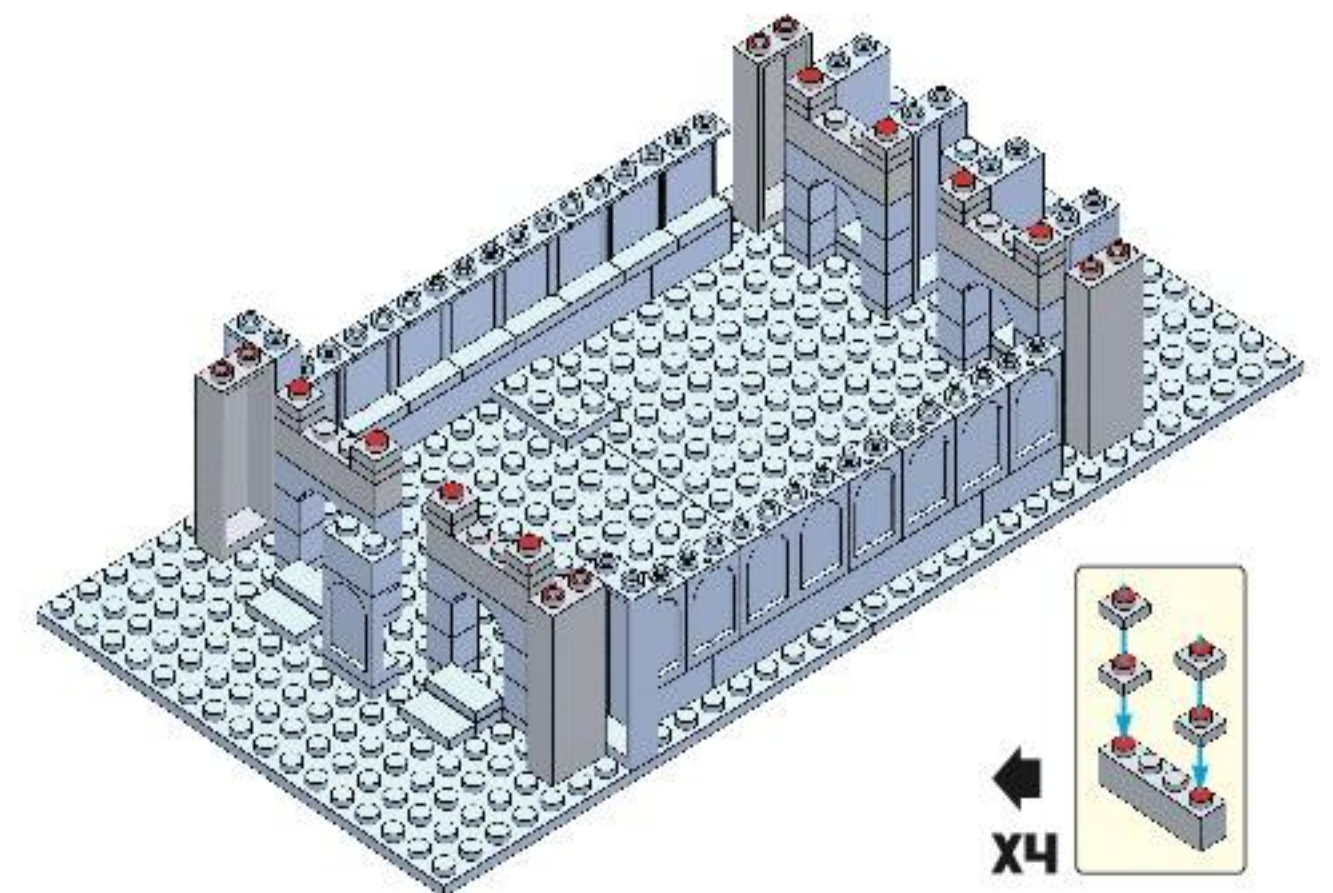

(7)

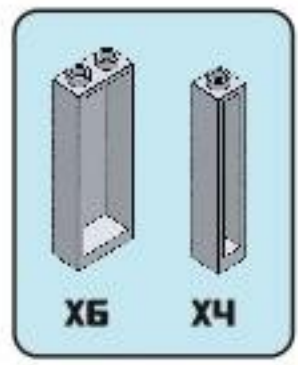

8

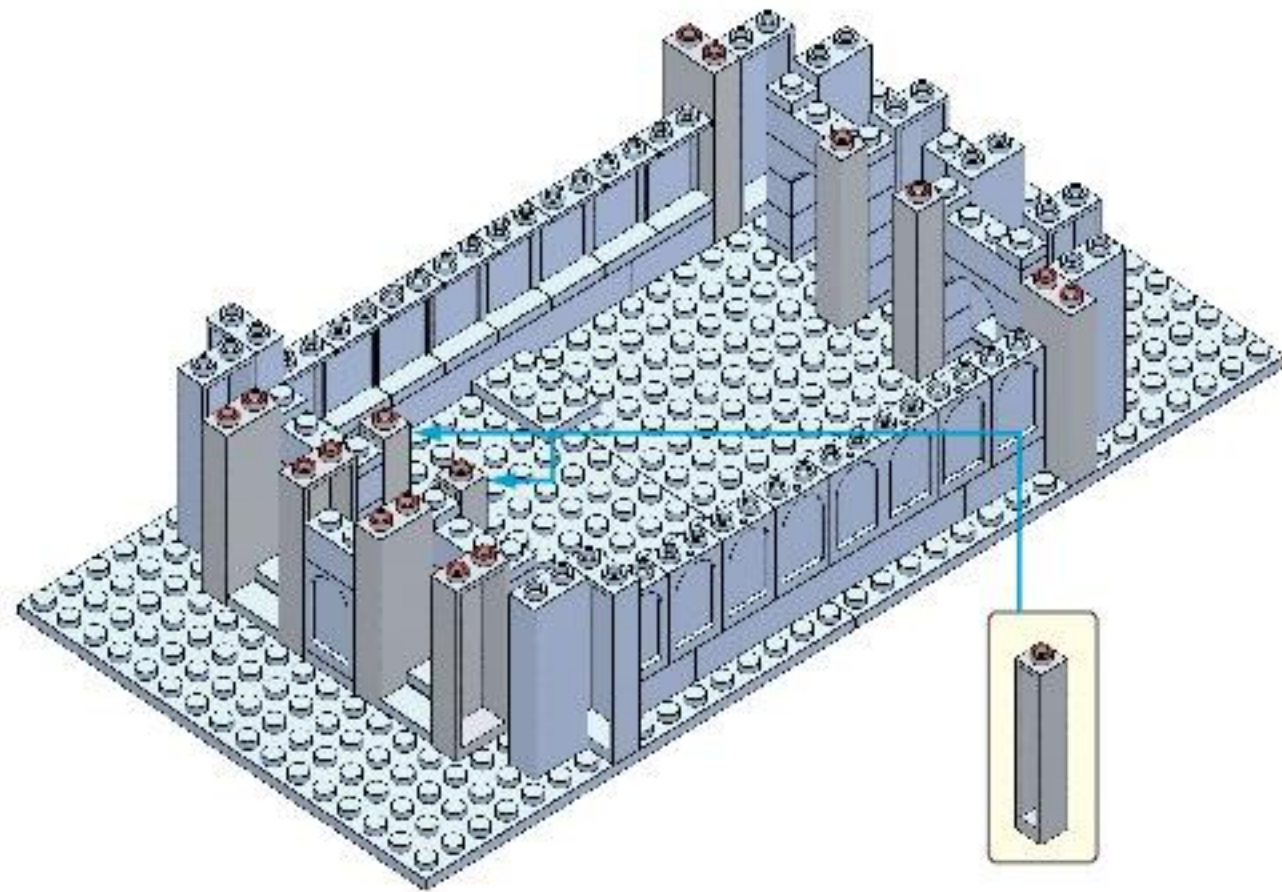

(8)

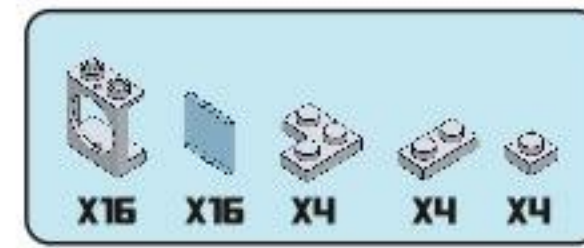

9

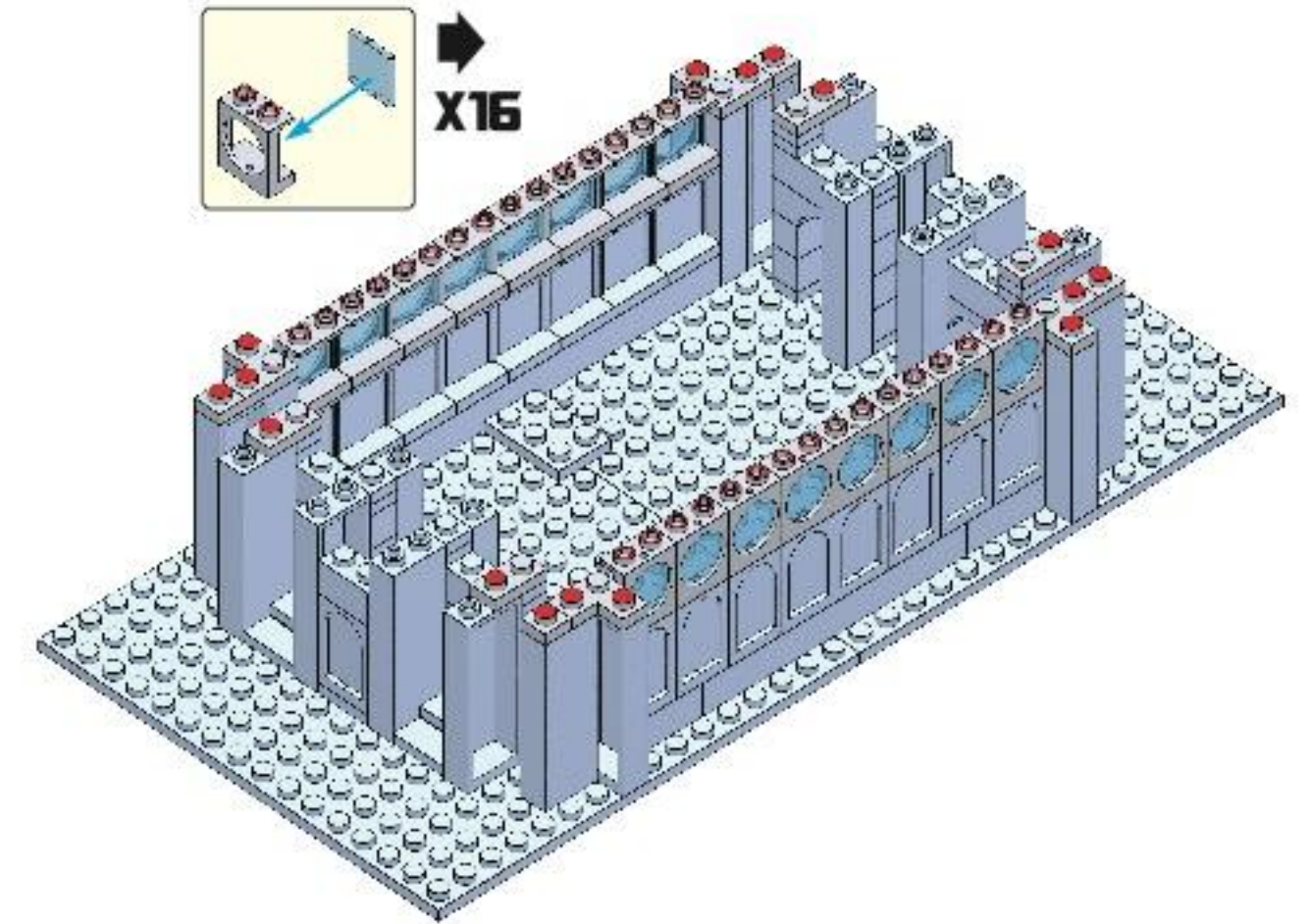

(9)

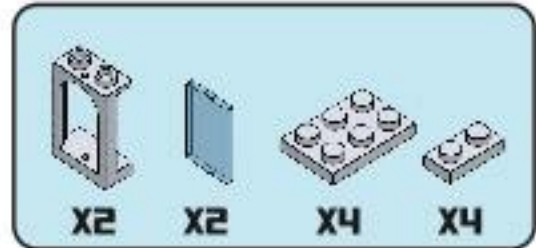

10

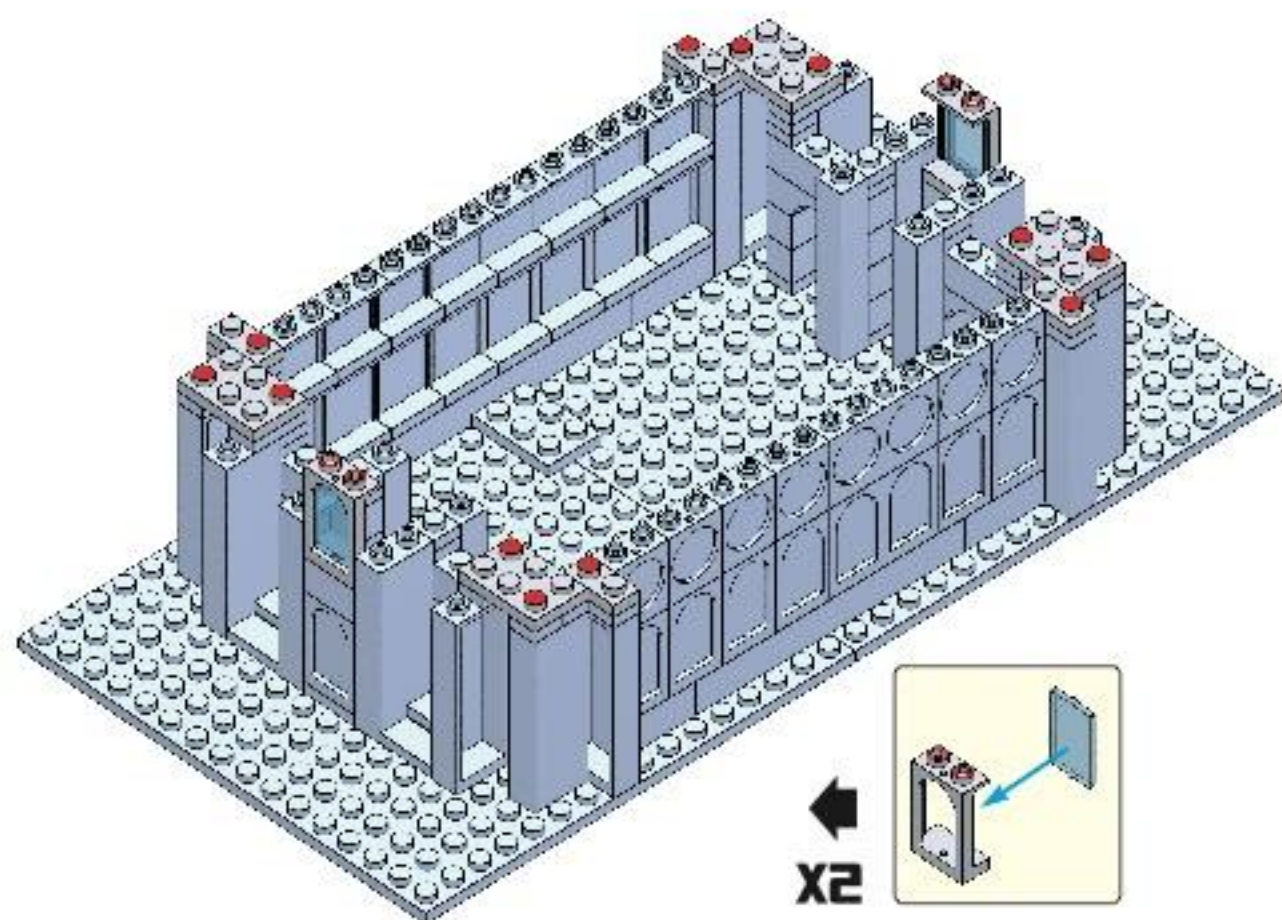

(10)

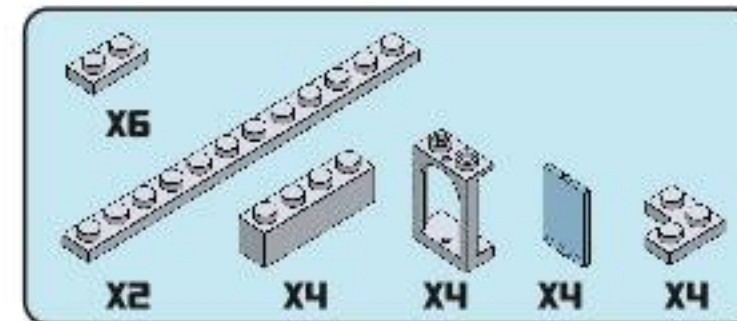

11

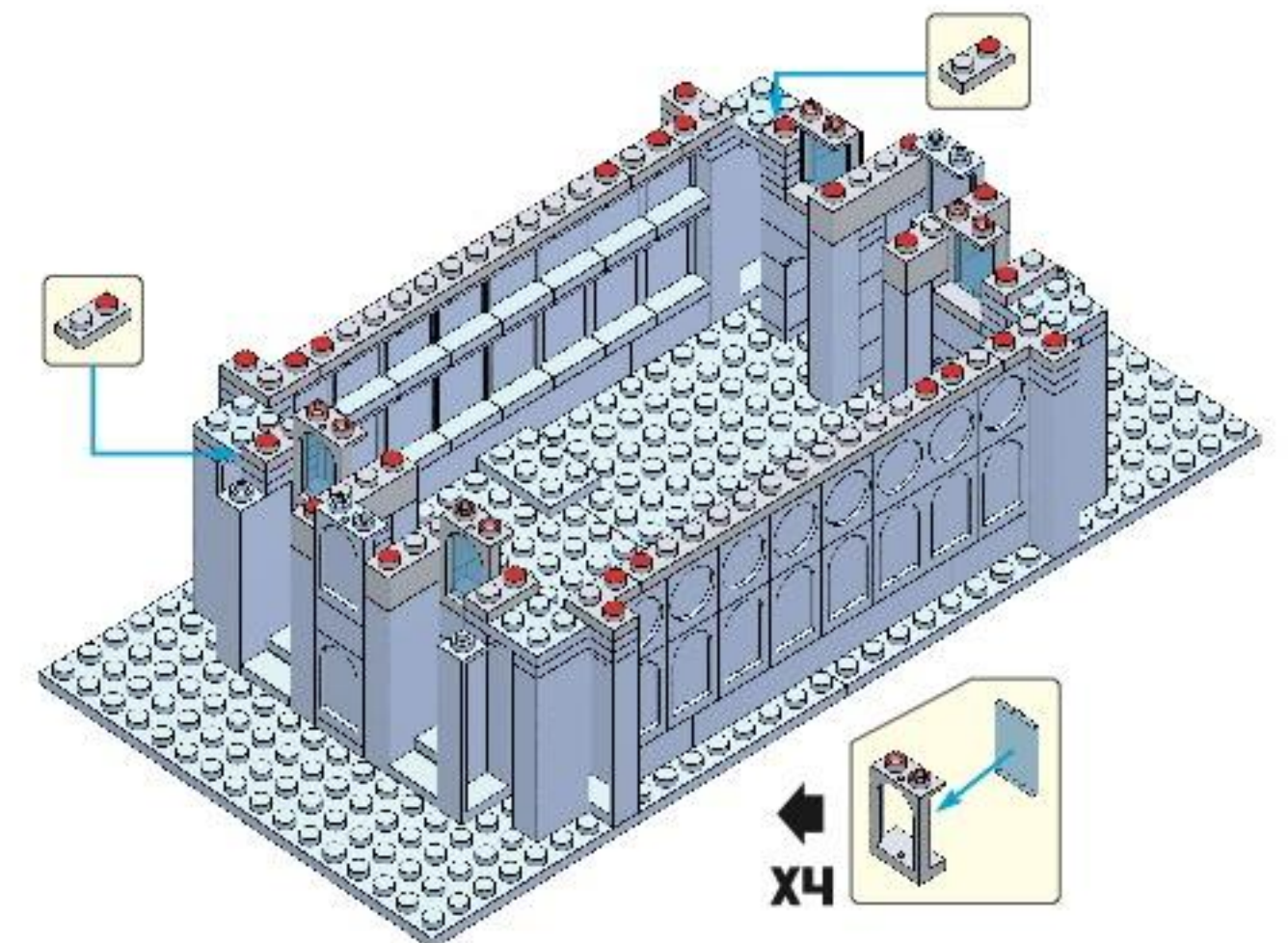

(11)



X8 X4

12

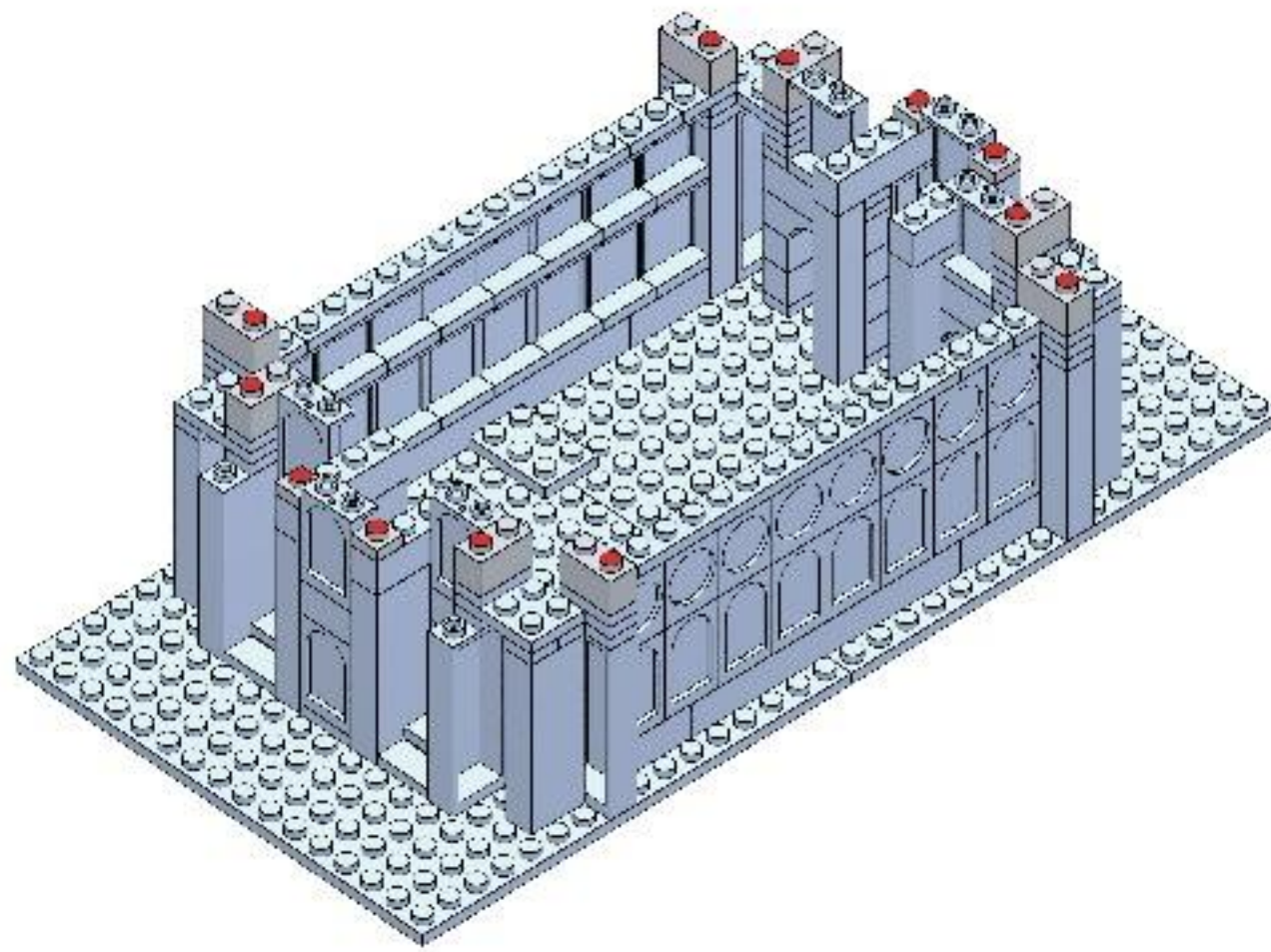

(12)



X16 X16 X2 X4 X4

13

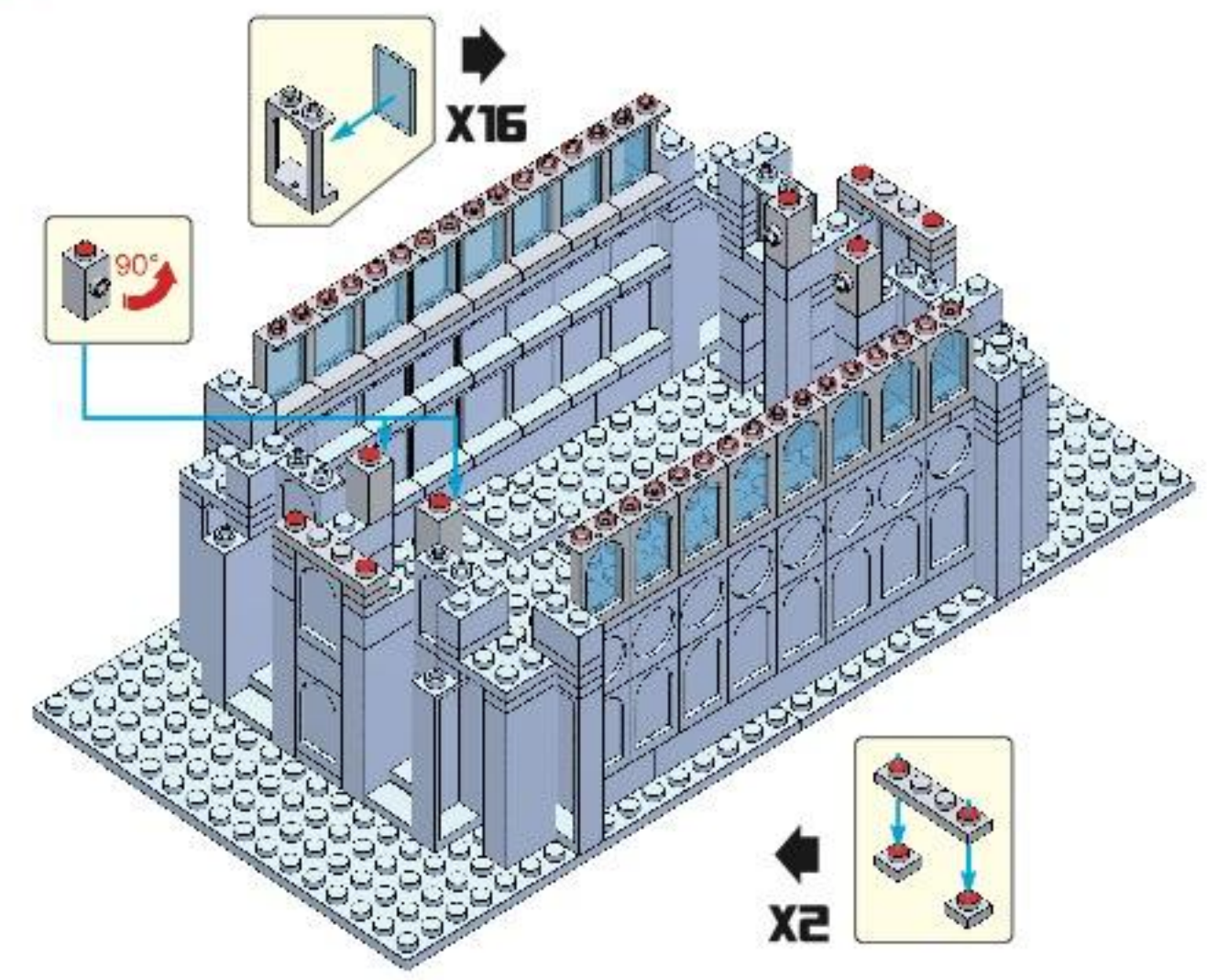

(13)

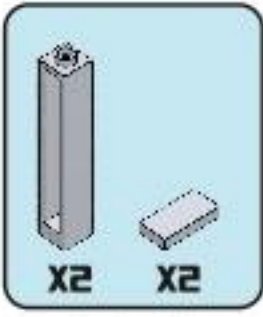

X2 X2

14

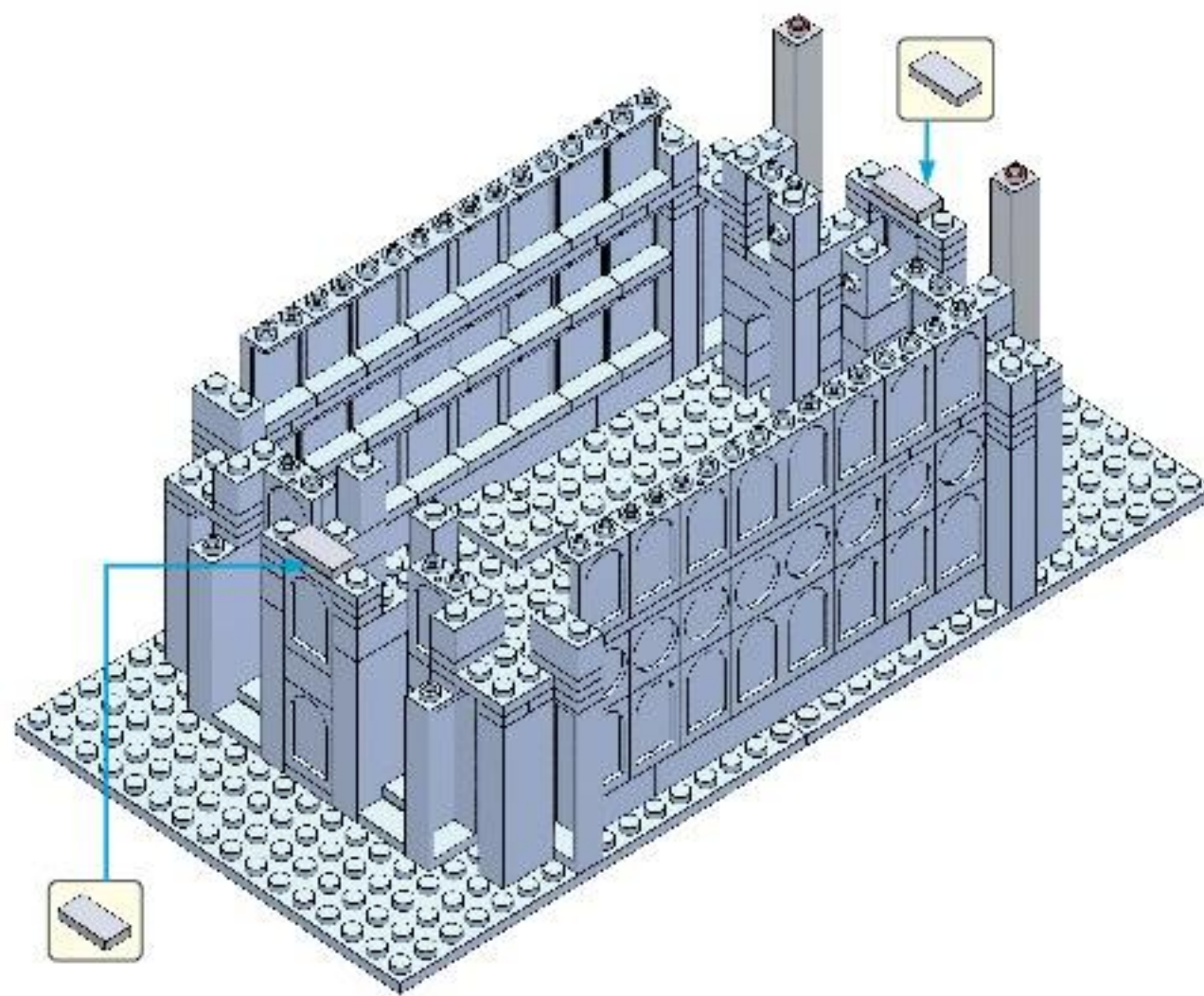

(14)

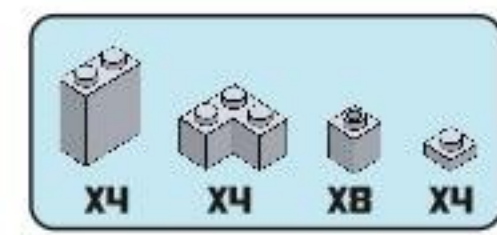

X4 X4 X8 X4

15

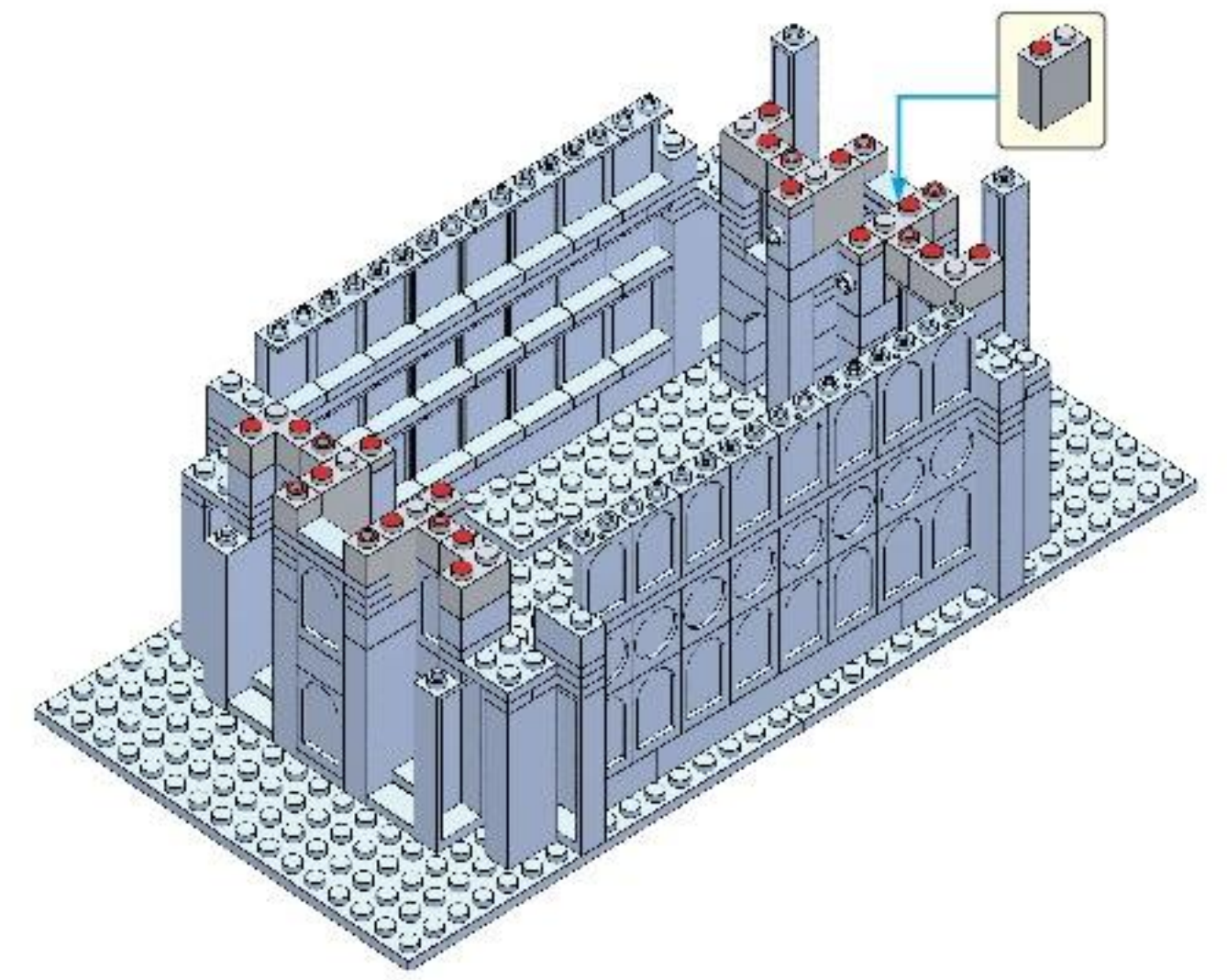

(15)

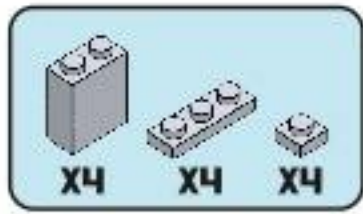

16

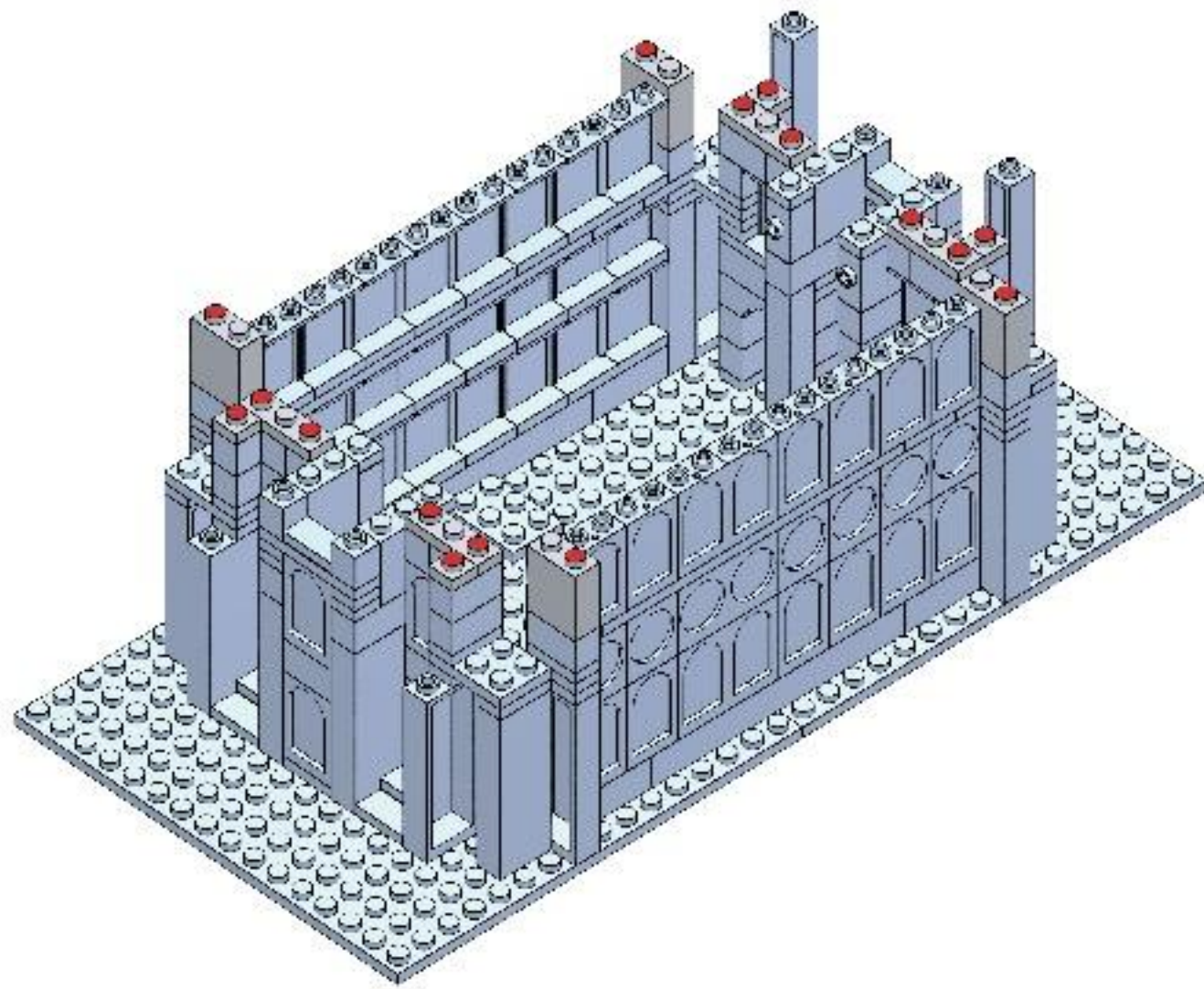

(16)

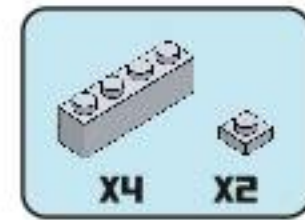

17

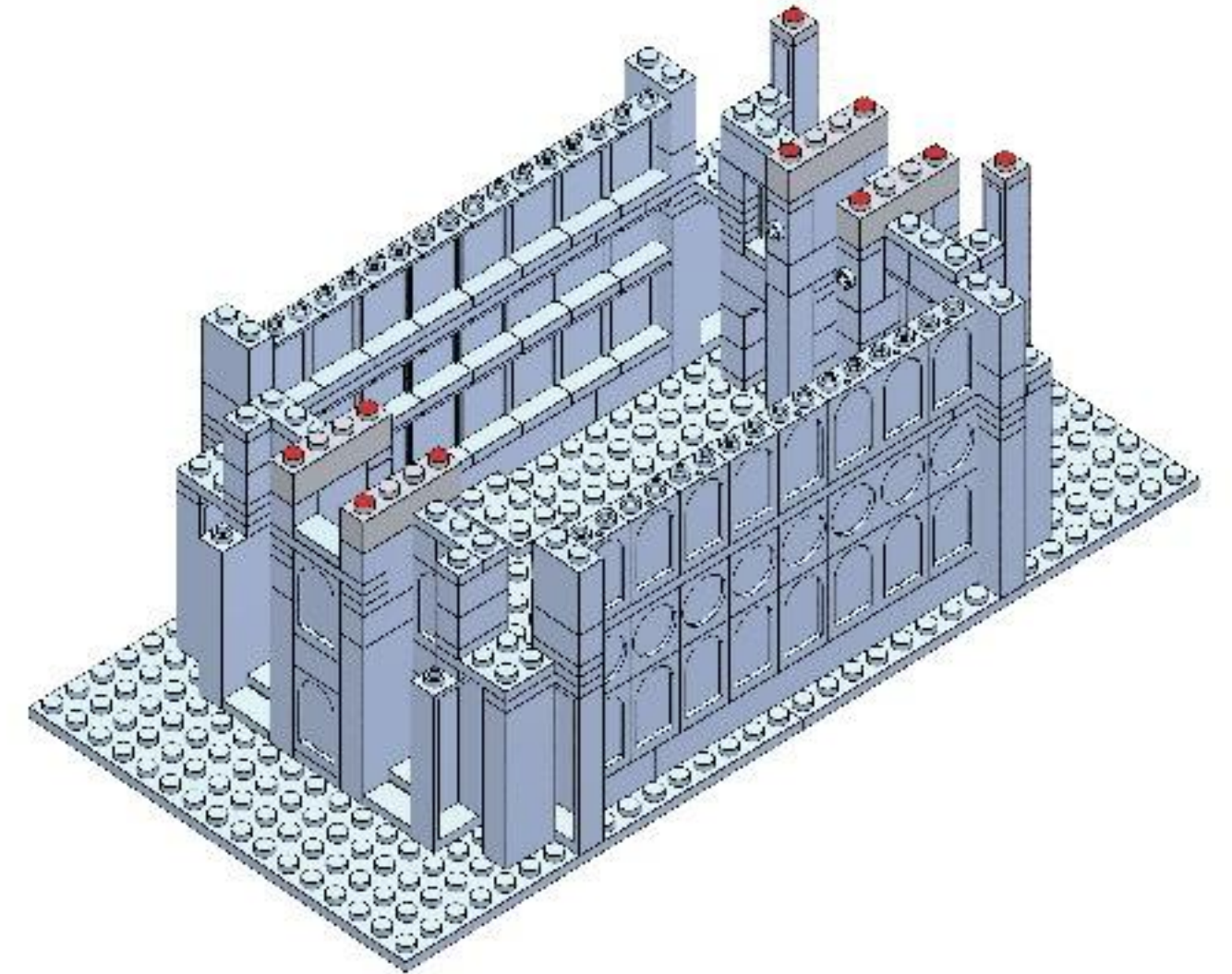

(17)

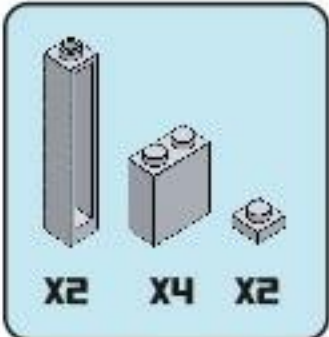

18

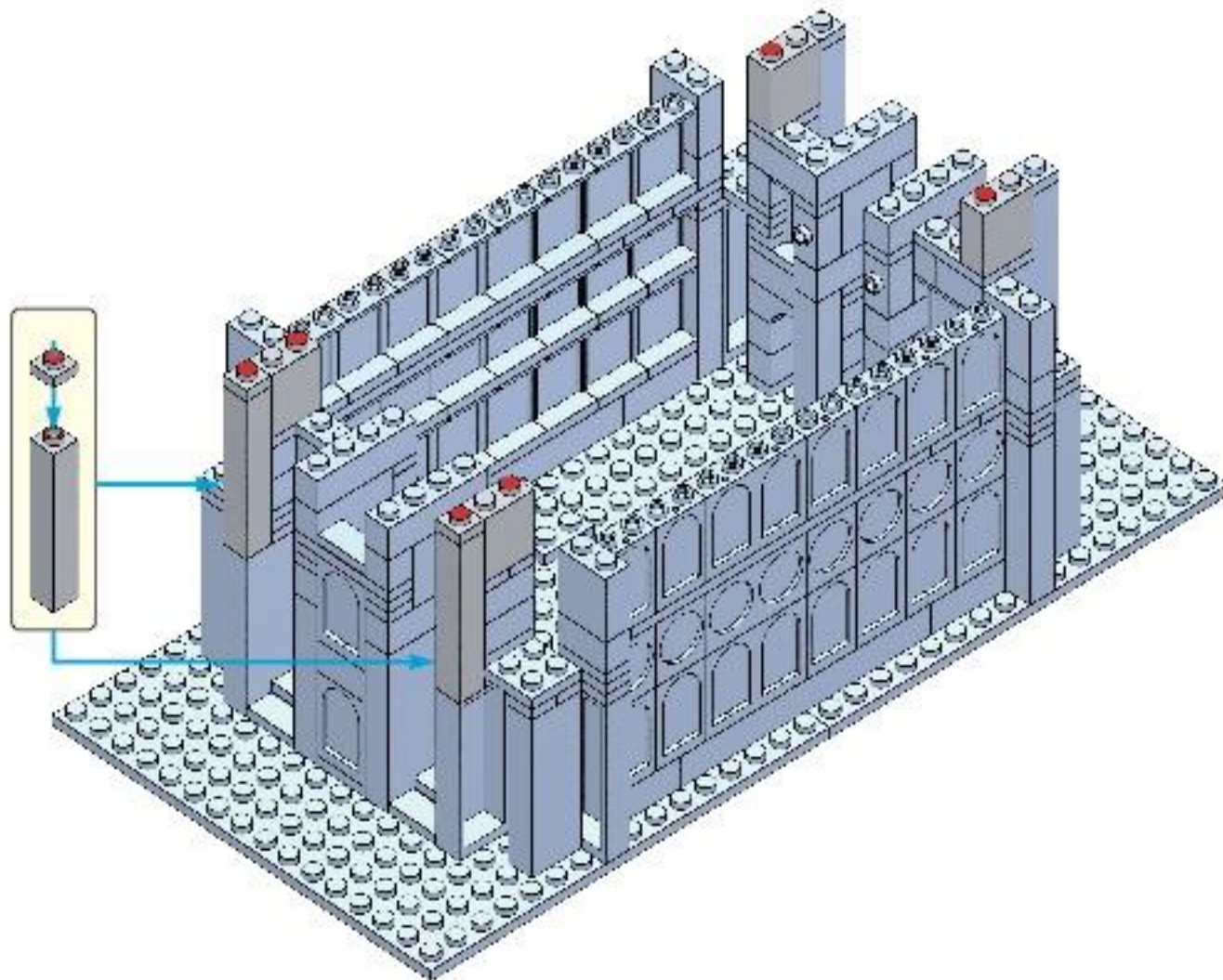

(18)

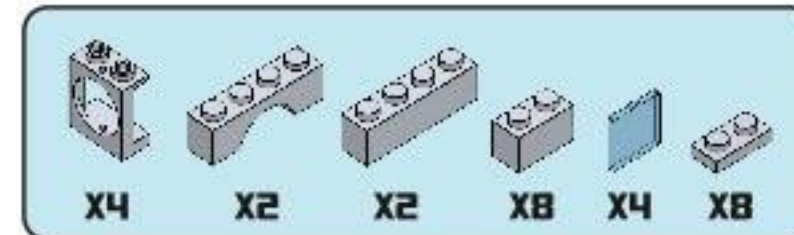

19

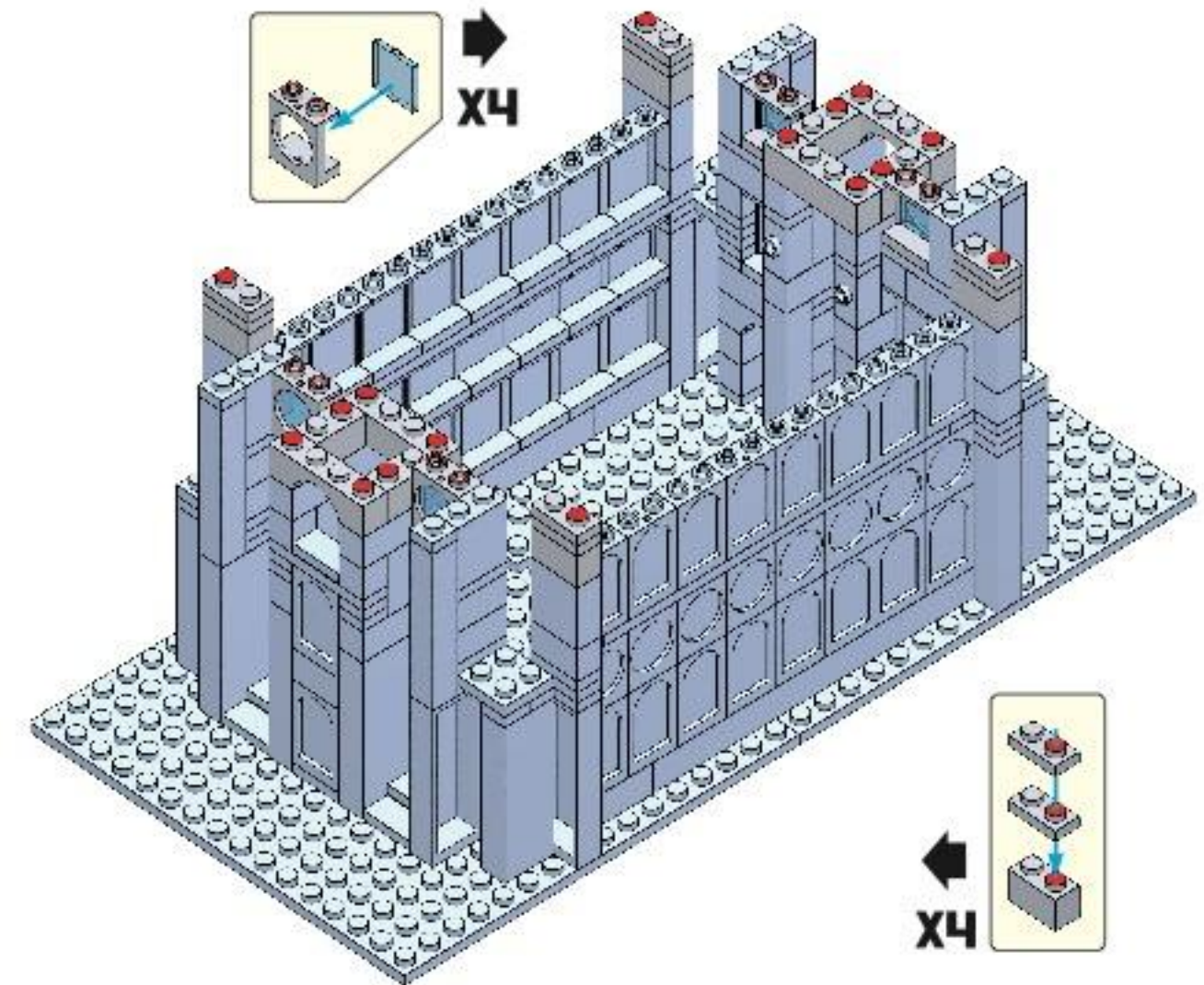

(19)

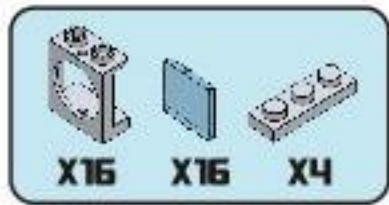

20

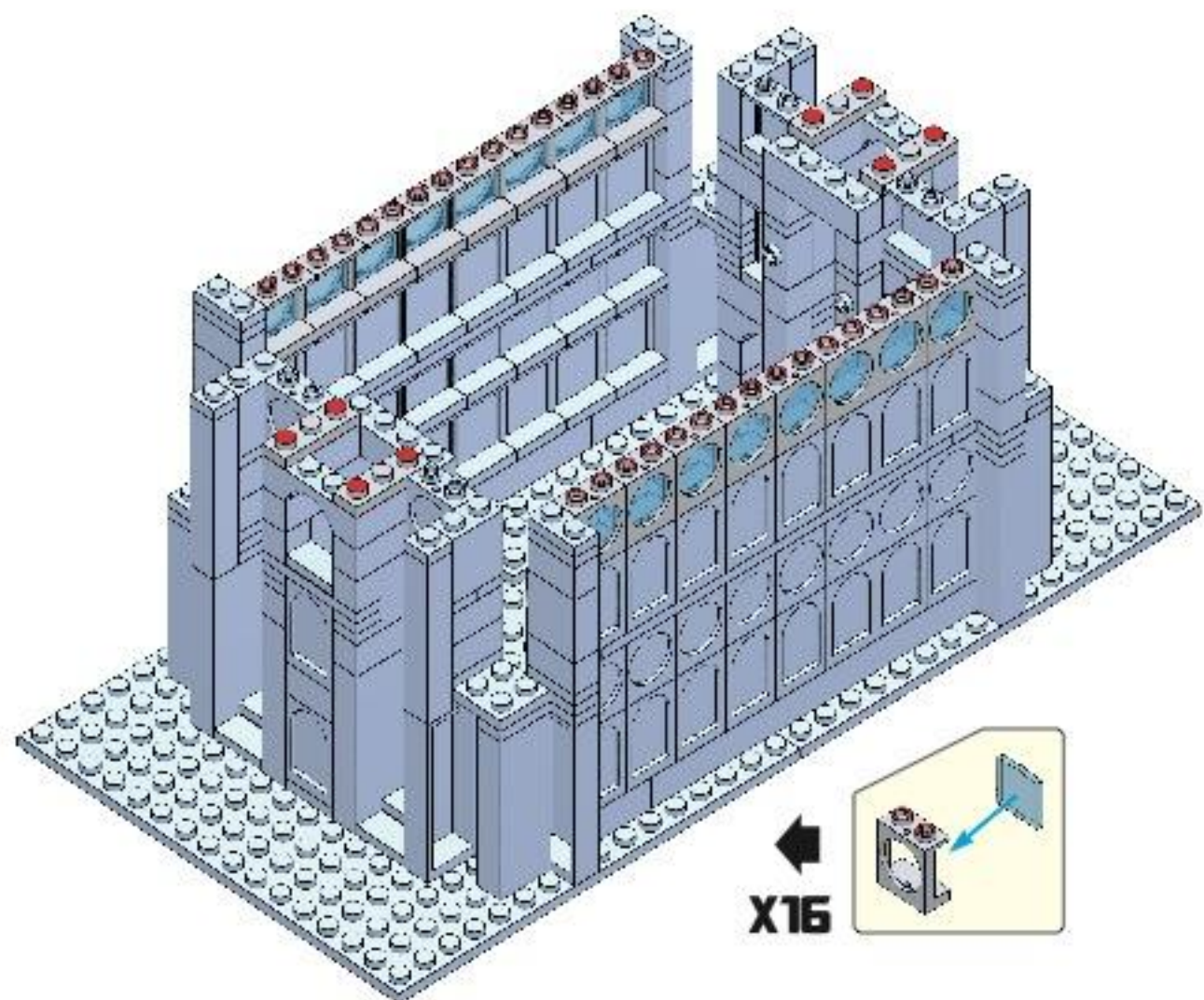

(20)

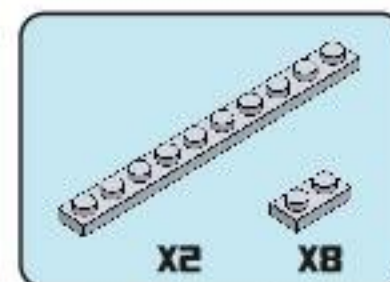

21

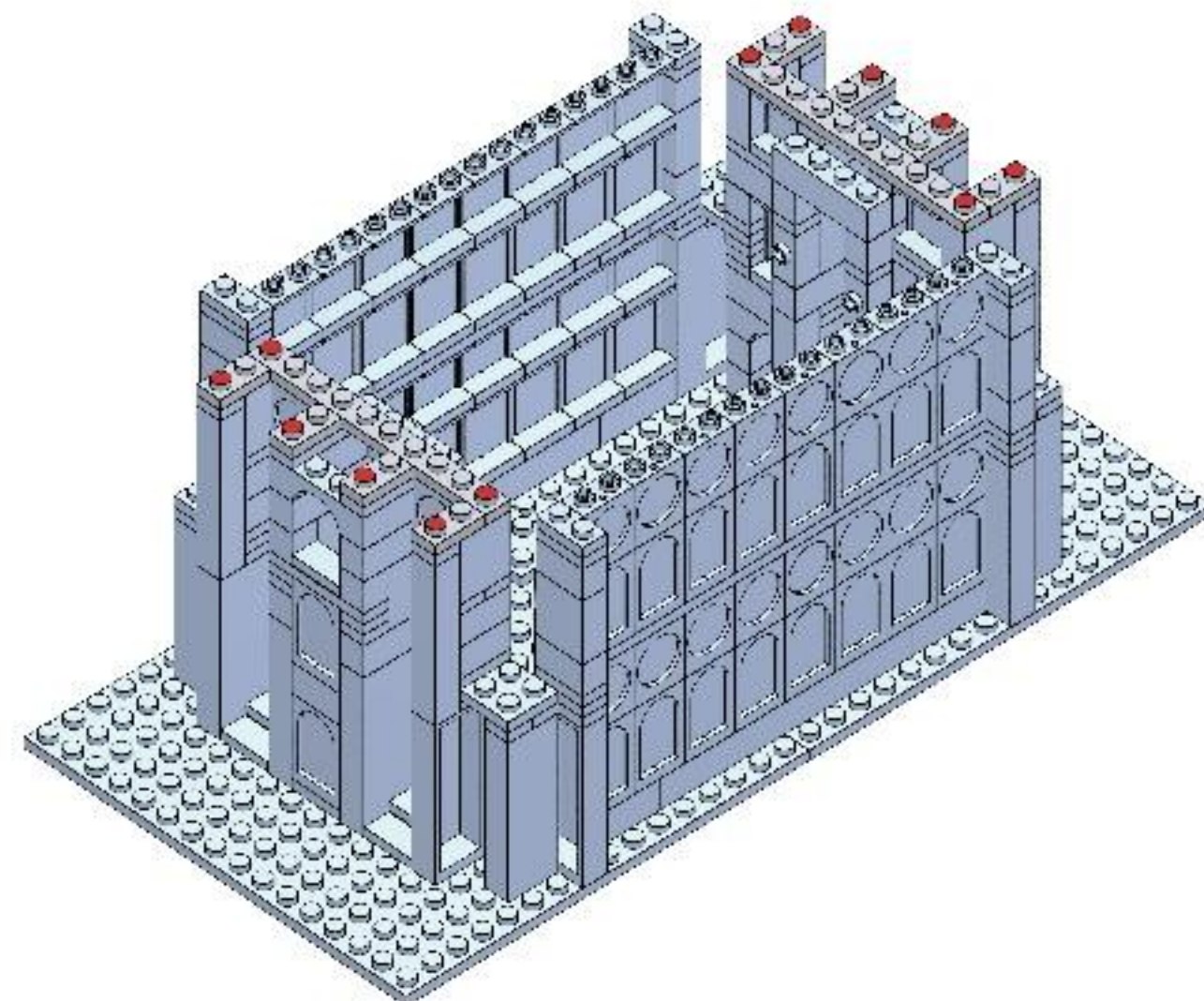

(21)

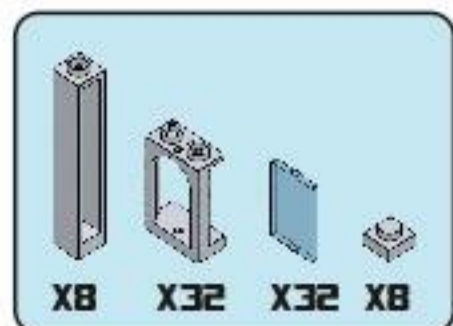

22

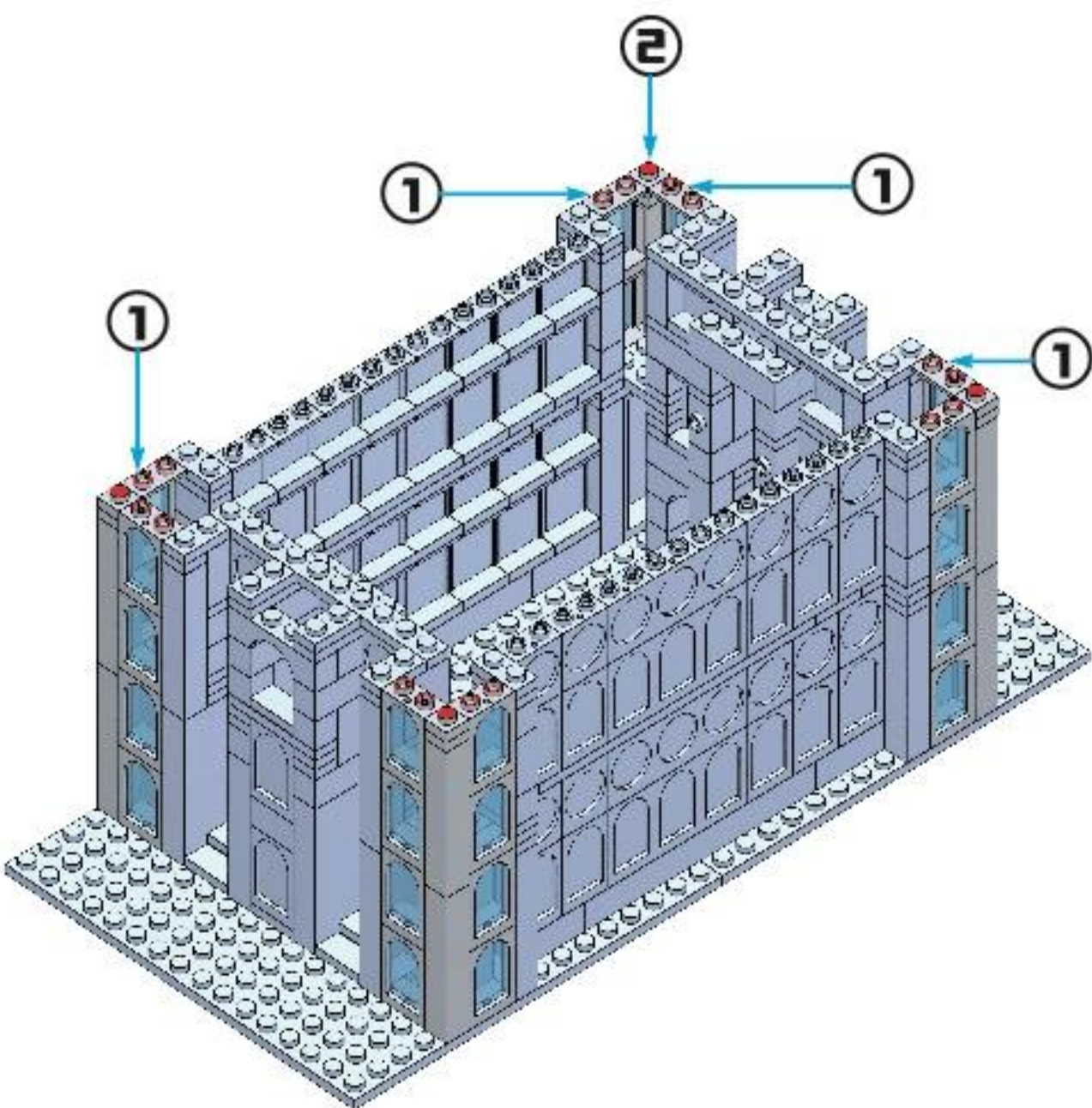
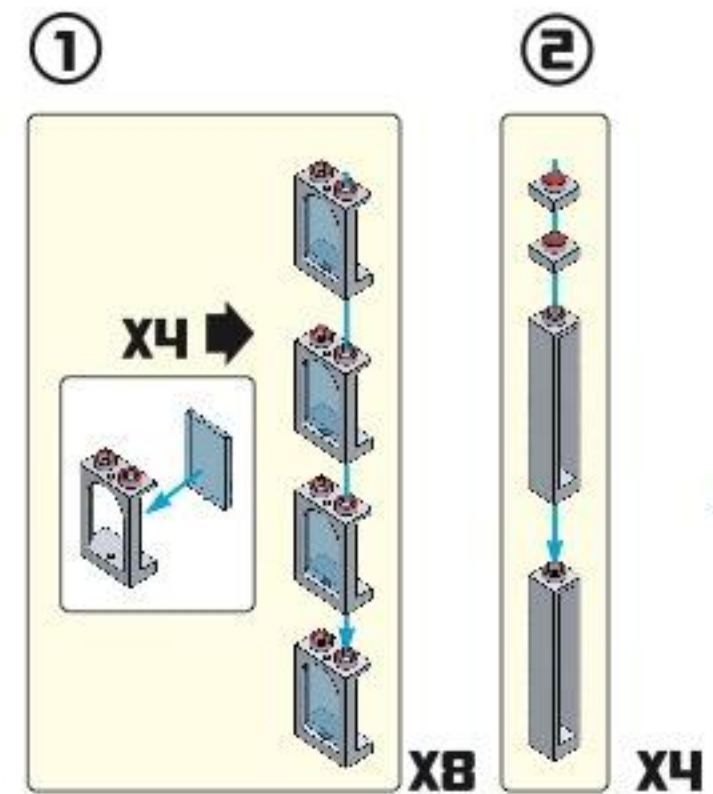

(22)

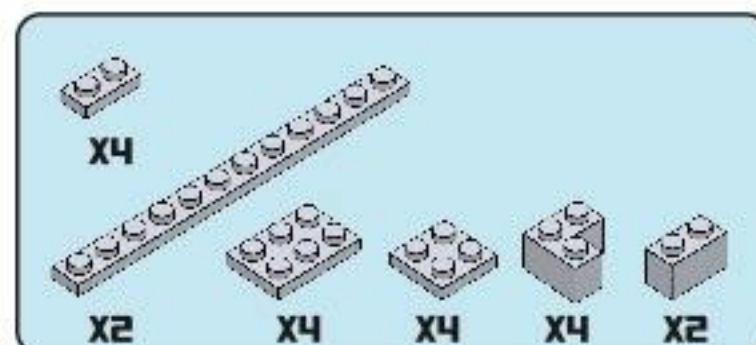

23

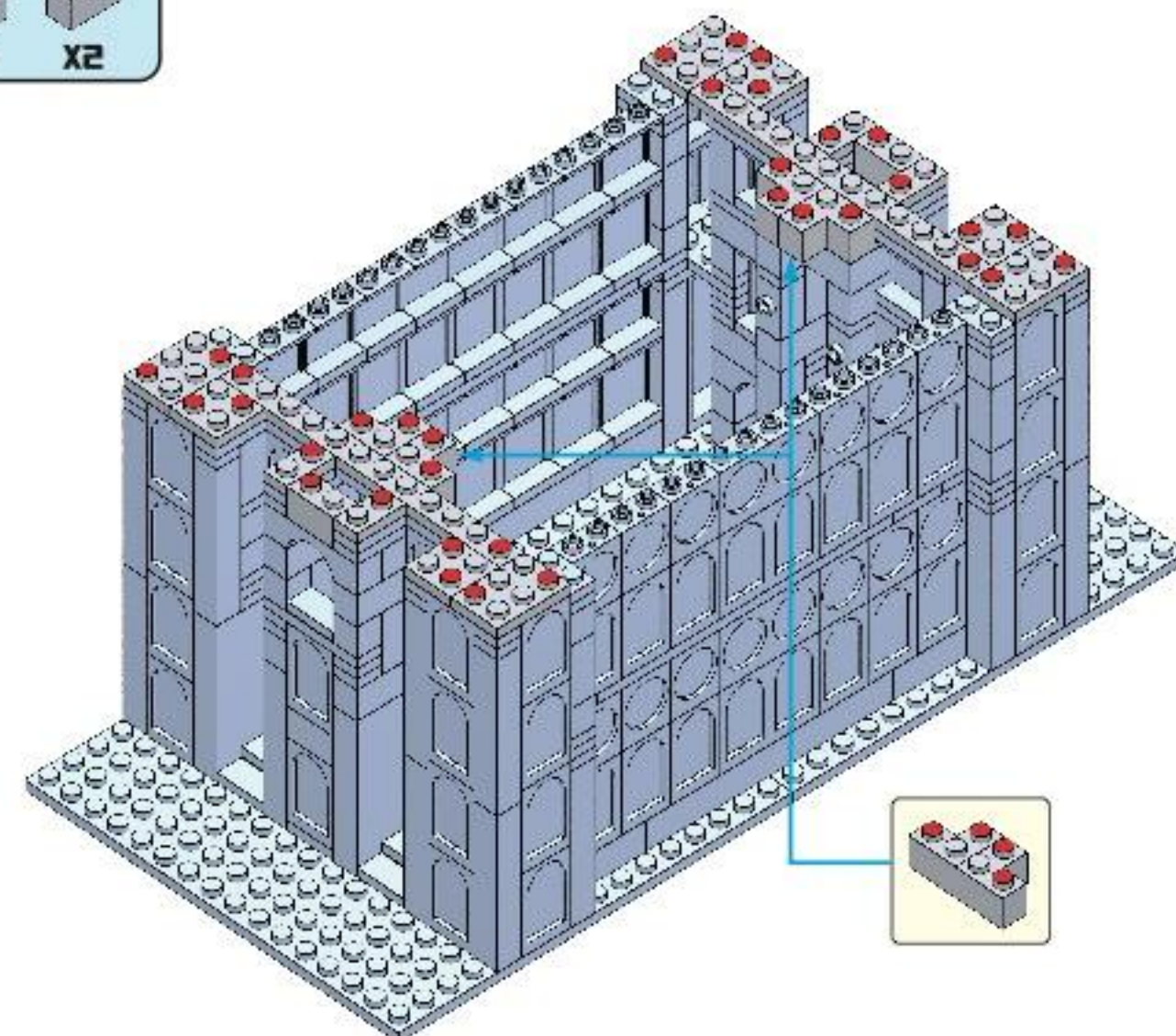

(23)

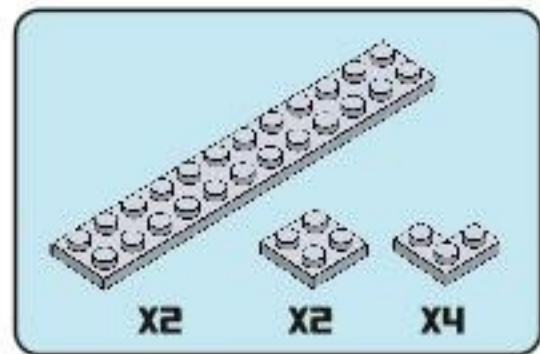

24

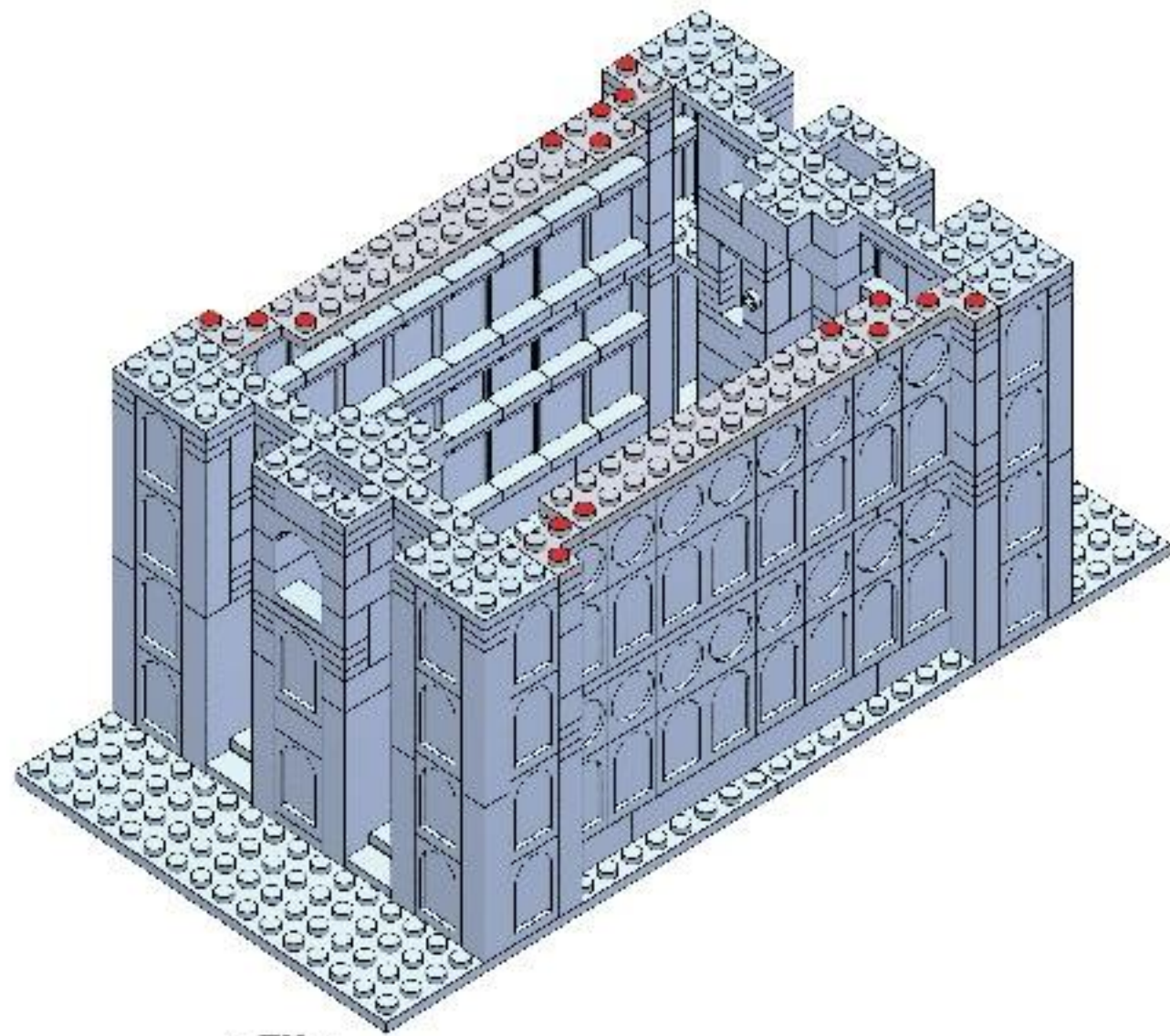

(24)



25

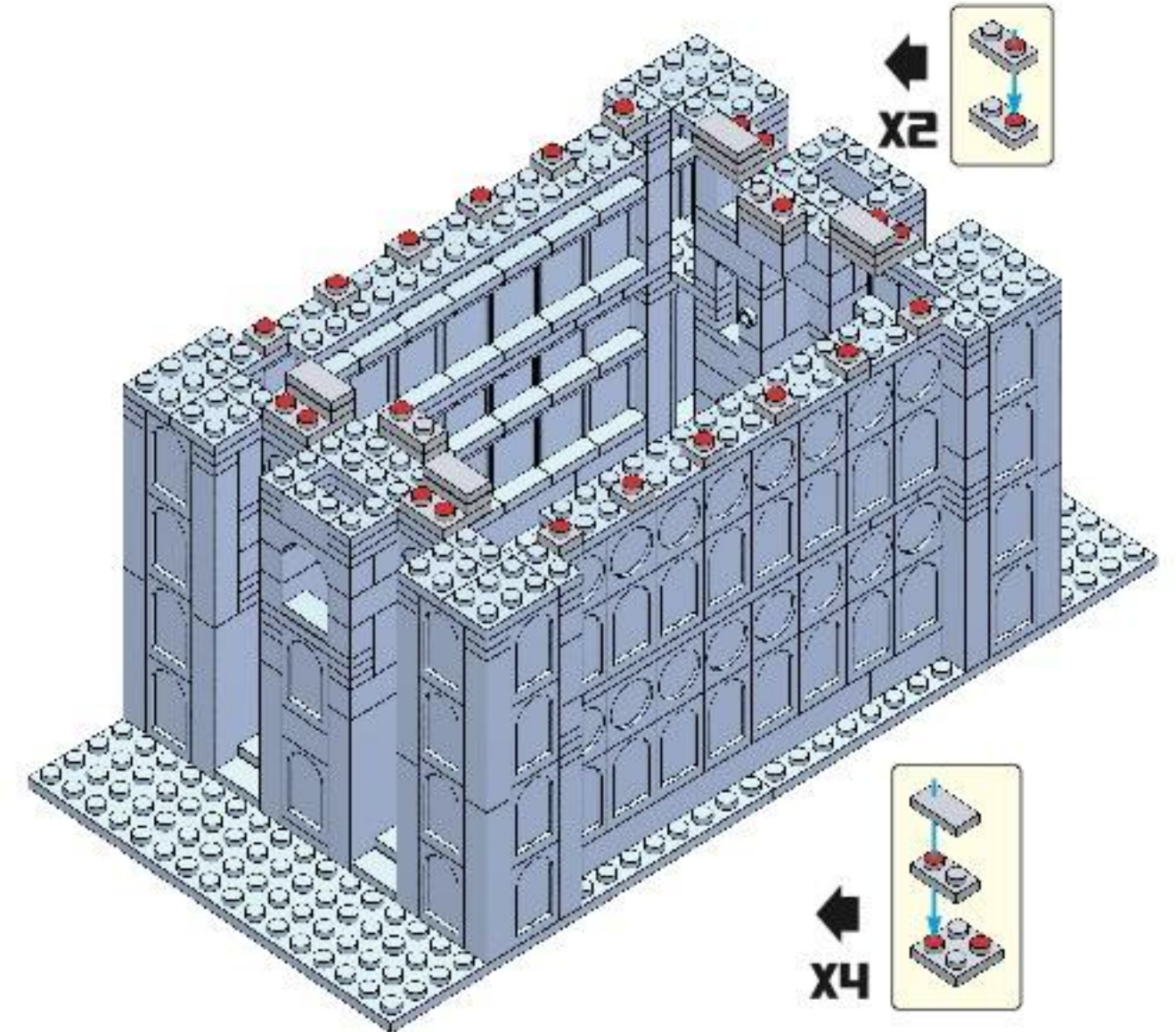

(25)

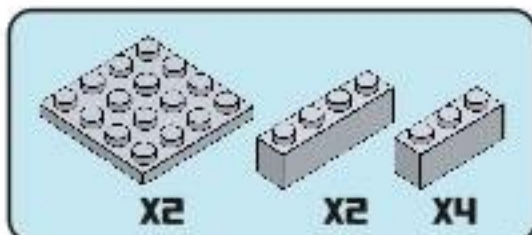

26

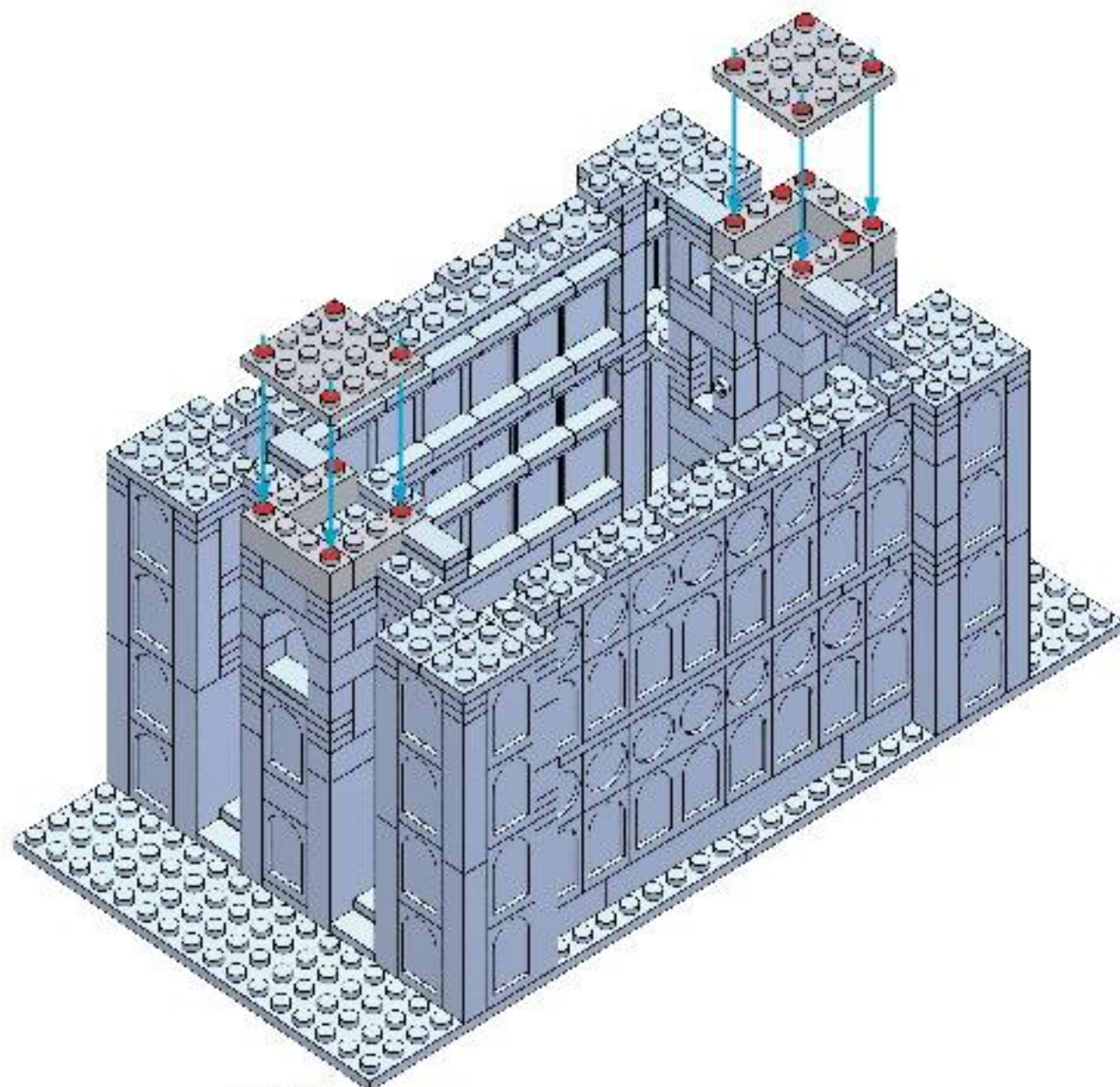

(26)

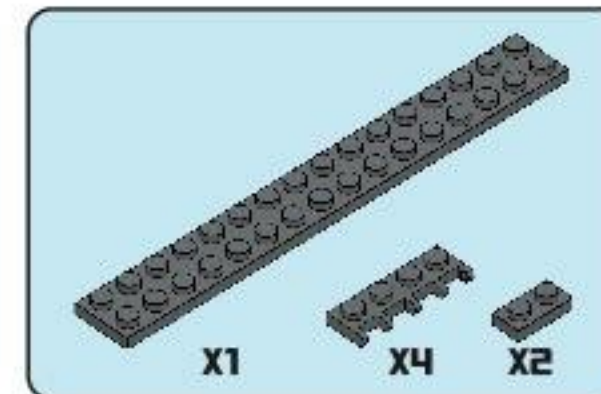

27

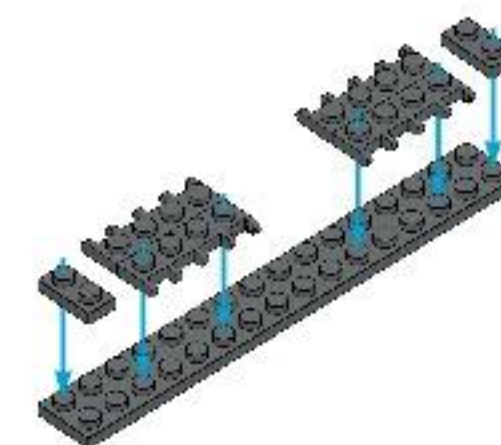

28

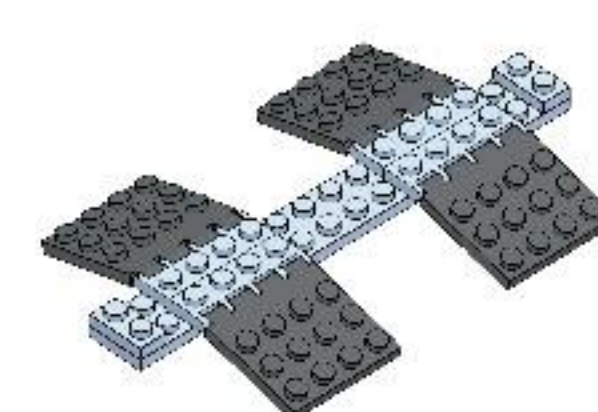

(27)

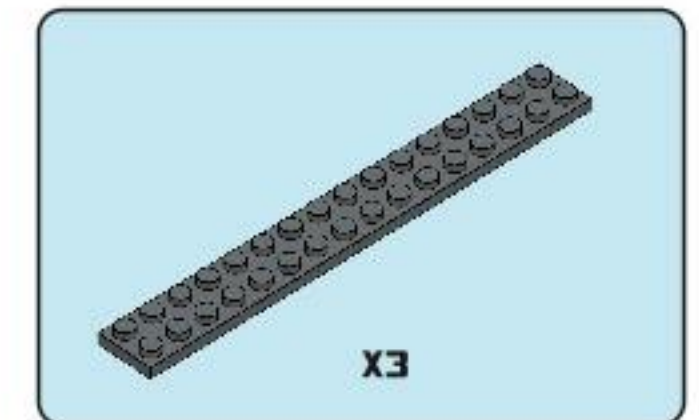

29

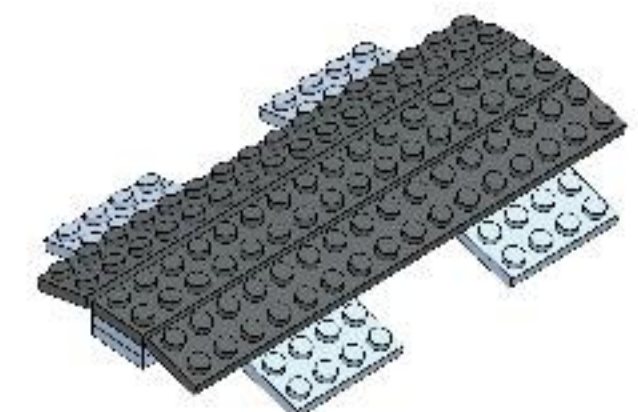

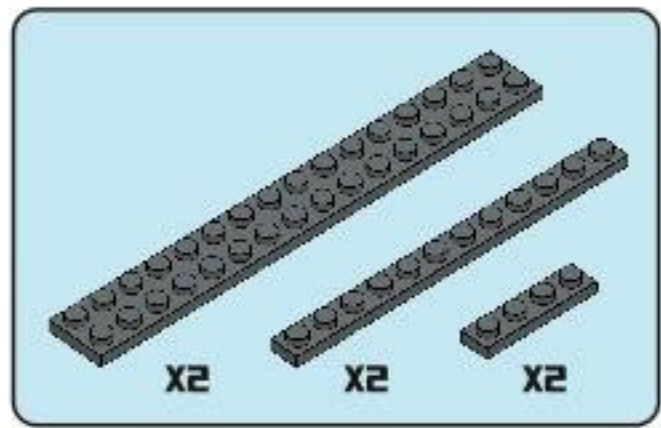

30

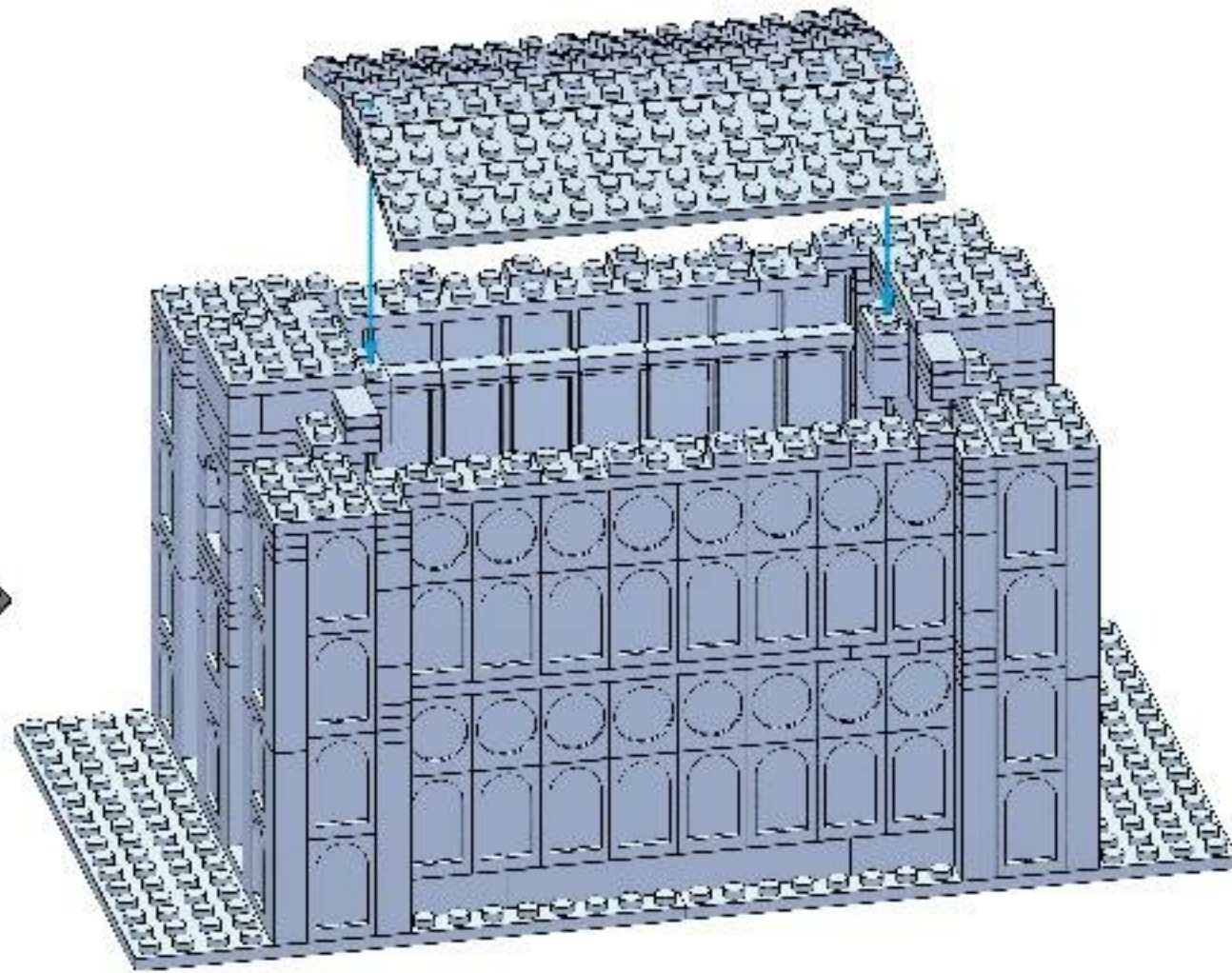
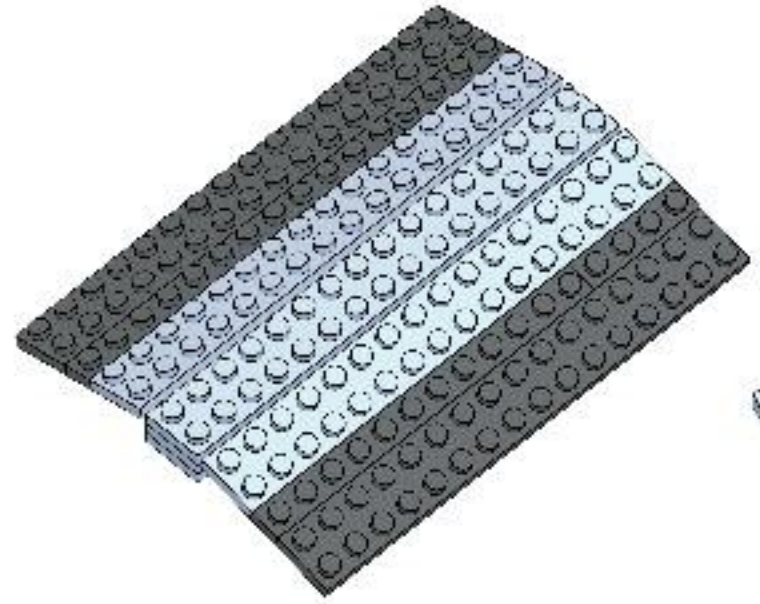

31

(28)

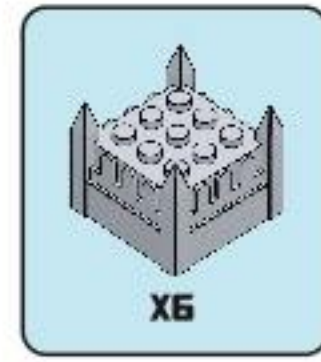

32

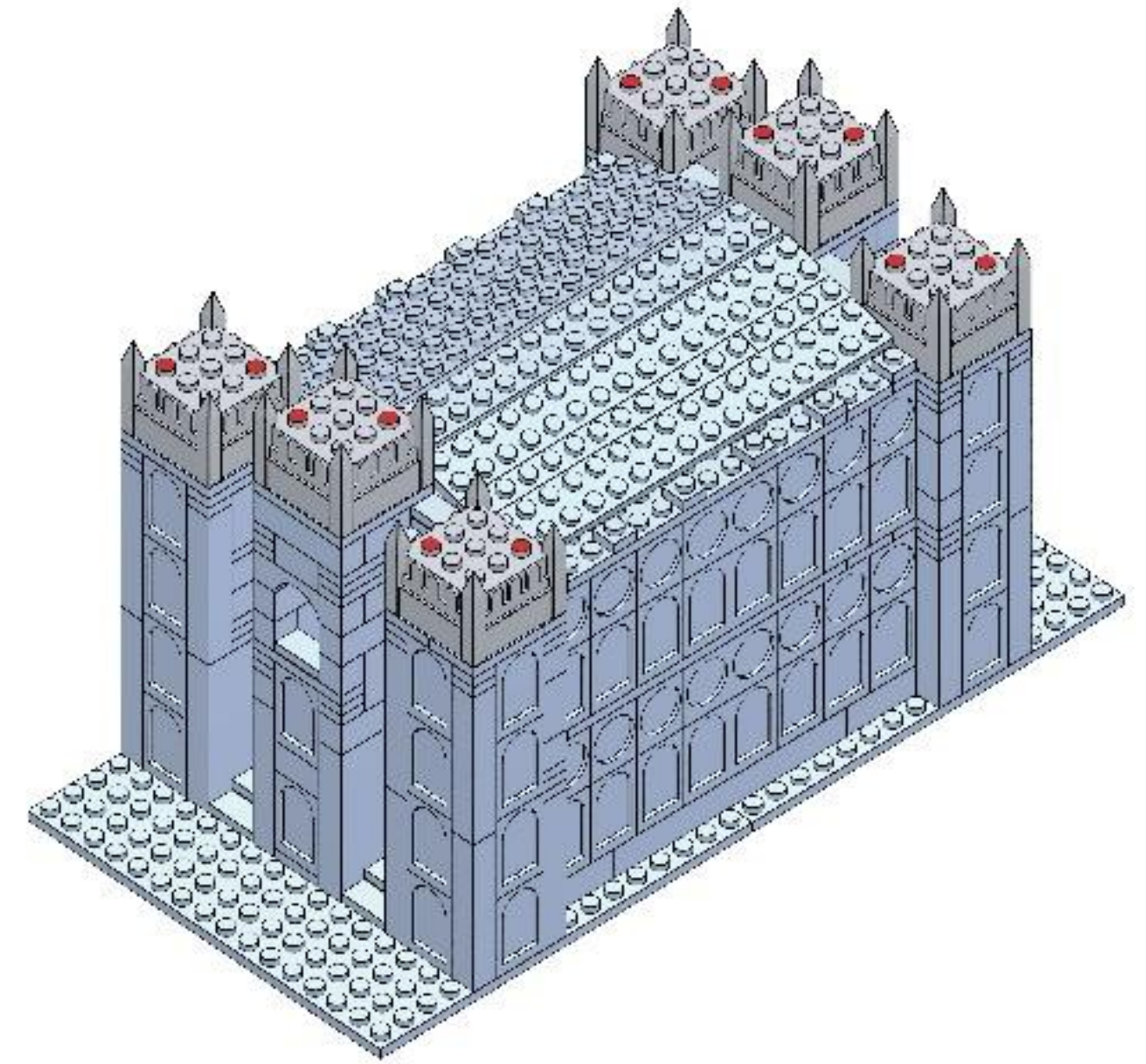

(29)



33

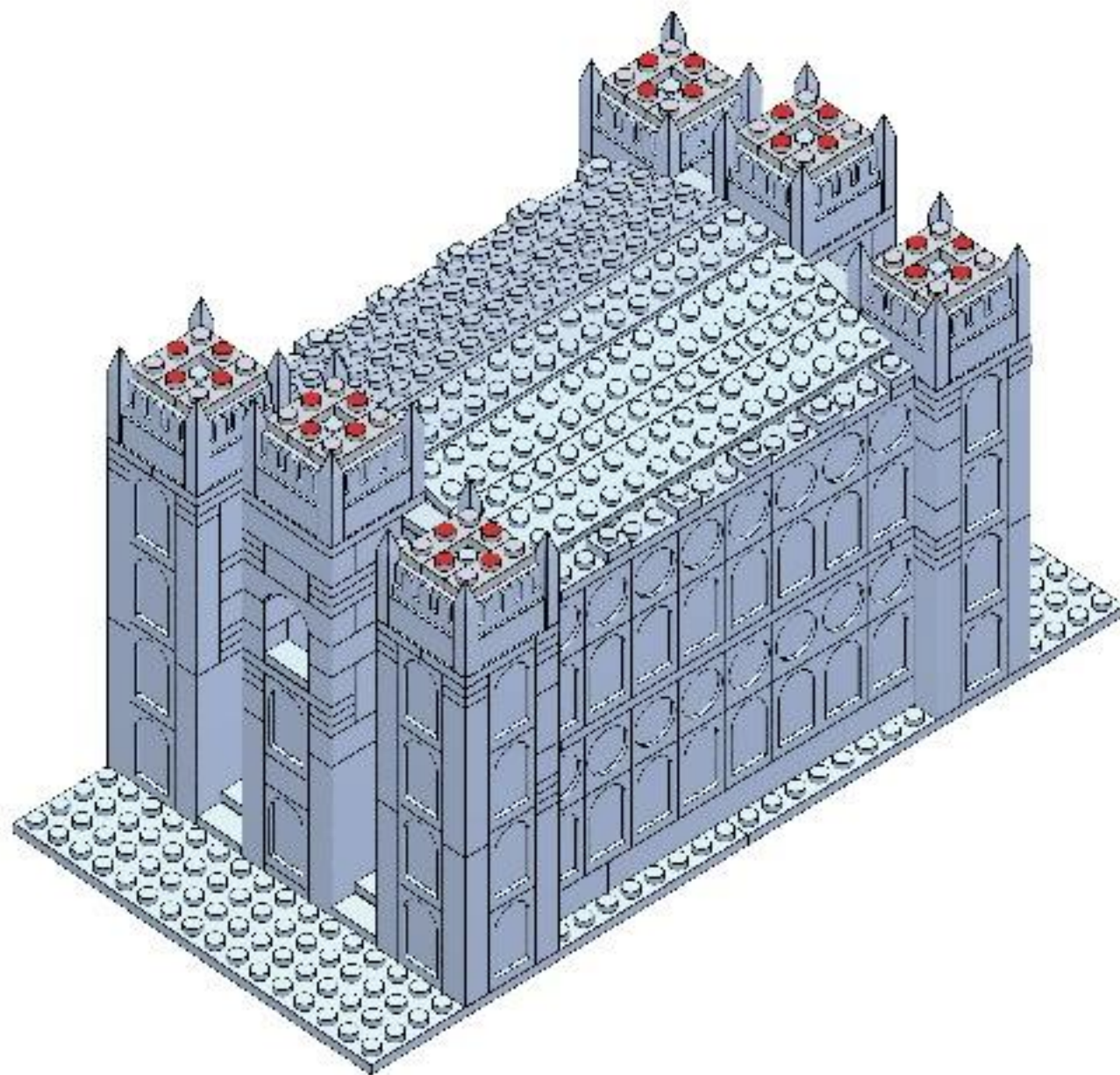

(30)

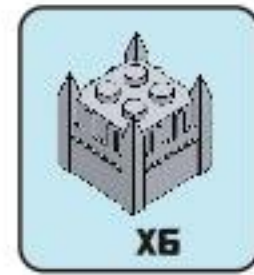

34

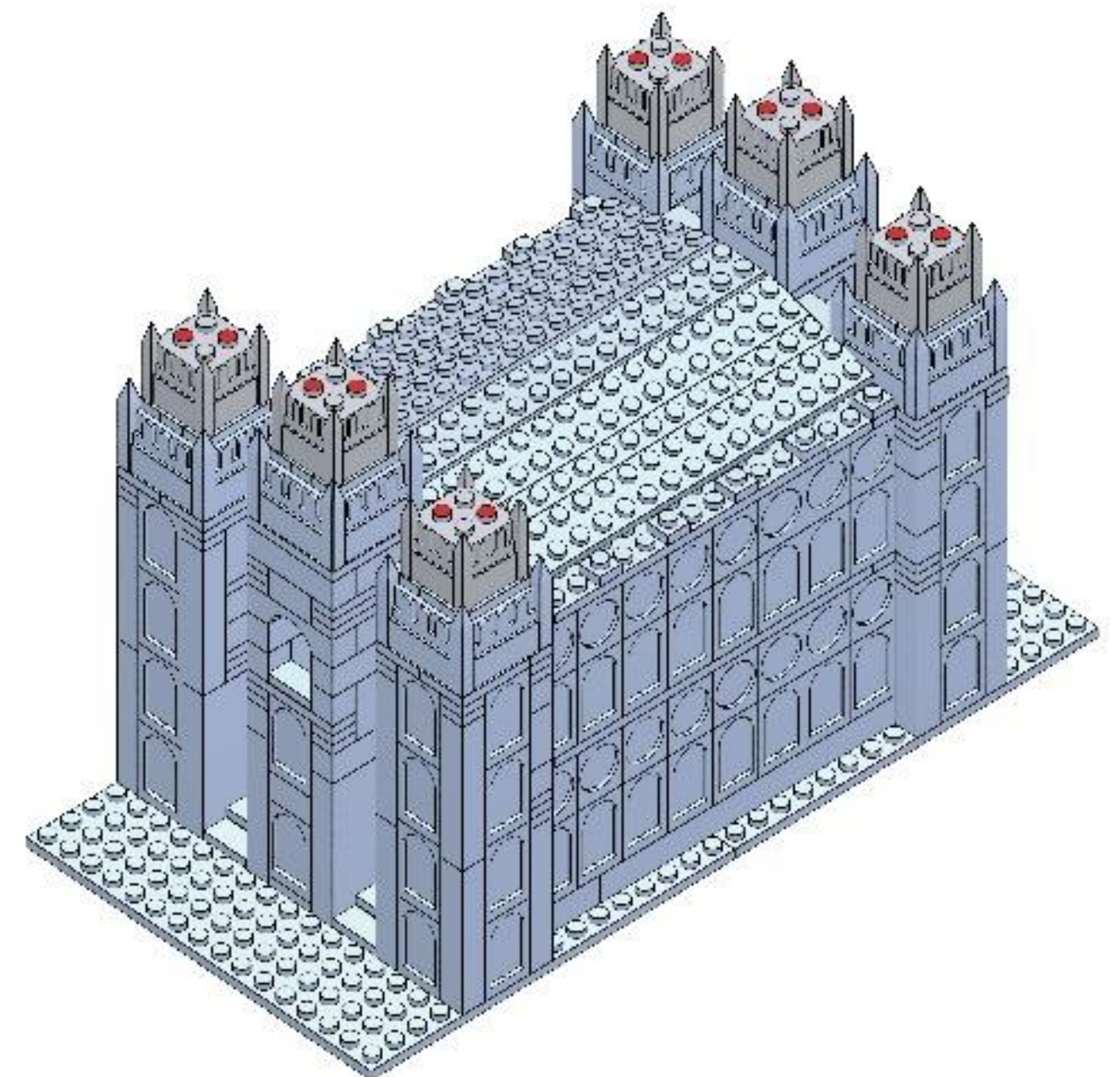

(31)

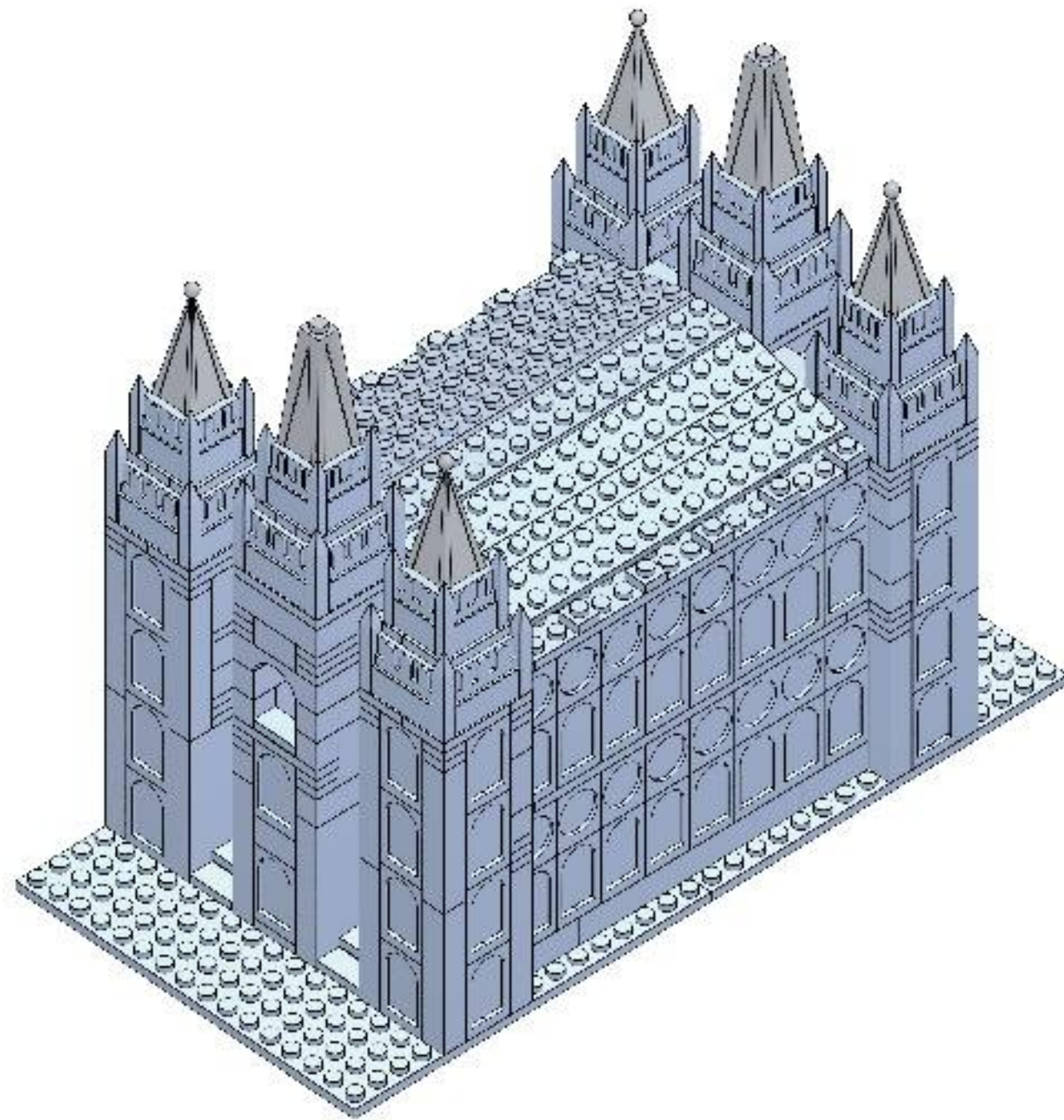

(32)

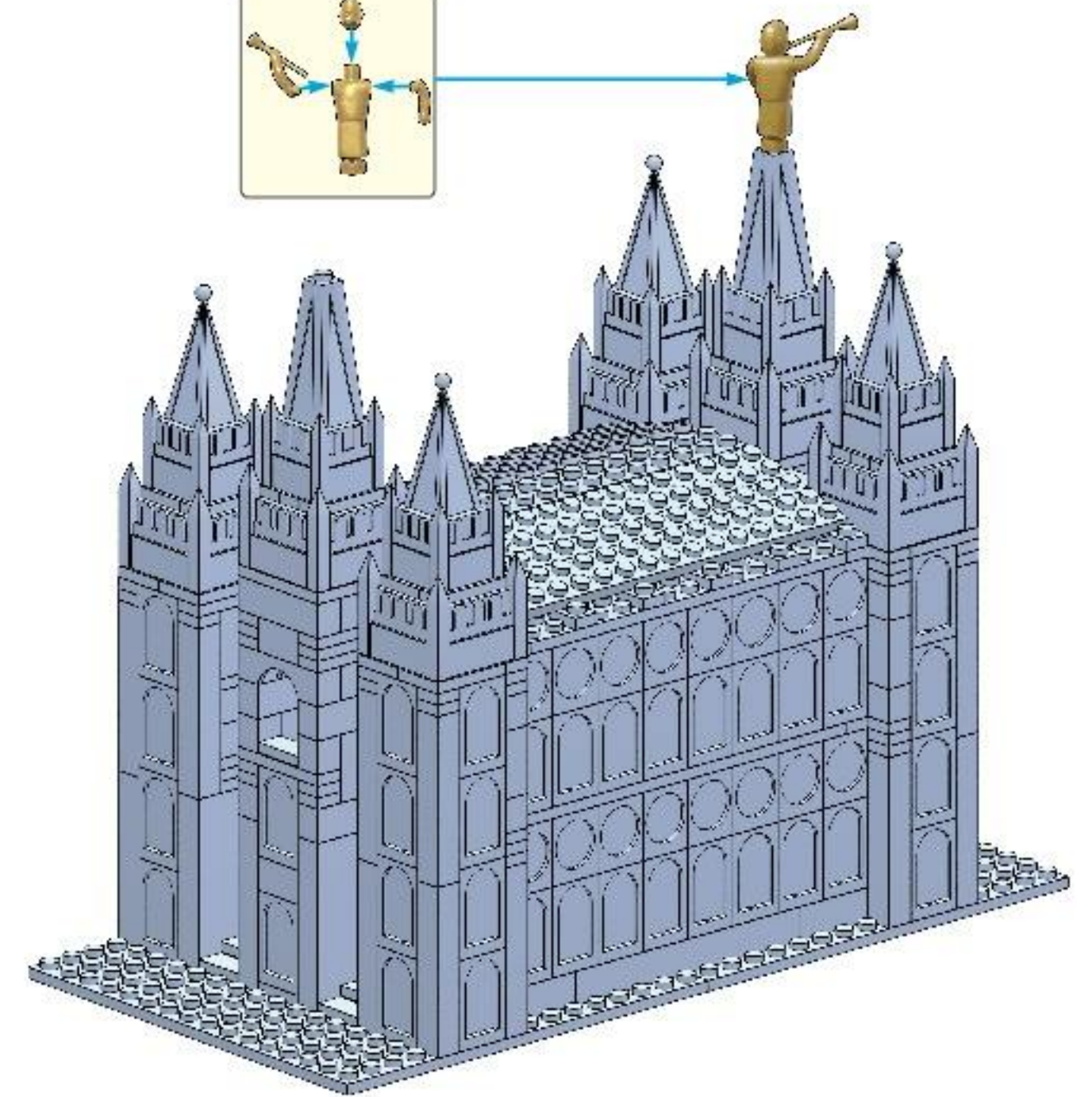
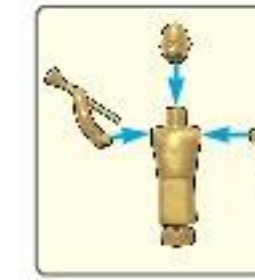
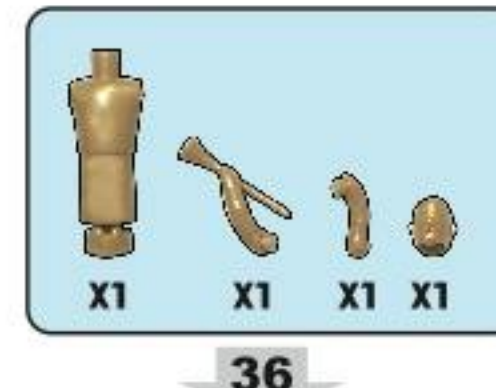

(33)



(34)

FINAL STEP: JOIN OUR COMMUNITY OF BUILDERS
 EMAIL YOUR PICTURES TO INFO@BRICKEMYOUNG.COM
 AND GET 15% OFF YOUR NEXT PURCHASE!
WWW.BRICKEMYOUNG.COM

