

**Brick'Em
Young™**

Oakland Temple

954 Pieces

Product# 34:2

Ages 12+

www.brickemyoung.com

**standard size bricks
Toy Brick Building Set**



1. The Oakland Temple groundbreaking and site dedication was done on May 26, 1962 by President David O. McKay.
2. The Oakland Temple was dedicated around two and half years later on November 7, 1964 also by President David O. McKay.
3. The Oakland Temple is the second temple built in California. The first temple built in California is the Los Angeles Temple in 1956.
4. The Oakland Temple is one of three temples with one central tower surrounded by four corner towers. The other two temples are the Cochabamba Bolivia and Provo City Center Temples.
5. The exterior of the temple consists of reinforced concrete faced with Sierra white granite from Raymond, California.
6. The Oakland Temple grounds are accented by flowers, palm trees, fountains and a man-made stream.
7. The Oakland Temple can be seen from a long distance in the bay area of Northern California due to its geographical location on a hill in the East Bay.
8. The Oakland Temple is a structure which many Northern California residents enjoy. The Oakland tourism association has the following to say about the Oakland Temple:
“While you can’t set foot inside unless you’re a part of the church, you can still explore the grounds and the terrace — one of the best views of the bay anywhere.”
9. It is not uncommon for newly married couples from other religions to come to the temple for wedding photos outside of the temple as well as high school students on prom night and other activities.
10. The exterior of the Oakland California Temple features a 35-foot sculpted panels depicting Jesus teaching in the Holy Land.



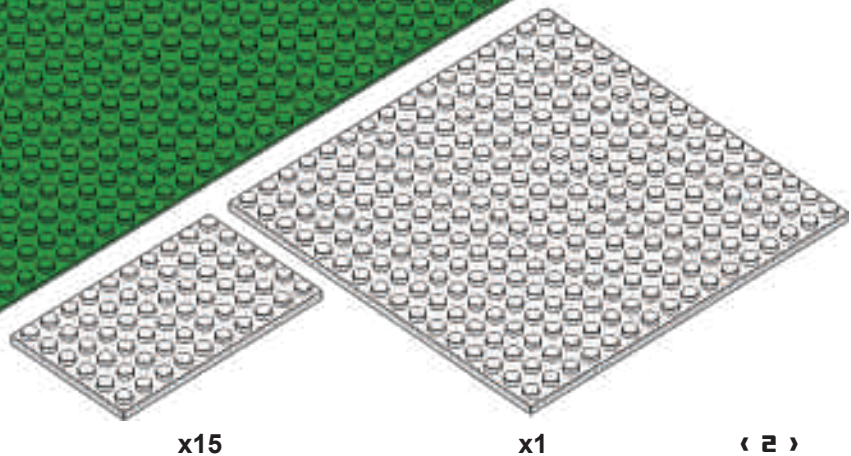
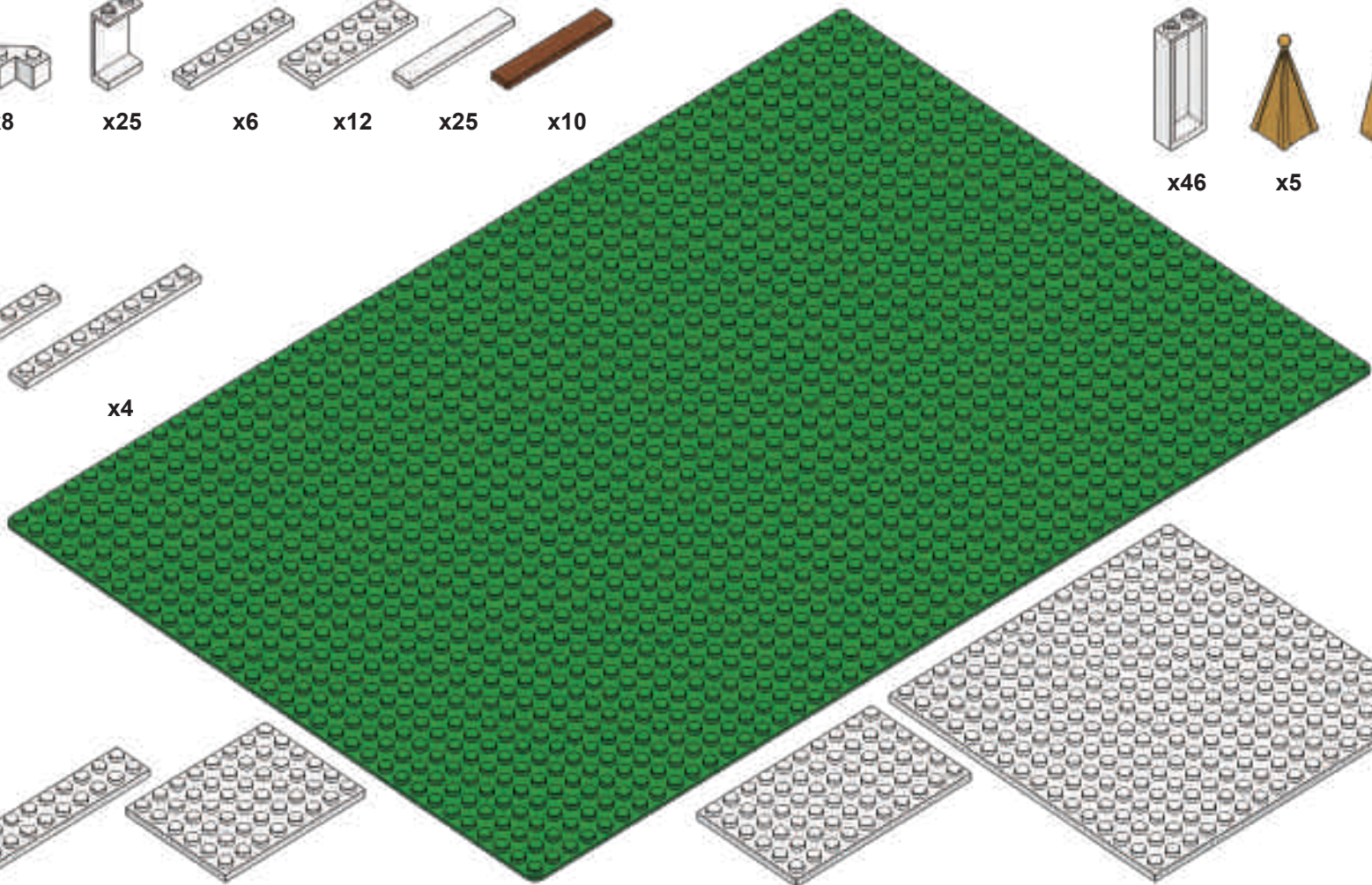
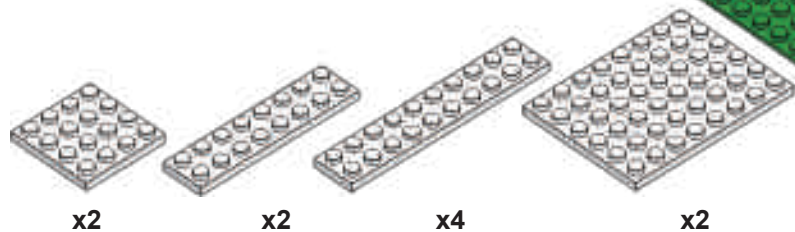
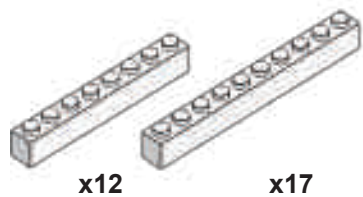
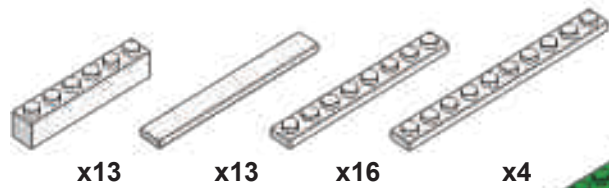
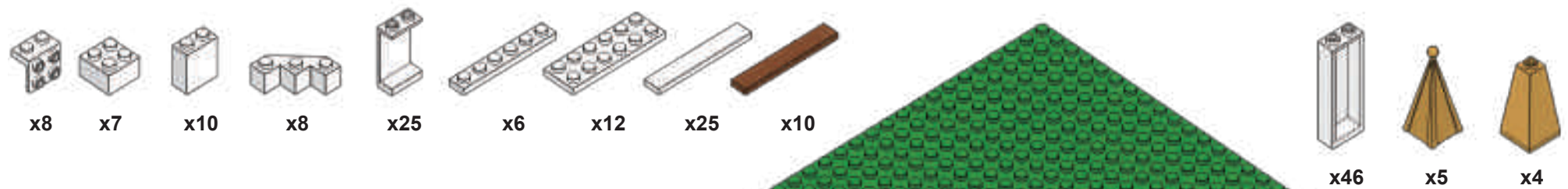
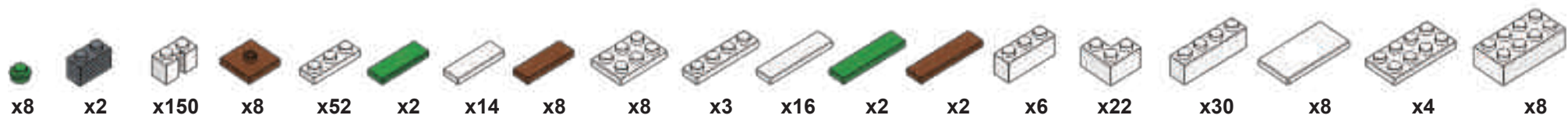



1

Hint #1: it took the pioneers 40 years to build the Salt Lake Temple, this model set may require several hours to build, enjoy the ride & take your time!

Hint#2: Find several bowls or other containers to divide up the pieces, this will greatly reduce the amount of time searching for different pieces later.

13 Points

17 Points

13 Points

17 Points

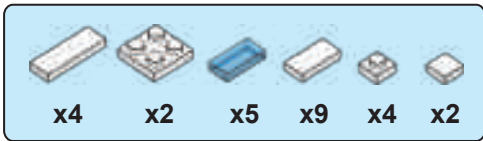

2

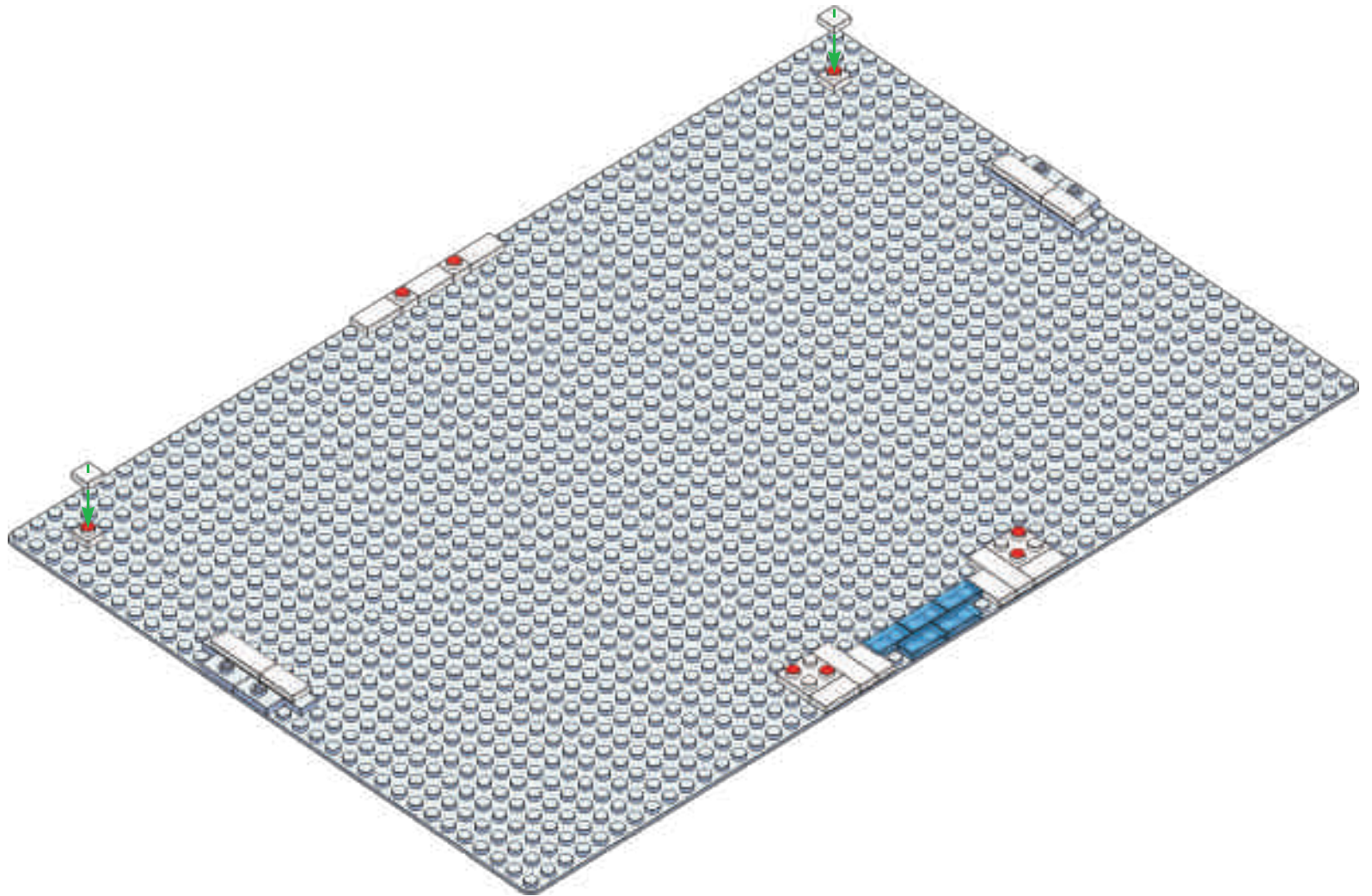

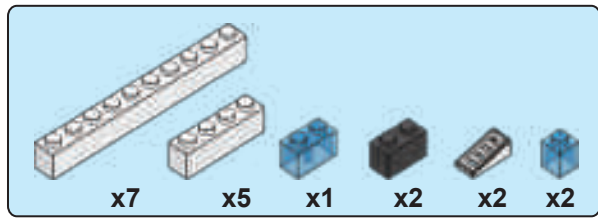

3

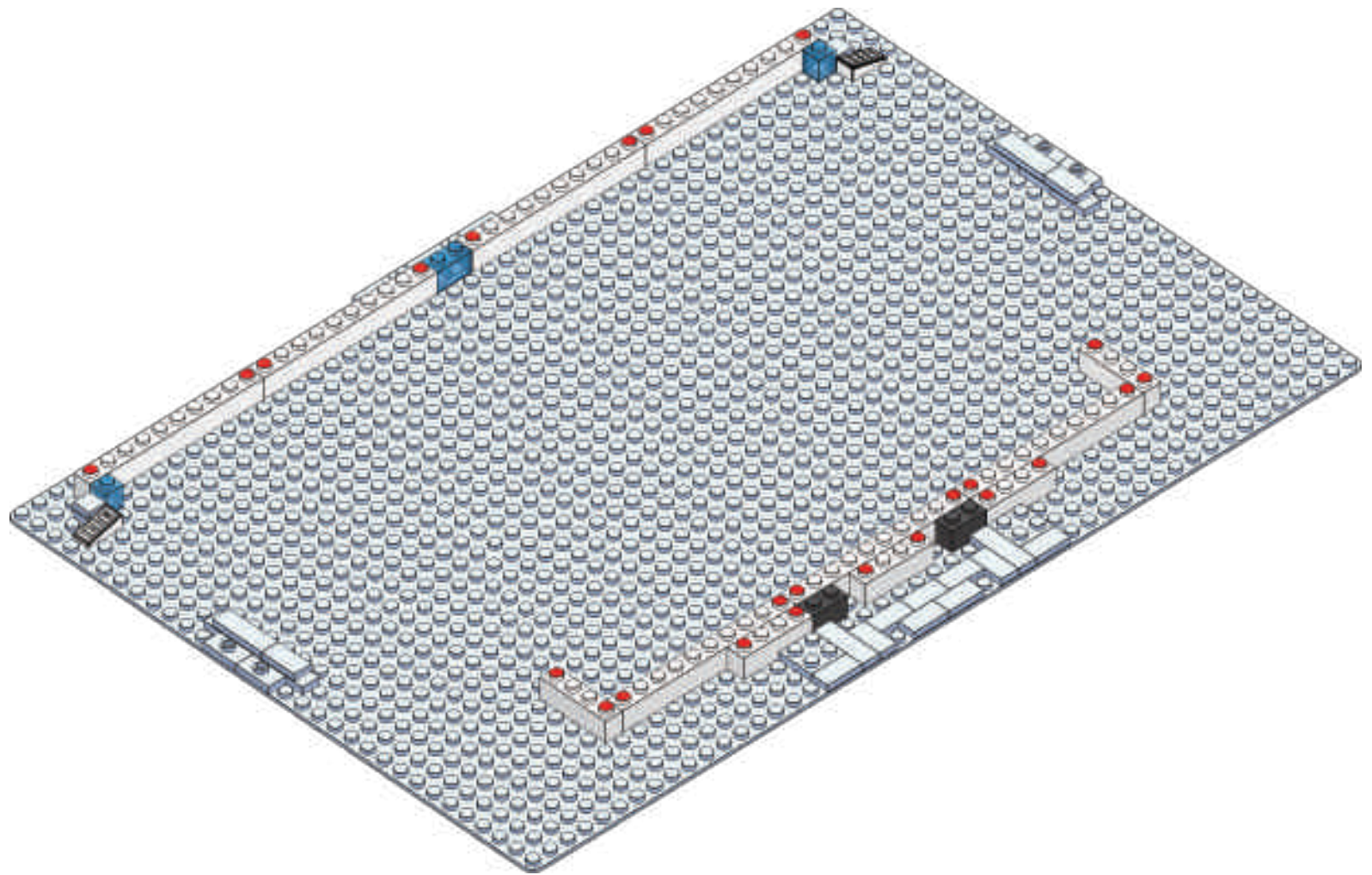

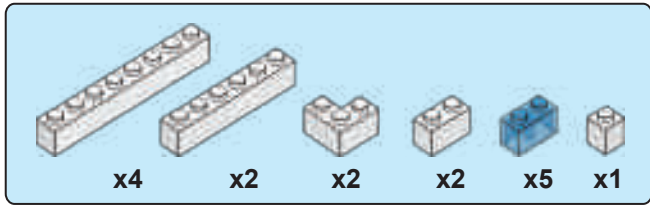

4

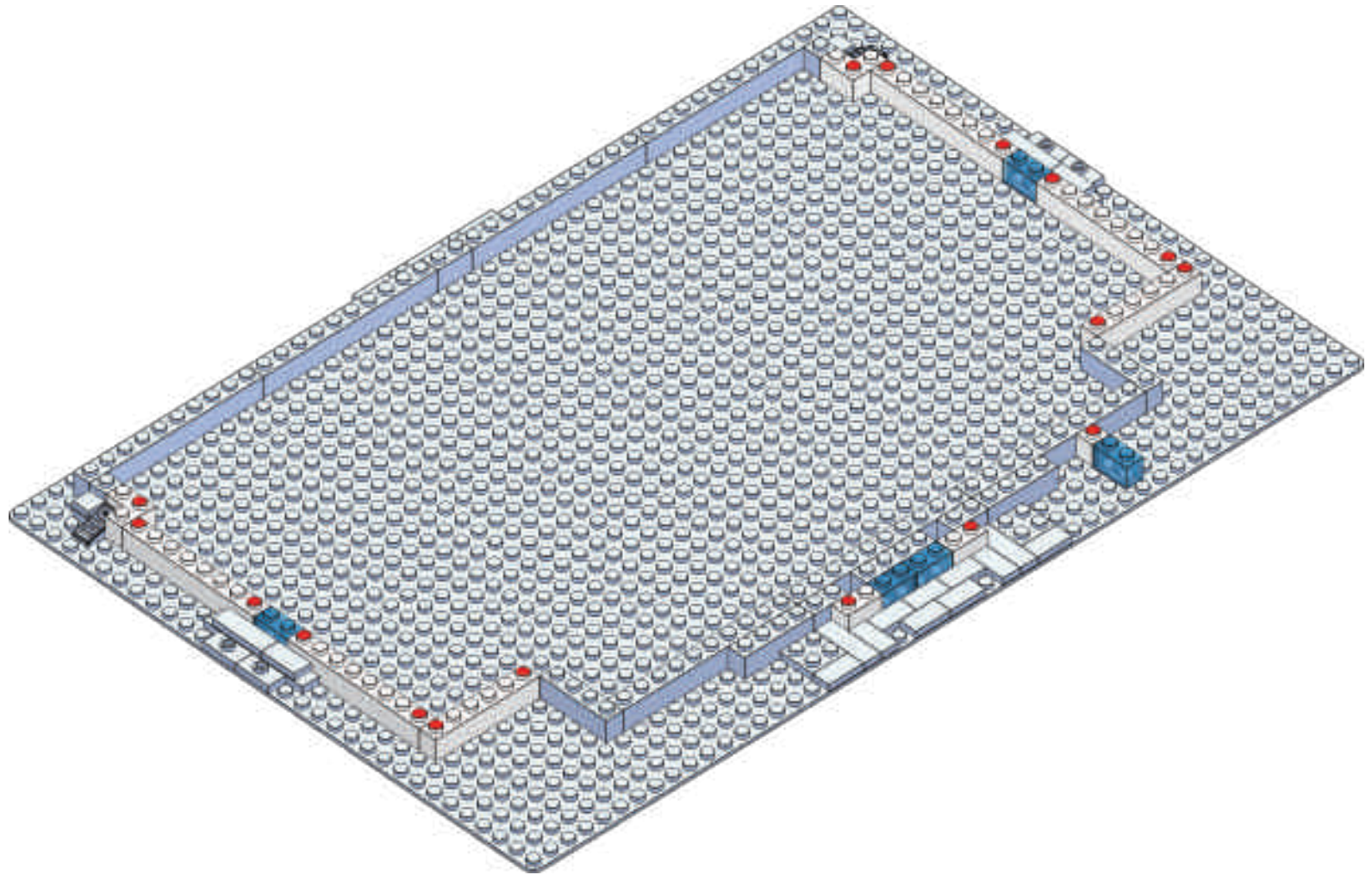



5

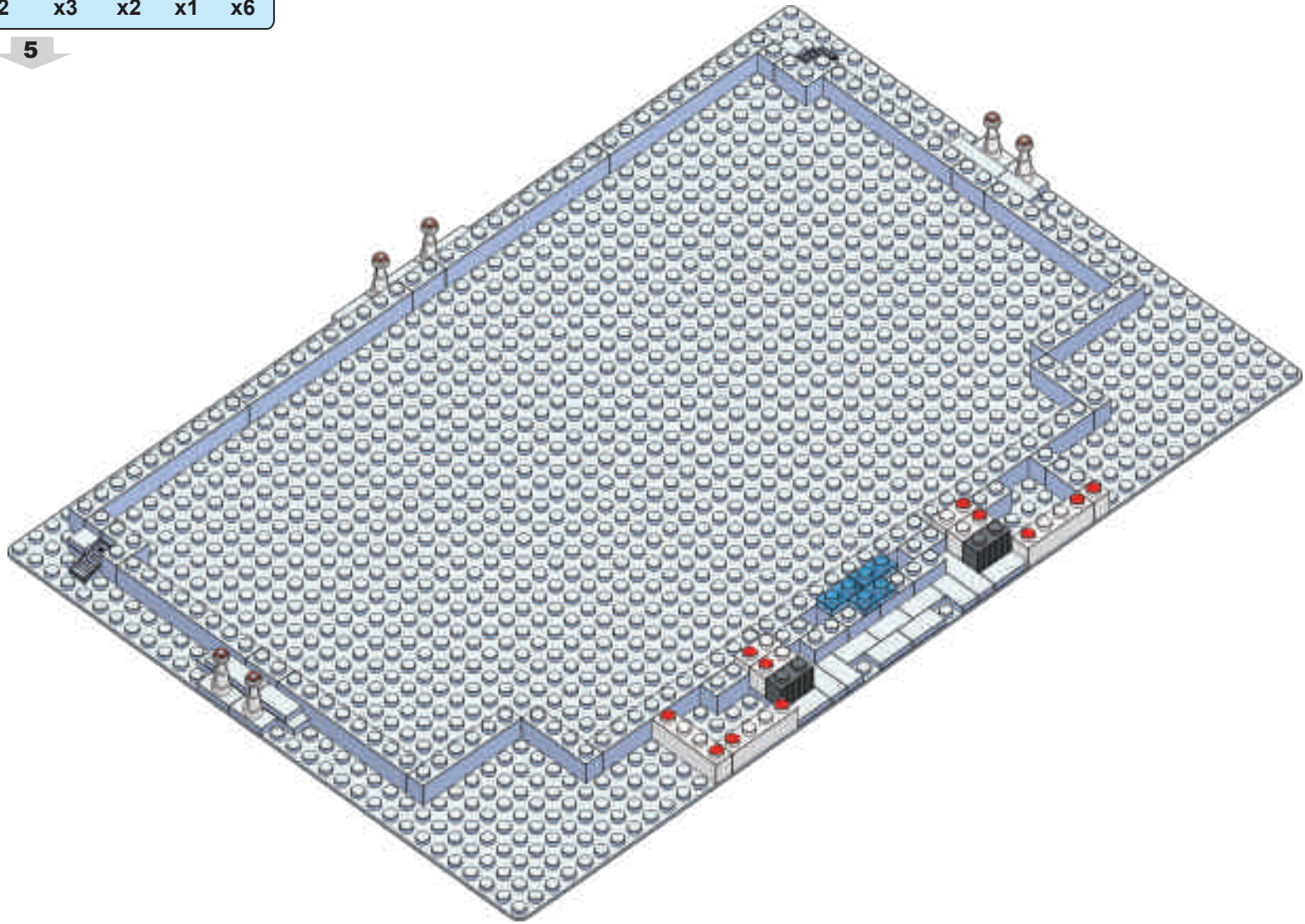

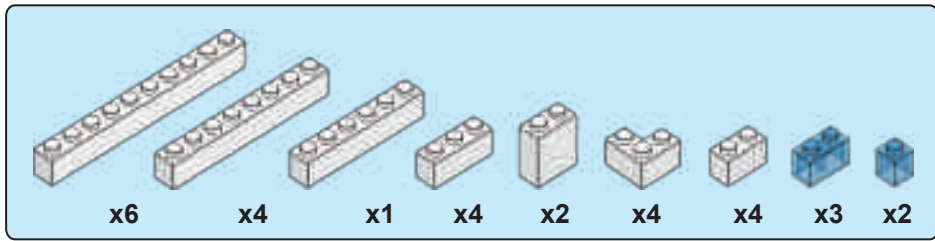

6

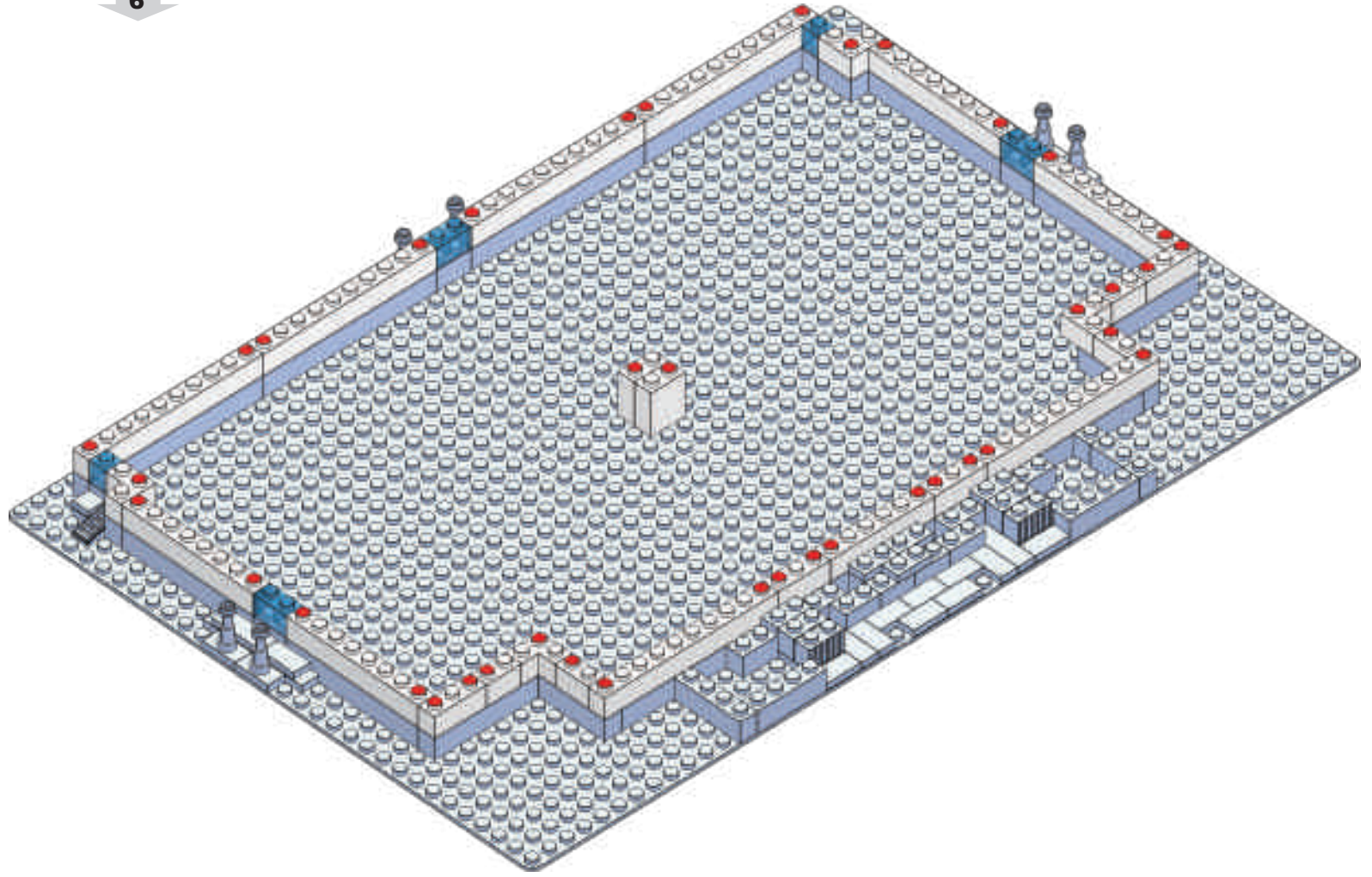

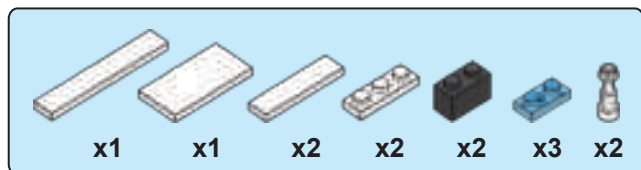

7

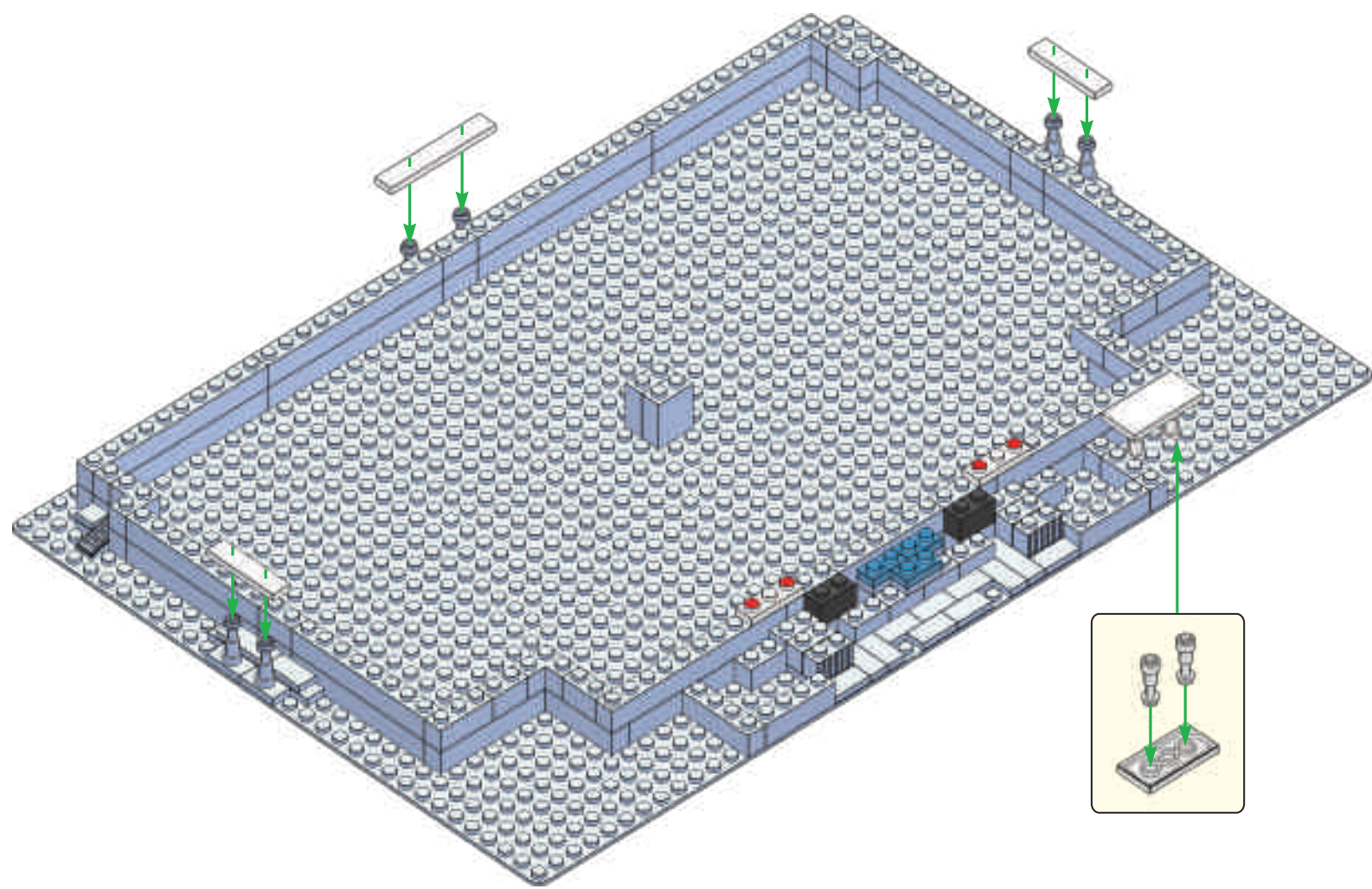

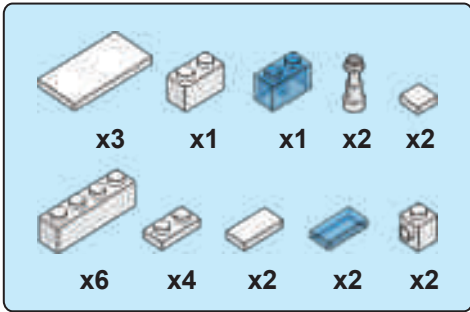

8

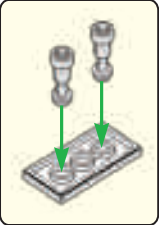
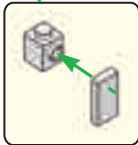
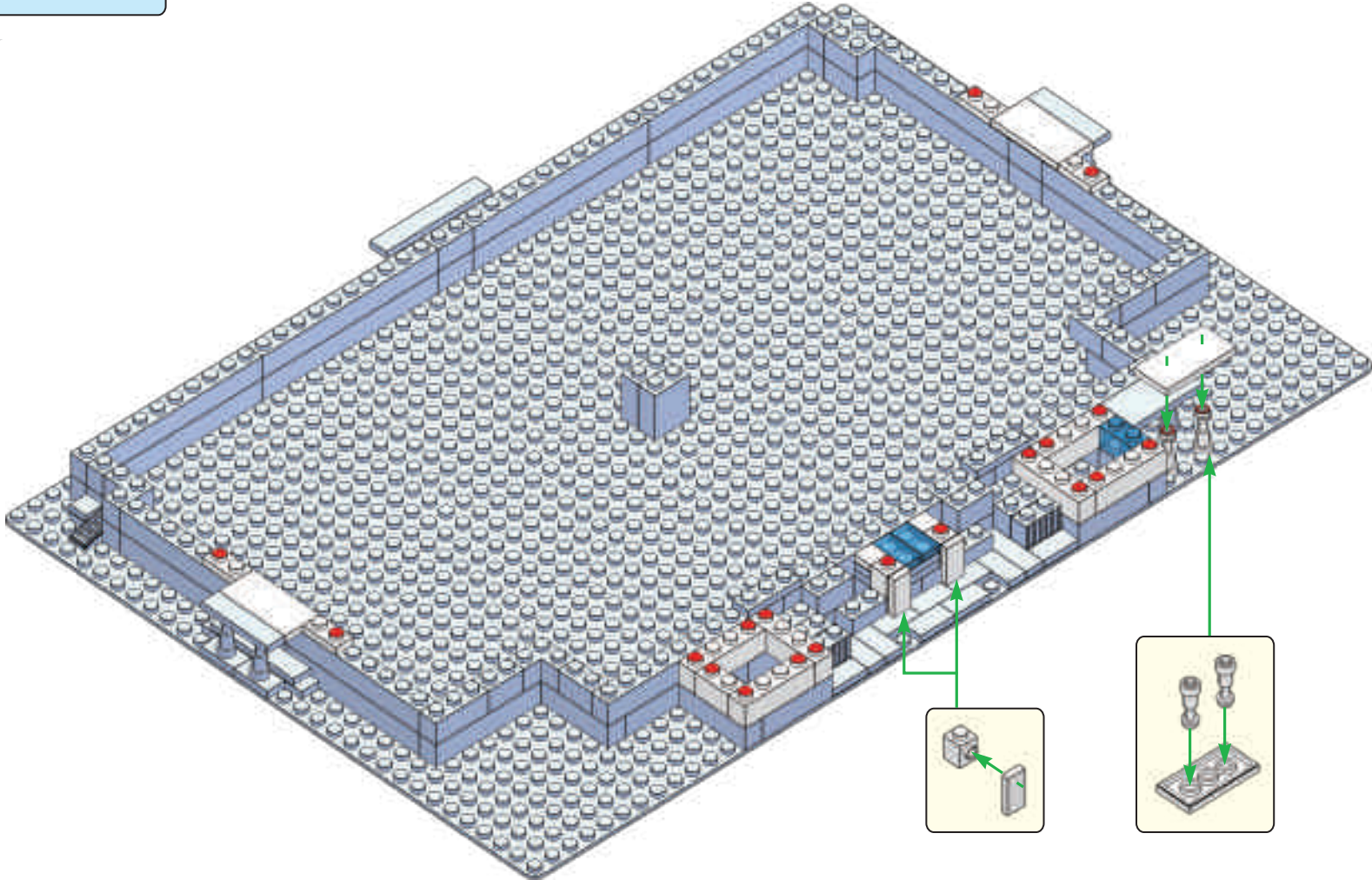

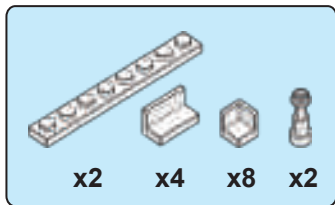

9

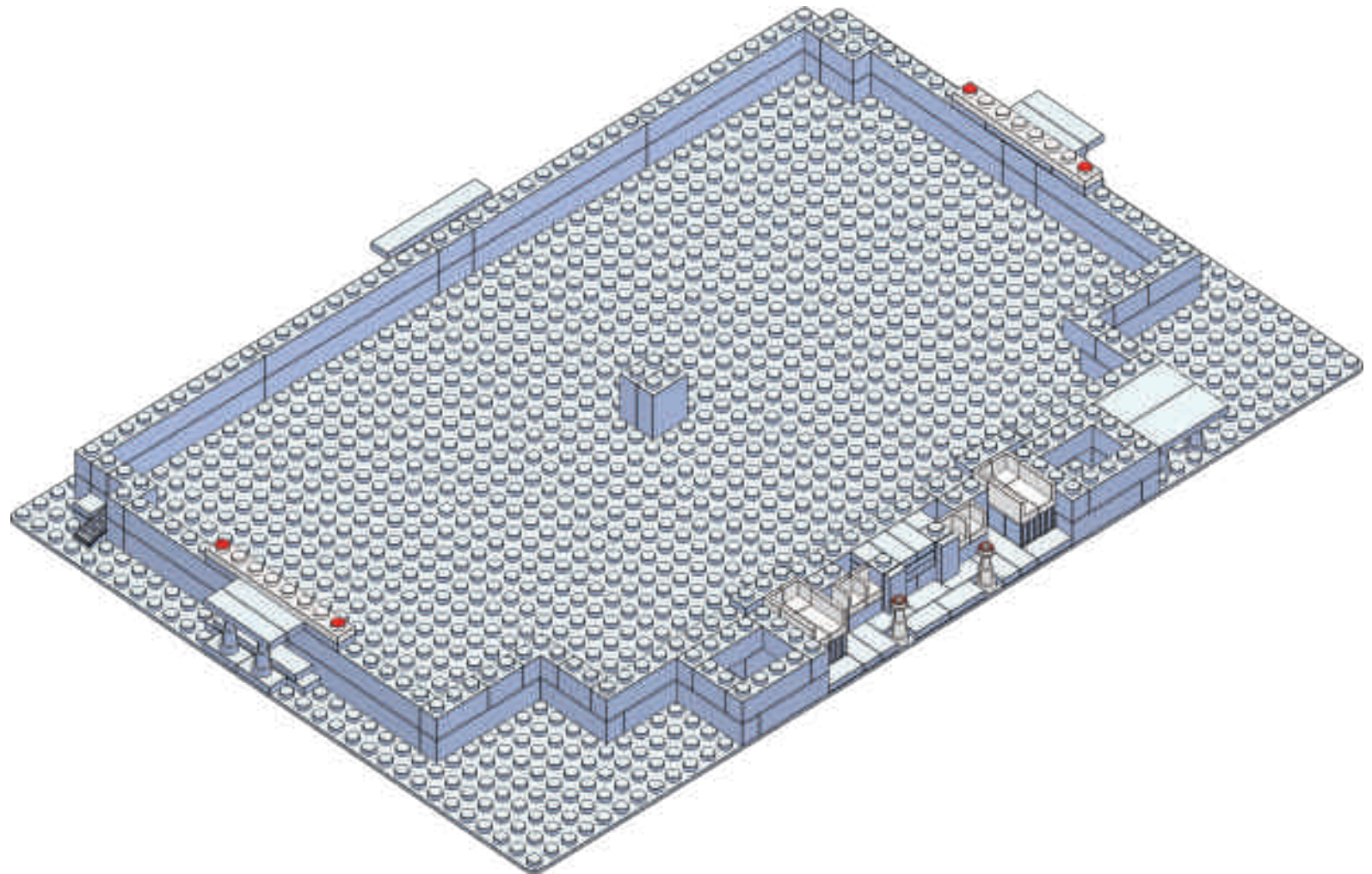

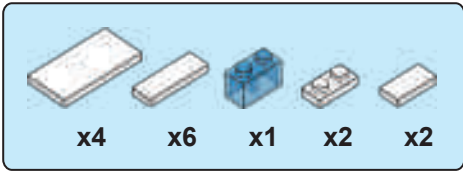

10

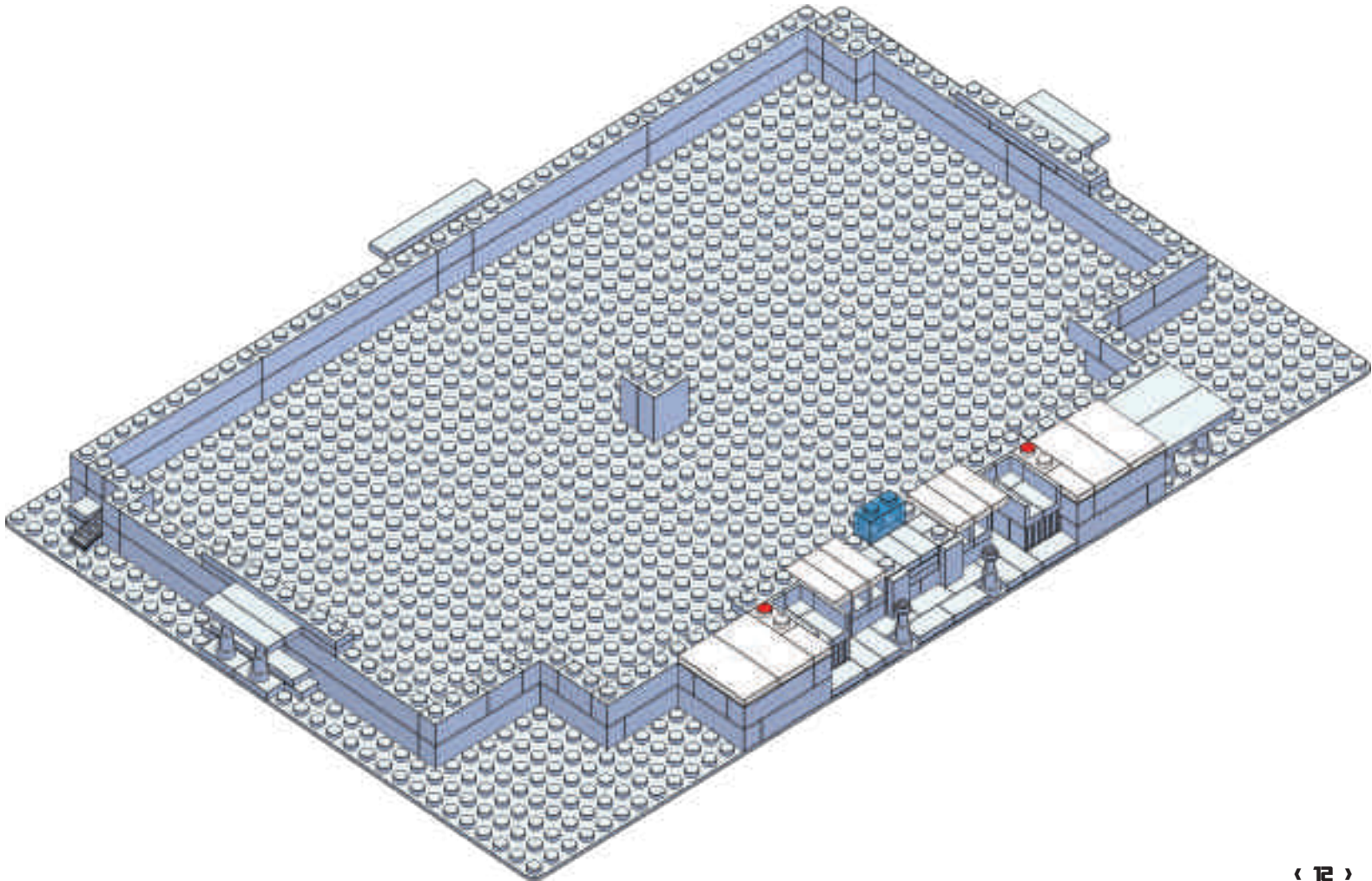



11

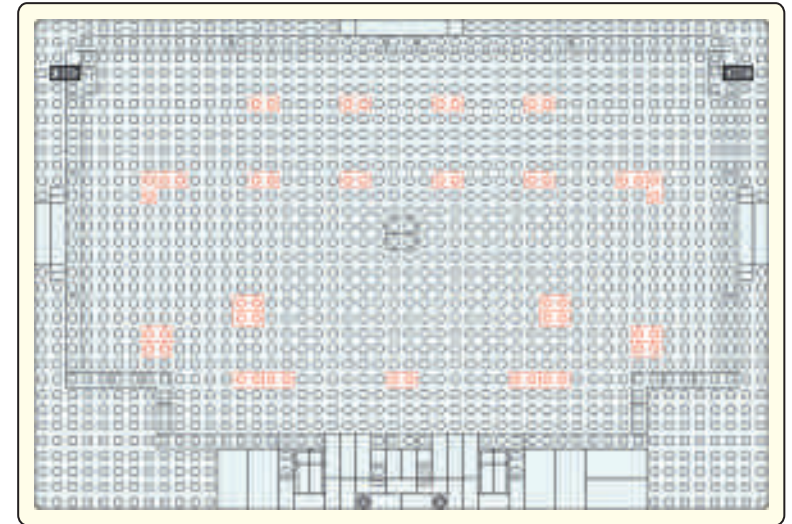
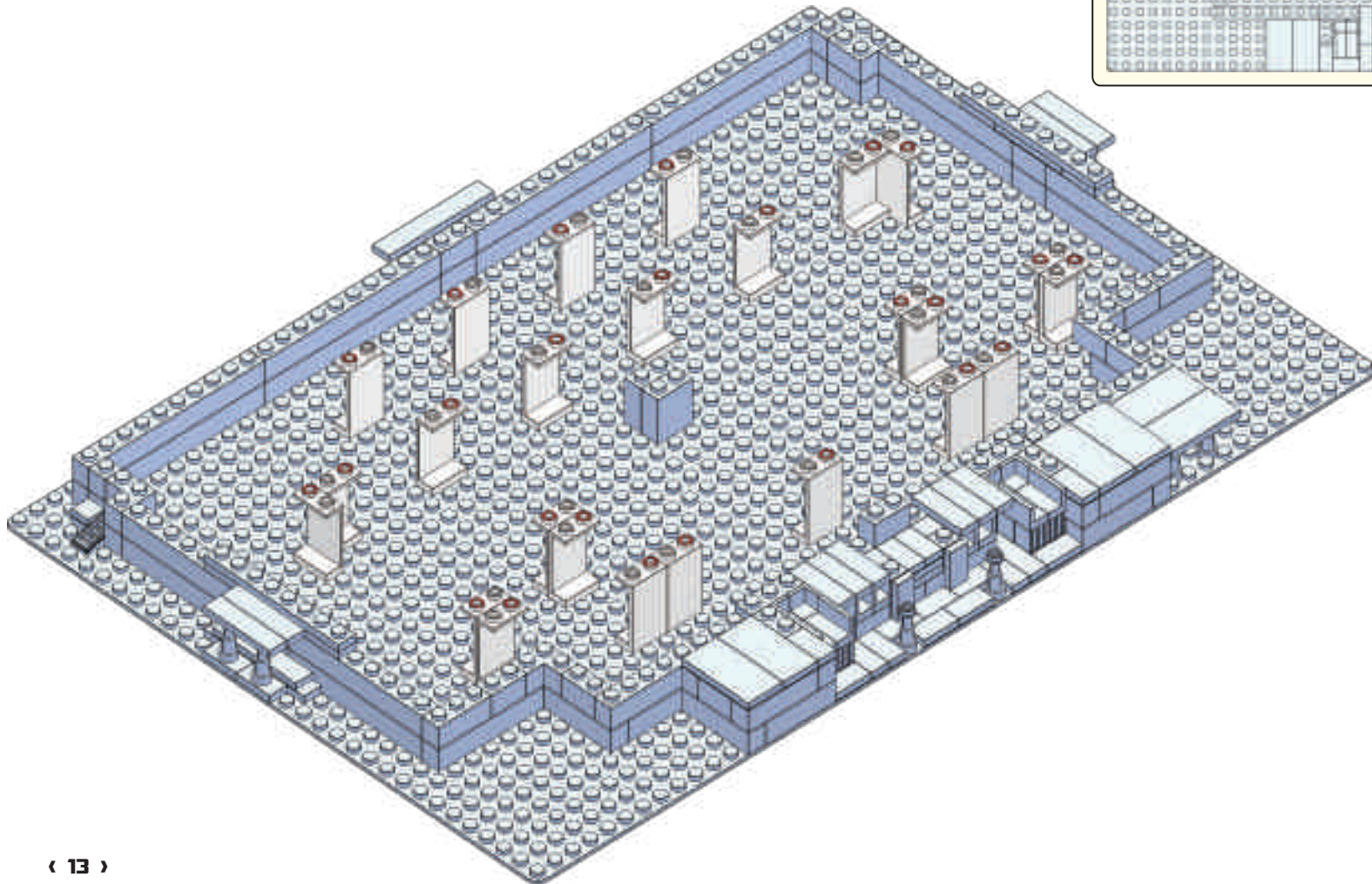

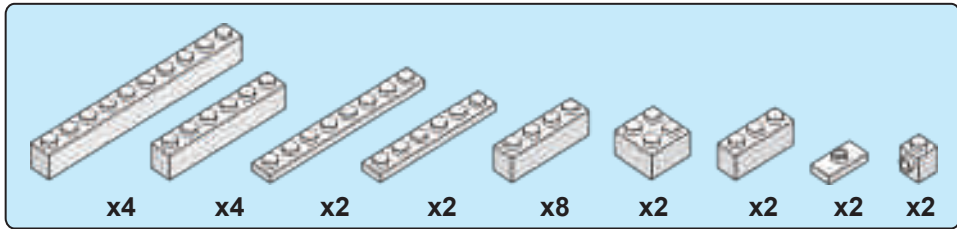

12

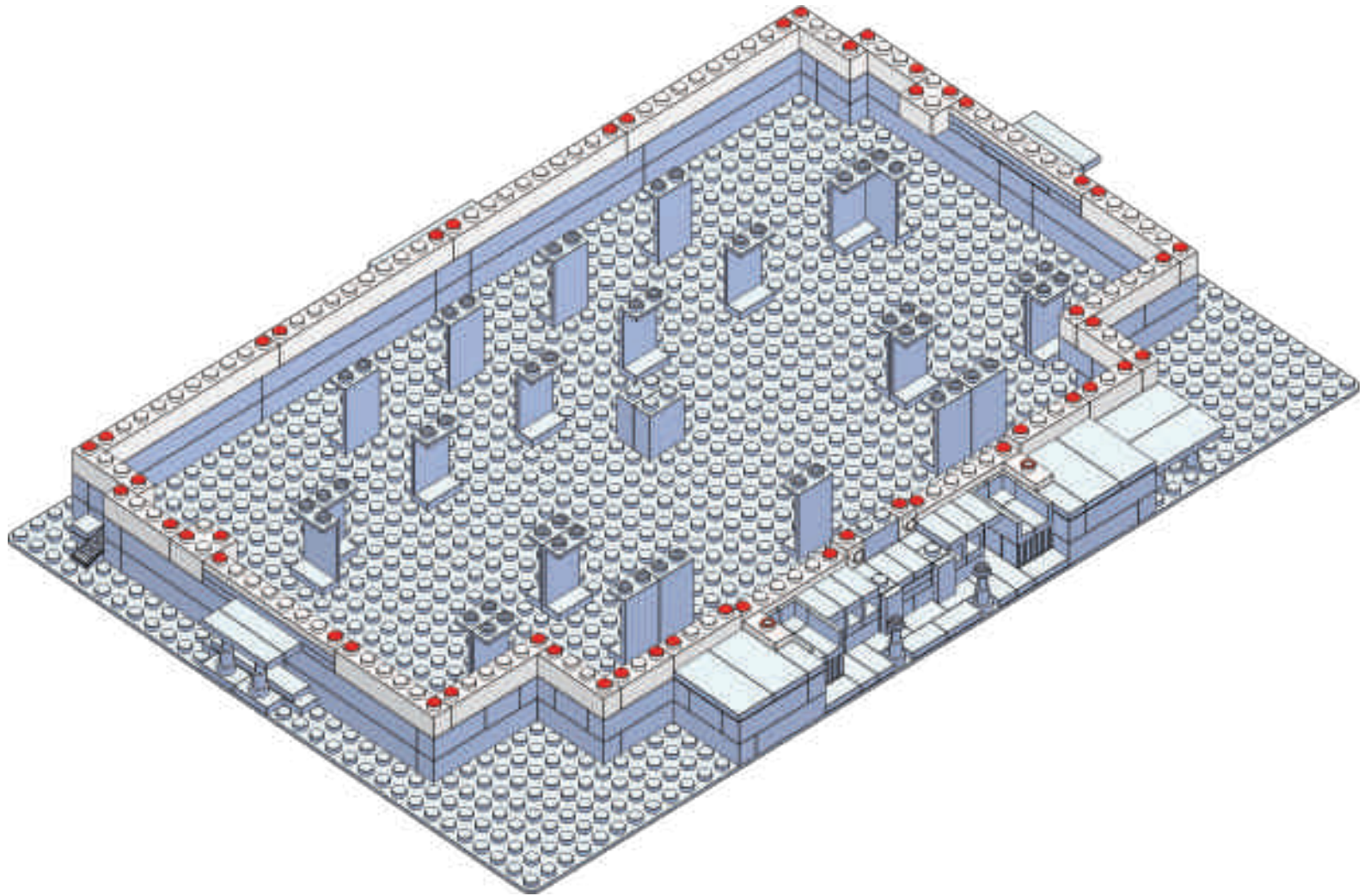

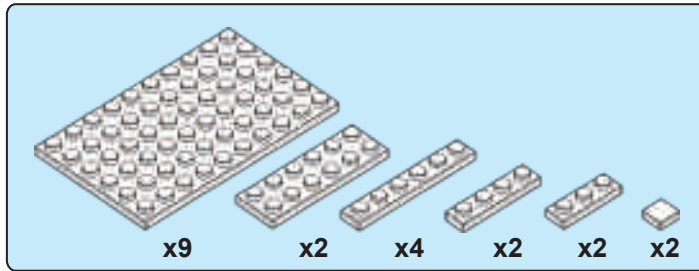

13

Please note: it is important to make sure the large flat plates are fully clicked to all corners of pieces underneath.

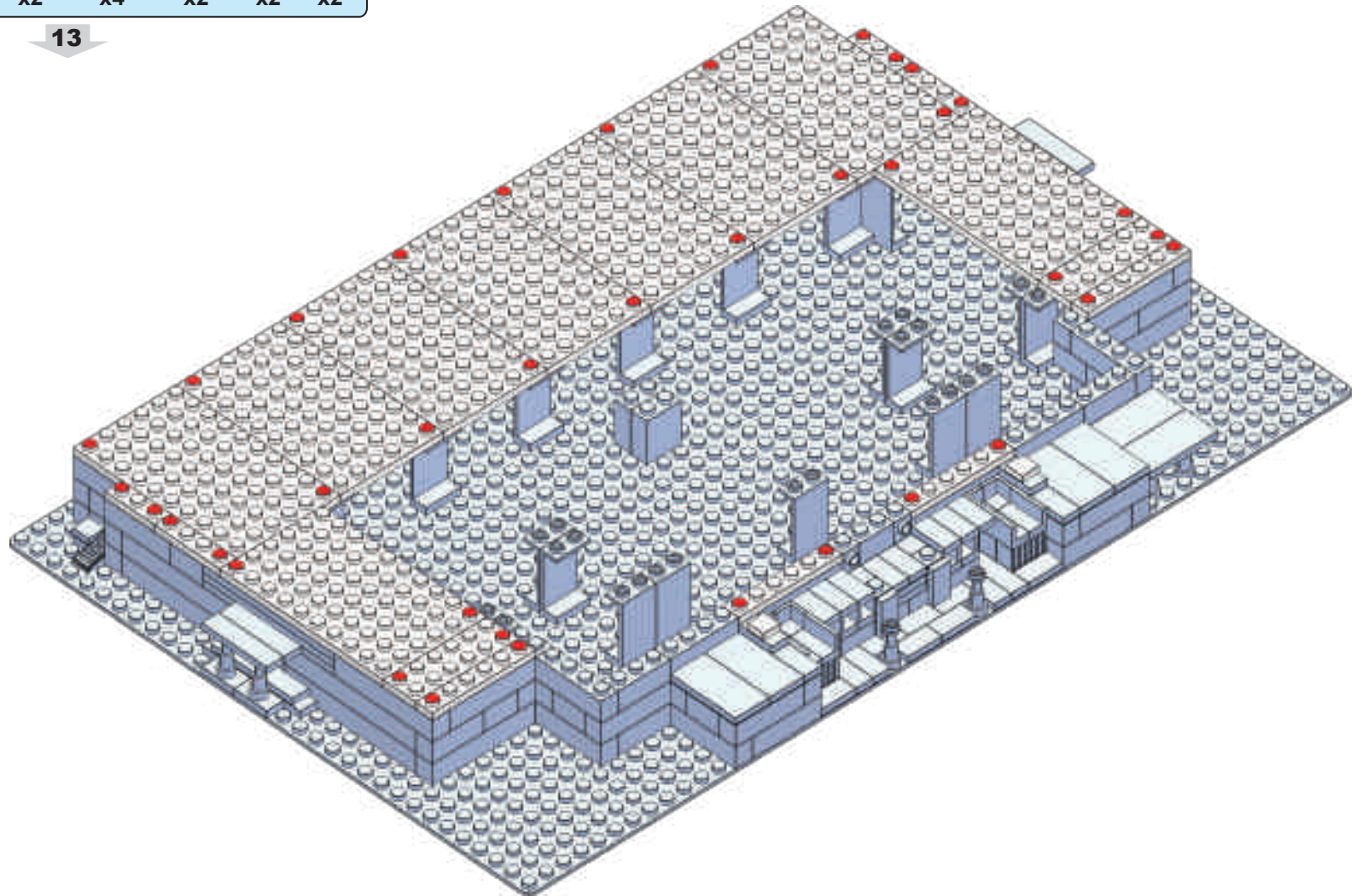

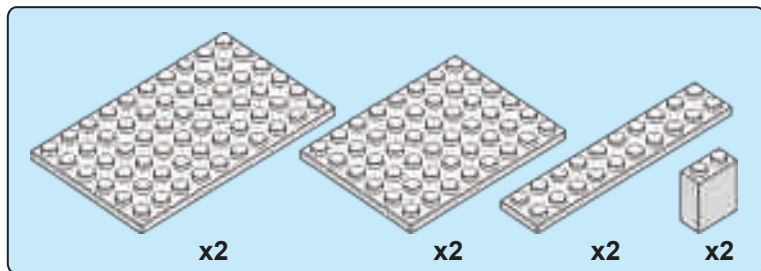

14

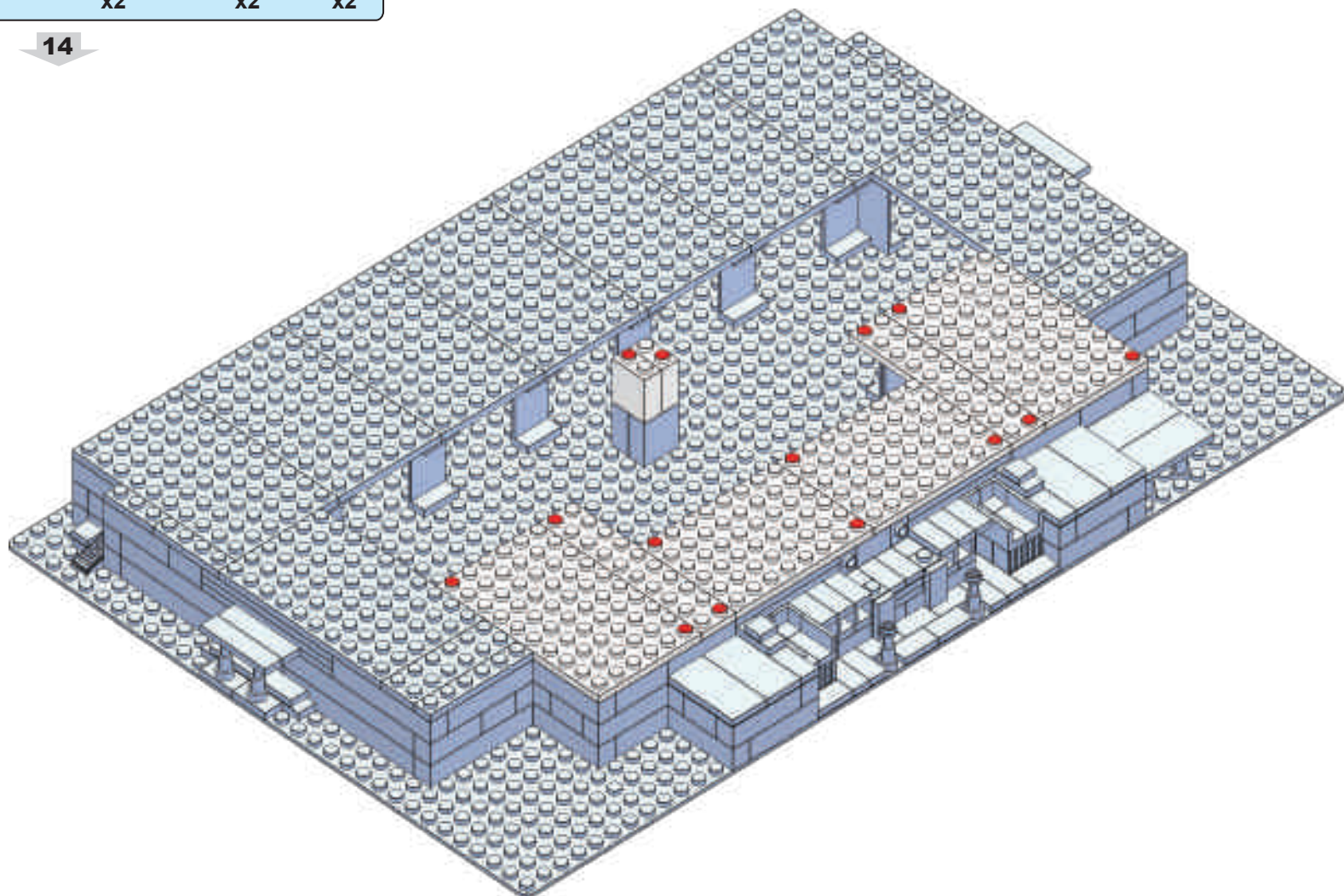

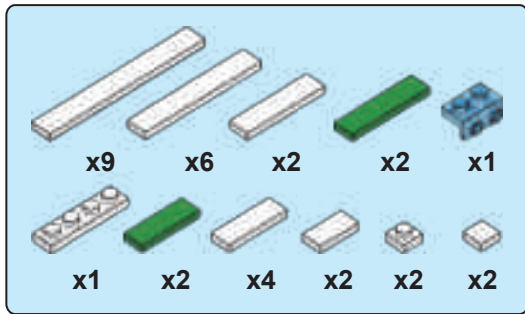

15

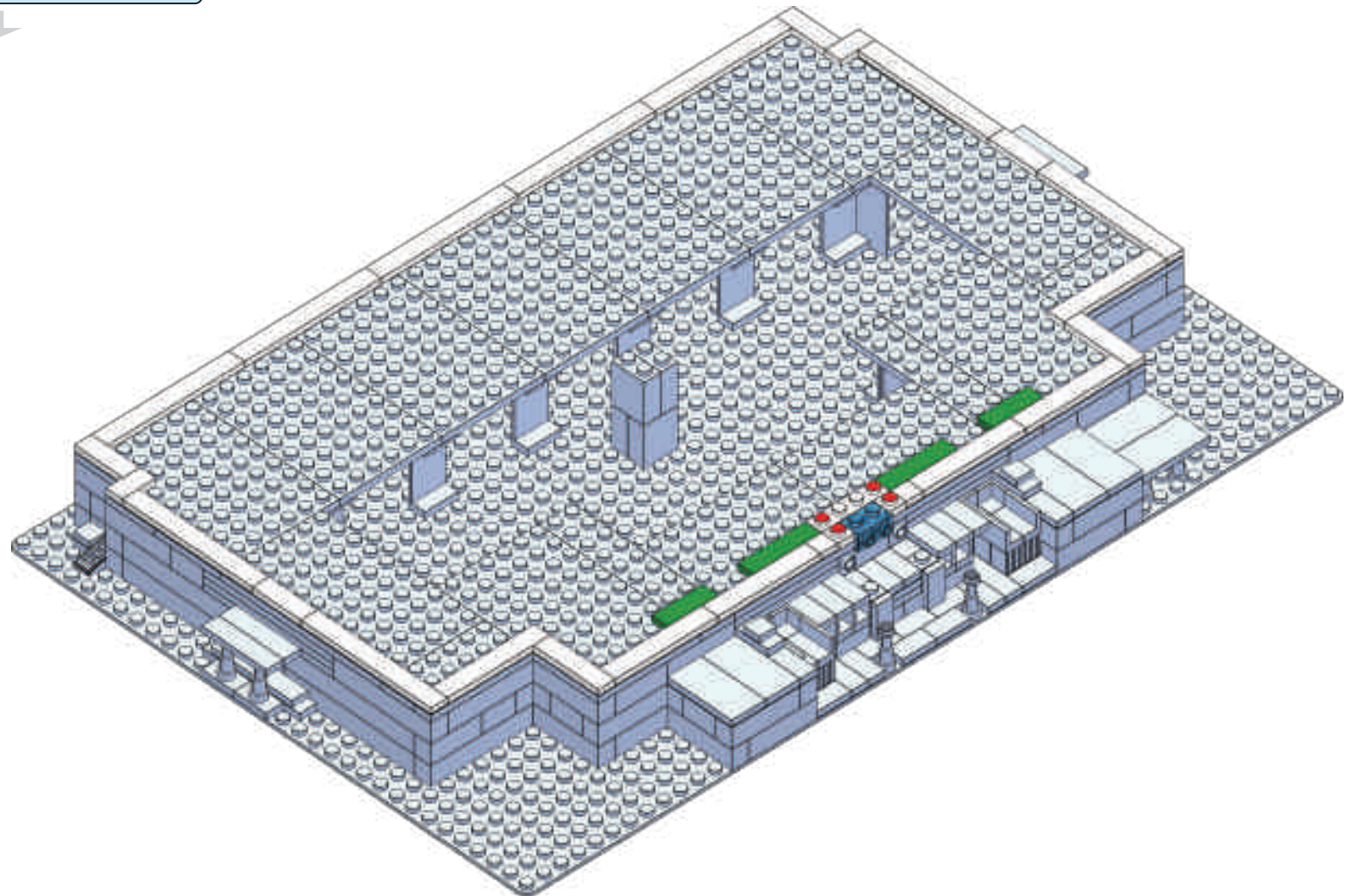

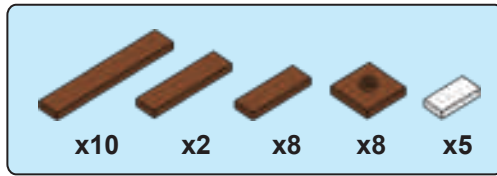

16

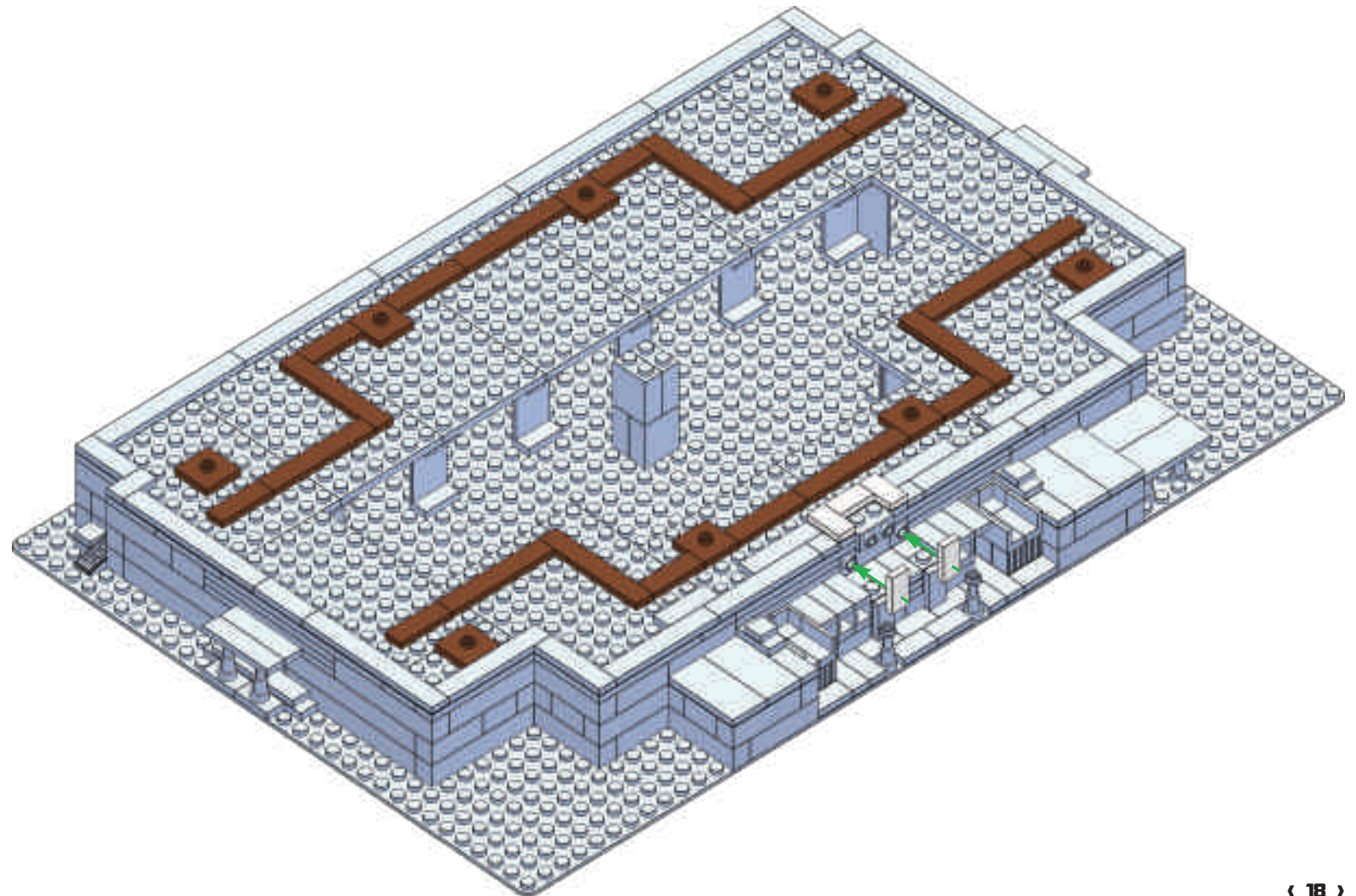

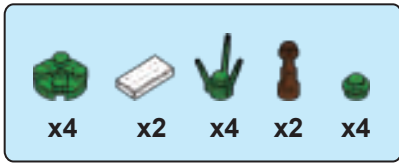

17

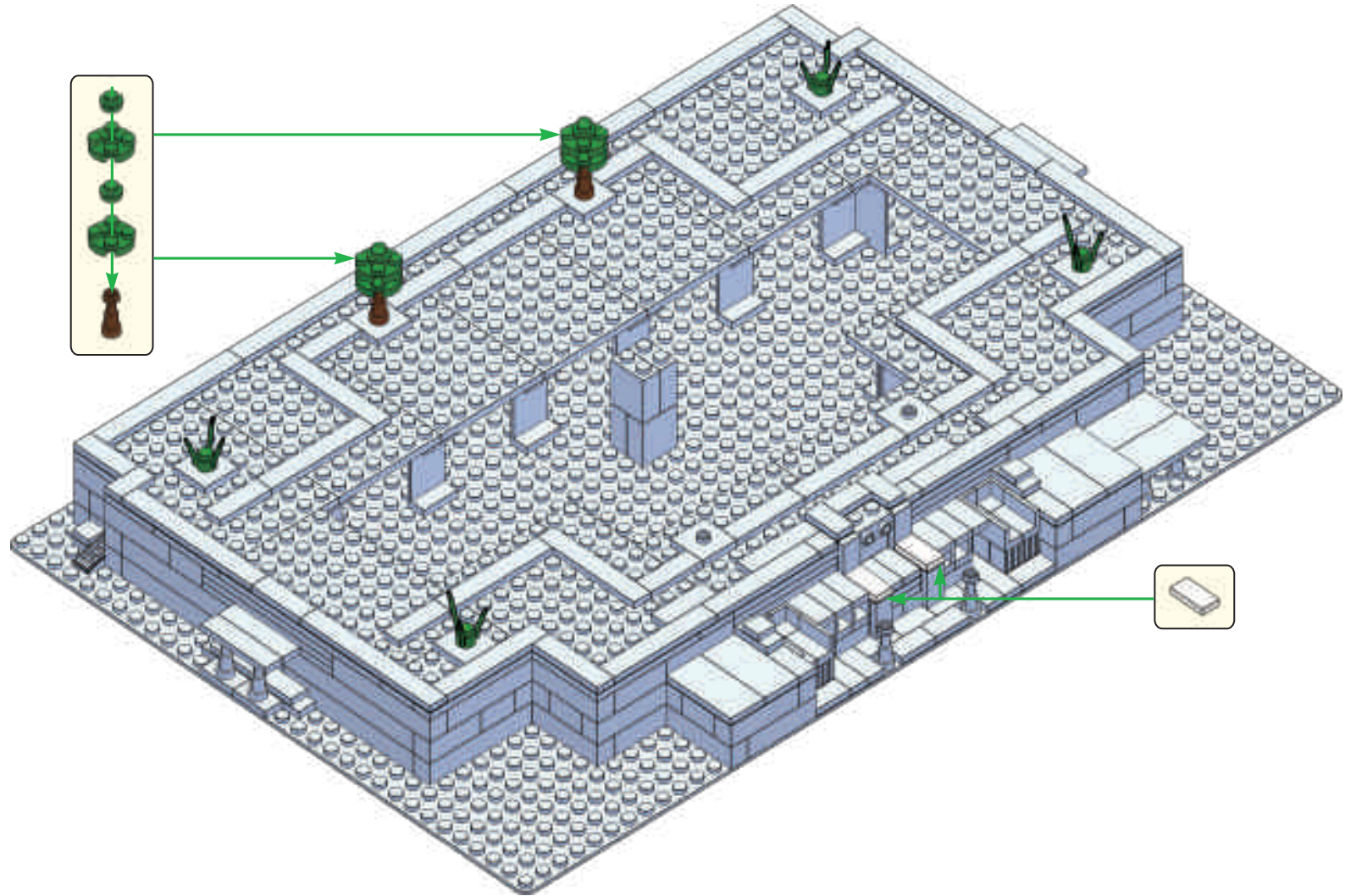

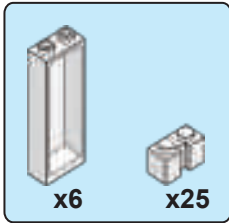

18

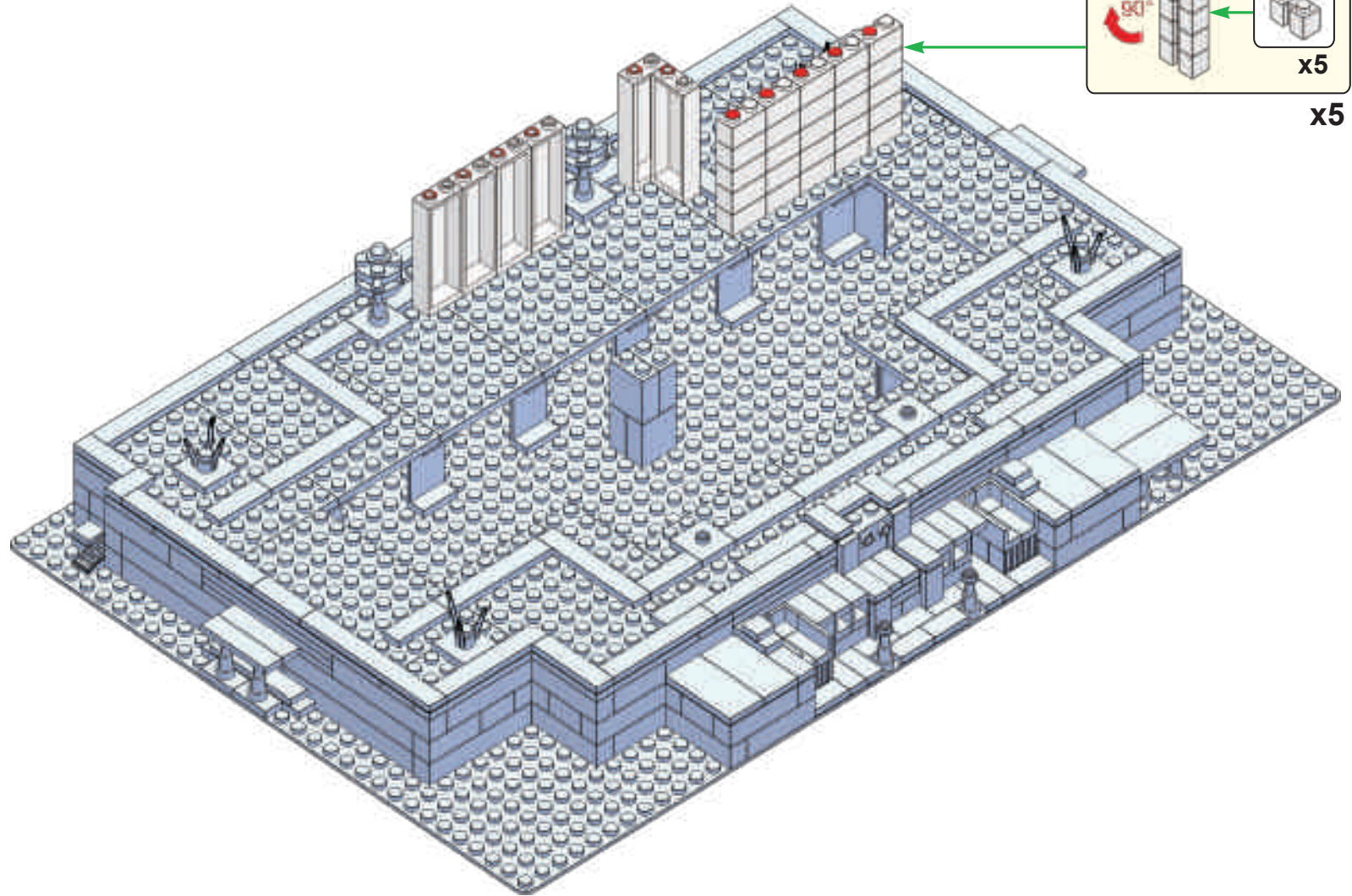

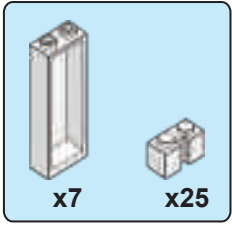

19

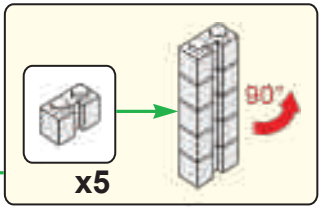
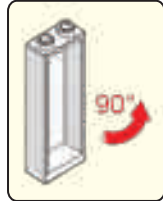

x5

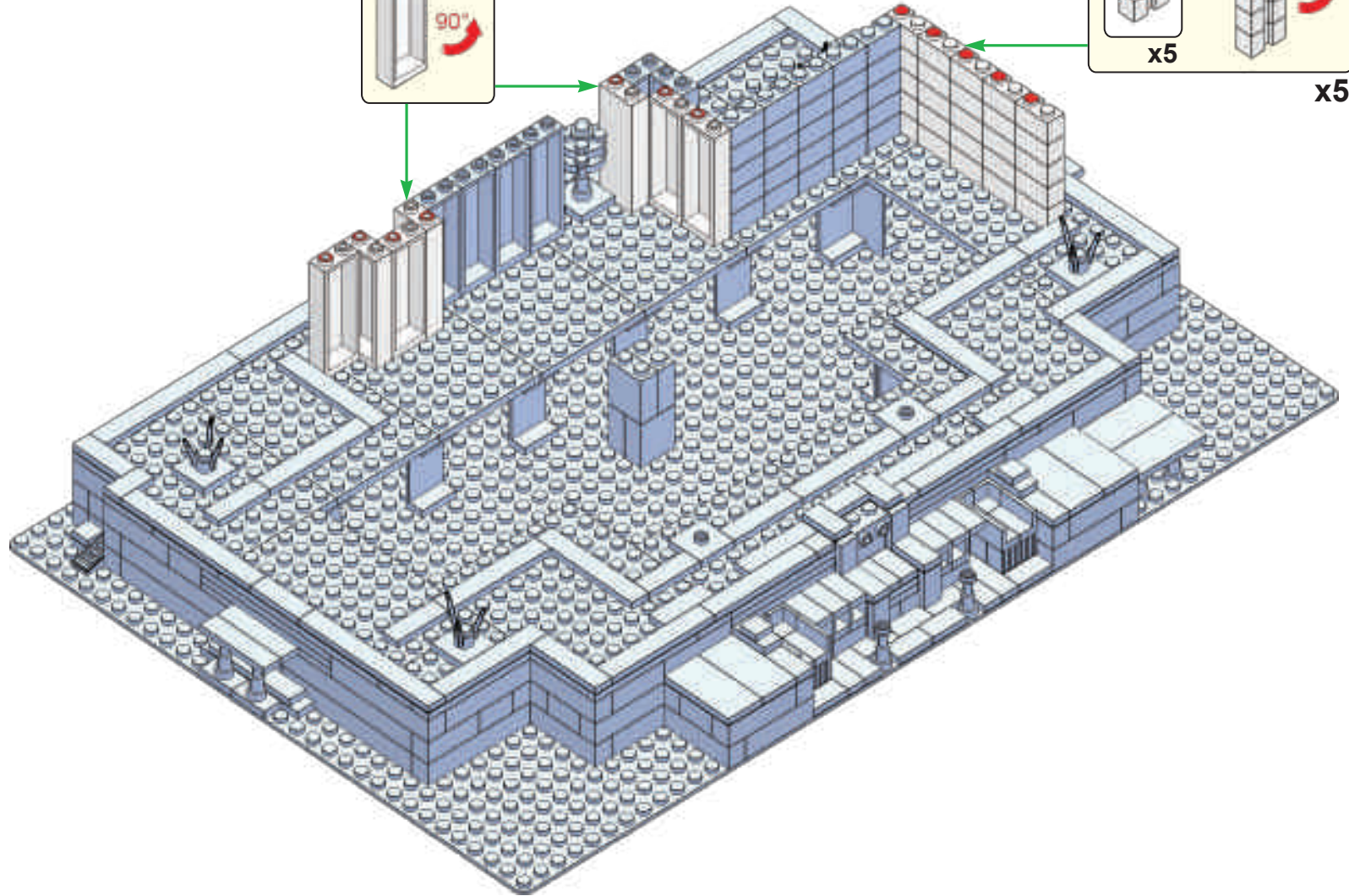

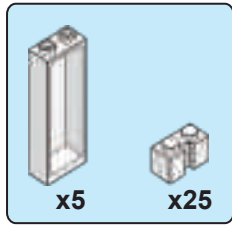

20

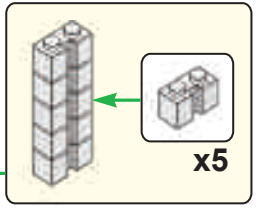
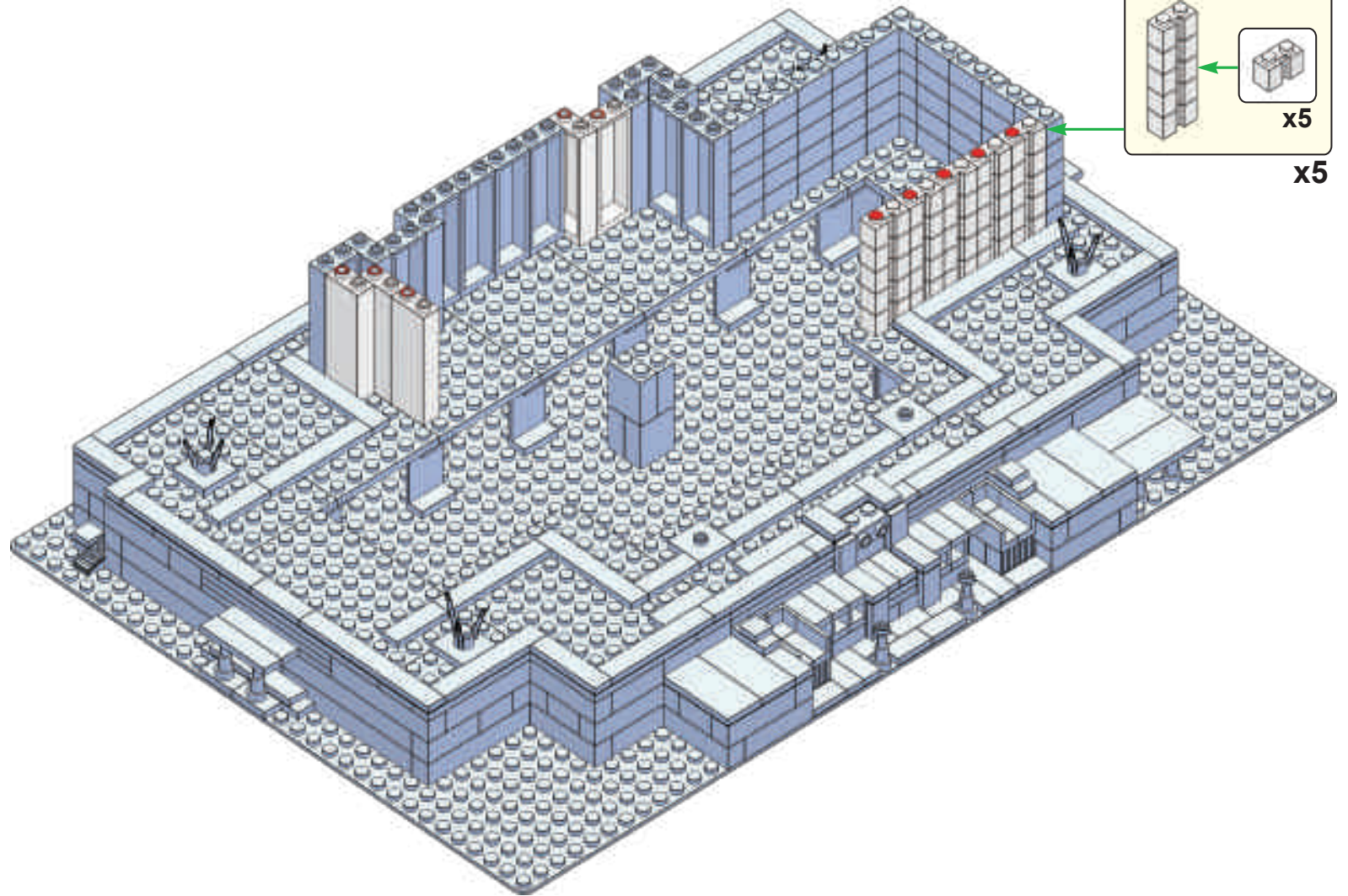

x5
x5

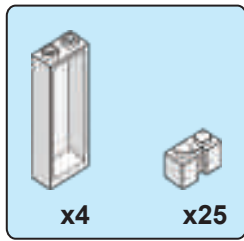

21

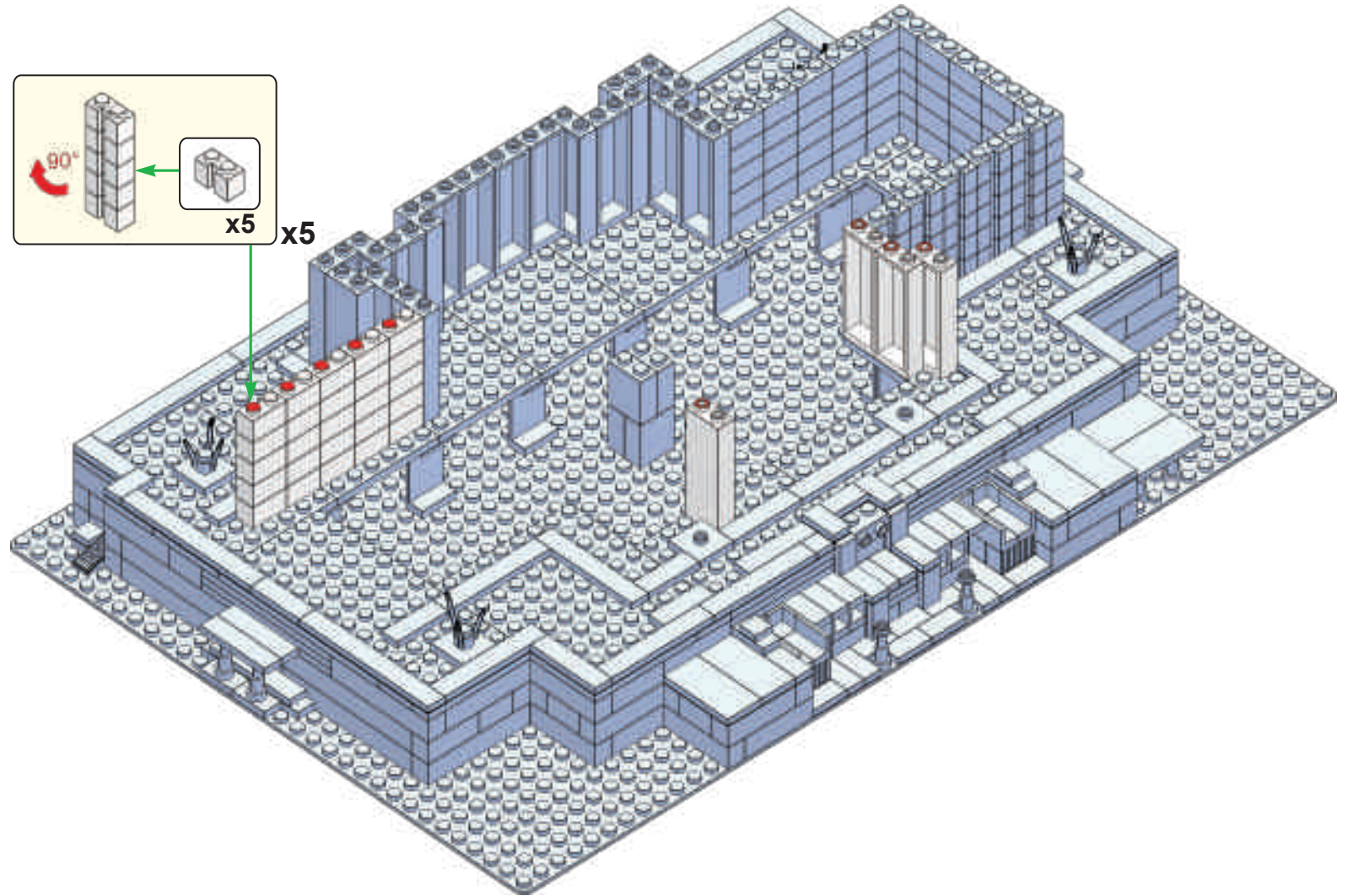
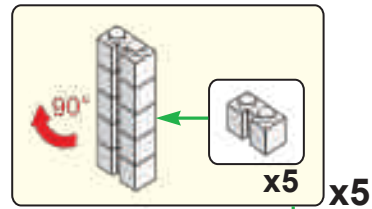

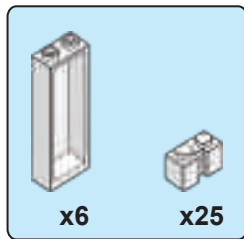

22

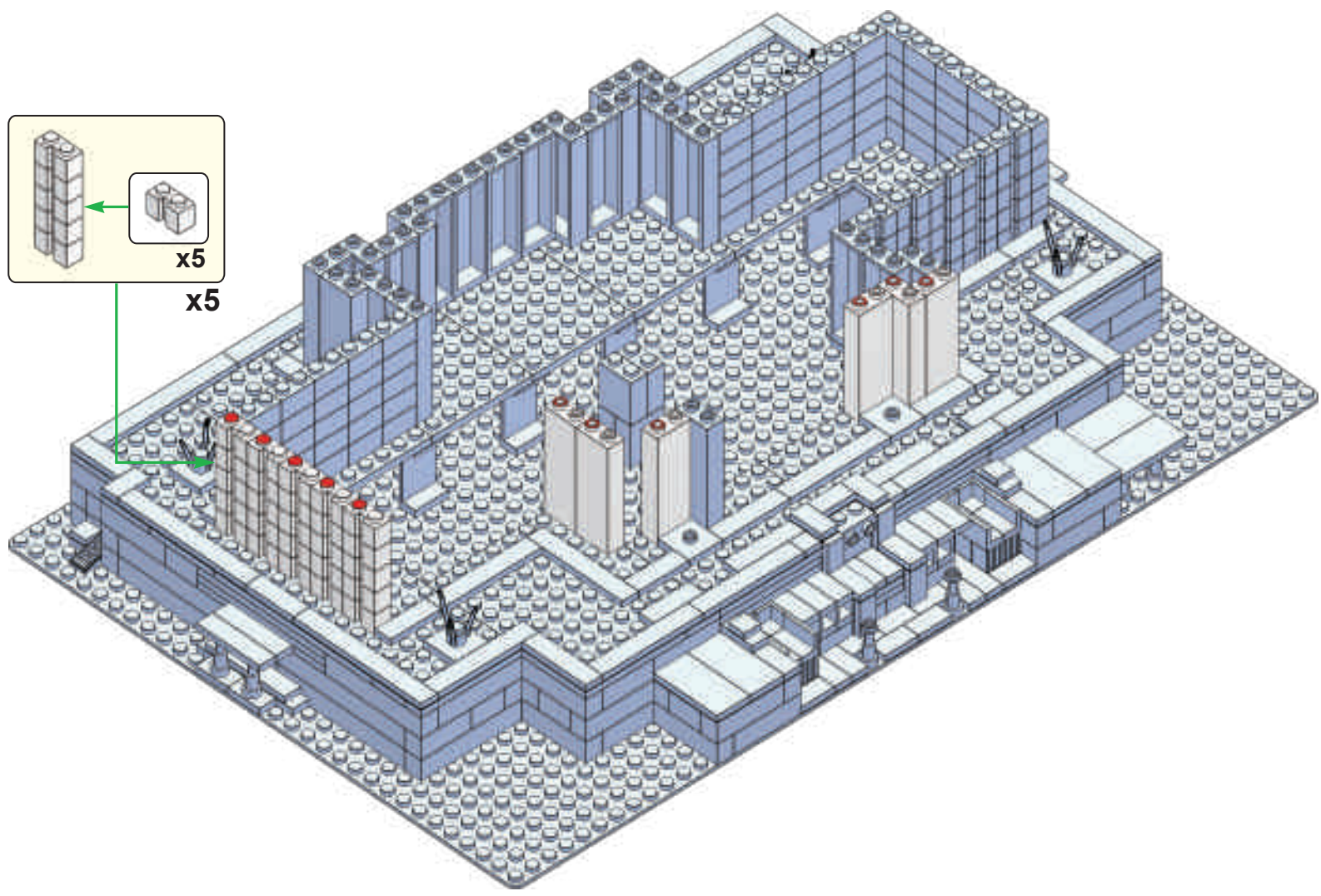
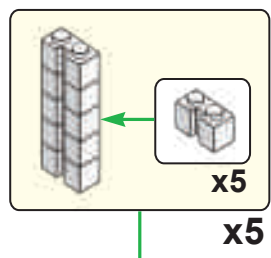

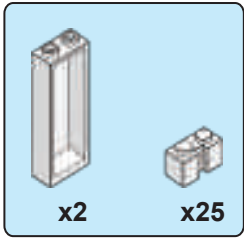

23

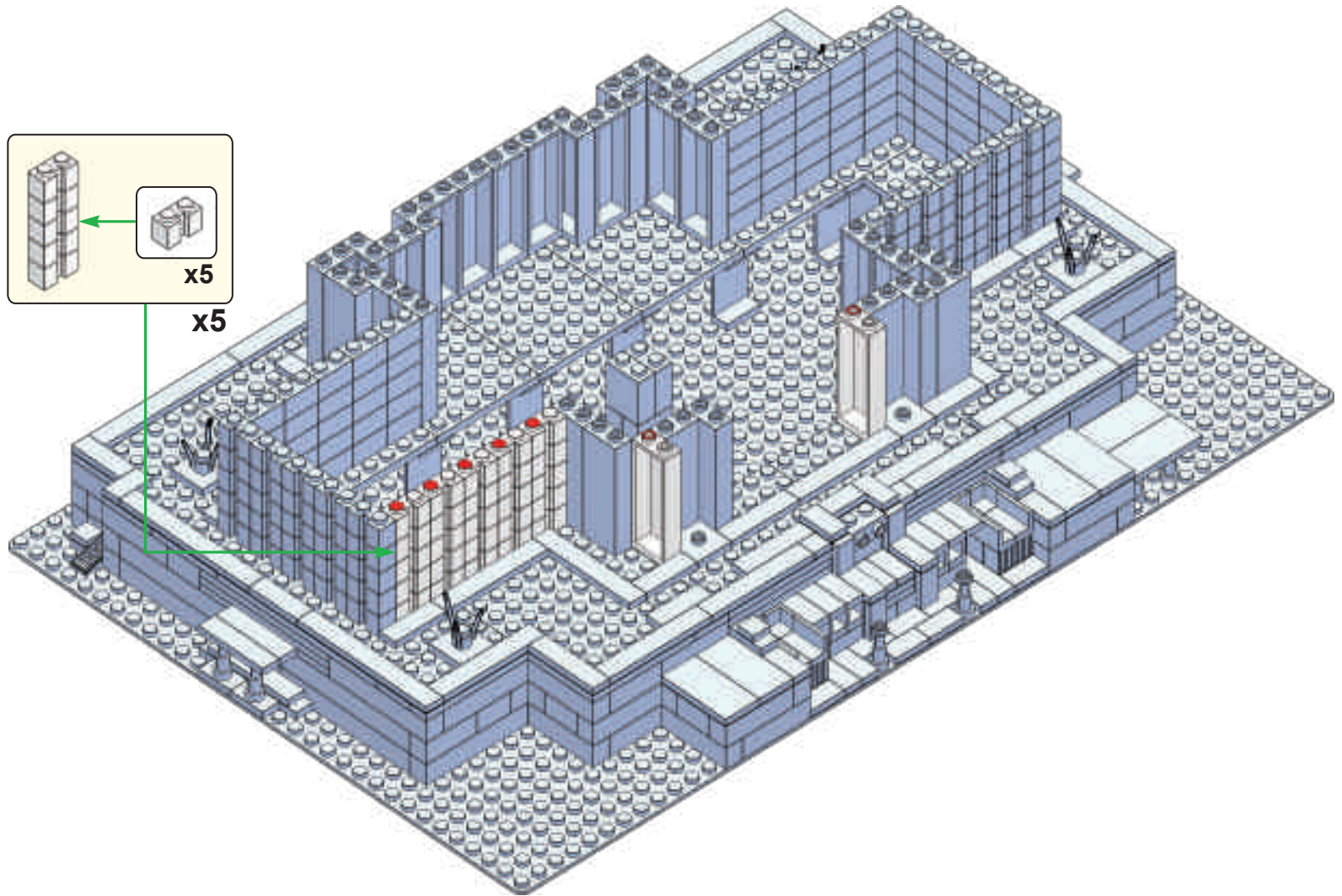

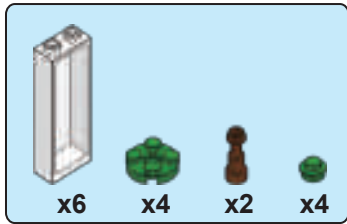

24

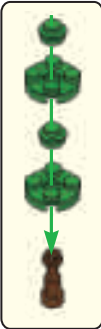
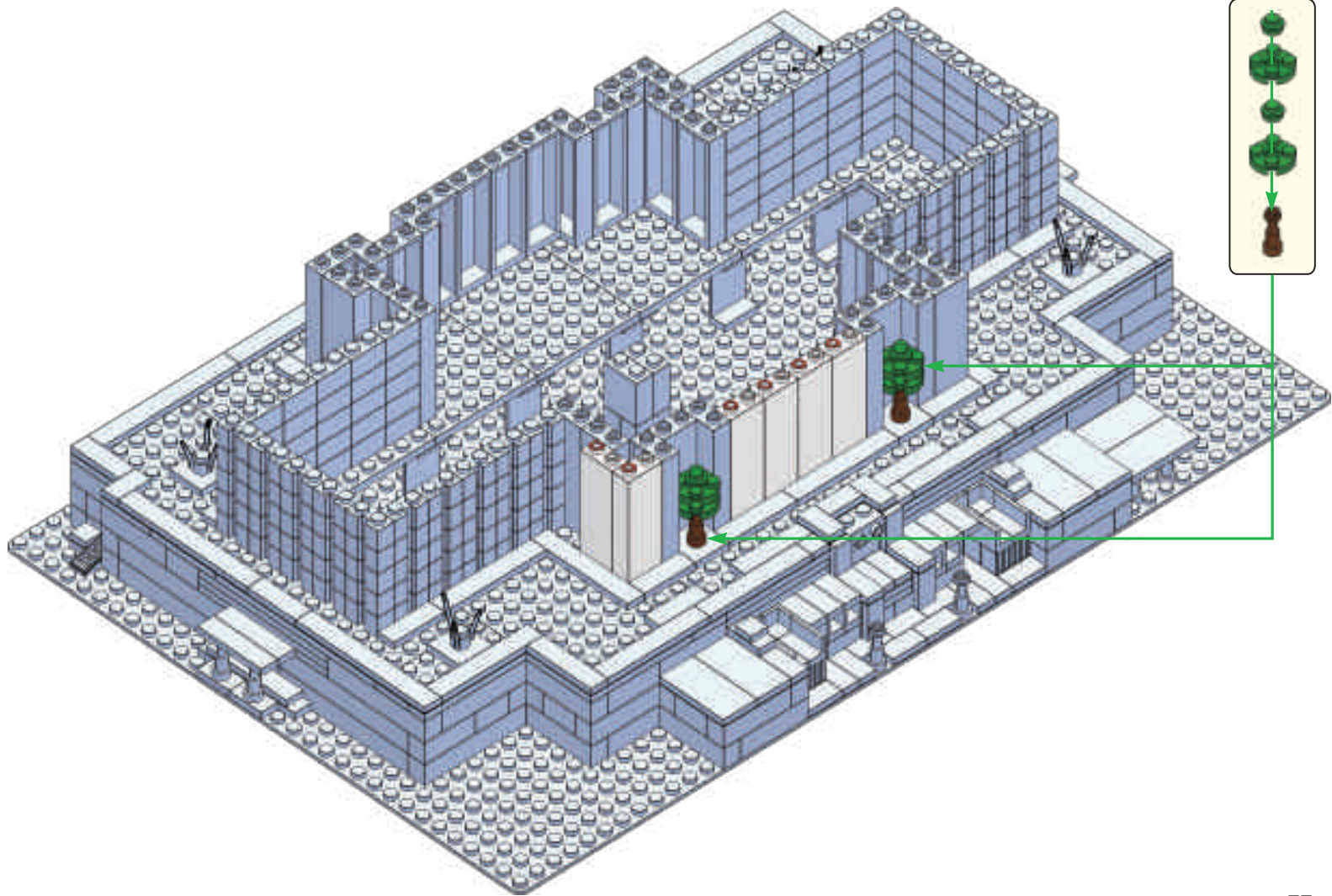

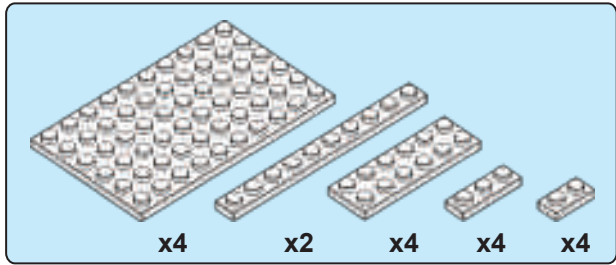

25

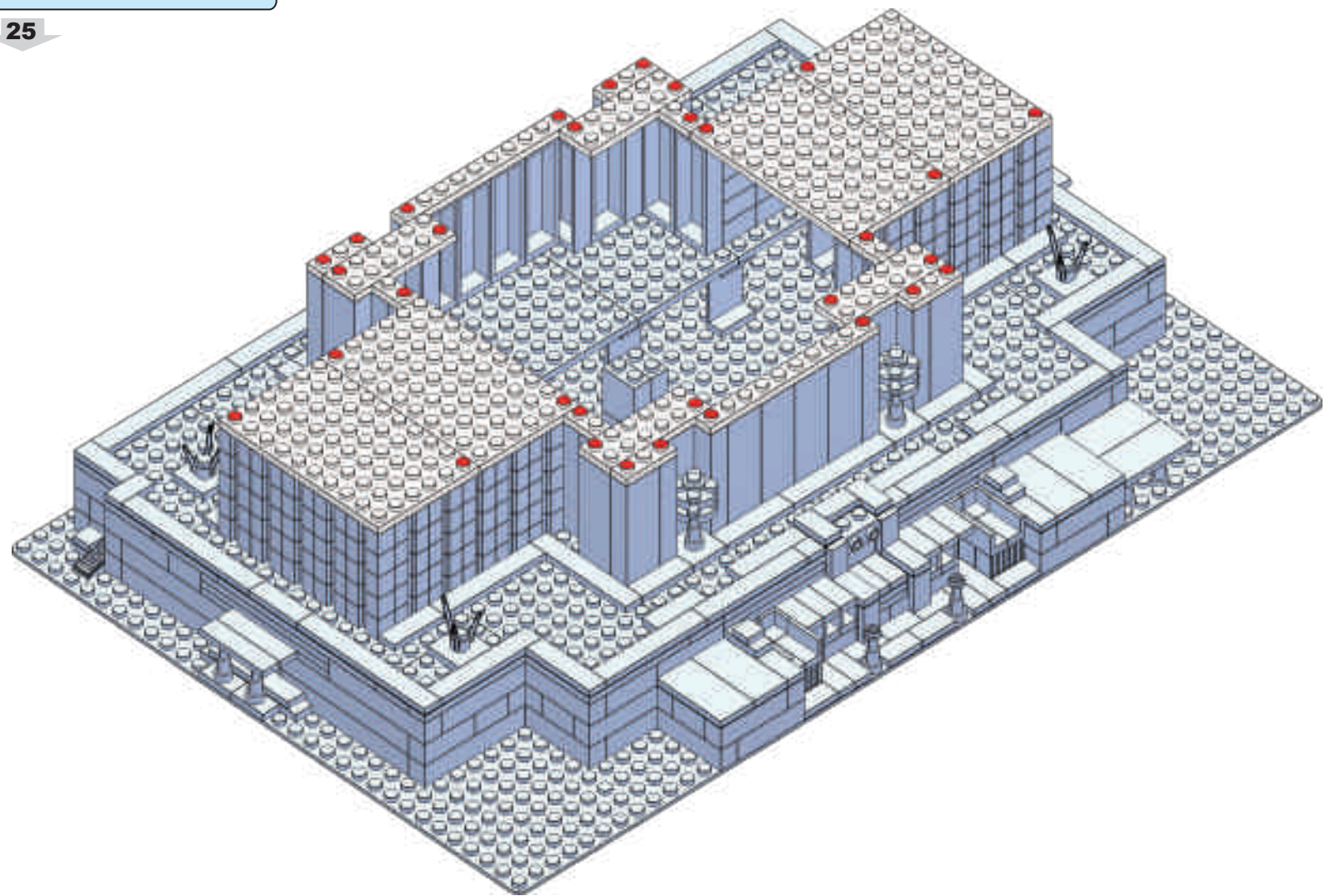

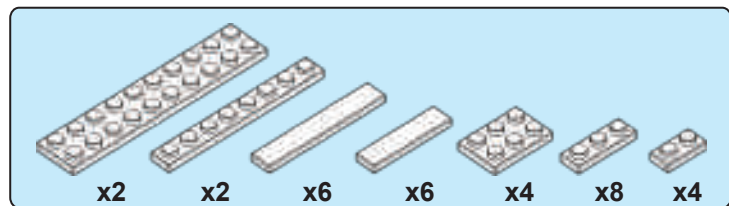

26

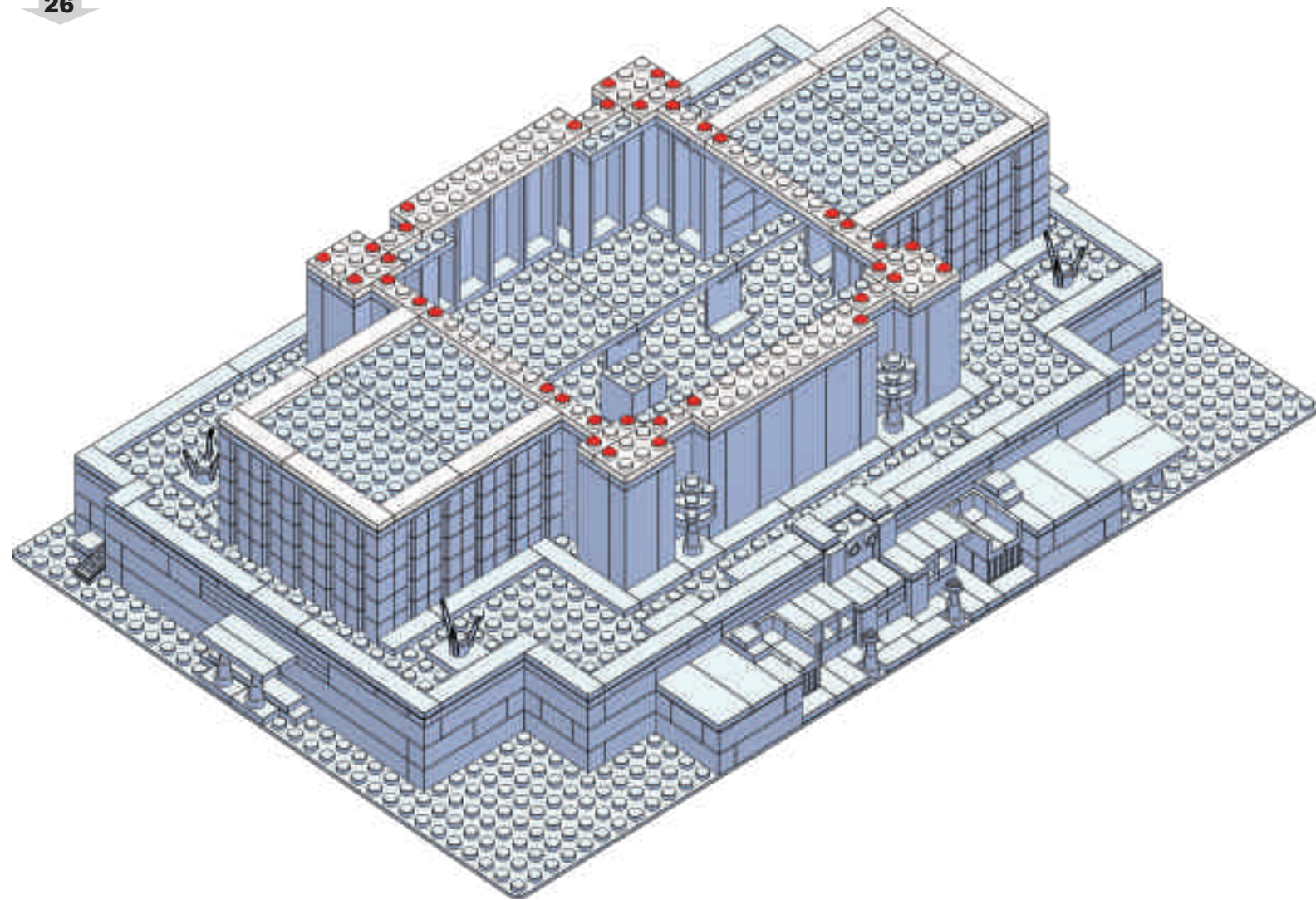

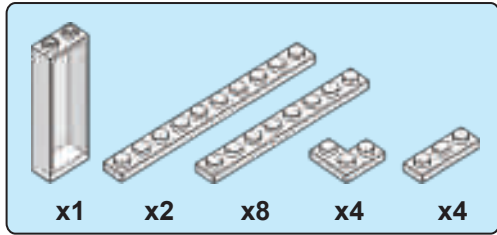

27

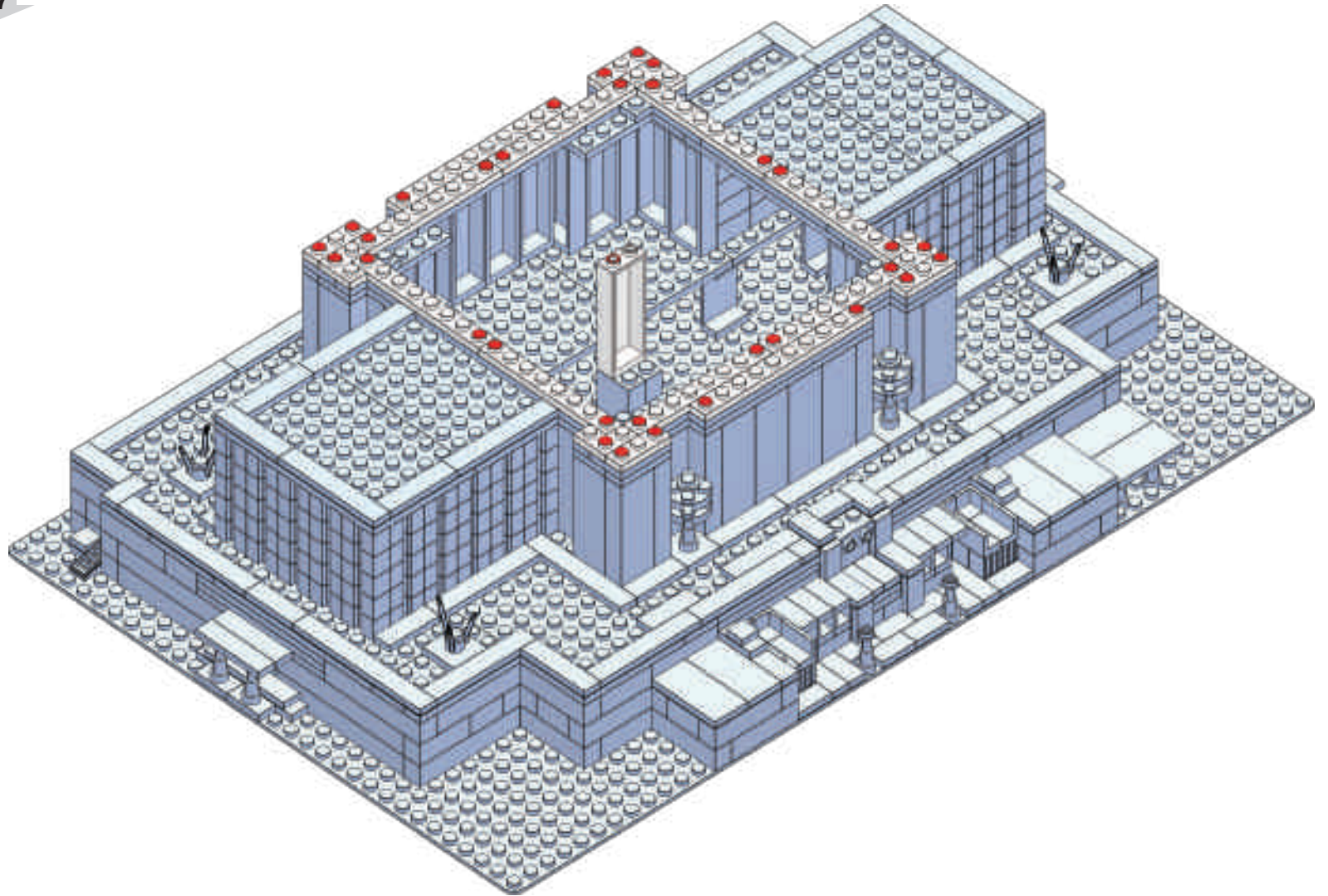

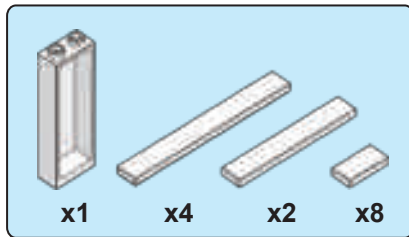

28

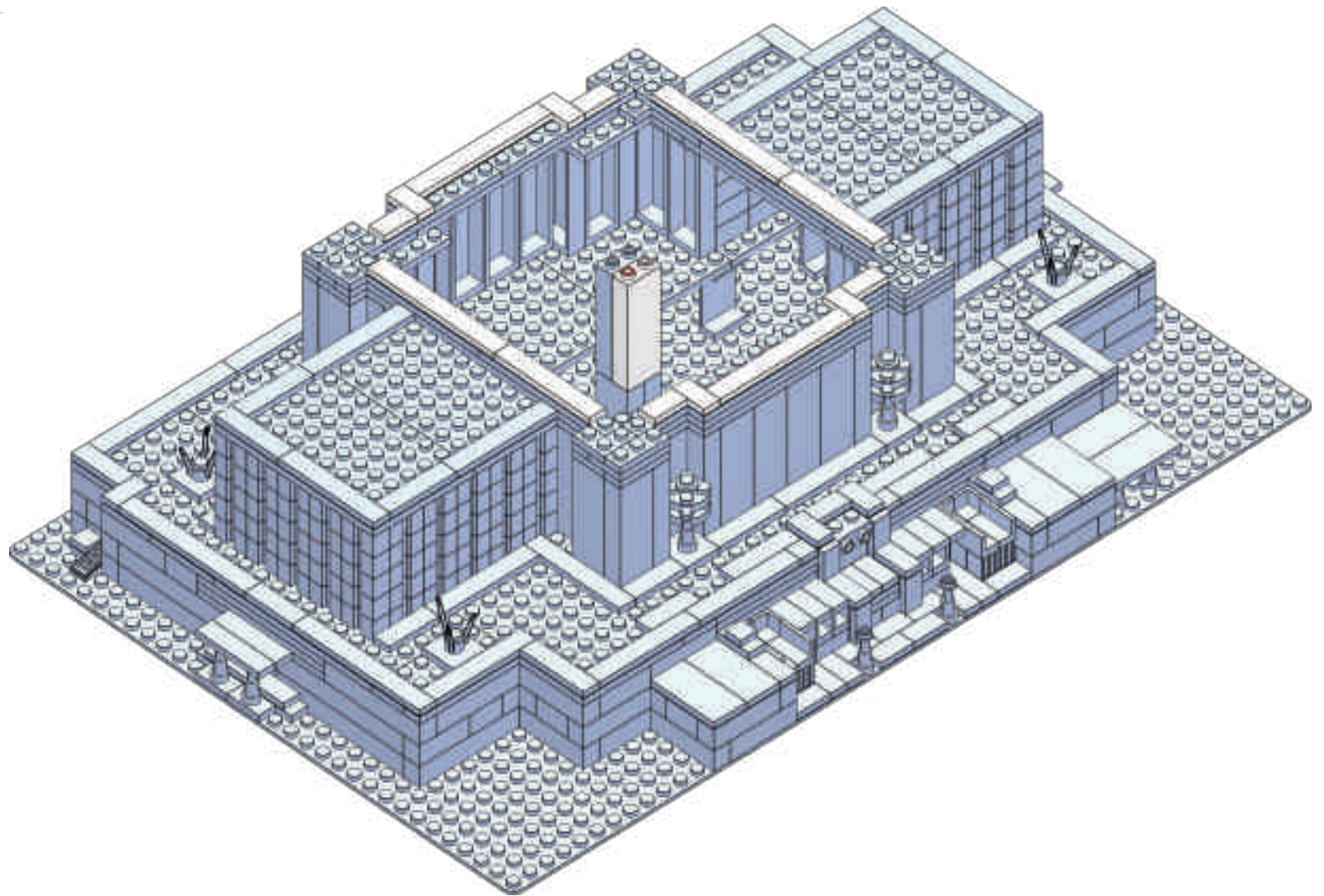

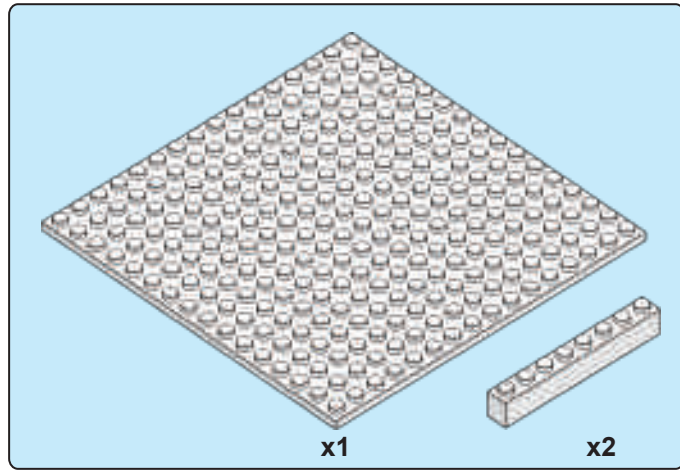

29

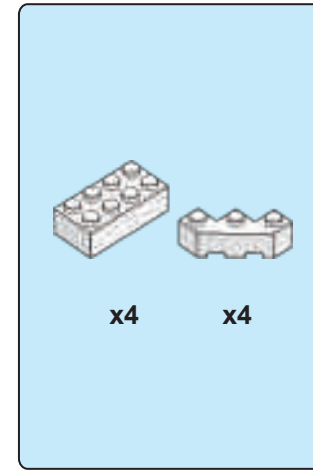
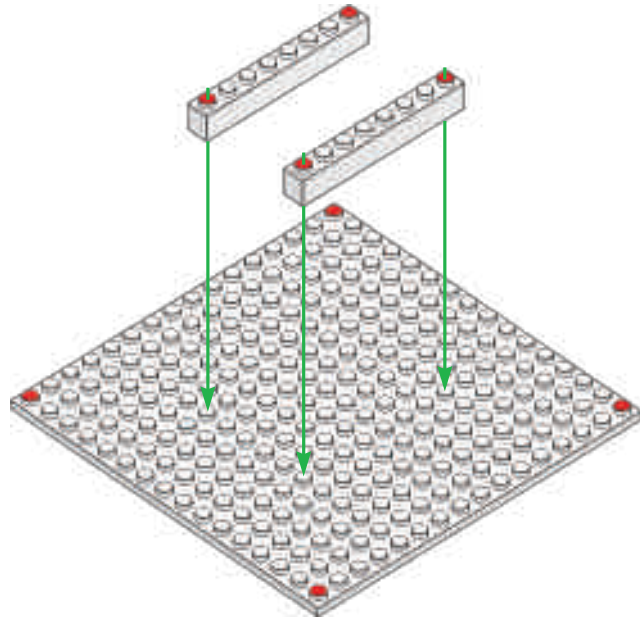

30

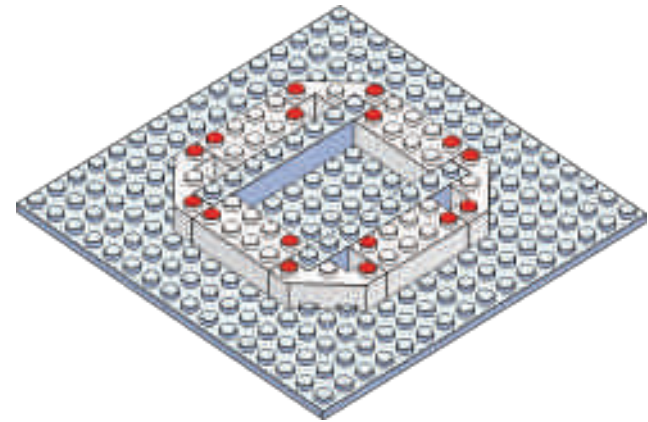

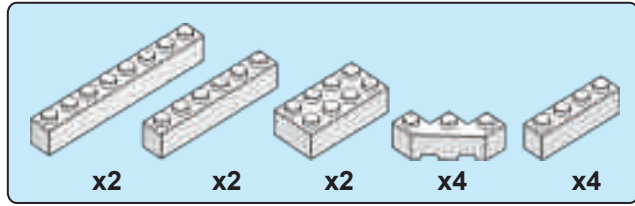

31

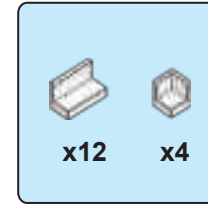
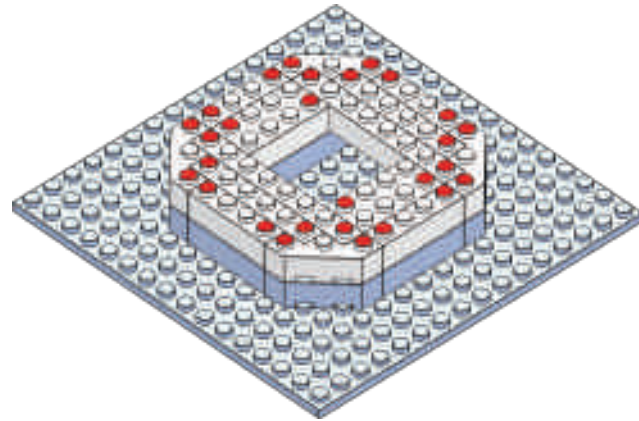

32

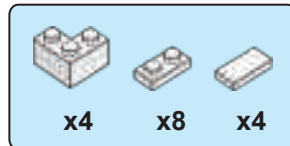
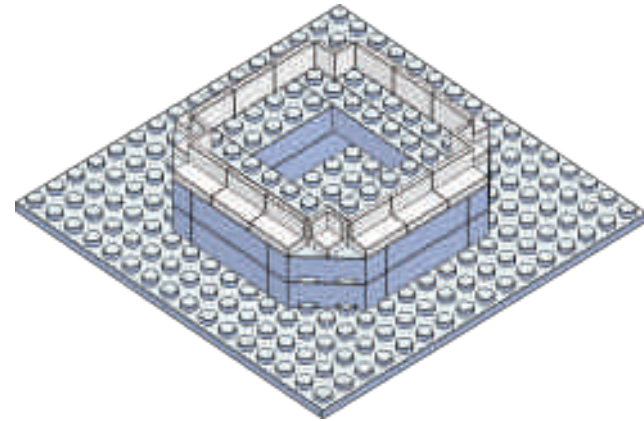

33

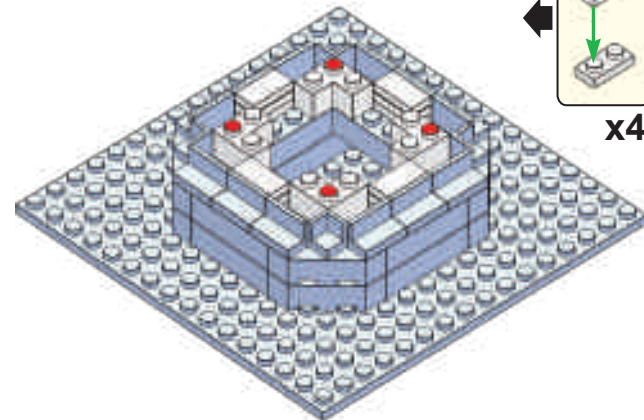

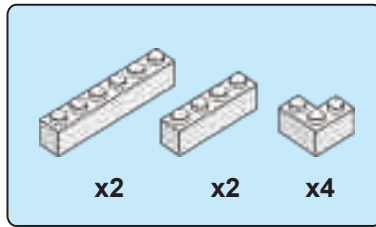

34

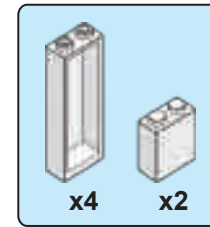

35

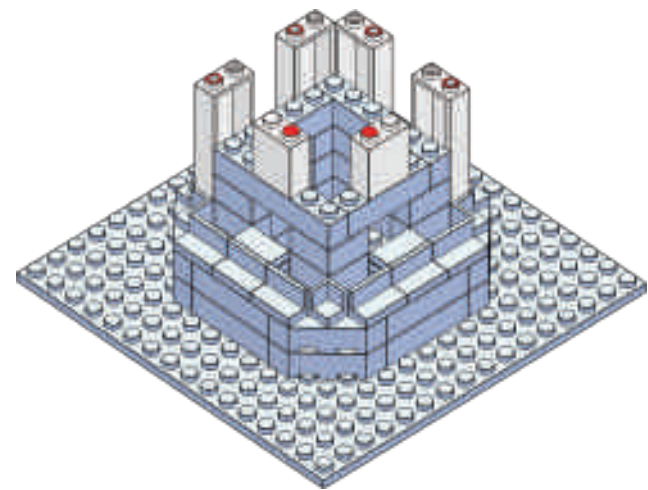
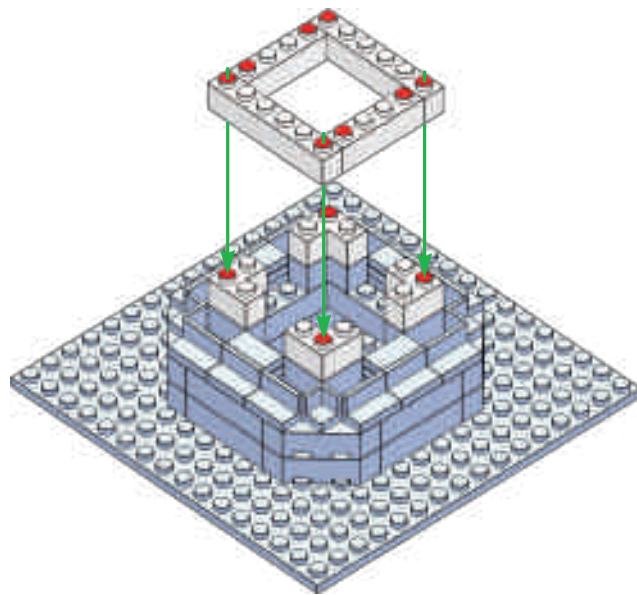

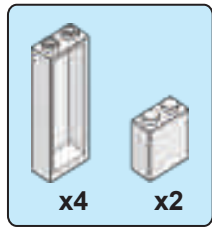

36

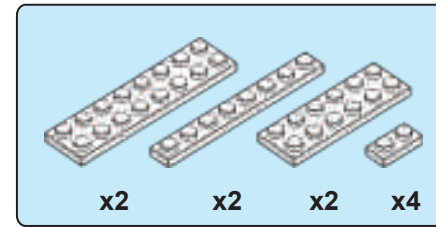
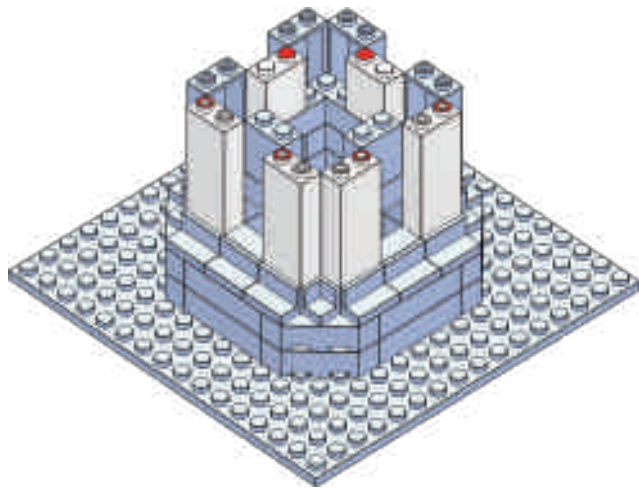

37

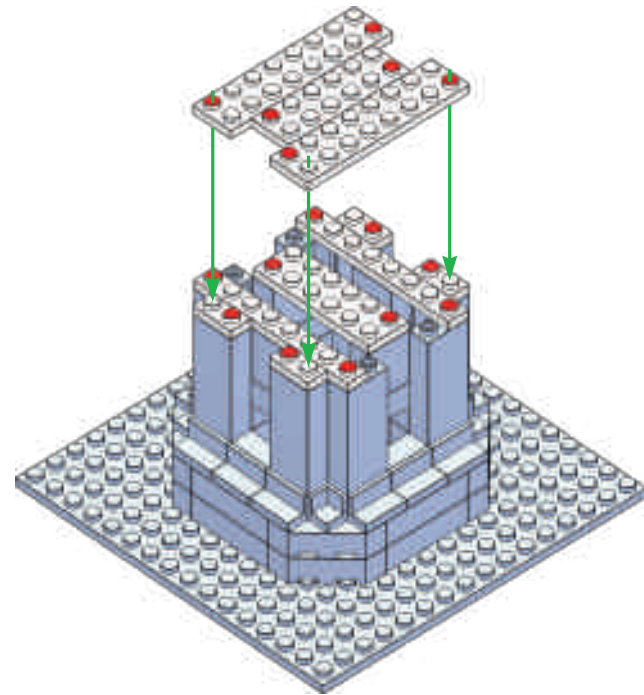

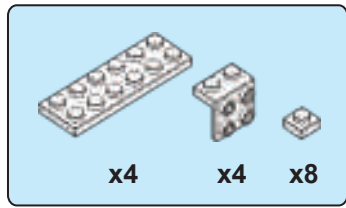

38

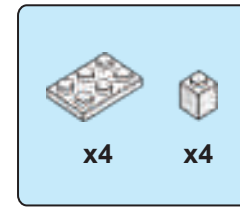

39

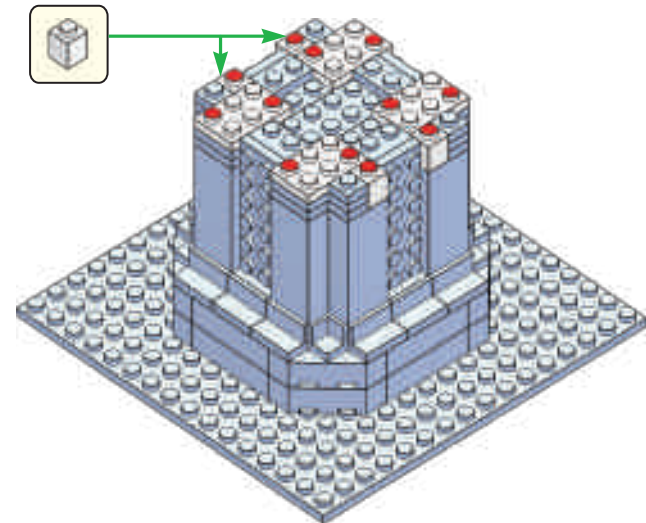
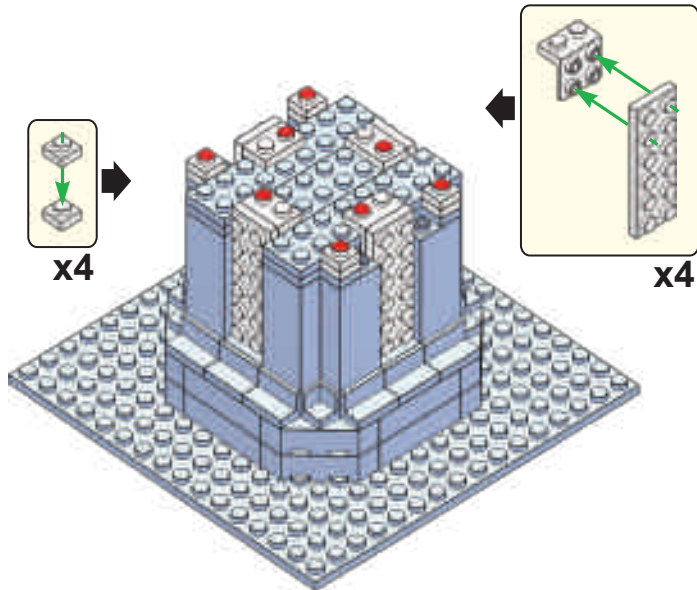

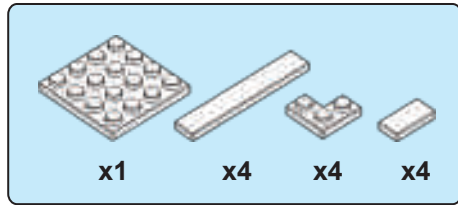

40

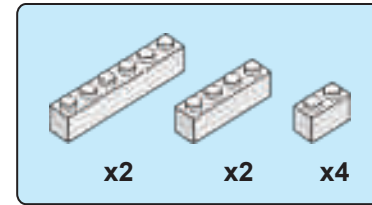
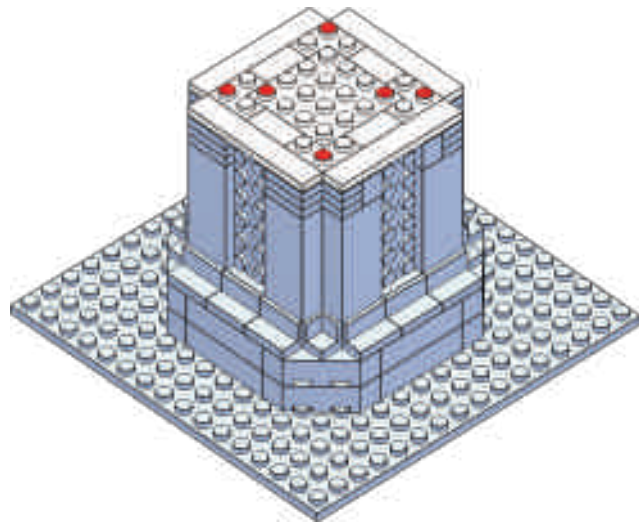

41

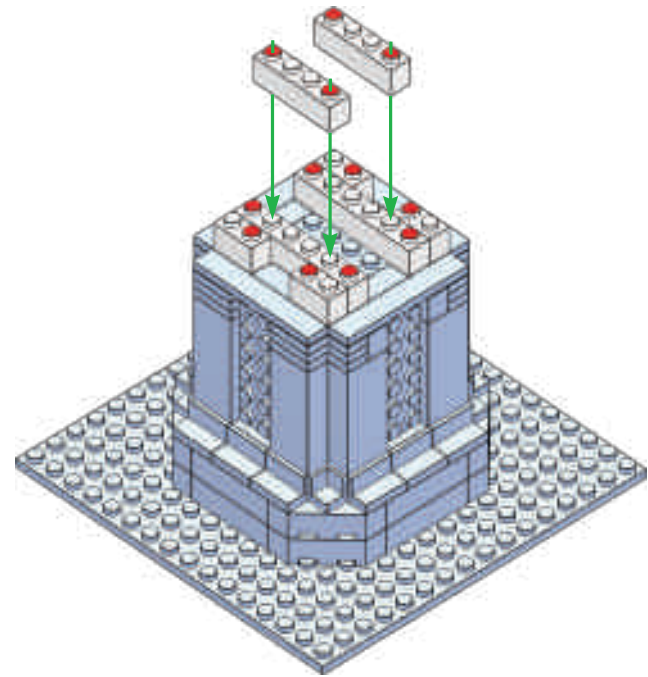

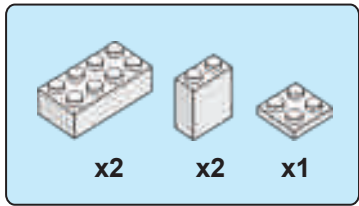

42

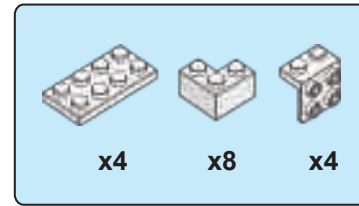

43

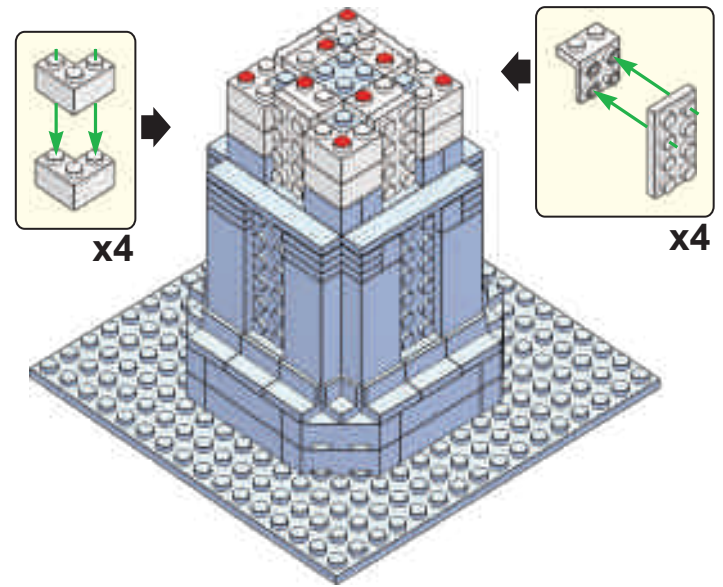
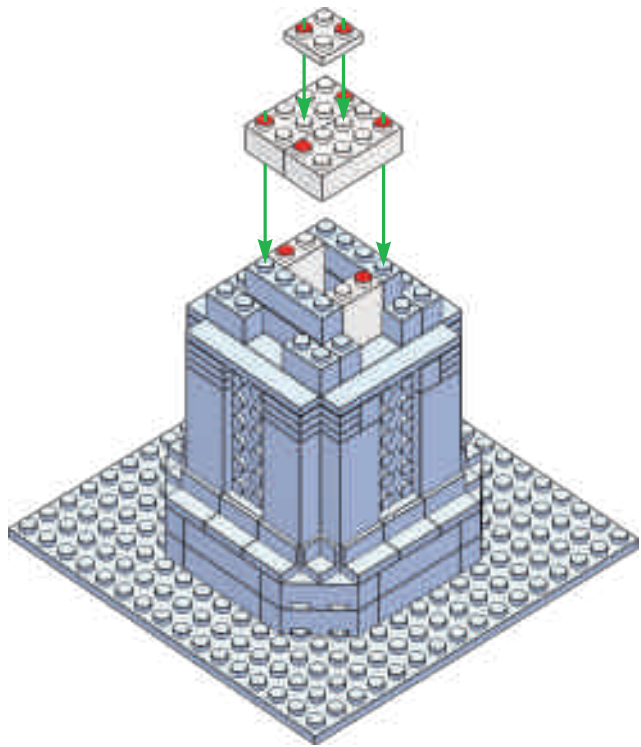

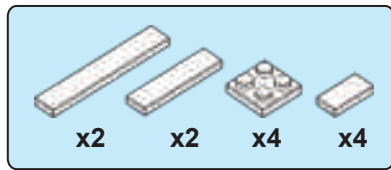

44

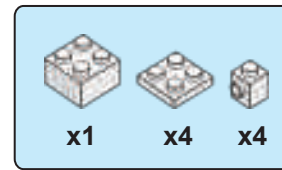
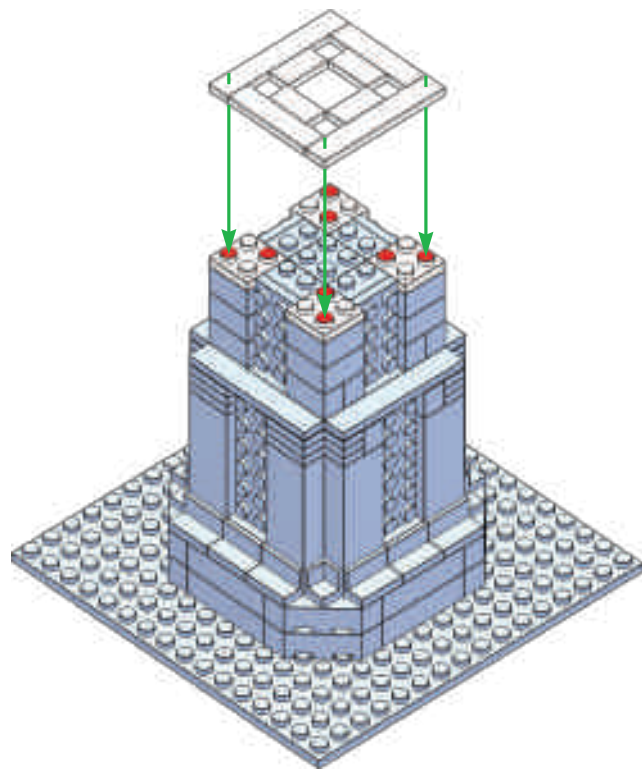

45

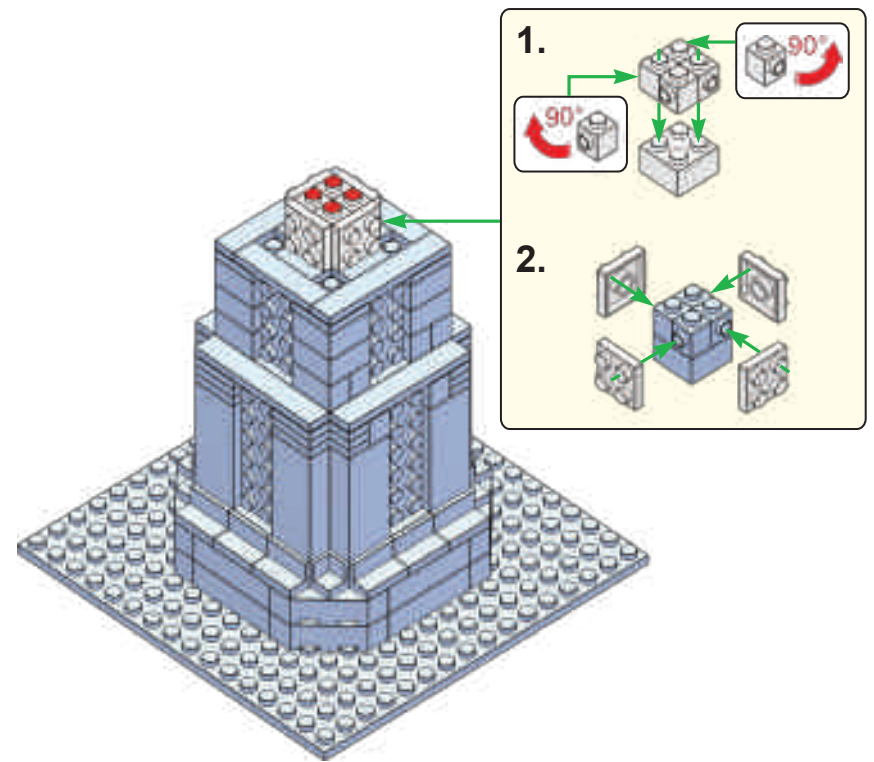

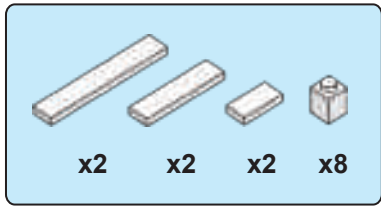

46

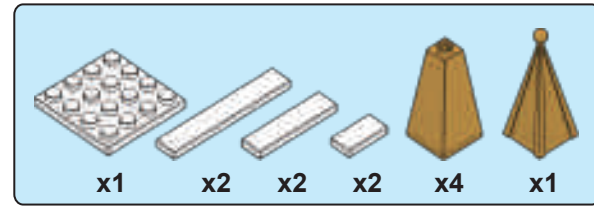

47

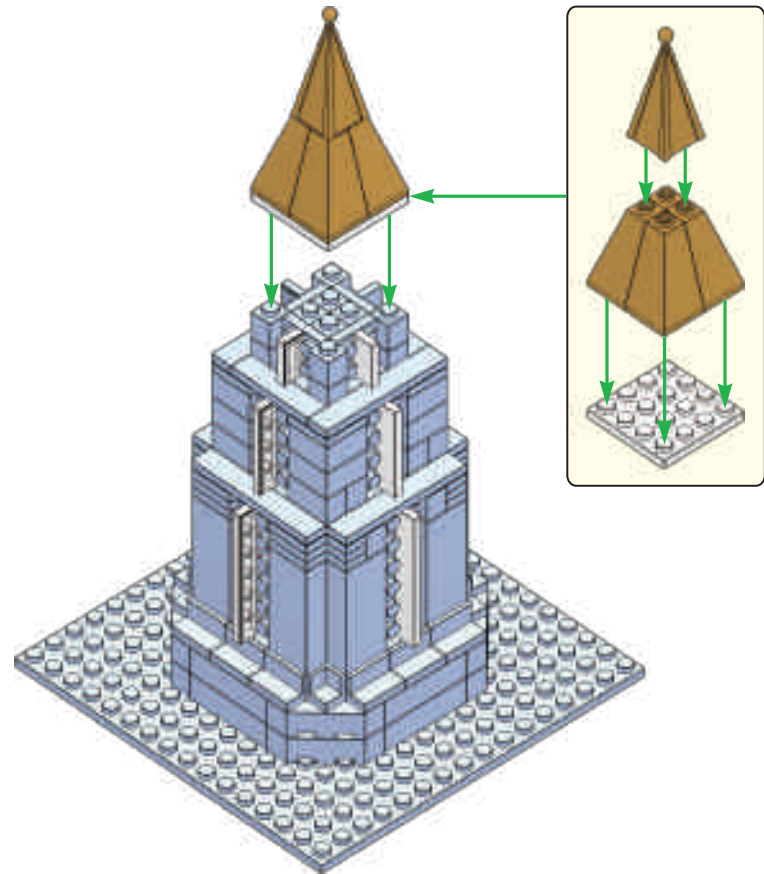
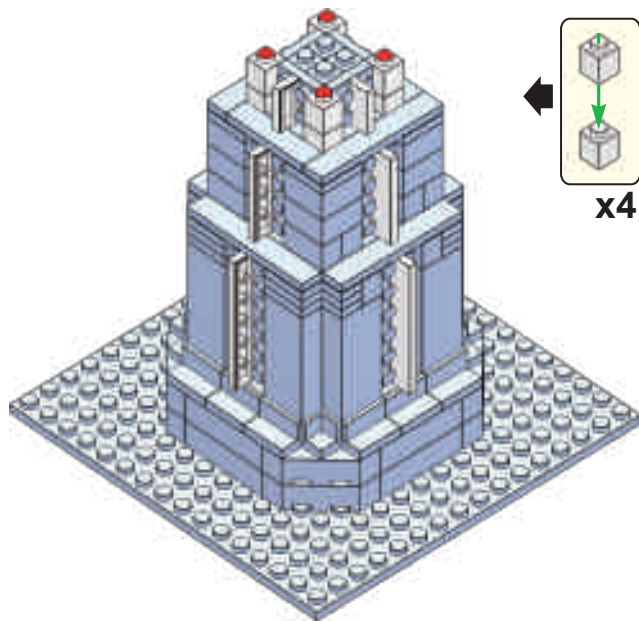

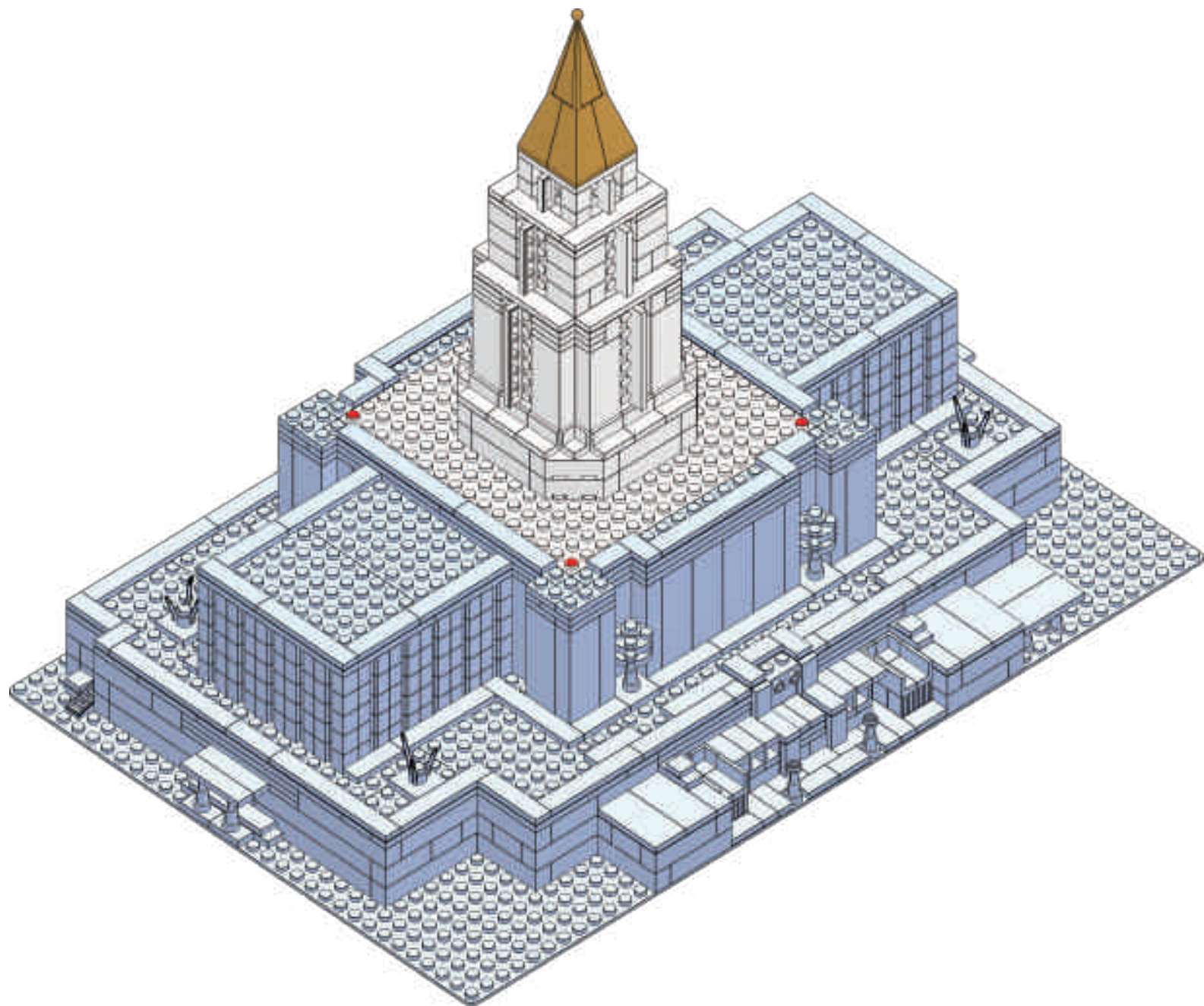

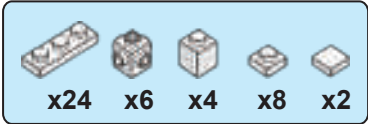

49

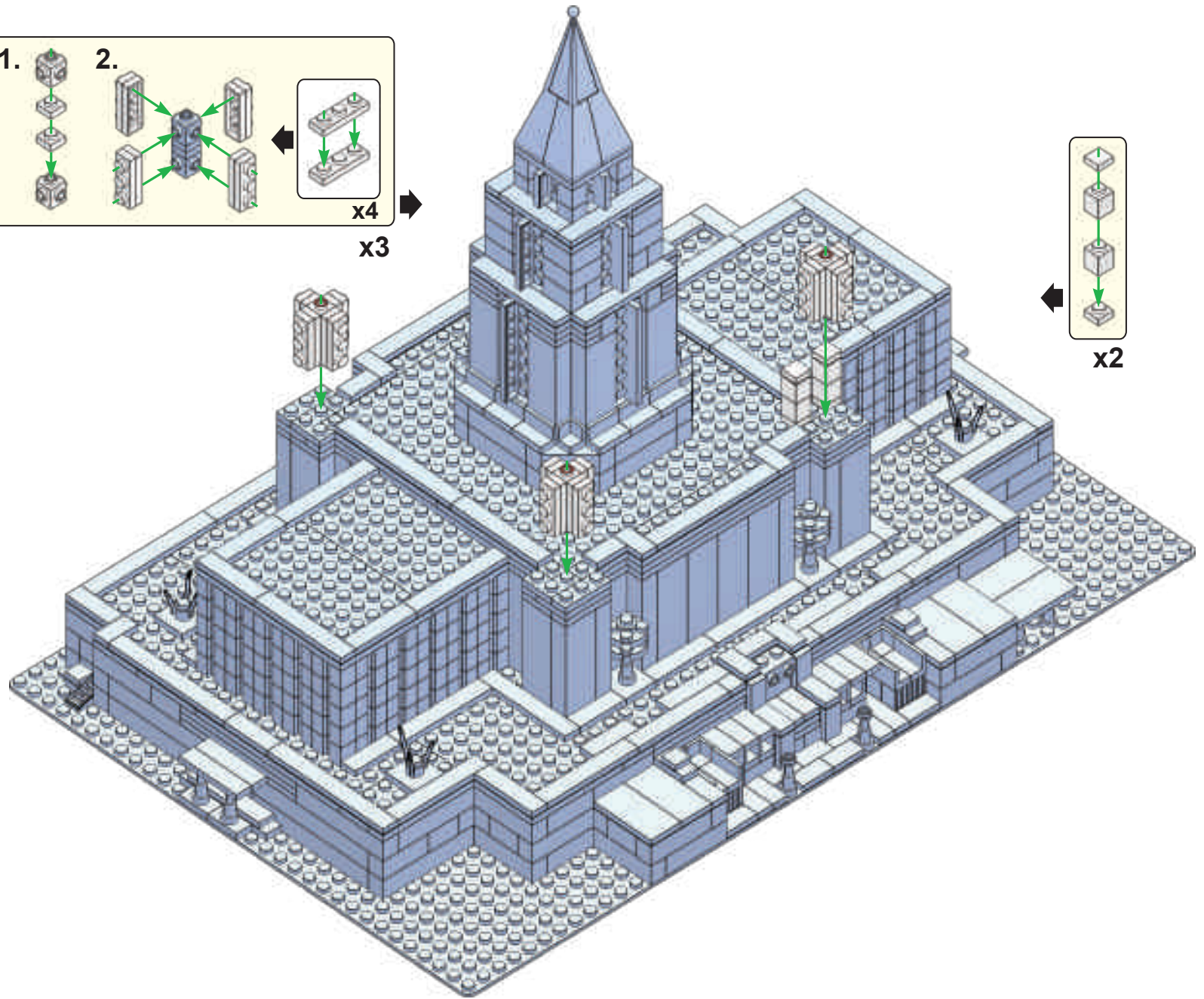
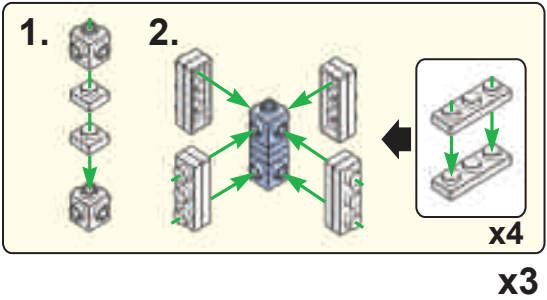

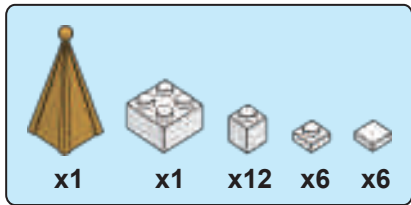

50

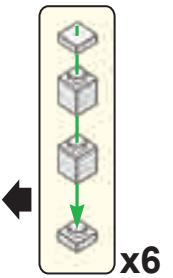
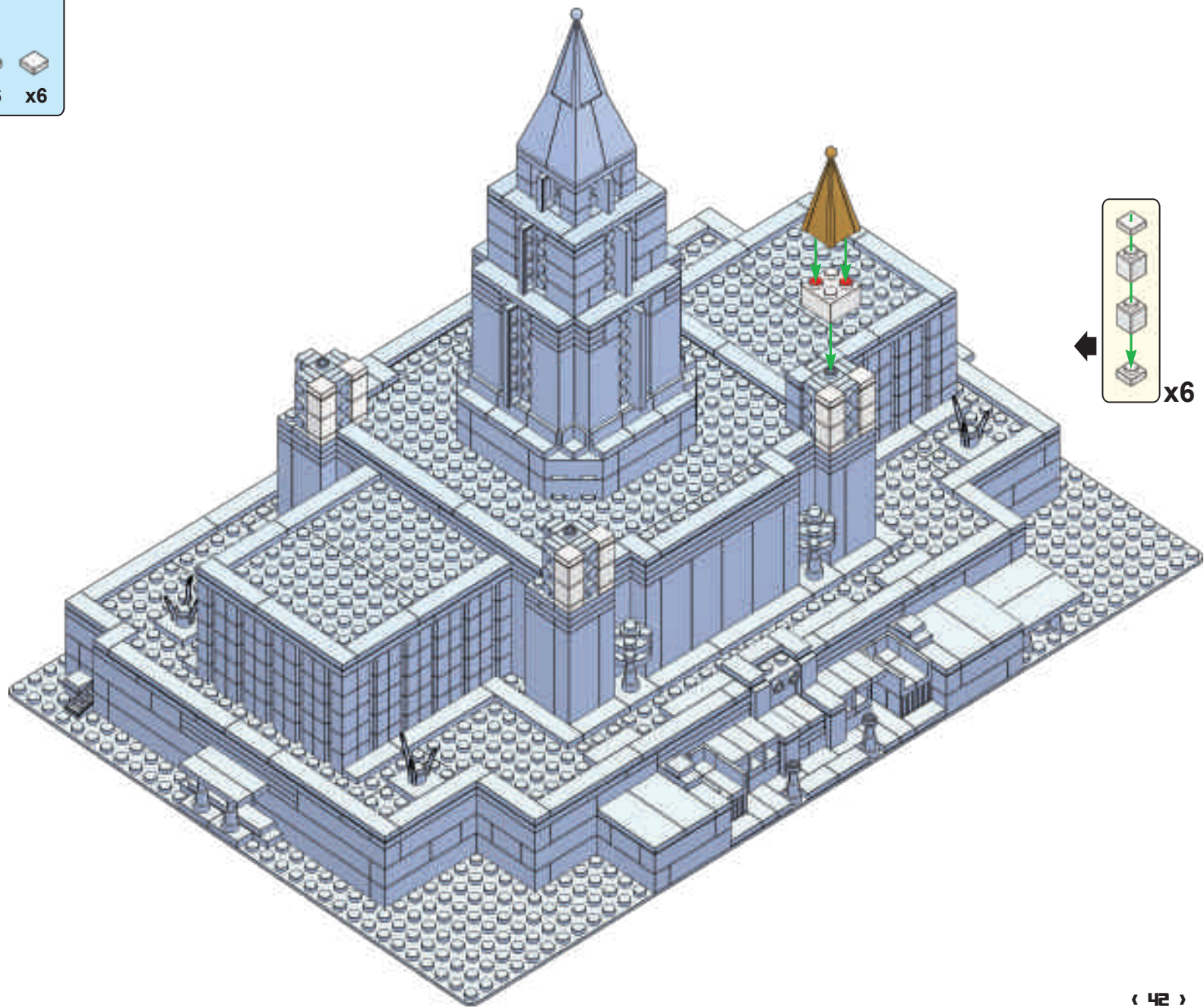



51

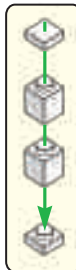

x2

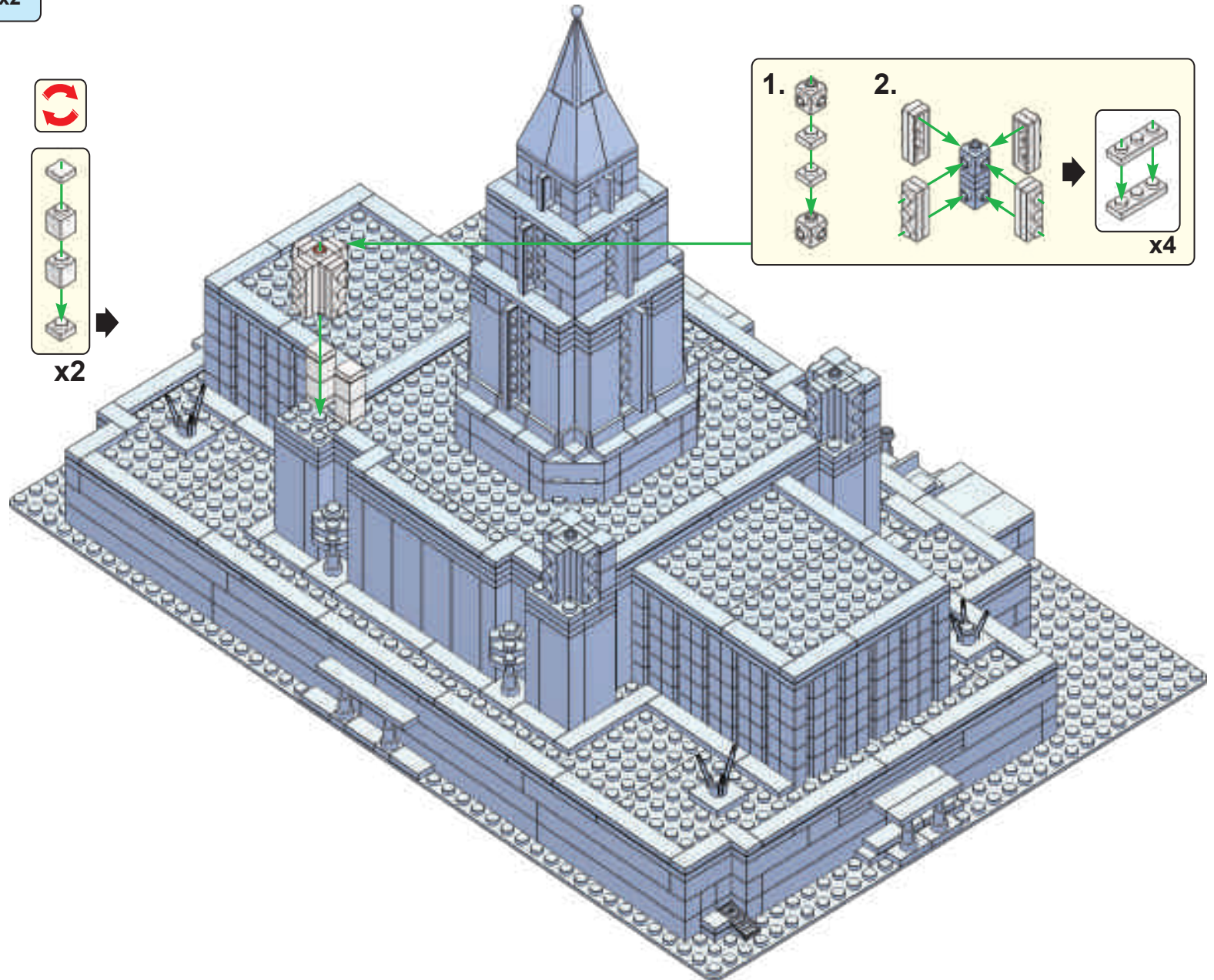

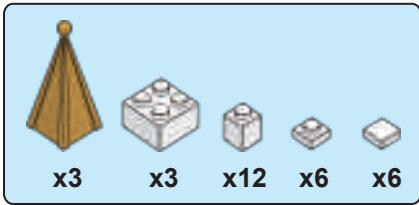

52

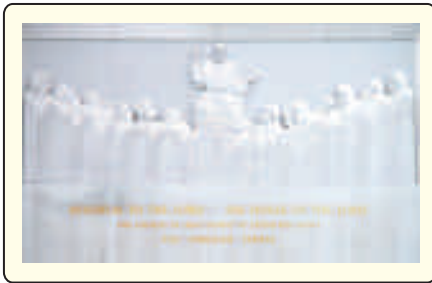
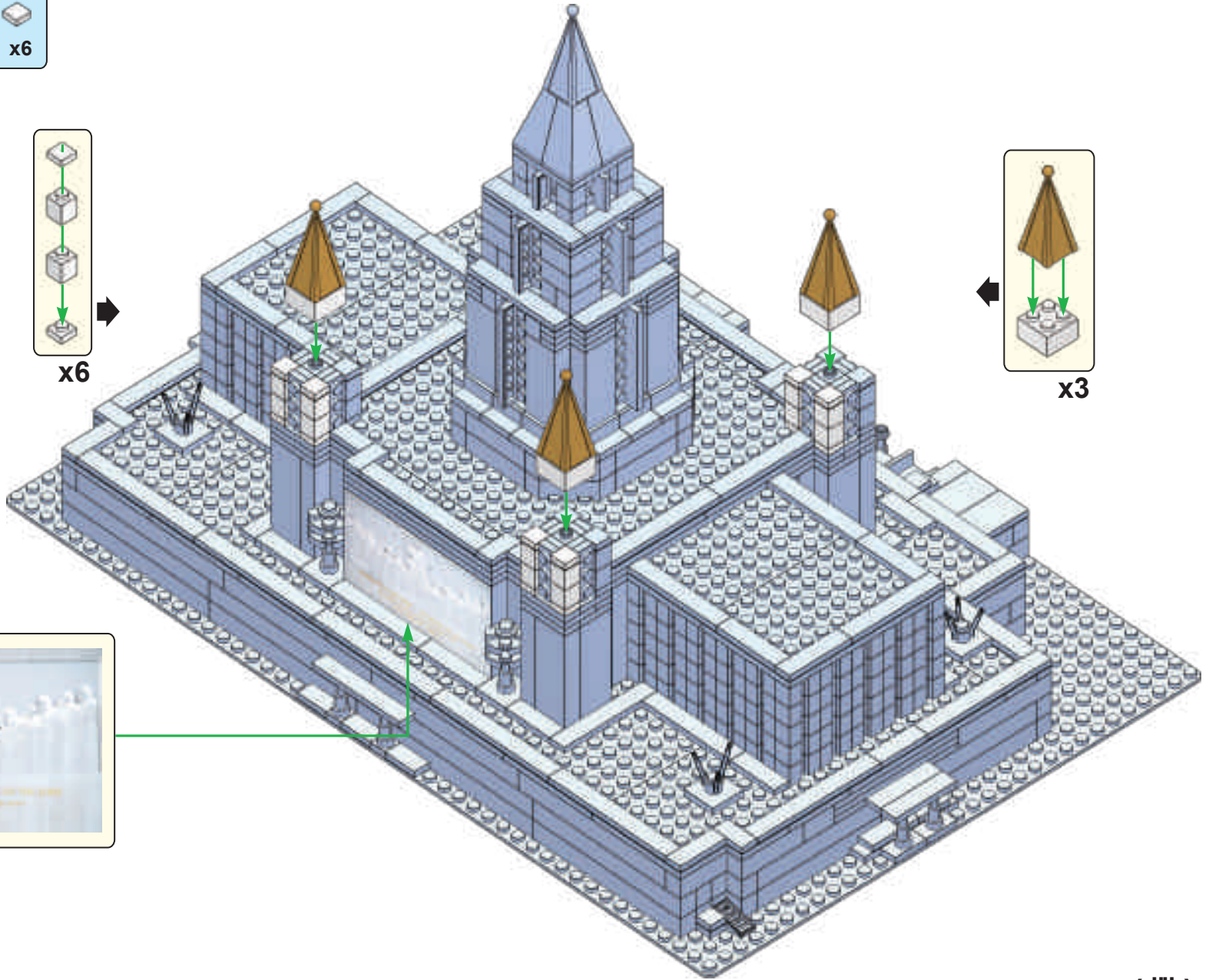
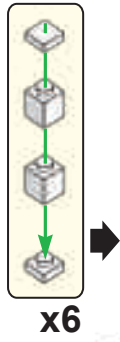



Send us a picture together with your completed temple set to info@brickemyoung.com and receive free Missionary figurines!



Warning! Choking hazard. Small parts.
Achtung! Erstickungsgefahr. Enthält Kleinteile.
Attention! Risque d'étouffement. Petites pièces.
Avvertenza! Pericolo di soffocamento. Contiene parti piccole.
Waarschuwing! Verstikkingsgevaar. Kleine deeltjes.
iAdvertencia! Riesgo de asfixia. Piezas pequeñas.
Advarsel! Kvælningsfare. Små dele.
Varoitus! Tukehtumisvaara. Pieniä osia.
Varning! Kvävningrisk. Innehåller smådelar.
Atenção! Perigo de asfixia. Peças pequenas.
Προειδοποίηση! Κίνδυνος πνιγμού. Μικρά κομμάτια.
警告! 窒息の危険性。小さな部品が入っていますので、ご
注意ください。
警告! 小心窒息。当心小物件。
경고! 질식 위험. 작은 부품 포함.
Внимание! Риск удушения. Содержит мелкие детали.

Ostrzeżenie! Zagrożenie zadławienia. Małe elementy.
Upozornění! Nebezpečí udušení. Obsahuje malé součástky.
Upozornenie! Nebezpečenstvo udusenja. Obsahuje malé súčasti.
Figyelmeztetés! Fulladásveszély! Kis elemeket tartalmaz.
Обережно! Ризик задухи. Містить дрібні деталі.
Upozorenje! Opasnost od gušenja. Sitni dijelovi.
Упозорење! Опасност од гушења. Мали делови.
Opozorilo! Nevarnost zadušitve. Majhni delčki.
Avertisement! Pericol de sufocare. Piese mici.
Внимание! Опасност от задавяне. Малки части.
Brīdinājums! Pastāv nosmakšanas risks. Satur sīkas daļas.
Hoiatuus! Lämbumisoht. Sisaldab väikseid osi.
Ispějimas! Uždusimo pavojus! Komplekte yra mažų detalių.
Dikkat! Boğulma tehlikesi. Küçük parçalar.

All copyrights, trademarks, intellectual property and other information contained belong to Brick'em Young.

No unauthorized usage or distribution of this material (including instruction booklet)

without the expressed written consent of Brick'em Young.

Brick'em Young is not owned or affiliated with The Church of Jesus Christ of Latter-day Saints.

Further questions can be directed to: service@brickemyoung.com.

This brick set contains many small bricks, Parental involvement is recommended!

www.brickemyoung.com

Product # 34:2

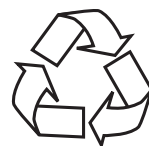

MADE IN CHINA