

lilitab Wall Pro

Packing List and Assembly Instructions

v.1.0



TABLE OF CONTENTS

LILITAB WALL PRO PACKAGING AND ASSEMBLY INSTRUCTIONS

lilitab Wall Pro Assembly Preparation	3
lilitab Wall Pro Features.....	4
lilitab Wall Pro Assembly Instructions	6
Using the iPad Power Button Trigger and MagKey	8

ASSEMBLY PREPARATION

TO ASSEMBLE YOUR LILITAB YOU WILL NEED:

- ✓ Apple iPad power adapter that came with your iPad

TO MOUNT YOUR LILITAB YOU WILL NEED:

- ✓ 4 x flat-head mount screws suitable for your wall surface

PACKING LIST

1 x head unit & faceplate
(with internal cable
to suit your tablet)

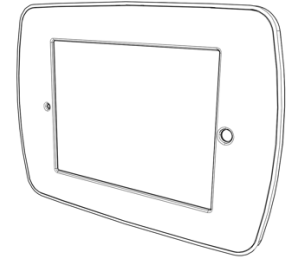

1 x wall mount

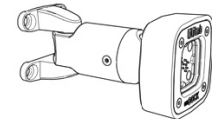

1 x bumper plate



1 x tilt control L key



1 x MagKey



2 x Keys for your MagDock

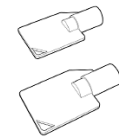

FEATURES

KEYLOCK

Turn the key to dock/undock your head unit. When the head unit is docked it automatically begins charging. Head unit can be docked in any orientation.

NOTE: Ensure the unit is locked when docked. Tilting or using the unit without the lock engaged will cause it to fall off.

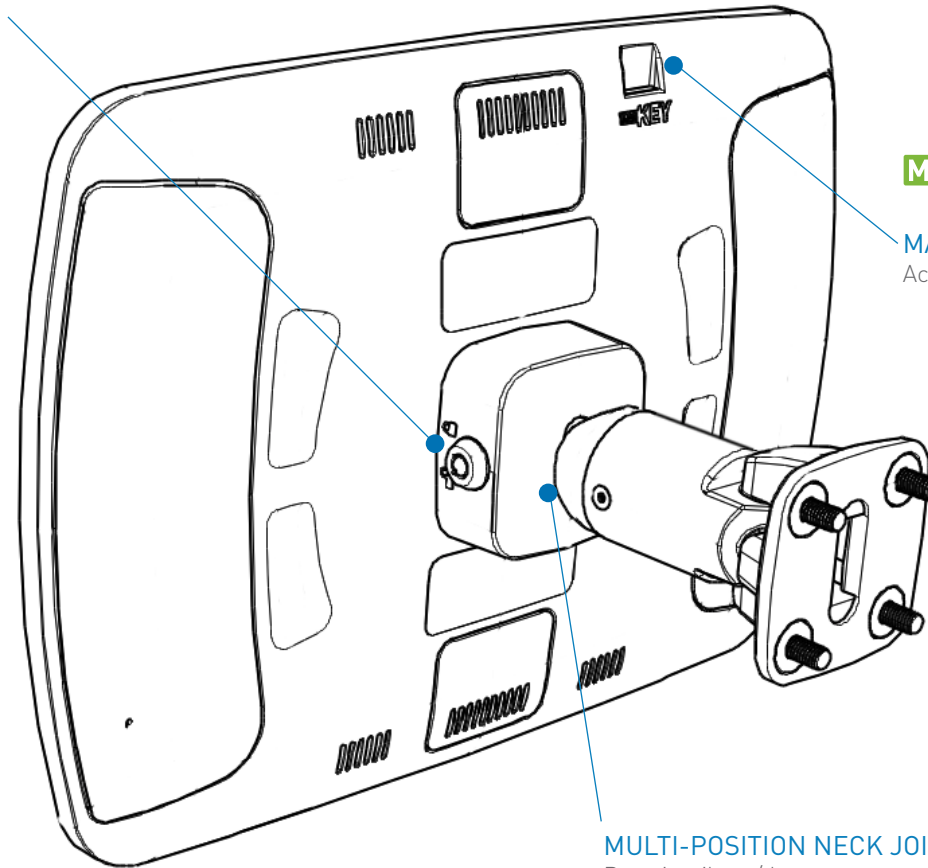

MAGKEY

MAGKEY SLOT

Accepts a MagKey for securely sleeping an iPad.

MULTI-POSITION NECK JOINT

Permits tilt up/down.

It has two operator configurable modes:

1. **Fixed.** The head unit can be set to any fixed +/-35° angle.
2. **Tilt.** Can be configured to allow the user to tilt the head unit.

EXPLODED VIEW

HEAD UNIT

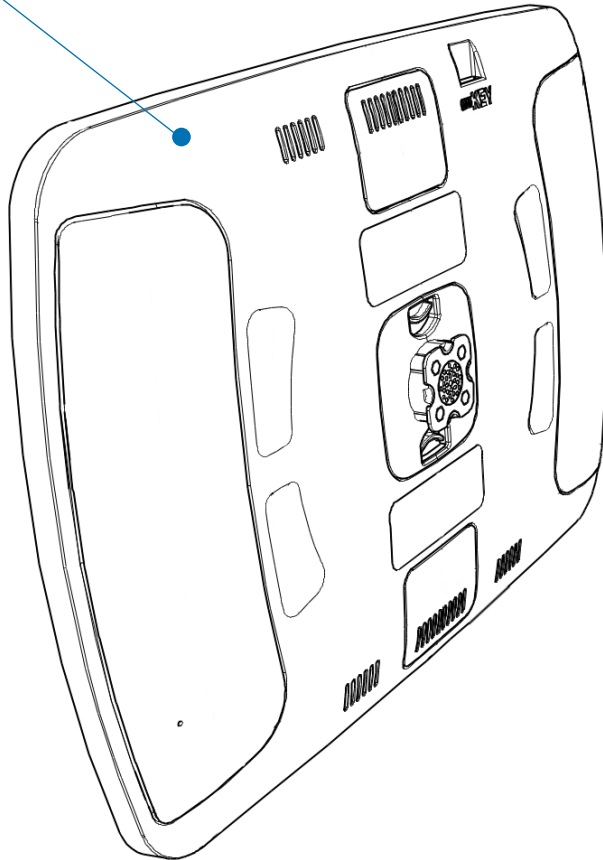

MAG DOCK

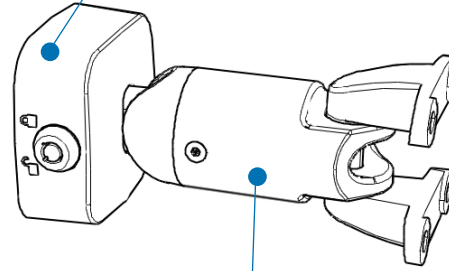

MOUNT ARM

BUMPER PLATE

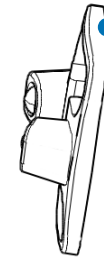

ASSEMBLY INSTRUCTIONS

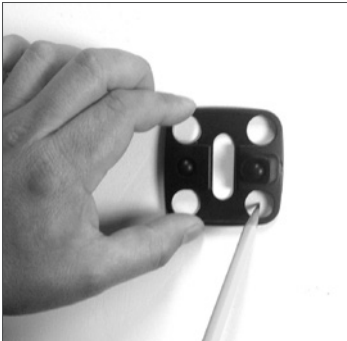

1. Use bumper plate to mark screw locations on wall.

NOTE: If you are routing the USB cable through your wall substrate trace the oval opening in the center of the bumper plate to mark the area that you will need to cutout to pass the USB cable through.



2. Attach lilitab Wall mount arm to wall using 4 x flathead screws appropriate for your wall substrate (not included).

NOTE: Ensure the bumper plate is positioned between the mount arm and wall in the desired orientation to prevent the unit from hitting the wall when positioned.



3. Open the head unit by placing it facedown on a clean surface and squeezing the finger latches together as shown. Carefully lift up and the faceplate will come off, allowing access to the inside of the head unit.

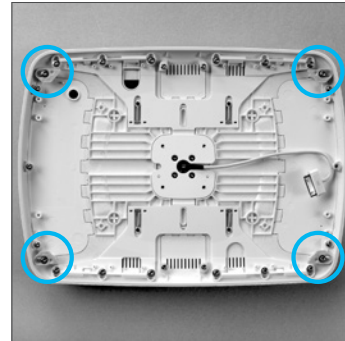

4. Place the head unit onto a clean surface with the inside of the enclosure facing up (the lilitab logo on the rear of the unit will face down and away from you). Slide all four of the green retaining clips towards the outside of the enclosure.

NOTE: The green keepers will not be present for the iPad Air, Google Nexus, Samsung Galaxy Tab 3 or Samsung Note. The faceplate's locating tabs will hold the tablet in place.

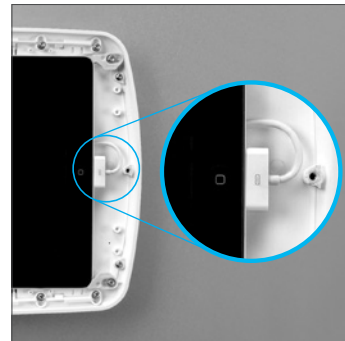

5. Plug the cable that came with your tablet into your tablet's charge port and place it inside the enclosure face up (screen faces towards you).

NOTE 1: Pro head units come with a charge cable for your tablet

NOTE 2: If your tablet is a Samsung Galaxy Tab or Note see step 6 for alternate cable installation instructions.



6. If you are installing your own charge cable for a Samsung device, use the cable routing clips as shown to ensure everything fits properly.

ASSEMBLY INSTRUCTIONS

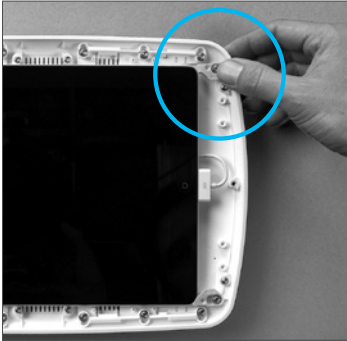

- 7. Slide all four green retaining clips** towards the center of the tablet ensuring they securely hold the tablet in place.

NOTE: You may need to adjust the position of the tablet slightly to allow all four clips to slide home properly.



- 8. Position the faceplate** over the tablet such that its openings are oriented as you wish (faceplates have different combinations of home button and camera openings). Gently press down around the edge of the faceplate and it will snap into place.

NOTE: If the faceplate does not snap into place evenly (or if one or more corners is lifting up) ensure that all four of the green retaining clips are seated fully home.



- 9. Place your lilitab onto the Magdock mount** in either landscape or portrait orientation.

TURN THE KEY to lock it in place.

WARNING: Not locking the Magdock WILL result in the unit falling off, possibly damaging the unit and / or the tablet. The lilitab Pro range is designed to be operated with the lock closed!

USING THE IPAD POWER BUTTON TRIGGER

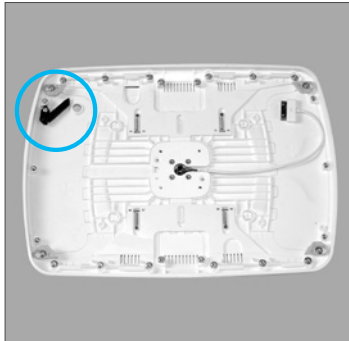

1. You can actuate the power button located on the edge of your iPad using the black Power Button Trigger shown to the left.



NOTE: Here's an iPad installed in the correct orientation with the Power Button Trigger next to the iPad's power button.

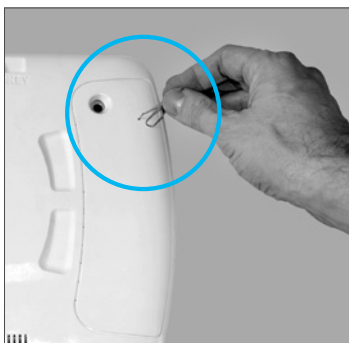

2. Once installed you can actuate the Power Button Trigger via a paper clip inserted into the small opening on the rear below the camera opening.

USING THE MAGKEY



1. You can use the included MagKey with an iPad 2,3 or 4 in your lilitab. The MagKey allows you to sleep the iPad without having any access to it. This ensures you (and your staff!) can turn your kiosk on and off at the end of the day without removing the iPad from the kiosk. You will always know when the iPad is sleeping because once inserted the MagKey pokes out the top of unit like a little flag.



2. To sleep your iPad simply insert your MagKey with the orange side facing front and the black side facing back.



3. Remove your MagKey and your lilitab will wake up, in exactly the same state it was in before it went to bed ;-)

NOTE: The MagKey is compatible with iPad 2, 3 and 4 or newer. It requires that the iPad Cover Lock/Unlock preference is turned on. You can find this in Settings→ General→ iPad Cover Lock/Unlock.

Replacement MagKeys can be ordered directly from the website: www.lilitab.com

Cleaning and caring for your lilitab.

To keep your lilitab looking and working great we recommend using a lint-free cloth to gently wipe it down.

To remove and prevent fingerprints we recommend Brillianize.

DO NOT use window cleaner, ammonia-based cleaners or any type of scouring or abrasive cleaner.



QUESTIONS?

We're here to help!

EMAIL: support@lilitab.com

PHONE: (888) 705 0190