

lilitab **Surface Pro**

Packing List and Assembly Instructions

v.2.0



TABLE OF CONTENTS

LILITAB SURFACE PRO PACKAGING AND ASSEMBLY INSTRUCTIONS

lilitab Surface Pro Assembly Preparation	3
lilitab Surface Pro Features.....	4
lilitab Surface Pro Mount Options.....	5
lilitab Surface Pro Mounting Pattern	6
lilitab Surface Pro Assembly Instructions	7
Using the iPad Power Button Trigger and MagKey	9
lilitab Cleaning Instructions.....	10

ASSEMBLY PREPARATION

TO ASSEMBLE YOUR LILITAB YOU WILL NEED:

- ✓ Phillips screwdriver

TO MOUNT YOUR LILITAB TO A SURFACE YOU WILL NEED:

- ✓ Powered drill/driver, preferably with impact action
- ✓ 4 x bolts or wood screws (m5, no.10, no.11, 3/16" or 13/64 diameter)

PACKING LIST

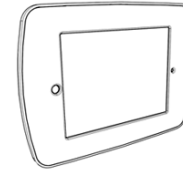

1 x head unit & faceplate

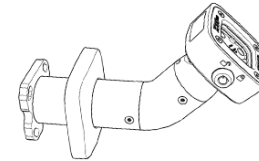

1 x mount arm with foot cover



1 x MagKey



2 x MagDock keys



1 x L key

Optional Base Plate Items

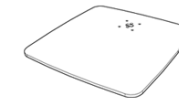

1 x base plate



4 x base screws

FEATURES

WIRELESS TRANSPARENCY

The lilitab head unit causes no radio interference.

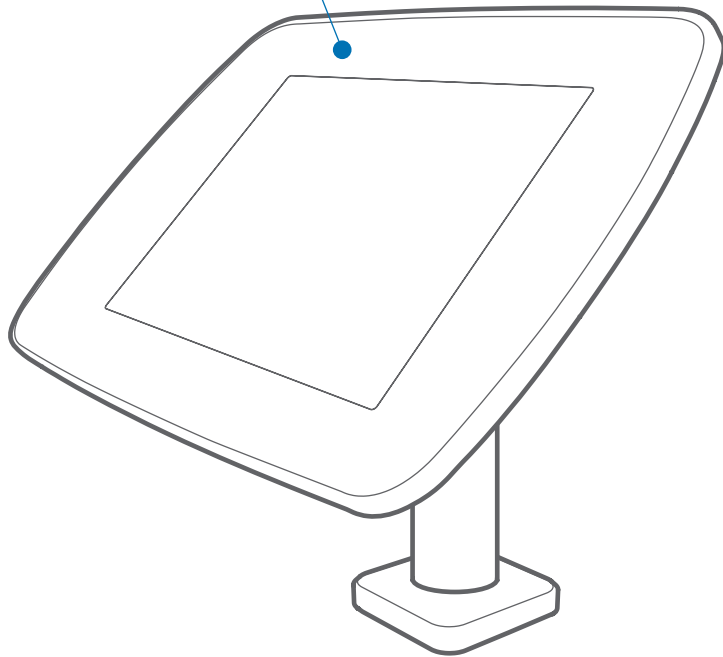

MAG DOCK

MAGDOCK

With the turn of a key, the operator can dock/undock the lilitab head unit. When the head unit is docked it automatically begins charging and it can be docked in any orientation.



Fixed. The head unit can be set to any fixed angle between completely vertical and +/-22.5°



Tilt. Can be configured to allow the user to tilt the head unit.

MULTI-POSITION NECK JOINT

Permits tilt up/down. It has two operator configurable modes:

MAG KEY

MAGKEY SLOT

Accepts a MagKey for securely sleeping an iPad.

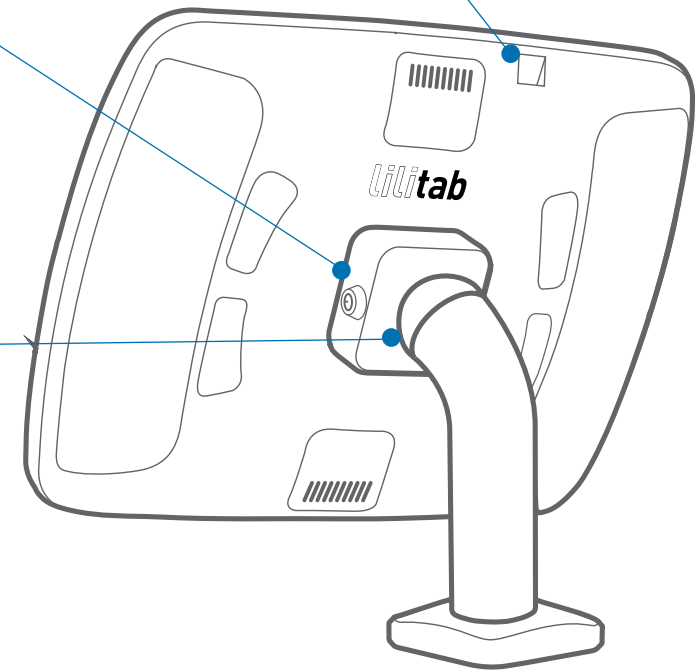

MOUNT OPTIONS

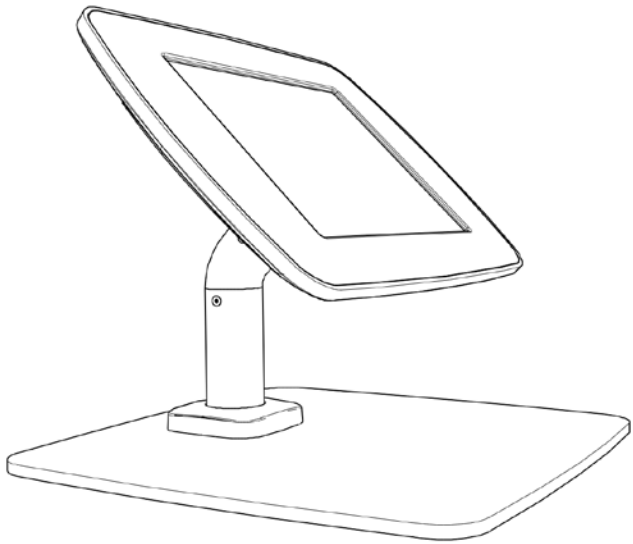

COUNTER TOP WITH OPTIONAL BASE PLATE

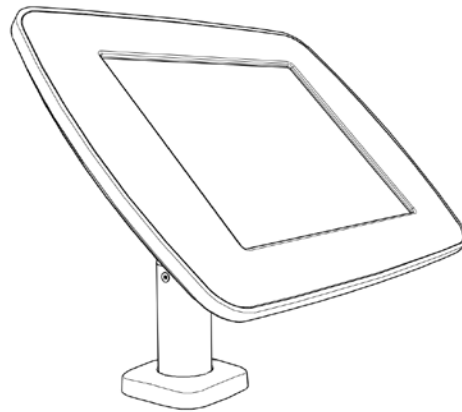

BOLT DIRECTLY TO HORIZONTAL SURFACE

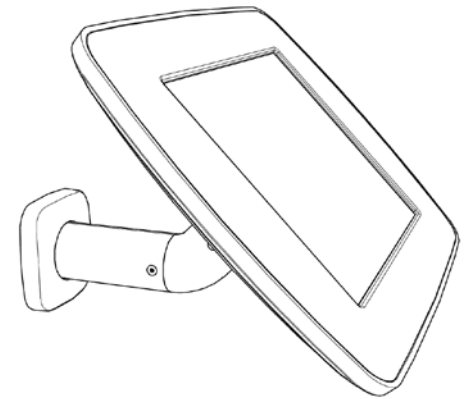

BOLT DIRECTLY TO VERTICAL SURFACE

MOUNTING PATTERN

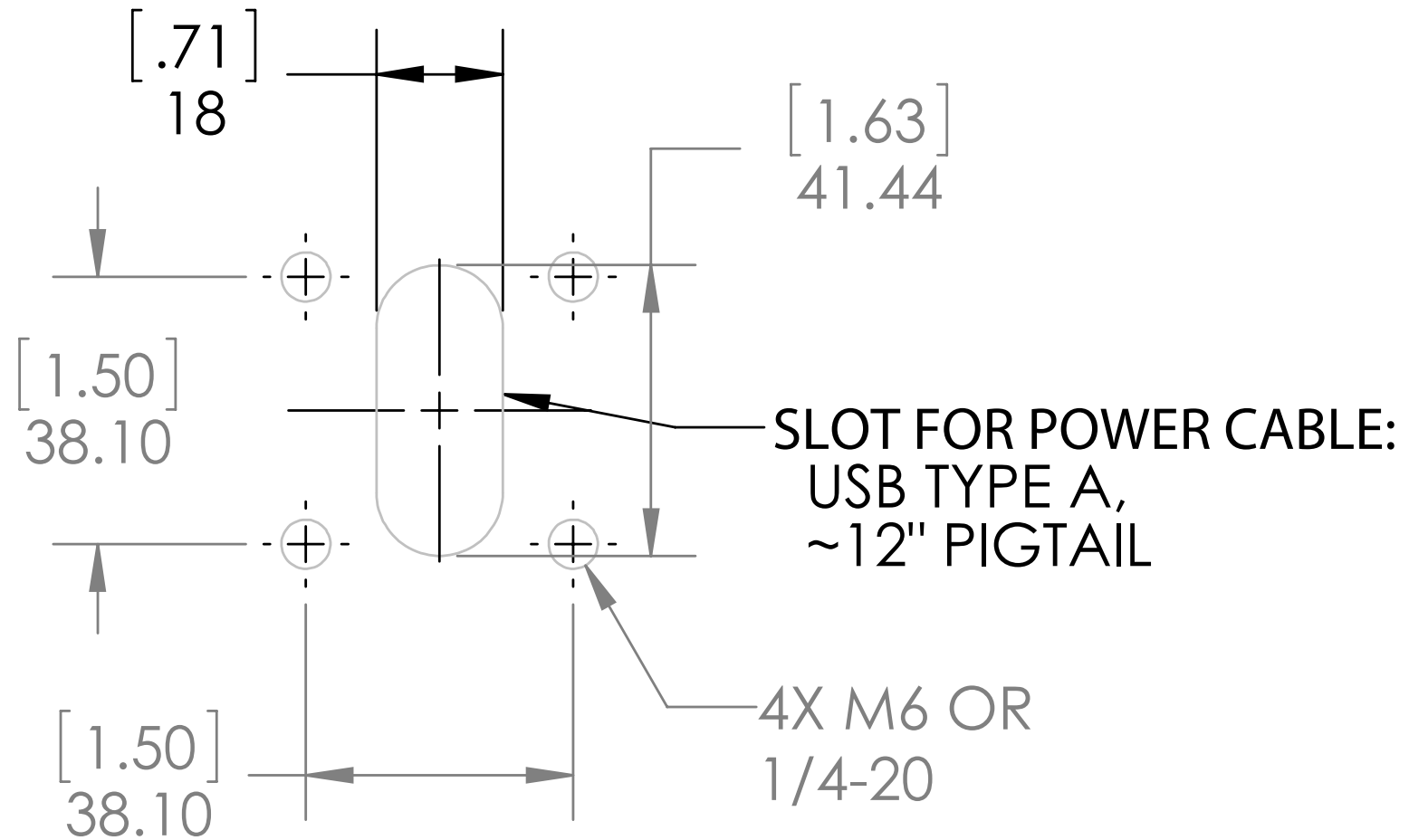

ASSEMBLY INSTRUCTIONS



- 1. Attaching directly to a counter or wall:** If you are not using a baseplate and instead attaching your unit directly to a surface you will need to obtain 4 fasteners suitable for your substrate. Use the mount pattern provided on page 6 of this document to mark your screw openings.



- 3. Open the lilitab head unit** by placing it facedown on a clean surface and squeezing the finger latches together as shown. Carefully lift up and the faceplate will release, allowing access to the inside of the head unit.



- Attaching the optional baseplate:** Use the **four base screws** to bolt your unit to the baseplate.

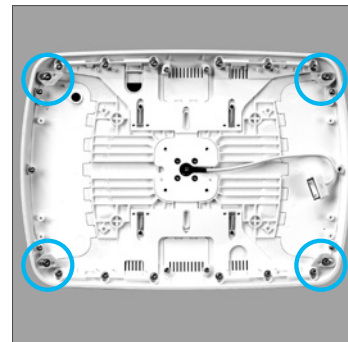

- 4. Place the head unit onto a clean surface** with the inside of the enclosure facing up (your charge and sync cable should be on the right side of the enclosure as shown in the photo). Slide all four of the green retaining clips towards the outside of the enclosure.

NOTE: The green keepers will **NOT** be present for the iPad Air, Google Nexus, Samsung Galaxy Tab 3 or Samsung Note. Instead the faceplate's locating tabs will hold the tablet in place.



- 2. Fit foot cover** over screws (velcro will hold it in place).



- 5. Plug the charge and sync cable** into your tablet's charge port, then place your tablet inside the enclosure face up.

If your tablet's charge connector is in the middle of the long edge ensure, your charge cable is inserted into the cable routing clips as shown in photo.

ASSEMBLY INSTRUCTIONS

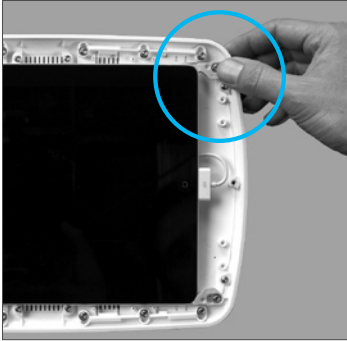

6. Slide all four green retaining clips

towards the center of the tablet.

NOTE: If clips aren't secure, adjust your tablet.

Lastly, position the faceplate over the tablet. Be sure to align the openings. Gently press down around the edges it will should snap into place.

NOTE: If the faceplate does not snap into place evenly ensure that all four green retaining clips are seated fully home.



7. Place your lilitab onto the MagDock mount in either landscape or portrait orientation.

TURN THE KEY to lock it in place.

WARNING: Not locking the MagDock WILL result in the unit falling off, possibly damaging the unit and/or the tablet. The lilitab Pro range is designed to be operated with the lock closed!



8. Configure head tilt. By default the head unit can be tilted by the user to suit. If you wish to disable tilt, position your head unit at the desired angle and tighten the bottom screw on the neck joint with the **silver L key** provided.

USING THE IPAD POWER BUTTON TRIGGER

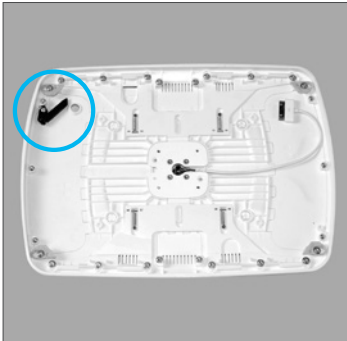

1. You can actuate the power button located on the edge of your iPad using the black Power Button Trigger shown to the left.



NOTE: Here's an iPad installed in the correct orientation with the Power Button Trigger next to the iPad's power button.

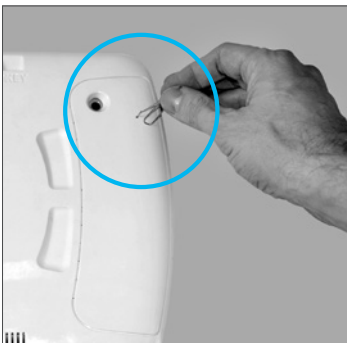

2. Once installed you can actuate the Power Button Trigger via a paper clip inserted into the small opening on the rear below the camera opening.

USING THE MAGKEY



1. You can use the included MagKey with an iPad 2,3 or 4 in your lilitab. The MagKey allows you to sleep the iPad without having any access to it. This ensures you (and your staff!) can turn your kiosk on and off at the end of the day without removing the iPad from the kiosk. You will always know when the iPad is sleeping because once inserted the MagKey pokes out the top of unit like a little flag.



2. To sleep your iPad simply insert your MagKey with the orange side facing front and the black side facing back.



3. Remove your MagKey and your lilitab will wake up, in exactly the same state it was in before it went to bed ;-)

NOTE: The MagKey is compatible with iPad 2, 3 and 4. It requires that the iPad Cover Lock/Unlock preference is turned on. You can find this in Settings→ General→ iPad Cover Lock/Unlock.

Replacement MagKeys can be ordered directly from the website: www.lilitab.com

LILITAB CLEANING INSTRUCTIONS



1. **Spray** the Brillianize onto one of the cloths provided.

WARNING: Other cloth/material may mar the surface of your lilitab



2. **DO NOT spray directly onto your lilitab!**



3. **Rub gently** in a circular motion to remove fingerprints and dirt.

WARNING: Applying excess pressure can mar the surface of your lilitab.



QUESTIONS?

We're here to help!

EMAIL: support@lilitab.com

PHONE: (888) 705 0190