

lilitab **Picture Mount Pro**

Packing List and Assembly Instructions

v.1.0



TABLE OF CONTENTS

LILITAB PICTURE MOUNT PACKAGING AND ASSEMBLY INSTRUCTIONS

lilitab Picture Mount Assembly Preparation	2
lilitab Picture Mount Assembly Instructions	3

ASSEMBLY PREPARATION

TO ASSEMBLE YOUR LILITAB PICTURE MOUNT YOU WILL NEED:

- ✓ Phillips screwdriver

TO MOUNT YOUR LILITAB PICTURE MOUNT TO THE WALL YOU WILL NEED:

- ✓ Either a Phillips screwdriver or powered drill/driver, preferably with impact action
- ✓ 4 x fasteners suitable for your wall

PACKING LIST

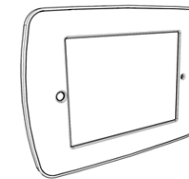

1 x head unit & faceplate



2 x MagDock keys



1 x picture mount base

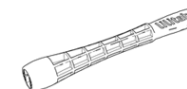

1 x keyholder

ASSEMBLY INSTRUCTIONS



1. Open the lilitab head unit by placing it facedown on a clean surface and squeezing the finger latches together as shown. Carefully lift up and the faceplate will release, allowing access to the inside of the head unit.



4. Slide all four green retaining clips towards the center of the tablet.
NOTE: If clips aren't secure, adjust your tablet. Lastly, position the faceplate over the tablet. Be sure to align the openings. Gently press down around the edges it will should snap into place.
NOTE: If the faceplate does not snap into place evenly ensure that all four green retaining clips are seated fully home.

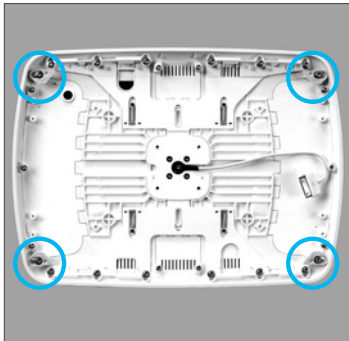

2. Place the head unit onto a clean surface with the inside of the enclosure facing up (your charge and sync cable should be on the right side of the enclosure as shown in the photo). Slide all four of the green retaining clips towards the outside of the enclosure.

NOTE: The green keepers will **NOT** be present for the iPad Air, Google Nexus, Samsung Galaxy Tab 3 or Samsung Note. Instead the faceplate's locating tabs will hold the tablet in place.

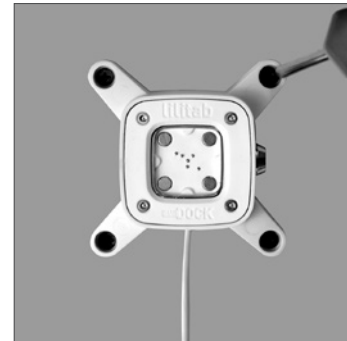

5. Attach picture mount to wall.
NOTE 1: You will need to purchase fasteners suitable for your wall.
NOTE 2: the charge cable can be routed down the face of the wall or internally inside the wall.



3. Plug the charge and sync cable into your tablet's charge port, then place your tablet inside the enclosure face up.

If your tablet's charge connector is in the middle of the long edge ensure, your charge cable is inserted into the cable routing clips as shown in photo.



6. Insert MagDock key into the **keyholder** provided.

ASSEMBLY INSTRUCTIONS

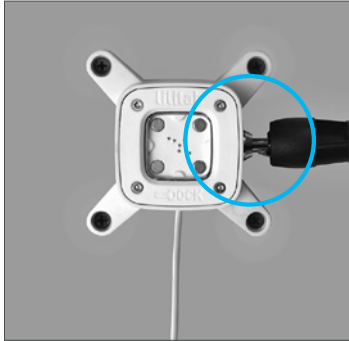

- 7. The keyholder** makes it easy to actuate the lock when the head is fitted.

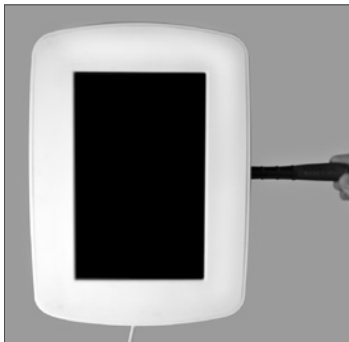

- 8. Dock your lilitab head unit** to the MagDock in portrait or landscape orientation.

WARNING: Not locking the MagDock WILL result in the unit falling off, possibly damaging the unit and/or the tablet. The lilitab Pro range is designed to be operated with the lock closed!

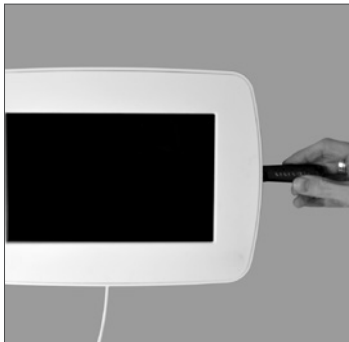

USING THE IPAD POWER BUTTON TRIGGER

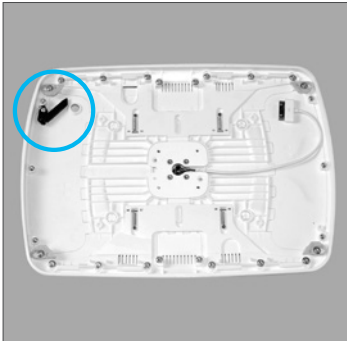

1. You can actuate the power button located on the edge of your iPad using the black Power Button Trigger shown to the left.



NOTE: Here's an iPad installed in the correct orientation with the Power Button Trigger next to the iPad's power button.

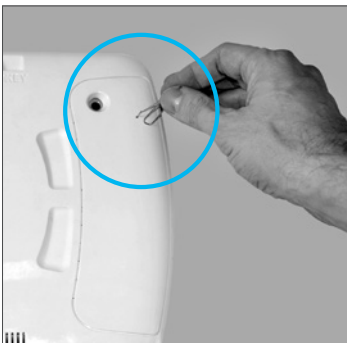

2. Once installed you can actuate the Power Button Trigger via a paper clip inserted into the small opening on the rear below the camera opening.

USING THE MAGKEY



1. You can use the included MagKey with an iPad 2,3 or 4 in your lilitab. The MagKey allows you to sleep the iPad without having any access to it. This ensures you (and your staff!) can turn your kiosk on and off at the end of the day without removing the iPad from the kiosk. You will always know when the iPad is sleeping because once inserted the MagKey pokes out the top of unit like a little flag.



2. To sleep your iPad simply insert your MagKey with the orange side facing front and the black side facing back.



3. Remove your MagKey and your lilitab will wake up, in exactly the same state it was in before it went to bed ;-)

NOTE: The MagKey is compatible with iPad 2, 3 and 4. It requires that the iPad Cover Lock/Unlock preference is turned on. You can find this in Settings→ General→ iPad Cover Lock/Unlock.

Replacement MagKeys can be ordered directly from the website: www.lilitab.com

Cleaning and caring for your lilitab.

To keep your lilitab looking and working great we recommend using a lint-free cloth to gently wipe it down.

To remove and prevent fingerprints we recommend Brillianize.

DO NOT use window cleaner, ammonia-based cleaners or any type of scouring or abrasive cleaner.



QUESTIONS?

We're here to help!

EMAIL: support@lilitab.com

PHONE: (888) 705 0190