

lilitab Counter Basic

Packing List and Assembly Instructions

v.2.0

TABLE OF CONTENTS

LILITAB COUNTER BASIC PACKAGING AND ASSEMBLY INSTRUCTIONS

lilitab Counter Basic Assembly Preparation	3
lilitab Counter Basic Features.....	4
lilitab Counter Basic Mount Options.....	5
lilitab Counter Basic Mounting Pattern	6
lilitab Counter Basic Assembly Instructions	7
Using the iPad Power Button Trigger and MagKey	10
lilitab Cleaning Instructions.....	11

ASSEMBLY PREPARATION

TO ASSEMBLE YOUR LILITAB YOU WILL NEED:

- ✓ Phillips screwdriver

TO MOUNT YOUR LILITAB TO A SURFACE YOU WILL NEED:

- ✓ Powered drill/driver, preferably with impact action
- ✓ 4 x bolts or wood screws (m5, no.10, no.11, 3/16" or 13/64 diameter)

PACKING LIST

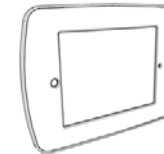

1 x head unit & faceplate

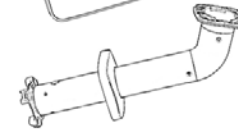

1 x mount arm with foot cover



3 x screw opening caps



1 x MagKey



4 x head mount security screws



1 x L key (silver)



1 x L key (black)

Optional Base Plate Items



1 x base plate



4 x base screws

FEATURES

WIRELESS TRANSPARENCY

The lilitab head unit causes no radio interference.

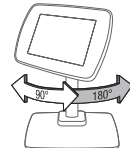
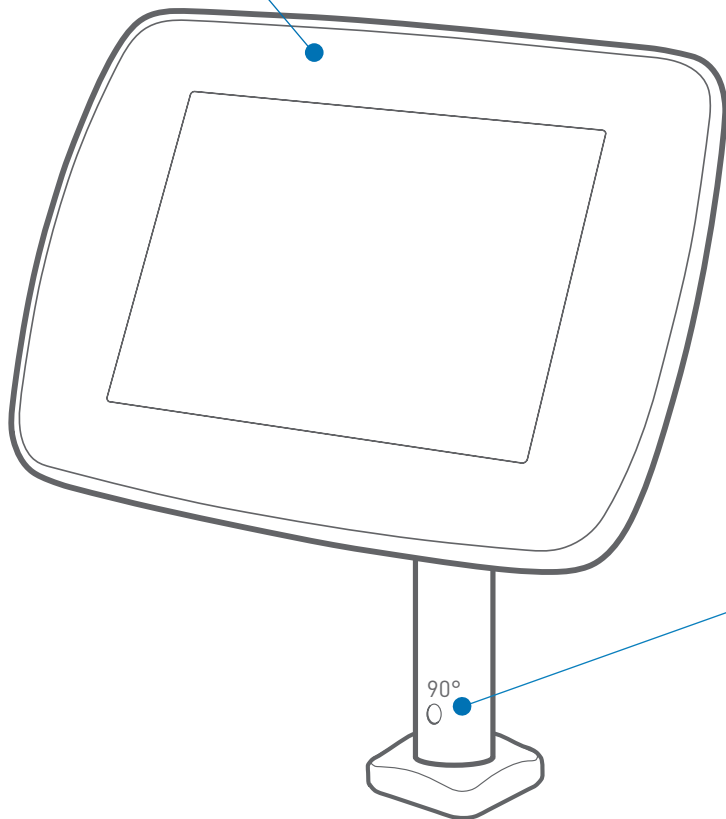

ROTATE FEATURE

The lilitab Counter can be configured to allow 90°, 180° or no rotation. By default it is set to 180°.

To disable rotation (and/ or adjust rotation tension) tighten the screw in the upper rear opening of the vertical tube to the desired level.

To switch from 180° to 90° remove the lower screw visible through the lower rear facing opening in the tube using the short black L Key provided and insert it into the threaded opening visible through the lower front opening.

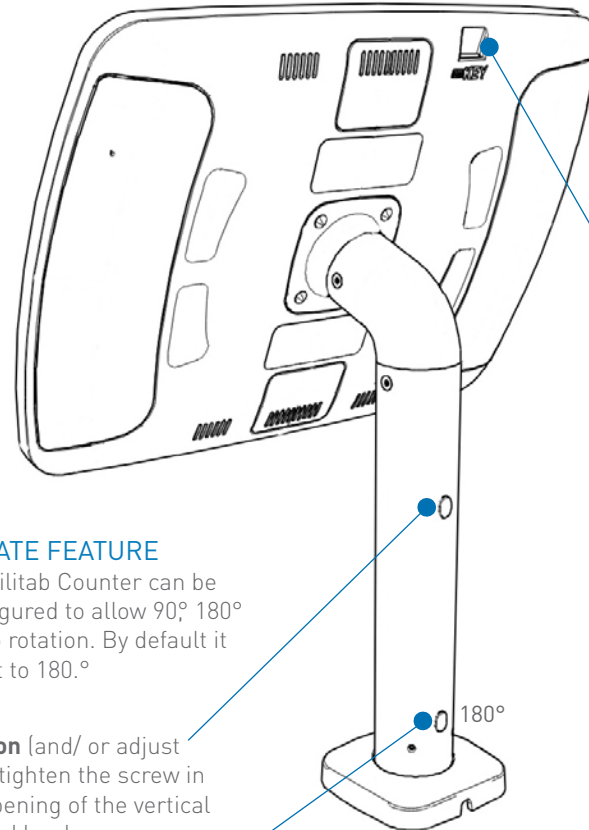

MAGKEY

MAGKEY SLOT

Accepts a MagKey for securely sleeping an iPad.

MOUNT OPTIONS

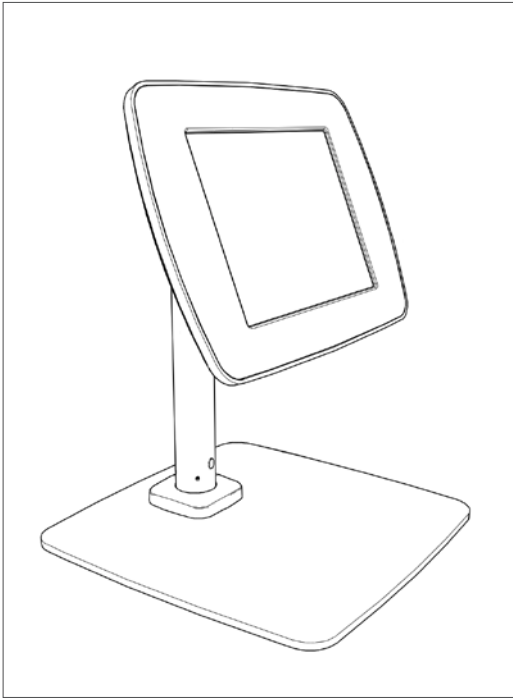

COUNTER TOP WITH OPTIONAL BASE PLATE

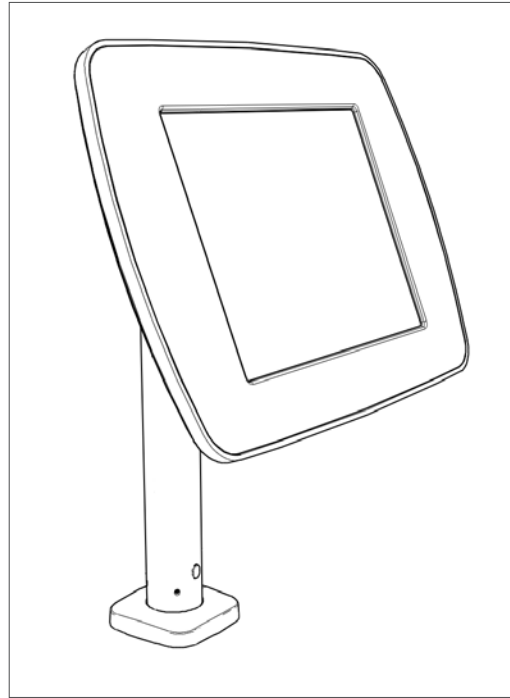

BOLT DIRECTLY TO COUNTER

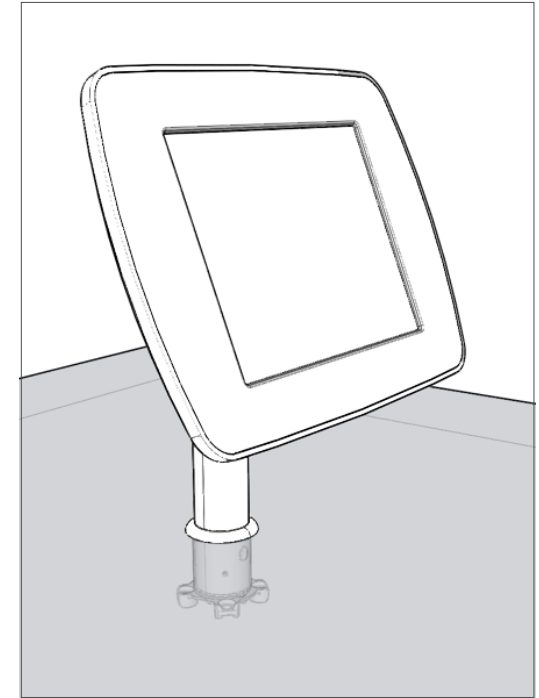

THROUGH-HOLE

[Drill 1-5/8" opening in counter, pass tube through counter and screw up from below. The trim ring finishes the rough opening]

MOUNTING PATTERN

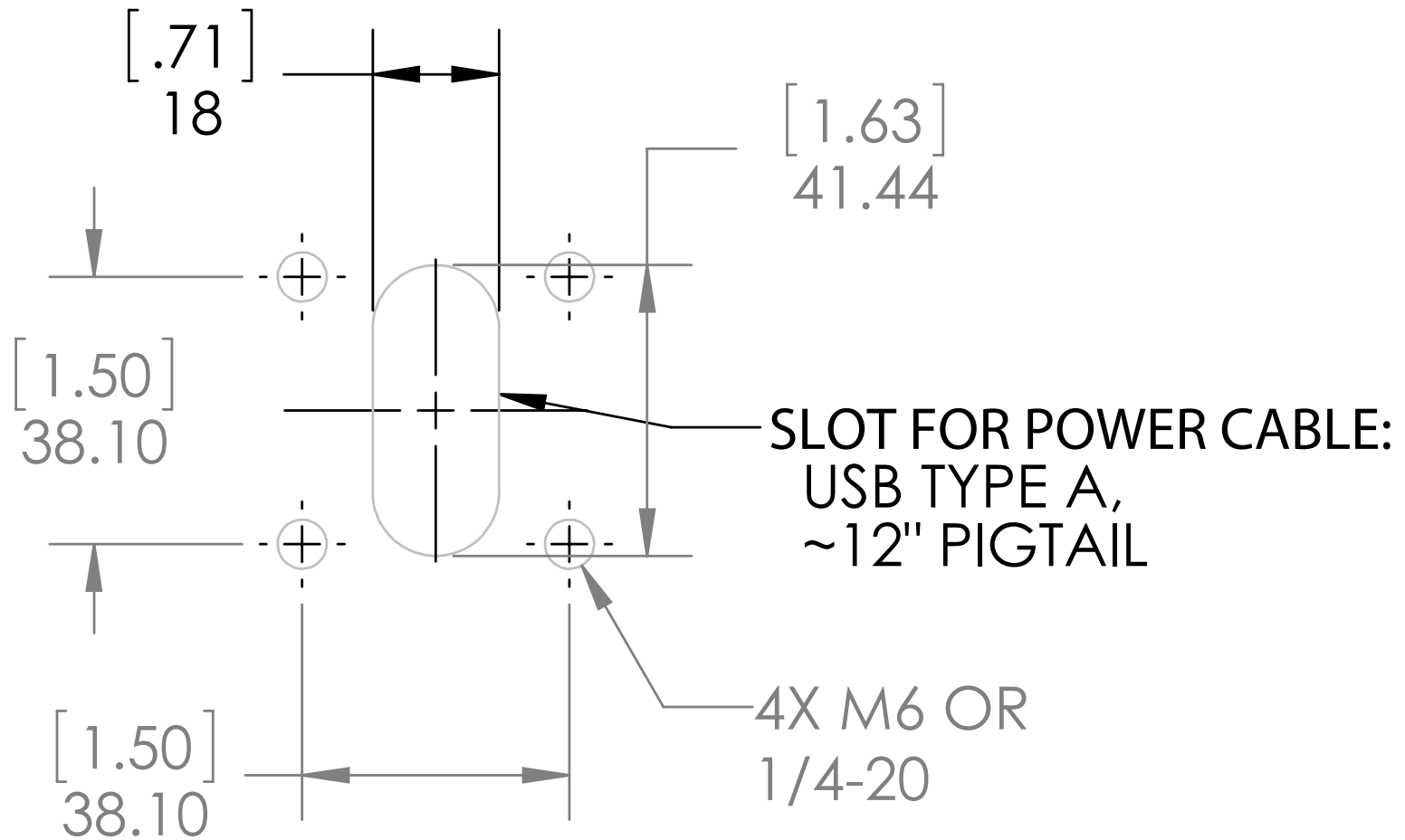

ASSEMBLY INSTRUCTIONS

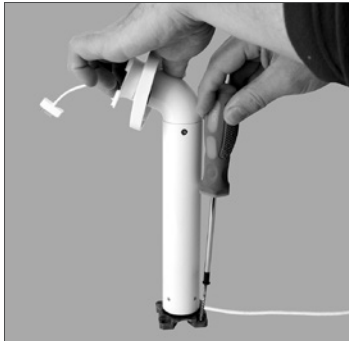

1. Attaching directly to a counter: If you are not using a baseplate and wish to attach your unit directly to a counter top (or other horizontal surface), you will need to obtain 4 fasteners suitable for your substrate. Use the mount pattern provided on page 6 of this document to mark your screw openings.

Be careful to:

- Route your usb cable (see NOTE 1) and
- Position your center of rotation (see NOTE 2) appropriately.

Attaching to the optional baseplate:

Use the **four base screws** to bolt your unit to the baseplate.

Be careful to:

- Route your usb cable (see NOTE 2) and
- Position your center of rotation (see NOTE 3) appropriately.

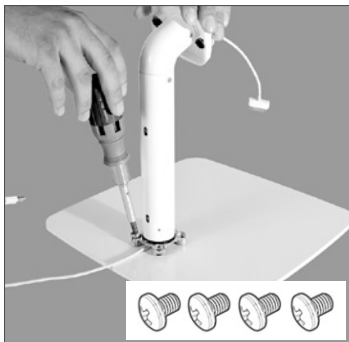

NOTE 1: Cable Routing

USB cable can exit out back of unit, through the bottom or through counter or under baseplate.



Option 1: Surface Mount

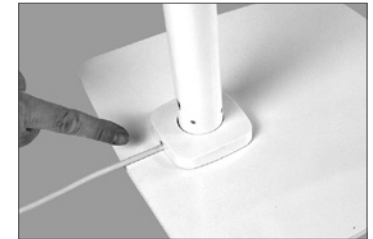

Option 2: Through Mount

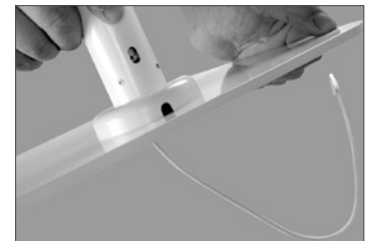

NOTE 2: Center your Mount Arm

The mount arm should be positioned so that the center point of its rotation is located appropriately for your installation scenario.

You can determine the center point by aligning the openings on the rear of the tube with the 2 screws visible through the openings (see below).

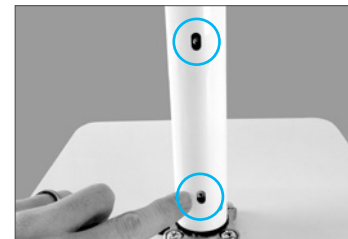

ASSEMBLY INSTRUCTIONS

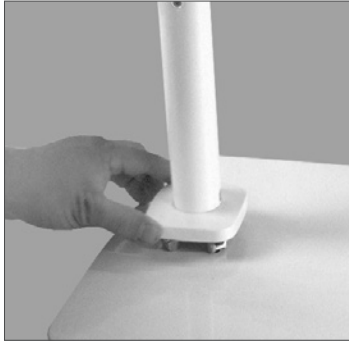

- 2. Fit foot cover** over screws (velcro will hold it in place once positioned).



- 5. Fit screw opening caps.** Once you have adjusted the tension and degree of rotation, fit the included plastic screw caps to conceal the screw openings.

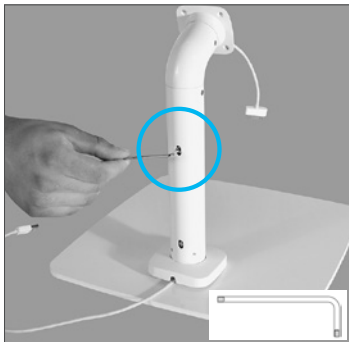

- 3. Set rotation tension.** To disable rotation (and/ or adjust rotation tension) tighten the screw in the upper rear opening of the vertical tube to the desired level with the **long silver L Key** provided.

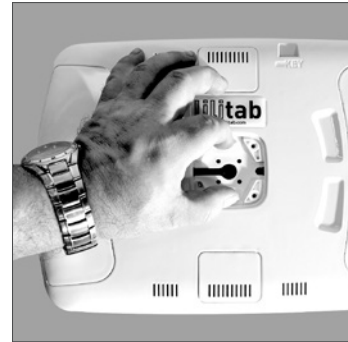

- 6. Open the lilitab head unit** by placing it facedown on a clean surface and squeezing the finger latches together as shown. Carefully lift up and the faceplate will release, allowing access to the inside of the head unit.

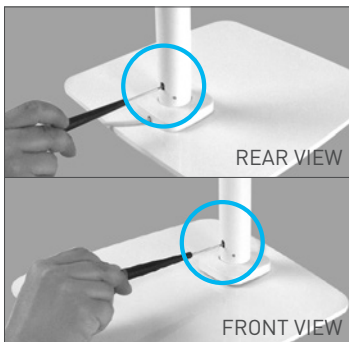

- 4. Set degree of rotation.** The lilitab Counter Pro can be configured to allow 90°, 180° or no rotation. By default it is set to 180°
- To switch from 180° to 90° remove the **lower screw visible through the lower rear facing opening in the tube** using the **short black L Key** provided and insert it into the **threaded opening visible through the lower front opening.**



- 7. Thread the charge and sync cable** from the top of the pole through the metal plate located in the center of the lilitab head unit and pull through to the other side.

ASSEMBLY INSTRUCTIONS

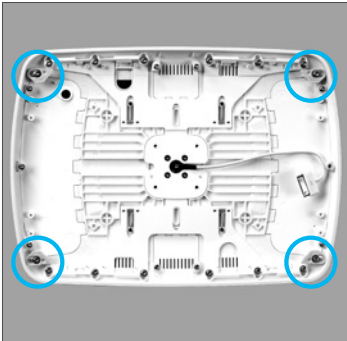

- 8. Place the head unit onto a clean surface** with the inside of the enclosure facing up (your charge and sync cable should be on the right side of the enclosure as shown in the photo). Slide all four of the green retaining clips towards the outside of the enclosure.

NOTE: The green keepers will **NOT** be present for the iPad Air, Google Nexus, Samsung Galaxy Tab 3 or Samsung Note. Instead the faceplate's locating tabs will hold the tablet in place.



- 9. Plug the charge and sync cable** into your tablet's charge port, then place your tablet inside the enclosure face up.

If your tablet's charge connector is in the middle of the long edge ensure, your charge cable is inserted into the cable routing clips as shown in photo.

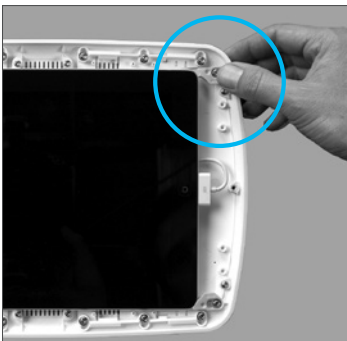

- 10. Slide all four green retaining clips** towards the center of the tablet.

NOTE: If clips aren't secure, adjust your tablet.

Lastly, position the faceplate over the tablet. Be sure to align the openings. Gently press down around the edges it will should snap into place.

NOTE: If the faceplate does not snap into place evenly ensure that all four green retaining clips are seated fully home.



- 11. Attach your lilitab head unit** to the top of pole with the **4 head mount security screws** and **long silver L key** provided.

USING THE IPAD POWER BUTTON TRIGGER

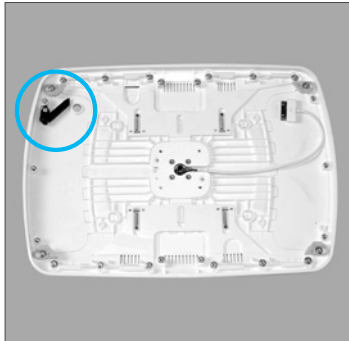

1. You can actuate the power button located on the edge of your iPad using the black Power Button Trigger shown to the left.



NOTE: Here's an iPad installed in the correct orientation with the Power Button Trigger next to the iPad's power button.

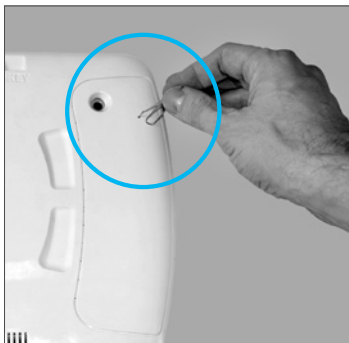

2. Once installed you can actuate the Power Button Trigger via a paper clip inserted into the small opening on the rear below the camera opening.

USING THE MAGKEY



1. You can use the included MagKey with an iPad 2,3 or 4 in your lilitab. The MagKey allows you to sleep the iPad without having any access to it. This ensures you (and your staff!) can turn your kiosk on and off at the end of the day without removing the iPad from the kiosk. You will always know when the iPad is sleeping because once inserted the MagKey pokes out the top of unit like a little flag.



2. To sleep your iPad simply insert your MagKey with the orange side facing front and the black side facing back.



3. Remove your MagKey and your lilitab will wake up, in exactly the same state it was in before it went to bed ;-)

NOTE: The MagKey is compatible with iPad 2, 3 and 4. It requires that the iPad Cover Lock/Unlock preference is turned on. You can find this in Settings→ General→ iPad Cover Lock/Unlock.

Replacement MagKeys can be ordered directly from the website: www.lilitab.com

LILITAB CLEANING INSTRUCTIONS



1. **Spray** the Brillianize onto one of the cloths provided.

WARNING: Other cloth/material may mar the surface of your lilitab



2. **DO NOT spray directly onto your lilitab!**



3. **Rub gently** in a circular motion to remove fingerprints and dirt.

WARNING: Applying excess pressure can mar the surface of your lilitab.

lilitab

QUESTIONS?

We're here to help!

EMAIL: support@lilitab.com

PHONE: (888) 705 0190