

lilitab **Surface Basic**

Packing List and Assembly Instructions

v.1.0

TABLE OF CONTENTS

LILITAB SURFACE BASIC PACKAGING AND ASSEMBLY INSTRUCTIONS

| | |
|---|---|
| lilitab Surface Basic Assembly Preparation | 3 |
| lilitab Surface Basic Features | 4 |
| lilitab Surface Basic Mount Options | 5 |
| lilitab Surface Basic Mounting Pattern | 6 |
| lilitab Surface Basic Assembly Instructions | 7 |
| lilitab Surface Basic Using Your MagKey | 9 |

ASSEMBLY PREPARATION

TO ASSEMBLE YOUR LILITAB YOU WILL NEED:

- ✓ Phillips screwdriver

TO MOUNT YOUR LILITAB TO A SURFACE YOU WILL NEED:

- ✓ Powered drill/driver, preferably with impact action
- ✓ 4 x bolts or wood screws (m5, no.10, no.11, 3/16" or 13/64 diameter)

PACKING LIST

1 x head unit & faceplate

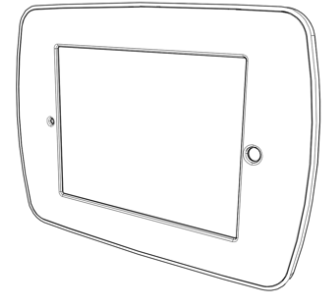

1 x mount arm

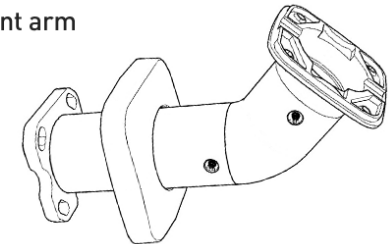

1 x MagKey



4 x pole mount screws

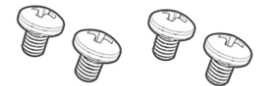

head unit security screws



1 x security L key (silver)



FEATURES

WIRELESS TRANSPARENCY

The lilitab head unit causes no radio interference.

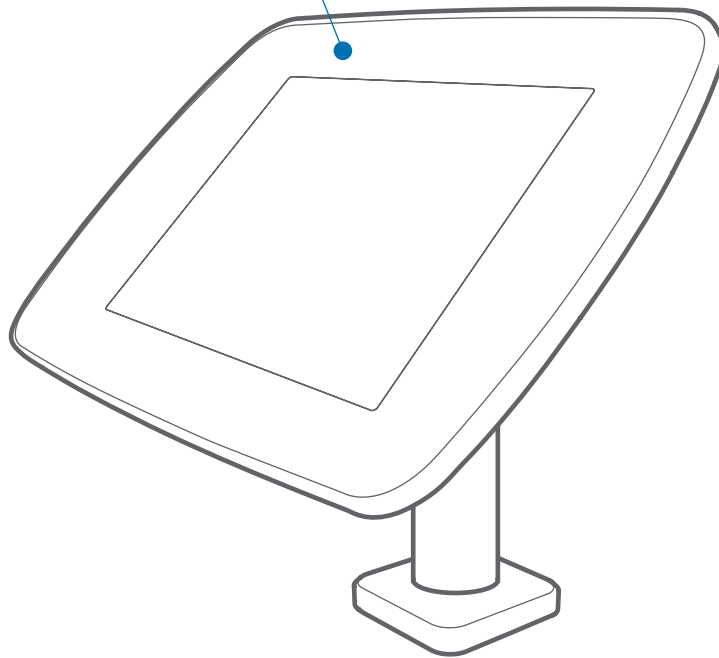

MAGKEY

MAGKEY SLOT

Accepts a MagKey for securely sleeping an iPad.

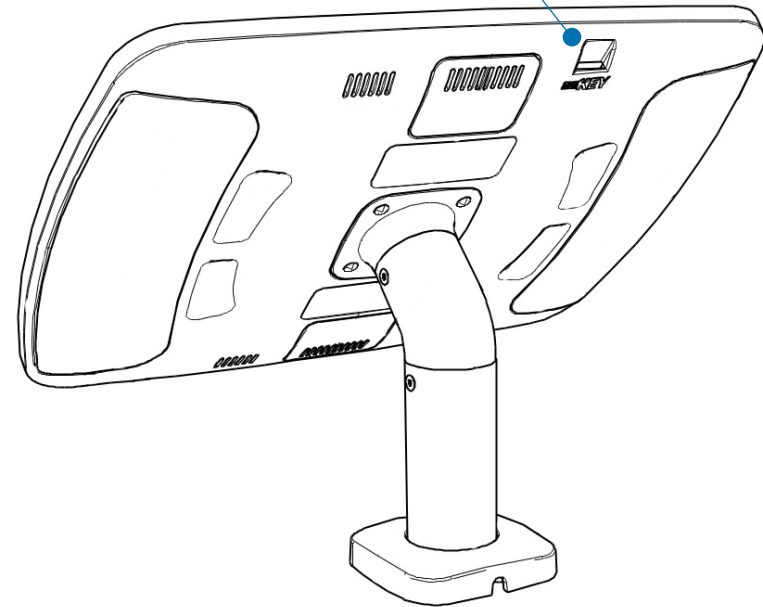

MOUNT OPTIONS

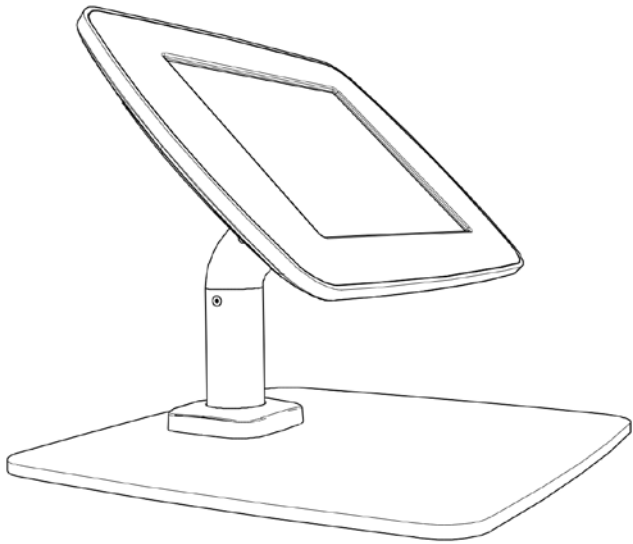

COUNTER TOP WITH OPTIONAL BASE PLATE

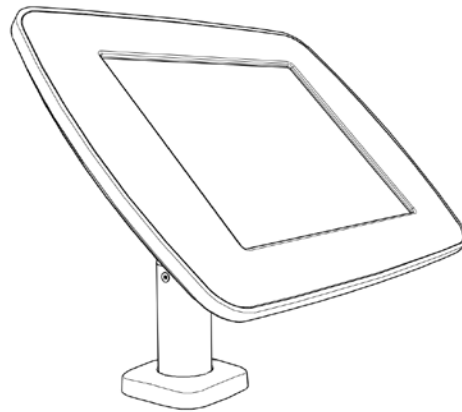

BOLT DIRECTLY TO HORIZONTAL SURFACE

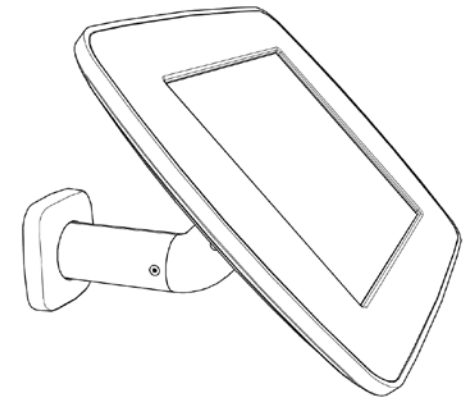

BOLT DIRECTLY TO VERTICAL SURFACE

ASSEMBLY INSTRUCTIONS

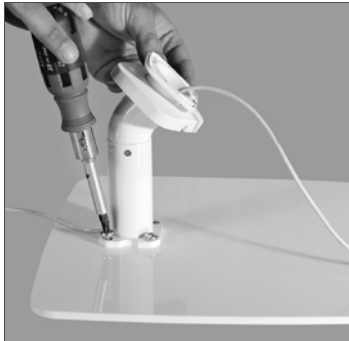

- 1. Attaching directly to a counter or wall:** If you are not using a baseplate and instead attaching your unit directly to a surface you will need to obtain 4 fasteners suitable for your substrate. Use the mount pattern provided on page 6 of this document to mark your screw openings.

Attaching to the optional baseplate: Use the 4 large m6x8 screws to bolt your unit to the baseplate.



- 2. Fit foot cover** over screws (velcro will hold it in place once positioned).

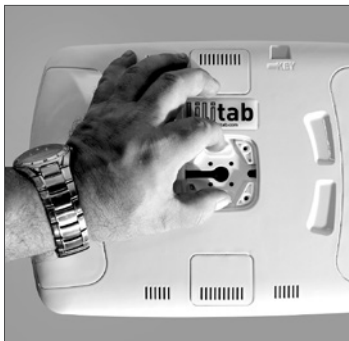

- 3. Open the lilitab head unit** by placing it facedown on a clean surface and squeezing the finger latches together as shown. Carefully lift up and the faceplate will come off, allowing access to the inside of the head unit.



- 4. Install the charge and sync cable** that came with your tablet into the head unit by threading it through the metal plate located in the center of the head unit.

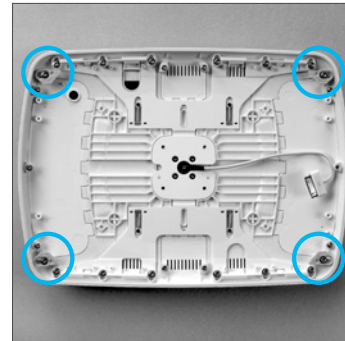

- 5. Place the head unit onto a clean surface** with the inside of the enclosure facing up (the lilitab logo on the rear of the unit will face down and away from you). Slide all four of the green retaining clips towards the outside of the enclosure.

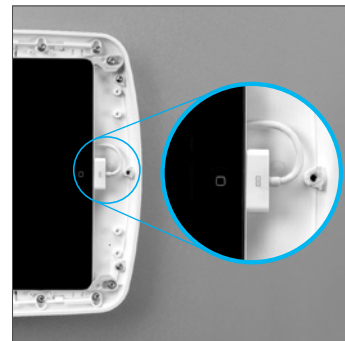

- 6. Plug the cable** that came with your tablet's into its charge port and place it inside the enclosure face up (screen faces towards you).

ASSEMBLY INSTRUCTIONS



- 7. Slide all four green retaining clips** towards the center of the tablet ensuring they securely hold the tablet in place.

NOTE: You may need to adjust the position of the tablet slightly to allow all four clips to slide home properly.



- 8. Position the faceplate** over the tablet such that its openings are oriented as you wish (faceplates have different combinations of home button and camera openings). Gently press down around the edge of the faceplate and it will snap into place.

NOTE: If the faceplate does not snap into place evenly (or if one or more corners is lifting up) ensure that all four of the green retaining clips are seated fully home

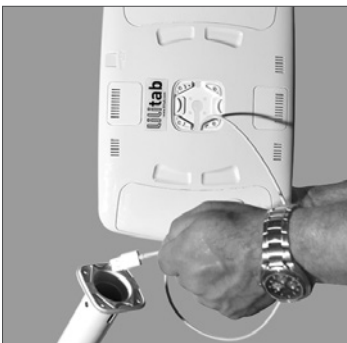

- 9. Thread the charge and sync cable** that came with your tablet through the top of your lilitab mount.



- 10. Attach your lilitab head unit** to the top of your mount via the 4 security screws provided (a security L key is provided with your mount for this purpose).

USING YOUR MAGKEY



1. You can use the included MagKey with an iPad 2,3 or 4 in your lilitab. The MagKey allows you to sleep the iPad without having any access to it. This ensures you (and your staff!) can turn your kiosk on and off at the end of the day without removing the iPad from the kiosk. You will always know when the iPad is sleeping because once inserted the MagKey pokes out the top of unit like a little flag.



2. To sleep your iPad simply insert your MagKey with the orange side facing front and the black side facing back.



3. Remove your MagKey and your lilitab will wake up, in exactly the same state it was in before it went to bed ;-)

NOTE: The MagKey will work on any iPad® 2 or newer. It requires that the iPad Cover Lock/Unlock preference is turned on. You can find this in Settings→ General→ iPad Cover Lock/Unlock.

Replacement MagKeys can be ordered directly from the website: www.lilitab.com

Cleaning and caring for your lilitab.

To keep your lilitab looking and working great we recommend using a lint-free cloth to gently wipe it down.

To remove and prevent fingerprints we recommend Brillianize.

DO NOT use window cleaner, ammonia-based cleaners or any type of scouring or abrasive cleaner.



QUESTIONS?

We're here to help!

EMAIL: support@lilitab.com

PHONE: (888) 705 0190